

FEATURES

Triaxial, digital gyroscope

$\pm 125^\circ/\text{sec}$, $\pm 500^\circ/\text{sec}$, $\pm 2000^\circ/\text{sec}$ dynamic range models

2.3°/hr in-run bias stability (ADIS16505-1)

0.13°/√hr angular random walk, x-axis and y-axis, 1 σ (ADIS16505-1)

$\pm 0.25^\circ$ axis to axis misalignment error

Triaxial, digital accelerometer, $\pm 78.4 \text{ m/sec}^2$ dynamic range

26.5 $\mu\text{m/sec}^2$ in-run bias stability (x-axis and y-axis)

Triaxial, delta angle and delta velocity outputs

Factory calibrated sensitivity, bias, and axial alignment

Calibration temperature range: -40°C to $+85^\circ\text{C}$

SPI compatible data communications

Programmable operation and control

Automatic and manual bias correction controls

Data ready indicator for synchronous data acquisition

External sync modes: direct, scaled, and output

On demand self-test of inertial sensors

On demand self-test of flash memory

Single-supply operation (VDD): 3.0 V to 3.6 V

14,700 m/sec^2 mechanical shock survivability

Operating temperature range: -40°C to $+105^\circ\text{C}$

APPLICATIONS

Navigation, stabilization, and instrumentation

Unmanned and autonomous vehicles

Smart agriculture and construction machinery

Factory/industrial automation, robotics

Virtual/augmented reality

Internet of Moving Things

GENERAL DESCRIPTION

The ADIS16505 is a precision, miniature microelectromechanical system (MEMS) inertial measurement unit (IMU) that includes a triaxial gyroscope and a triaxial accelerometer. Each inertial sensor in the ADIS16505 combines with signal conditioning that optimizes dynamic performance. The factory calibration characterizes each sensor for sensitivity, bias, alignment, linear acceleration (gyroscope bias), and point of percussion (accelerometer location). As a result, each sensor has dynamic compensation formulas that provide accurate sensor measurements over a broad set of conditions.

The ADIS16505 provides a simplified, cost effective method for integrating accurate, multiaxis inertial sensing into industrial systems, especially when compared with the complexity and investment associated with discrete designs. All necessary motion testing and calibration are part of the production process at the factory, greatly reducing system integration time. Tight orthogonal alignment simplifies inertial frame alignment in navigation systems. The serial peripheral interface (SPI) and register structure provide a simple interface for data collection and configuration control.

The ADIS16505 is available in a 100-ball, ball grid array (BGA) package that is approximately 15 mm \times 15 mm \times 5 mm.

FUNCTIONAL BLOCK DIAGRAM

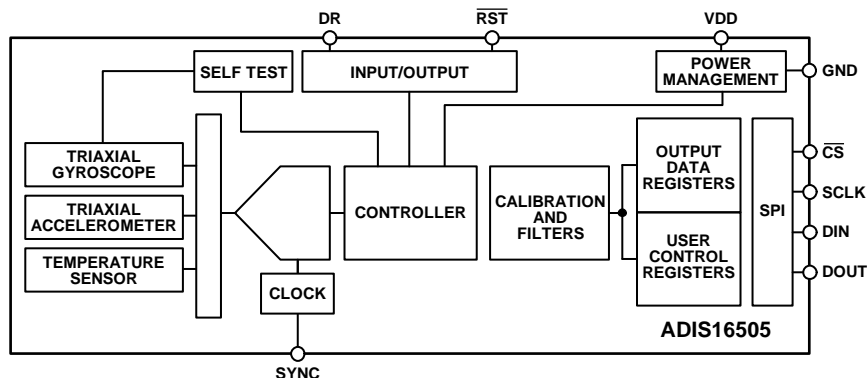

Figure 1.

Rev. A

[Document Feedback](#)

Information furnished by Analog Devices is believed to be accurate and reliable. However, no responsibility is assumed by Analog Devices for its use, nor for any infringements of patents or other rights of third parties that may result from its use. Specifications subject to change without notice. No license is granted by implication or otherwise under any patent or patent rights of Analog Devices. Trademarks and registered trademarks are the property of their respective owners.

One Technology Way, P.O. Box 9106, Norwood, MA 02062-9106, U.S.A.
Tel: 781.329.4700

©2019 Analog Devices, Inc. All rights reserved.

[Technical Support](#)

www.analog.com

TABLE OF CONTENTS

| | | | |
|--|----|--|----|
| Features | 1 | SPI..... | 17 |
| Applications..... | 1 | Data Ready (DR) | 17 |
| General Description | 1 | Reading Sensor Data..... | 18 |
| Functional Block Diagram | 1 | Burst Read Function | 19 |
| Revision History | 2 | Latency..... | 21 |
| Specifications..... | 3 | Device Configuration | 21 |
| Timing Specifications | 6 | Memory Structure | 21 |
| Absolute Maximum Ratings | 7 | User Register Memory Map | 22 |
| Thermal Resistance | 7 | User Register Defintions..... | 24 |
| ESD Caution..... | 7 | Gyroscope Data | 24 |
| Pin Configuration and Function Descriptions..... | 8 | Delta Angles | 28 |
| Typical Performance Characteristics | 11 | Delta Velocity..... | 29 |
| Gyroscopes | 11 | Calibration..... | 31 |
| Accelerometers..... | 14 | Applications Information | 38 |
| Theory of Operation | 15 | Assembly and Handling Tips..... | 38 |
| Introduction | 15 | Power Supply Considerations..... | 39 |
| Clock Control..... | 15 | Evaluation Tools | 39 |
| Bartlett Window Filter | 16 | Packaging and Ordering Information | 41 |
| Calibration..... | 16 | Outline Dimensions..... | 41 |
| Decimation Filter..... | 16 | Ordering Guide | 41 |
| Register Structure | 16 | | |

REVISION HISTORY

10/2019—Revision A: Initial Version

SPECIFICATIONS

Case temperature (T_c) = 25°C, VDD = 3.3 V, angular rate = 0°/sec, and dynamic range = $\pm 2000^\circ/\text{sec} \pm 1g$, unless otherwise noted. 1 g is the acceleration due to gravity and assumed to be 9.8 m/sec².

Table 1.

| Parameter | Test Conditions/Comments | Min | Typ | Max | Unit |
|---------------------------------|--|------------|----------------------|-----|--|
| GYROSCOPES | | | | | |
| Dynamic Range | ADIS16505-1 | ± 125 | | | °/sec |
| | ADIS16505-2 | ± 500 | | | °/sec |
| | ADIS16505-3 | ± 2000 | | | °/sec |
| Sensitivity | ADIS16505-1, 16-bit data format | | 160 | | LSB/°/sec |
| | ADIS16505-2, 16-bit data format | | 40 | | LSB/°/sec |
| | ADIS16505-3, 16-bit data format | | 10 | | LSB/°/sec |
| | ADIS16505-1, 32-bit data format | | 10,485,760 | | LSB/°/sec |
| | ADIS16505-2, 32-bit data format | | 2,621,440 | | LSB/°/sec |
| | ADIS16505-3, 32-bit data format | | 655,360 | | LSB/°/sec |
| Error over Temperature | ADIS16505-1, $-40^\circ\text{C} \leq T_c \leq +85^\circ\text{C}$, 1 σ | | ± 0.5 | | % |
| | ADIS16505-2, $-40^\circ\text{C} \leq T_c \leq +85^\circ\text{C}$, 1 σ | | ± 0.5 | | % |
| | ADIS16505-3, $-40^\circ\text{C} \leq T_c \leq +85^\circ\text{C}$, 1 σ | | ± 0.3 | | % |
| Misalignment Error | Axis to axis, $-40^\circ\text{C} \leq T_c \leq +85^\circ\text{C}$, 1 σ | | ± 0.25 | | Degrees |
| Nonlinearity ¹ | ADIS16505-1, full scale (FS) = 125°/sec | | 0.2 | | %FS |
| | ADIS16505-2, FS = 500°/sec | | 0.2 | | %FS |
| | ADIS16505-3, FS = 2000°/sec | | 0.2 | | %FS |
| Bias | | | | | |
| Repeatability ² | $-40^\circ\text{C} \leq T_c \leq +85^\circ\text{C}$, 1 σ , x-axis and z-axis | | 0.14 | | °/sec |
| | $-40^\circ\text{C} \leq T_c \leq +85^\circ\text{C}$, 1 σ , y-axis | | 1.4 | | °/sec |
| In-Run Bias Stability | ADIS16505-1, 1 σ | | 2.3 | | °/hr |
| | ADIS16505-2, 1 σ | | 2.7 | | °/hr |
| | ADIS16505-3, 1 σ | | 8.1 | | °/hr |
| Angular Random Walk | ADIS16505-1, x-axis and y-axis, 1 σ | | 0.13 | | °/√hr |
| | ADIS16505-1, z-axis, 1 σ | | 0.19 | | °/√hr |
| | ADIS16505-2, x-axis and y-axis, 1 σ | | 0.15 | | °/√hr |
| | ADIS16505-2, z-axis, 1 σ | | 0.2 | | °/√hr |
| | ADIS16505-3, x-axis and y-axis, 1 σ | | 0.29 | | °/√hr |
| | ADIS16505-3, z-axis, 1 σ | | 0.32 | | °/√hr |
| Error over Temperature | $-40^\circ\text{C} \leq T_c \leq +85^\circ\text{C}$, 1 σ , x-axis and z-axis | | ± 0.3 | | °/sec |
| | $-40^\circ\text{C} \leq T_c \leq +85^\circ\text{C}$, 1 σ , y-axis | | ± 0.7 | | °/sec |
| Linear Acceleration Effect | Any direction, 1 σ | | 867×10^{-6} | | (°/sec)/(m/sec ²) |
| Vibration Rectified Error (VRE) | Random vibration, 19.6 m/sec ² rms, 50 Hz to 2 kHz | | 3.6×10^{-6} | | (°/sec)/(m/sec ²) ² |
| Output Noise | No filtering, 1 σ , 25°C | | | | |
| | ADIS16505-1, x-axis, y-axis | | 68×10^{-3} | | °/sec rms |
| | ADIS16505-1, z-axis | | 104×10^{-3} | | °/sec rms |
| | ADIS16505-2, x-axis, y-axis | | 82×10^{-3} | | °/sec rms |
| | ADIS16505-2, z-axis | | 116×10^{-3} | | °/sec rms |
| | ADIS16505-3, all axes | | 152×10^{-3} | | °/sec rms |
| Rate Noise Density | Frequency = 10 Hz to 40 Hz | | | | |
| | ADIS16505-1, x-axis and y-axis | | | | °/sec/√Hz rms |
| | ADIS16505-1, z-axis | | 3.0×10^{-3} | | °/sec/√Hz rms |
| | ADIS16505-2, x-axis and y-axis | | 4.3×10^{-3} | | °/sec/√Hz rms |
| | ADIS16505-2, z-axis | | 3.4×10^{-3} | | °/sec/√Hz rms |

| Parameter | Test Conditions/Comments | Min | Typ | Max | Unit | |
|------------------------------------|--|--------------------------|---------------------------|-----------------------|---|---------------|
| 3 dB Bandwidth | ADIS16505-3, x-axis and y-axis | | 4.6×10^{-3} | | $^{\circ}/\text{sec}/\sqrt{\text{Hz}}$ rms | |
| | ADIS16505-3, z axis | | 6.1×10^{-3} | | $^{\circ}/\text{sec}/\sqrt{\text{Hz}}$ rms | |
| | ADIS16505-1, ADIS16505-2, x-axis and y-axis | | 480 | | Hz | |
| | ADIS16505-1, ADIS16505-2, z-axis | | 590 | | Hz | |
| | ADIS16505-3, x-axis and y-axis | | 573 | | Hz | |
| | ADIS16505-3, z-axis | | 639 | | Hz | |
| Sensor Resonant Frequency | X-axis, y-axis | | 66 | | kHz | |
| | Z-axis | | 78 | | kHz | |
| | | | | | | |
| ACCELEROMETERS ³ | Each axis | | | | | |
| Dynamic Range | | ± 78.4 | | | m/sec ² | |
| Sensitivity | 32-bit data format | | 26,756,268 | | LSB/(m/sec ²) | |
| Error over Temperature | $-40^{\circ}\text{C} \leq T_c \leq +85^{\circ}\text{C}$, 1 σ | | ± 0.07 | | % | |
| Repeatability ² | $-40^{\circ}\text{C} \leq T_c \leq +85^{\circ}\text{C}$, 1 σ | | ± 0.1 | | % | |
| Misalignment Error | Axis to axis, $-40^{\circ}\text{C} \leq T_c \leq +85^{\circ}\text{C}$, 1 σ | | ± 0.05 | | Degrees | |
| Nonlinearity | Best fit straight line, ± 19.6 m/sec ² | | 0.25 | | %FS | |
| | Best fit straight line, ± 78.4 m/sec ² , x-axis | | 0.5 | | %FS | |
| | Best fit straight line, ± 78.4 m/sec ² , y-axis and z-axis | | 1.5 | | %FS | |
| Bias | | | | | | |
| Repeatability ² | $-40^{\circ}\text{C} \leq T_c \leq +85^{\circ}\text{C}$, 1 σ | | 19.6×10^{-3} | | m/sec ² | |
| In-Run Bias Stability | 1 σ | | | | | |
| | | X-Axis and Y-Axis | | 26.5×10^{-6} | m/sec ² | |
| | | Z-Axis | | 43.1×10^{-6} | m/sec ² | |
| Velocity Random Walk | 1 σ | | | | | |
| | | X-Axis and Y-Axis | | 0.009 | m/sec/ $\sqrt{\text{hr}}$ | |
| Z-Axis | | 0.012 | m/sec/ $\sqrt{\text{hr}}$ | | | |
| Error over Temperature | $-40^{\circ}\text{C} \leq T_c \leq +85^{\circ}\text{C}$, 1 σ | | $\pm 9.8 \times 10^{-3}$ | | m/sec ² | |
| Output Noise | No filtering | | | | | |
| | | X-Axis and Y-Axis | | 4.8×10^{-3} | m/sec ² rms | |
| | | Z-Axis | | 6.07×10^{-3} | m/sec ² rms | |
| Noise Density | f = 10 Hz to 40 Hz, no filtering | | | | | |
| | | X-Axis and Y-Axis | | 167×10^{-6} | m/sec ² / $\sqrt{\text{Hz}}$ rms | |
| | | Z-Axis | | 243×10^{-6} | m/sec ² / $\sqrt{\text{Hz}}$ rms | |
| 3 dB Bandwidth | | | 750 | | Hz | |
| Sensor Resonant Frequency | Y-axis and z-axis | | 2.4 | | kHz | |
| | X-axis | | 2.2 | | kHz | |
| TEMPERATURE SENSOR | | | | | | |
| Scale Factor | Output = 0x0000 at 0°C ($\pm 5^{\circ}\text{C}$) | | 0.1 | | $^{\circ}\text{C}/\text{LSB}$ | |
| LOGIC INPUTS ⁴ | | | | | | |
| Input Voltage | | | | | | |
| | | High, V _{IH} | 2.0 | | V | |
| Low, V _{IL} | | | | 0.8 | V | |
| RST Pulse Width | | 1 | | | μs | |
| CS Wake-Up Pulse Width | | 20 | | | μs | |
| Input Current | V _{IH} = 3.3 V V _{IL} = 0 V | | | | | |
| | | Logic 1, I _{IH} | | | 10 | μA |
| | | Logic 0, I _{IL} | | | 10 | μA |
| All Pins Except RST | | | | | μA | |
| RST Pin | | | 0.33 | | mA | |
| Input Capacitance, C _{IN} | | | 10 | | pF | |

| Parameter | Test Conditions/Comments | Min | Typ | Max | Unit |
|------------------------------------|--|--------|------|-----|--------|
| DIGITAL OUTPUTS | | | | | |
| Output Voltage | | | | | |
| High, V_{OH} | Source current (I_{SOURCE}) = 0.5 mA | 2.4 | | | V |
| Low, V_{OL} | Sink current (I_{SINK}) = 2.0 mA | | | 0.4 | V |
| FLASH MEMORY | | | | | |
| Data Retention ⁶ | Endurance ⁵ $T_J = 85^\circ\text{C}$ | 10,000 | | | Cycles |
| | | 20 | | | Years |
| FUNCTIONAL TIMES ⁷ | Time until data is available | | | | |
| Power-On Start-Up Time | | | 310 | | ms |
| Reset Recovery Time ⁸ | GLOB_CMD, Bit 7 = 1 (see Table 114) | | 255 | | ms |
| Factory Calibration Restore | GLOB_CMD, Bit 1 = 1 (see Table 114) | | 136 | | ms |
| Flash Memory Backup | GLOB_CMD, Bit 3 = 1 (see Table 114) | | 70 | | ms |
| Flash Memory Test Time | GLOB_CMD, Bit 4 = 1 (see Table 114) | | 30 | | ms |
| Self Test Time ⁹ | GLOB_CMD, Bit 2 = 1 (see Table 114) | | 24 | | ms |
| CONVERSION RATE | | | 2000 | | SPS |
| Initial Clock Accuracy | | | 3 | | % |
| Sync Input Clock | | 1.9 | | 2.1 | kHz |
| POWER SUPPLY, VDD | | | | | |
| Operating voltage range | Operating voltage range | 3.0 | | 3.6 | V |
| Power Supply Current ¹⁰ | Normal mode, VDD = 3.3 V | | 44 | 55 | mA |

¹ This measurement is based on the deviation from a best fit linear model.

² Bias repeatability provides an estimate for long-term drift in the bias, as observed during 500 hours of high temperature operating life (HTOL) at 105°C.

³ All specifications associated with the accelerometers relate to the full-scale range of $\pm 8 g$, unless otherwise noted.

⁴ The digital input/output signals use a 3.3 V system.

⁵ Endurance is qualified as per JEDEC Standard 22, Method A117, measured at -40°C , $+25^\circ\text{C}$, $+85^\circ\text{C}$, and $+125^\circ\text{C}$.

⁶ The data retention specification assumes a junction temperature (T_J) of 85°C per JEDEC Standard 22, Method A117. Data retention lifetime decreases with T_J .

⁷ These times do not include thermal settling and internal filter response times, which may affect overall accuracy.

⁸ The $\overline{\text{RST}}$ line must be in a low state for at least 10 μs to ensure a proper reset initiation and recovery.

⁹ The self test time can extend when using external clock rates lower than 2000 Hz.

¹⁰ Power supply current transients can reach 100 mA during initial startup or reset recovery.

TIMING SPECIFICATIONS

T_A = 25°C, VDD = 3.3 V, unless otherwise noted.

Table 2.

| Parameter | Description | Normal Mode | | | Burst Read Mode | | | Unit |
|---|---|-------------|-----|------|------------------|-----|------|------|
| | | Min | Typ | Max | Min | Typ | Max | |
| f _{SCLK} | Serial clock | 0.1 | | 2.1 | 0.1 | | 1.1 | MHz |
| t _{STALL} | Stall period between data | 16 | | | N/A ¹ | | | μs |
| t _{READRATE} | Read rate | 24 | | | | | | μs |
| t _{CS} | Chip select to SCLK edge | 200 | | | 200 | | | ns |
| t _{DAV} | DOUT valid after SCLK edge | | | 25 | | | 25 | ns |
| t _{DSU} | DIN setup time before SCLK rising edge | 25 | | | 25 | | | ns |
| t _{DHD} | DIN hold time after SCLK rising edge | 50 | | | 50 | | | ns |
| t _{SCLKR} , t _{SCLKF} | SCLK rise/fall times | | 5 | 12.5 | | 5 | 12.5 | ns |
| t _{DR} , t _{DF} | DOUT rise/fall times | | 5 | 12.5 | | 5 | 12.5 | ns |
| t _{SFS} | CS high after SCLK edge | 0 | | | 0 | | | ns |
| t ₁ | Input sync positive pulse width; direct sync mode, MSC_CTRL[3:2] = 01 (binary, see Table 106) | 5 | | | 5 | | | μs |
| t _{STDR} | Input sync to data ready valid transition, no SPI traffic, direct sync mode, MSC_CTRL[3:2] = 01 (binary, see Table 106) | | 305 | | | 305 | | μs |
| | Input sync to data ready valid transition, full SPI traffic ² , direct sync mode, MSC_CTRL[3:2] = 01 (binary, see Table 106) | | 405 | | | 405 | | μs |
| t _{NV} | Data invalid time | | 23 | | | 23 | | μs |
| t ₂ | Input sync period | 500 | | | 500 | | | μs |

¹ N/A means not applicable.

² Full SPI traffic is defined as a transfer of 64 16-bit registers using an SCLK frequency of 2 MHz. Reading the sensor values from the previous data sample proportionally increases the t_{STDR} on the current cycle.

Timing Diagrams

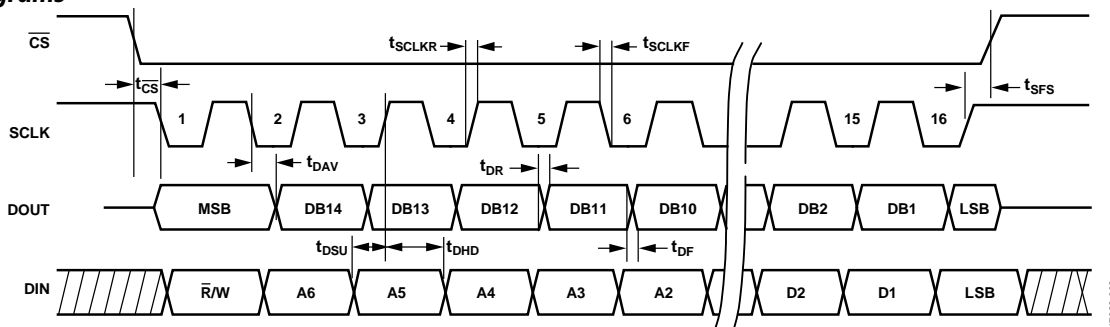

Figure 2. SPI Timing and Sequence Diagram

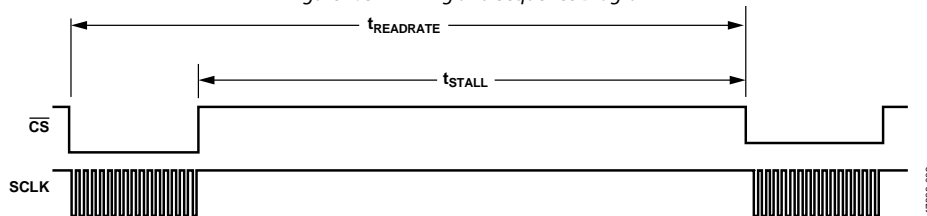

Figure 3. Stall Time and Data Rate Timing Diagram

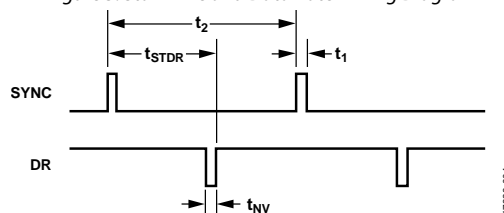

Figure 4. Input Clock Timing Diagram, Direct Sync Mode, Register MSC_CTRL[3:2] = 01 (Binary)

ABSOLUTE MAXIMUM RATINGS

Table 3.

| Parameter | Rating |
|---|---------------------------|
| Mechanical Shock Survivability Any Axis, Unpowered, 0.5 ms | 14,700 m/sec ² |
| VDD to GND | −0.3 V to +3.6 V |
| Digital Input Voltage to GND | −0.3 V to VDD + 0.2 V |
| Digital Output Voltage to GND | −0.3 V to VDD + 0.2 V |
| Temperature Range | |
| Calibration | −40°C to +85°C |
| Operating | −40°C to +105°C |
| Storage ¹ | −65°C to +150°C |
| Barometric Pressure | 2 bar |

¹ Extended exposure to temperatures that are lower than −20°C or higher than +85°C can adversely affect the accuracy of the factory calibration.

Stresses at or above those listed under Absolute Maximum Ratings may cause permanent damage to the product. This is a stress rating only; functional operation of the product at these or any other conditions above those indicated in the operational section of this specification is not implied. Operation beyond the maximum operating conditions for extended periods may affect product reliability.

THERMAL RESISTANCE

Thermal performance is directly linked to printed circuit board (PCB) design and operating environment. Careful attention to PCB thermal design is required.

The ADIS16505 is a multichip module that includes many active components. The values in Table 4 identify the thermal response of the hottest component inside of the ADIS16505, with respect to the overall power dissipation of the module. This approach enables a simple method for predicting the temperature of the hottest junction, based on either ambient or case temperature.

For example, when the ambient temperature is 70°C, the hottest junction temperature (T_J) inside of the ADIS16505 is 76.7°C.

$$T_J = \theta_{JA} \times VDD \times I_{DD} + 70^\circ\text{C}$$

$$T_J = 107.1^\circ\text{C}/\text{W} \times 3.3 \text{ V} \times 0.044 \text{ A} + 70^\circ\text{C}$$

$$T_J = 85.6^\circ\text{C}$$

Table 4. Package Characteristics

| Package Type | θ_{JA} ¹ | θ_{JC} ² | Device Weight |
|-----------------------|----------------------------|----------------------------|---------------|
| ML-100-1 ³ | 107.1°C/W | 74.7°C/W | <1.3 g |

¹ θ_{JA} is the natural convection junction to ambient thermal resistance measured in a one cubic foot sealed enclosure.

² θ_{JC} is the junction to case thermal resistance.

³ Thermal impedance values come from direct observation of the hottest temperature inside of the ADIS16505 when it is attached to an FR4-08 PCB that has two metal layers and has a thickness of 0.063 inches.

ESD CAUTION**ESD (electrostatic discharge) sensitive device.**

Charged devices and circuit boards can discharge without detection. Although this product features patented or proprietary protection circuitry, damage may occur on devices subjected to high energy ESD. Therefore, proper ESD precautions should be taken to avoid performance degradation or loss of functionality.

PIN CONFIGURATION AND FUNCTION DESCRIPTIONS

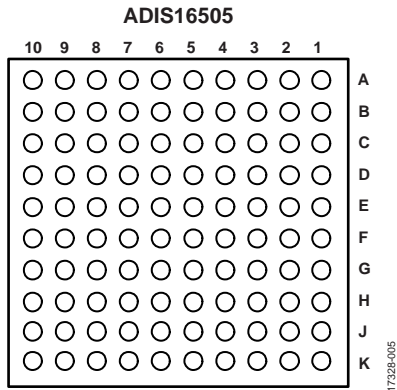

Figure 5. Pin Assignments, Bottom View

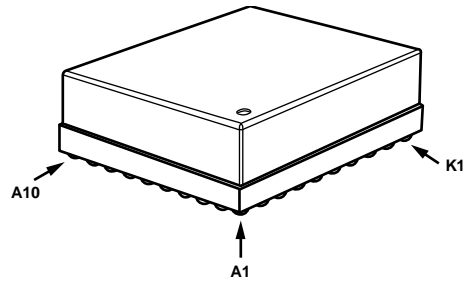

Figure 6. Pin Assignments, Package Level View

Table 5. Pin Function Descriptions

| Pin No. | Mnemonic | Type | Description |
|---------|----------|----------------|----------------|
| A1 | GND | Supply | Power Ground |
| A2 | GND | Supply | Power Ground |
| A3 | GND | Supply | Power Ground |
| A4 | GND | Supply | Power Ground |
| A5 | GND | Supply | Power Ground |
| A6 | GND | Supply | Power Ground |
| A7 | GND | Supply | Power Ground |
| A8 | GND | Supply | Power Ground |
| A9 | NC | Not applicable | No Connection |
| A10 | NC | Not applicable | No Connection |
| B1 | NC | Not applicable | No Connection |
| B2 | NC | Not applicable | No Connection |
| B3 | GND | Supply | Power Ground |
| B4 | GND | Supply | Power Ground |
| B5 | GND | Supply | Power Ground |
| B6 | GND | Supply | Power Ground |
| B7 | NC | Not applicable | No Connection |
| B8 | NC | Not applicable | No Connection |
| B9 | NC | Not applicable | No Connection |
| B10 | NC | Not applicable | No Connection |
| C1 | NC | Not applicable | No Connection |
| C2 | GND | Supply | Power Ground |
| C3 | DNC | Not applicable | Do Not Connect |
| C4 | NC | Not applicable | No Connection |
| C5 | NC | Not applicable | No Connection |
| C6 | GND | Supply | Power Ground |
| C7 | VDD | Supply | Power Supply |
| C8 | NC | Not applicable | No Connection |
| C9 | NC | Not applicable | No Connection |
| C10 | NC | Not applicable | No Connection |

| Pin No. | Mnemonic | Type | Description |
|---------|-----------------|----------------|-------------------|
| D1 | NC | Not applicable | No Connection |
| D2 | NC | Not applicable | No Connection |
| D3 | GND | Supply | Power Ground |
| D4 | NC | Not applicable | No Connection |
| D5 | NC | Not applicable | No Connection |
| D6 | VDD | Supply | Power Supply |
| D7 | NC | Not applicable | No Connection |
| D8 | NC | Not applicable | No Connection |
| D9 | NC | Not applicable | No Connection |
| D10 | NC | Not applicable | No Connection |
| E1 | NC | Not applicable | No Connection |
| E2 | GND | Supply | Power Ground |
| E3 | VDD | Supply | Power Supply |
| E4 | NC | Not applicable | No Connection |
| E5 | NC | Not applicable | No Connection |
| E6 | GND | Supply | Power Ground |
| E7 | GND | Supply | Power Ground |
| E8 | NC | Not applicable | No Connection |
| E9 | NC | Not applicable | No Connection |
| E10 | NC | Not applicable | No Connection |
| F1 | GND | Supply | Power Ground |
| F2 | NC | Not applicable | No Connection |
| F3 | RST | Input | Reset |
| F4 | NC | Not applicable | No Connection |
| F5 | GND | Supply | Power Ground |
| F6 | GND | Supply | Power Ground |
| F7 | NC | Not applicable | No Connection |
| F8 | GND | Supply | Power Ground |
| F9 | NC | Not applicable | No Connection |
| F10 | NC | Not applicable | No Connection |
| G1 | VDD | Supply | Power Supply |
| G2 | GND | Supply | Power Ground |
| G3 | \overline{CS} | Input | SPI, Chip Select |
| G4 | NC | Not applicable | No Connection |
| G5 | NC | Not applicable | No Connection |
| G6 | DIN | Input | SPI, Data Input |
| G7 | GND | Supply | Power Supply |
| G8 | NC | Not applicable | No Connection |
| G9 | NC | Not applicable | No Connection |
| G10 | NC | Not applicable | No Connection |
| H1 | VDD | Supply | Power Supply |
| H2 | NC | Not applicable | No Connection |
| H3 | DOUT | Output | SPI, Data Output |
| H4 | NC | Not applicable | No Connection |
| H5 | NC | Not applicable | No Connection |
| H6 | SCLK | Input | SPI, Serial Clock |
| H7 | NC | Not applicable | No Connection |
| H8 | GND | Supply | Power Ground |
| H9 | NC | Not applicable | No Connection |
| H10 | NC | Not applicable | No Connection |

| Pin No. | Mnemonic | Type | Description |
|---------|----------|----------------|-----------------------|
| J1 | NC | Not applicable | No Connection |
| J2 | GND | Supply | Power Ground |
| J3 | SYNC | Input | Sync (External Clock) |
| J4 | VDD | Supply | Power Supply |
| J5 | VDD | Supply | Power Supply |
| J6 | DR | Output | Data Ready |
| J7 | GND | Supply | Power Ground |
| J8 | NC | Not applicable | No Connection |
| J9 | NC | Not applicable | No Connection |
| J10 | NC | Not applicable | No Connection |
| K1 | GND | Supply | Power Ground |
| K2 | NC | Not applicable | No Connection |
| K3 | GND | Supply | Power Ground |
| K4 | NC | Not applicable | No Connection |
| K5 | NC | Not applicable | No Connection |
| K6 | VDD | Supply | Power Supply |
| K7 | NC | Not applicable | No Connection |
| K8 | GND | Supply | Power Ground |
| K9 | NC | Not applicable | No Connection |
| K10 | NC | Not applicable | No Connection |

TYPICAL PERFORMANCE CHARACTERISTICS

GYROSCOPES

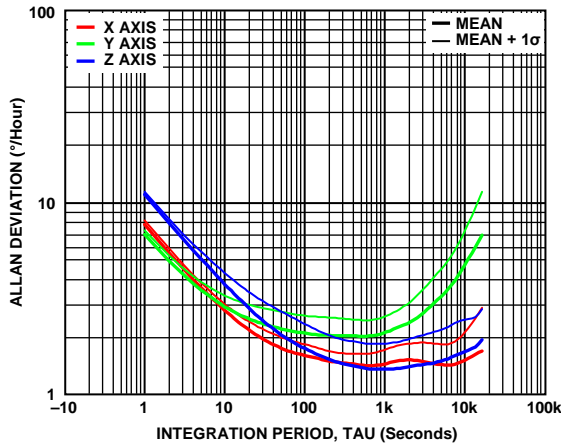

Figure 7. Gyroscope Allan Deviation, $T_C = 25^\circ\text{C}$, ADIS16505-1, Plot Taken After 10 Hours of Settling Time

17328-107

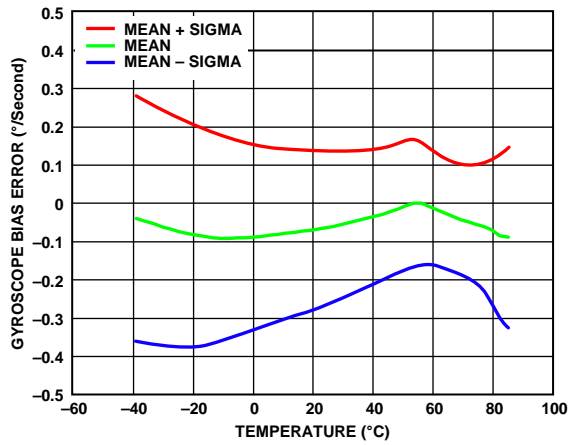

Figure 10. Gyroscope Bias Error vs. Temperature, ADIS16505-1, All Axes

17328-110

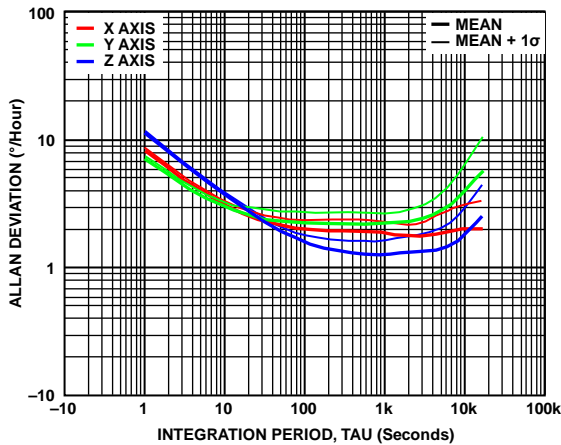

Figure 8. Gyroscope Allan Deviation, $T_C = 25^\circ\text{C}$, ADIS16505-2, Plot Taken After 10 Hours of Settling Time

17328-007

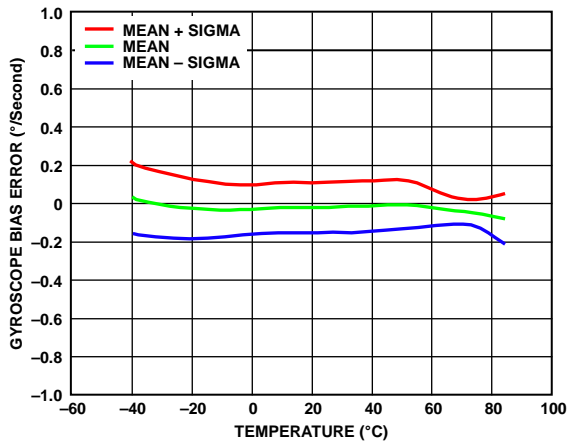

Figure 11. Gyroscope Bias Error vs. Temperature, ADIS16505-2, All Axes

17328-008

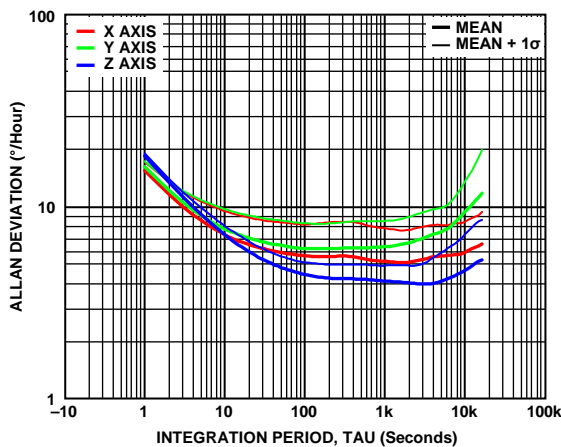

Figure 9. Gyroscope Allan Deviation, $T_C = 25^\circ\text{C}$, ADIS16505-3, Plot Taken After 10 Hours of Settling Time

17328-109

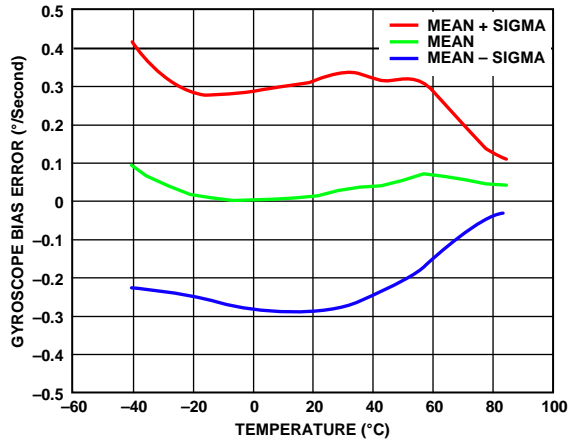

Figure 12. Gyroscope Bias Error vs. Temperature, ADIS16505-3, All Axes

17328-112

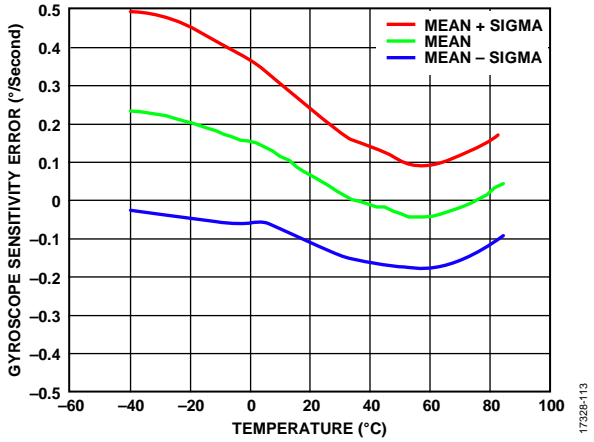

Figure 13. Gyroscope Sensitivity Error vs. Temperature, ADIS16505-1, All Axes

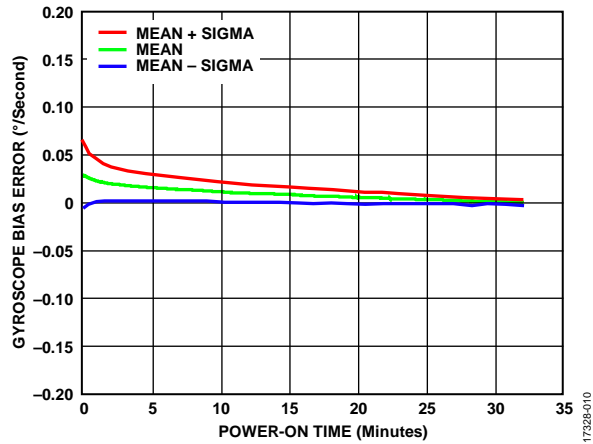

Figure 16. Gyroscope Bias Error vs. Power-On Time, $T_c = -40^\circ\text{C}$, All Axes

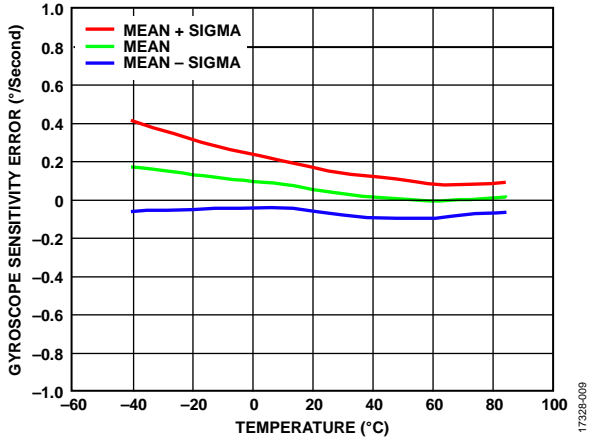

Figure 14. Gyroscope Sensitivity Error vs. Temperature, ADIS16505-2, All Axes

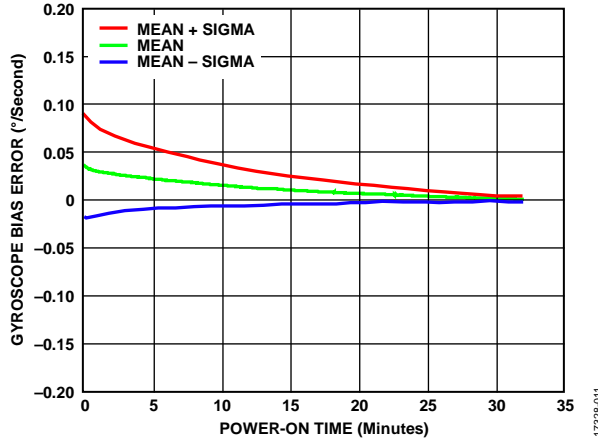

Figure 17. Gyroscope Bias Error vs. Power-On Time, $T_c = 25^\circ\text{C}$, All Axes

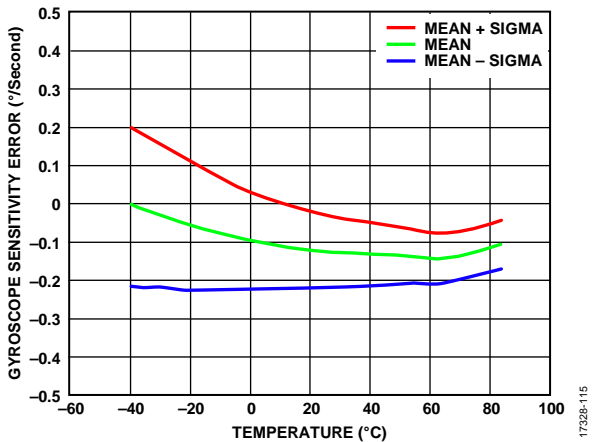

Figure 15. Gyroscope Sensitivity Error vs. Temperature, ADIS16505-3, All Axes

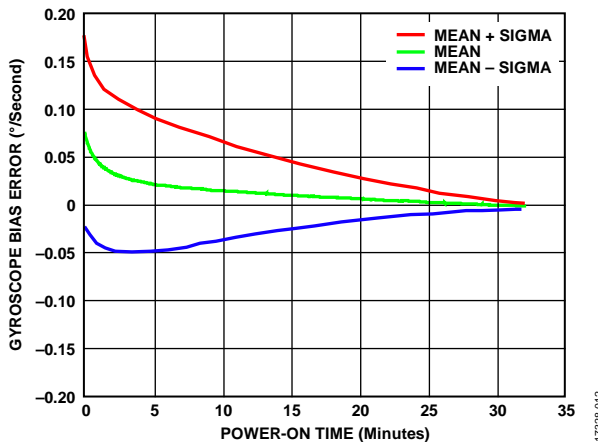

Figure 18. Gyroscope Bias Error vs. Power-On Time, $T_c = 85^\circ\text{C}$, All Axes

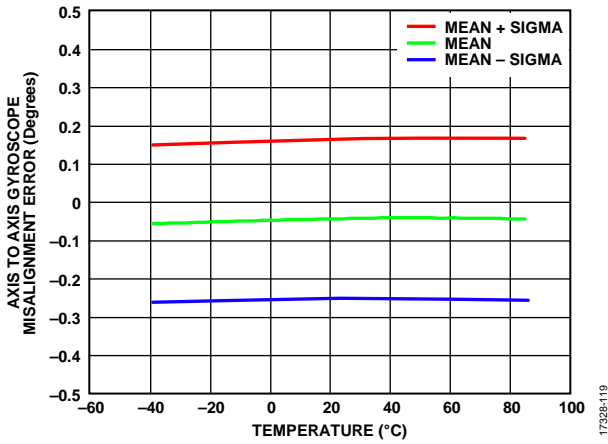

Figure 19. Axis to Axis Gyroscope Misalignment Error vs. Temperature, All Axes, ADIS16505-1

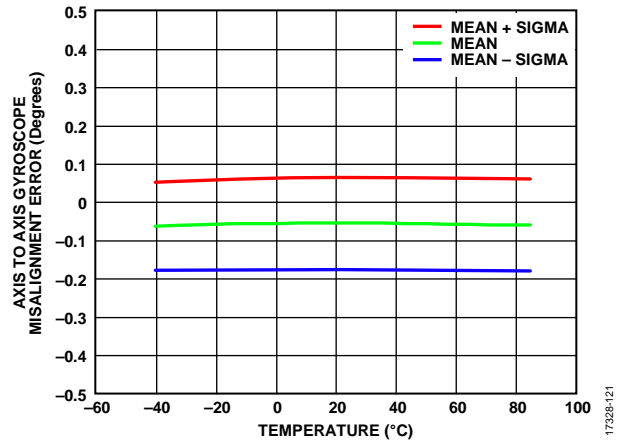

Figure 21. Axis to Axis Gyroscope Misalignment Error vs. Temperature, All Axes, ADIS16505-3

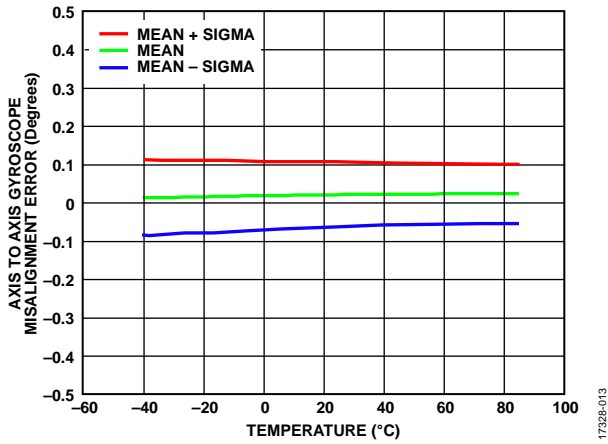

Figure 20. Axis to Axis Gyroscope Misalignment Error vs. Temperature, All Axes, ADIS16505-2

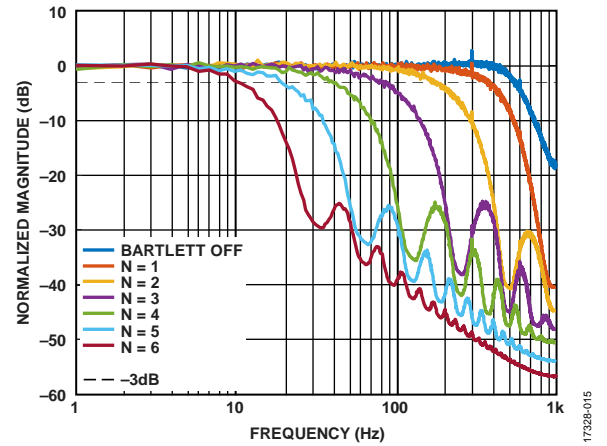

Figure 22. Normalized Gyroscope Noise Density, All Axes, $T_c = 25^\circ\text{C}$

ACCELEROMETERS

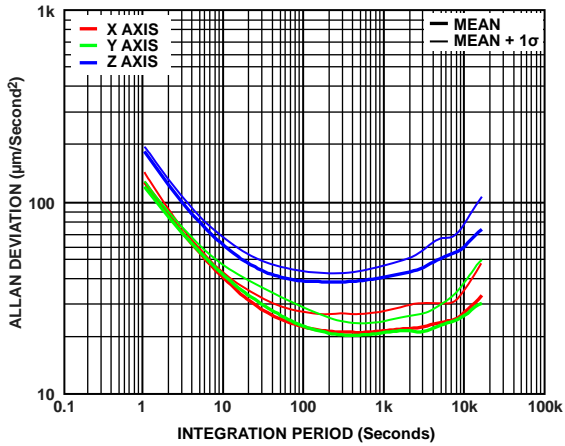

Figure 23. Accelerometer Allan Deviation, $T_C = 25^\circ\text{C}$

17328-016

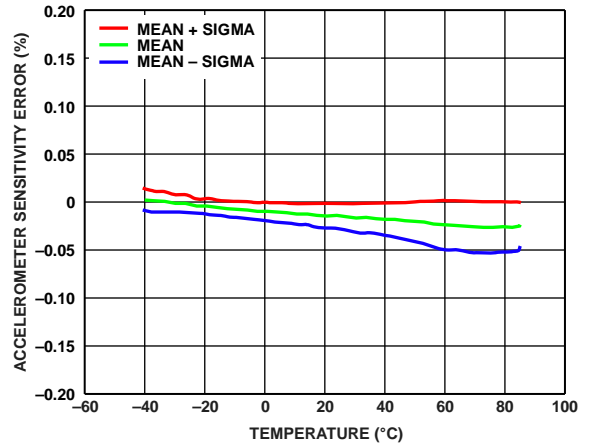

Figure 26. Accelerometer Sensitivity Error vs. Temperature, Hot to Cold, All Axes

17328-019

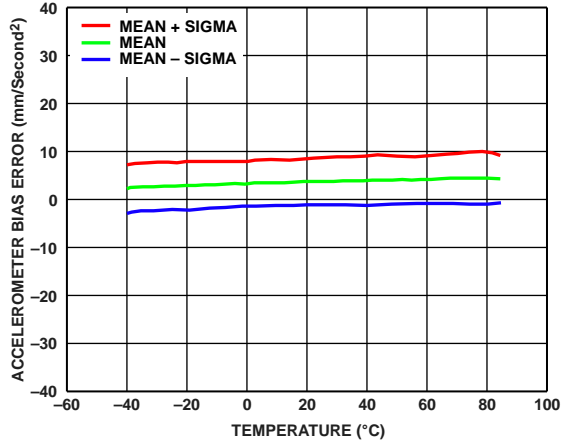

Figure 24. Accelerometer Bias Error vs. Temperature, All Axes

17328-017

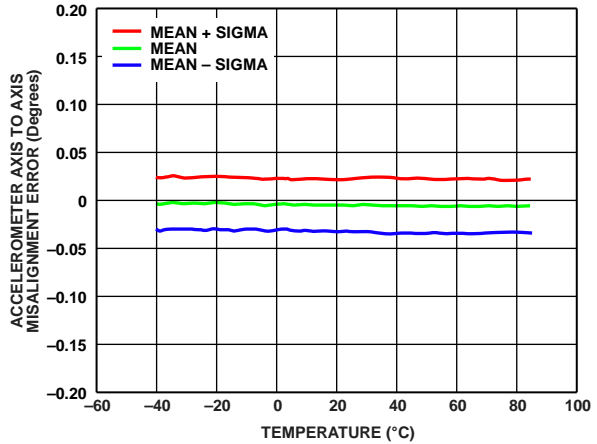

Figure 27. Accelerometer Axis to Axis Misalignment Error vs. Temperature

17328-020

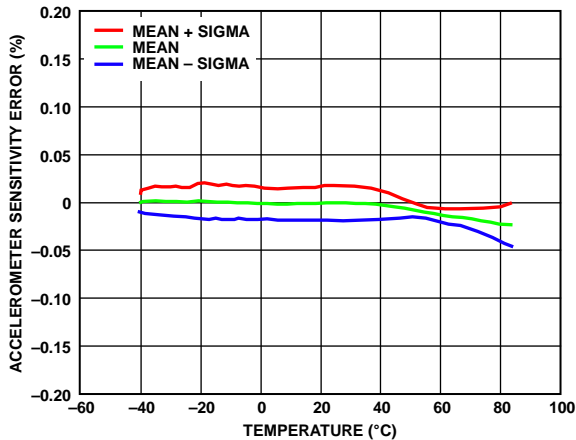

Figure 25. Accelerometer Sensitivity Error vs. Temperature, Cold to Hot, All Axes

17328-018

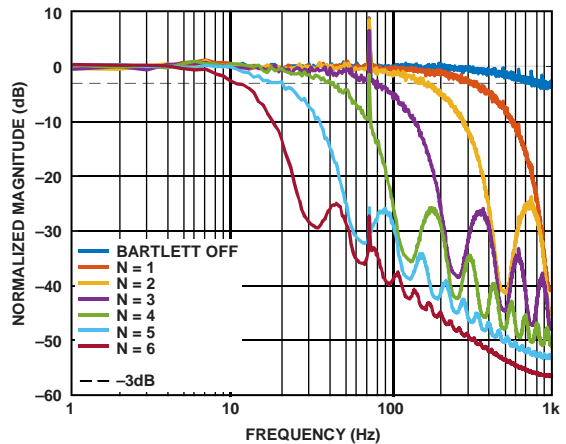

Figure 28. Accelerometer Normalized Noise Density

17328-021

THEORY OF OPERATION

INTRODUCTION

Figure 30 provides the basic signal chain for the accelerometers and gyroscopes of the ADIS16505. When using the factory default configuration, the ADIS16505 initializes itself at power-up and automatically starts a continuous process of sampling, processing, and loading calibrated sensor data into its output registers at a rate of 2000 SPS.

CLOCK CONTROL

The ADIS16505 provides four modes of operation with respect to the source of the sampling and processing clock (see the frequency sampling clock (f_{SM}) in Figure 30): internal, direct input sync, scaled sync, and output sync. The MSC_CTRL register, Bits[3:2] (see Table 105 and Table 106) provide user selection of these modes.

Internal Clock Mode

Setting MSC_CTRL register, Bits[3:2] = 00 selects the internal clock mode and is the default. In this mode, the ADIS16505 uses an internally generated clock that has a nominal frequency of 2000 Hz to drive sampling and data processing for each sensor and associated signal chain.

Direct Input Sync Mode

Setting MSC_CTRL register, Bits[3:2] = 01 selects direct input sync mode and allows f_{SM} to come directly from an external clock to control the sensor sampling using the SYNC pin as an input. When operating in input sync mode, the ADIS16505 performs best when the external clock frequency (f_{SYNC}) is between 1900 Hz and 2100 Hz.

Scaled Sync Mode

Setting MSC_CTRL register, Bits[3:2] = 10 selects scaled sync mode, which supports use of an external sync clock between 1 Hz and 128 Hz that can come from video systems or global positioning systems (GPSs). When operating in scaled sync mode, the frequency of the sample clock is equal to the product of the external clock scale factor, K_{ECSF} (from the UP_SCALE register, see Table 107 and Table 108), and the frequency of the clock signal on the SYNC pin. As in input sync mode, the ADIS16505 performs best when f_{SM} is between 1900 Hz and 2100 Hz.

Changes to the UP_SCALE register value resets the clock multiplication phase-locked loop (PLL) and restarts the locking process. The locking process starts with an input reference clock edge resetting the feedback clock edge, and lock is declared when time differences between these two edges is $\leq 100 \mu s$.

For example, when using a 1 Hz input signal, set UP_SCALE = 0x07D0 ($K_{ECSF} = 2000$ (decimal)) to establish a sample rate of 2000 SPS for the inertial sensors and their signal processing. Use the following sequence on the DIN pin to configure UP_SCALE for this scenario: 0xE2D0, then 0xE307.

Output Sync Mode

When Register MSC_CTRL, Bits[3:2] = 11, the ADIS16505 operates in output sync mode, which is the same as internal clock mode except that the SYNC pin pulses when the internal processor collects data from the inertial sensors. Figure 29 provides an example of this signal.

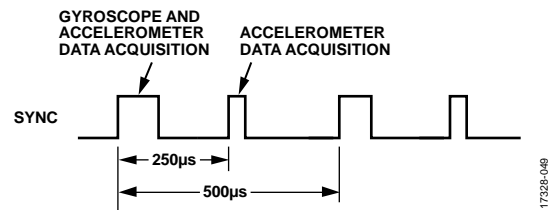

Figure 29. Sync Output Signal, Register MSC_CTRL, Bits[3:2] = 11

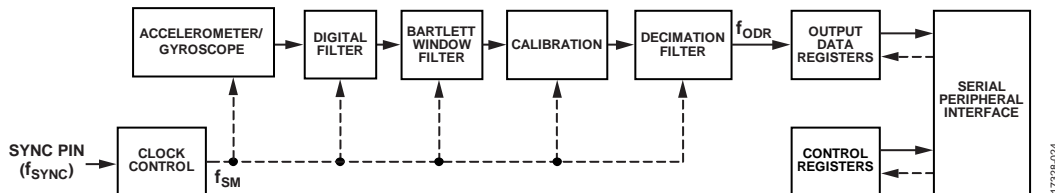

Figure 30. Sensor Signal Chain

BARTLETT WINDOW FILTER

The Bartlett window filter is a finite impulse response (FIR) filter (see Figure 31) that contains two averaging filter stages in a cascade configuration. The FILT_CTRL register (see Table 102) provides the configuration controls for this filter.

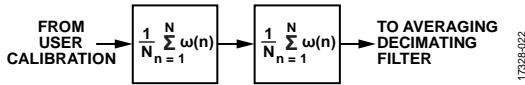

Figure 31. Bartlett Window FIR Filter Signal Path

CALIBRATION

The inertial sensor calibration function for the gyroscopes and the accelerometers has two components: factory calibration and user calibration (see Figure 32).

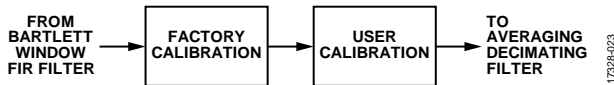

Figure 32. Inertial Sensor Calibration Processing

The factory calibration of the gyroscope applies the following correction formulas to the data of each gyroscope:

$$\begin{bmatrix} \omega_{XC} \\ \omega_{YC} \\ \omega_{ZC} \end{bmatrix} = \begin{bmatrix} m_{11} & m_{12} & m_{13} \\ m_{21} & m_{22} & m_{23} \\ m_{31} & m_{32} & m_{33} \end{bmatrix} \times \begin{bmatrix} \omega_X \\ \omega_Y \\ \omega_Z \end{bmatrix} + \begin{bmatrix} b_X \\ b_Y \\ b_Z \end{bmatrix} + \begin{bmatrix} l_{11} & l_{12} & l_{13} \\ l_{21} & l_{22} & l_{23} \\ l_{31} & l_{32} & l_{33} \end{bmatrix} \times \begin{bmatrix} a_{XC} \\ a_{YC} \\ a_{ZC} \end{bmatrix}$$

where:

ω_{XC} , ω_{YC} , and ω_{ZC} are the gyroscope outputs (post calibration). m_{11} , m_{12} , m_{13} , m_{21} , m_{22} , m_{23} , m_{31} , m_{32} , and m_{33} provide scale and alignment correction.

ω_X , ω_Y , and ω_Z are the gyroscope outputs (precalibration). b_X , b_Y , and b_Z provide bias correction.

l_{11} , l_{12} , l_{13} , l_{21} , l_{22} , l_{23} , l_{31} , l_{32} , and l_{33} provide linear acceleration correction

a_{XC} , a_{YC} , and a_{ZC} are the accelerometer outputs (post calibration).

All of the correction factors in this relationship come from direct observation of the response of each gyroscope at multiple temperatures over the calibration temperature range ($-40^\circ\text{C} \leq T_c \leq +85^\circ\text{C}$). These correction factors are stored in the flash memory bank, but they are not available for observation or configuration.

Register MSC_CTRL, Bit 7 (see Table 106) provides the only user-configurable option for the factory calibration of the gyroscopes: an on/off control for the linear acceleration compensation. See Figure 56 for more details on the user calibration options available for the gyroscopes.

The factory calibration of the accelerometer applies the following correction formulas to the data of each accelerometer:

$$\begin{bmatrix} a_{XC} \\ a_{YC} \\ a_{ZC} \end{bmatrix} = \begin{bmatrix} m_{11} & m_{12} & m_{13} \\ m_{21} & m_{22} & m_{23} \\ m_{31} & m_{32} & m_{33} \end{bmatrix} \times \begin{bmatrix} a_X \\ a_Y \\ a_Z \end{bmatrix} + \begin{bmatrix} b_X \\ b_Y \\ b_Z \end{bmatrix} + \begin{bmatrix} 0 & p_{12} & p_{13} \\ p_{21} & 0 & p_{23} \\ p_{31} & p_{32} & 0 \end{bmatrix} \times \begin{bmatrix} \omega_{XC}^2 \\ \omega_{YC}^2 \\ \omega_{ZC}^2 \end{bmatrix}$$

where:

a_{XC} , a_{YC} , and a_{ZC} are the accelerometer outputs (post calibration). m_{11} , m_{12} , m_{13} , m_{21} , m_{22} , m_{23} , m_{31} , m_{32} , and m_{33} provide scale and alignment correction.

a_X , a_Y , and a_Z are the accelerometer outputs (precalibration). b_X , b_Y , and b_Z provide bias correction.

p_{12} , p_{13} , p_{21} , p_{23} , p_{31} and p_{32} provide a point of percussion alignment correction (see Figure 59).

ω_{XC}^2 , ω_{YC}^2 , and ω_{ZC}^2 are the square of the gyroscope outputs (post calibration).

All of the correction factors in this relationship come from direct observation of the response of each accelerometer at multiple temperatures, over the calibration temperature range ($-40^\circ\text{C} \leq T_c \leq +85^\circ\text{C}$). These correction factors are stored in the flash memory bank but are not available for observation or configuration. MSC_CTRL, Bit 6 (see Table 106) provides the only user configuration option for the factory calibration of the accelerometers: an on/off control for the point of percussion, alignment function. See Figure 57 for more details on the user calibration options available for the accelerometers.

DECIMATION FILTER

The second digital filter averages multiple samples together to produce each register update. The number of samples in the average is equal to the reduction in the update rate (f_{ODR}) for the output data registers (see Figure 33). The DEC_RATE register (see Table 110) provides the configuration controls for this filter.

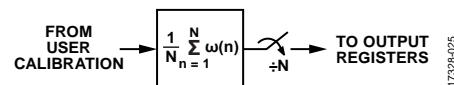

Figure 33. Decimating Filter Diagram

REGISTER STRUCTURE

All communication between the ADIS16505 and an external processor involves either reading the contents of an output register or writing configuration/command information to a control register. The output data registers include the latest sensor data, error flags, and identification information. The control registers include sample rate, filtering, calibration, and diagnostic options. Each user accessible register has two bytes (upper and lower), each of which has its own unique address.

See Table 9 for a detailed list of all user registers, along with their addresses.

SPI

The SPI provides access to the user registers (see Table 9). Figure 34 shows the most common connections between the ADIS16505 and a SPI master device, which is often an embedded processor that has a SPI-compatible interface. In this example, the SPI master uses an interrupt service routine to collect data every time the data ready (DR) signal pulses.

Additional information on the SPI can be found in the Applications Information section.

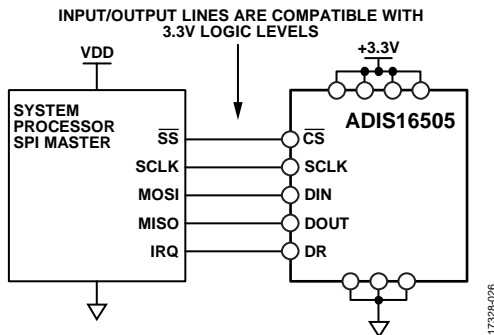

Figure 34. Electrical Connection Diagram

Table 6 provides an example list of pin names for the SPI port in an embedded processor.

Table 6. Generic SPI Master Pin Names and Functions

| Mnemonic | Function |
|----------|----------------------------|
| SS | Slave select |
| SCLK | Serial clock |
| MOSI | Master output, slave input |
| MISO | Master input, slave output |
| IRQ | Interrupt request |

Embedded processors typically configure their serial ports for communicating with SPI slave devices such as the ADIS16505 by using control registers on the processor itself. Table 7 lists the SPI protocol settings for the ADIS16505.

Table 7. Generic Master Processor SPI Settings

| Processor Setting | Description |
|---------------------------|--|
| Master | ADIS16505 operates as slave |
| SCLK ≤ 2 MHz ¹ | Maximum serial clock rate |
| SPI Mode 3 | CPOL = 1 (polarity), CPHA = 1 (phase) |
| MSB First Mode | Bit sequence, see Figure 40 for coding |
| 16-Bit Mode | Shift register and data length |

¹ A burst mode read requires this value to be ≤ 1 MHz (see Table 2 for more information).

DATA READY (DR)

The factory default configuration provides users with a DR signal on the DR pin (see Table 5), which pulses when the output data registers are updating. Connect the DR pin to an input pin on the embedded processor and configure this pin to trigger data collection on the second edge of the pulse on the DR pin. The MSC_CTRL register, Bit 0 (see Table 106), controls the polarity of this signal. In Figure 35 shows a DR signal with Register MSC_CTRL, Bit 0 = 1, meaning that data collection must start on the rising edges of the DR pulses.

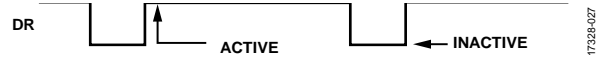

Figure 35. Data Ready When Register MSC_CTRL, Bit 0 = 1 (Default)

During the start-up and reset recovery processes, the DR signal can exhibit some transient behavior before data production begins. Figure 36 shows an example of the DR behavior during startup, and Figure 37 and Figure 38 provide examples of the DR behavior during recovery from reset commands.

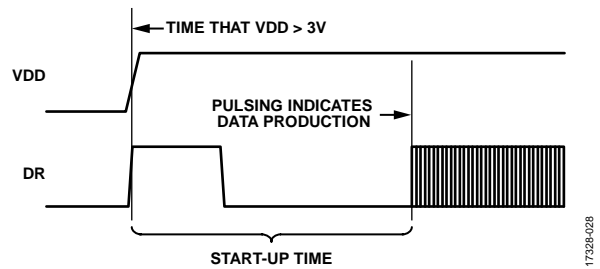

Figure 36. Data Ready Response During Startup

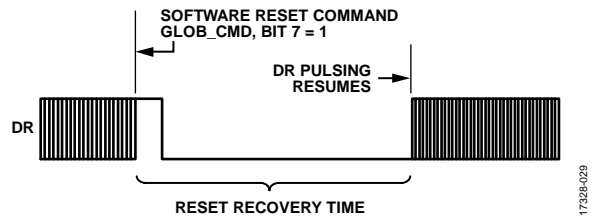

Figure 37. Data Ready Response During Reset Recovery (Register GLOB_CMD, Bit 7 = 1)

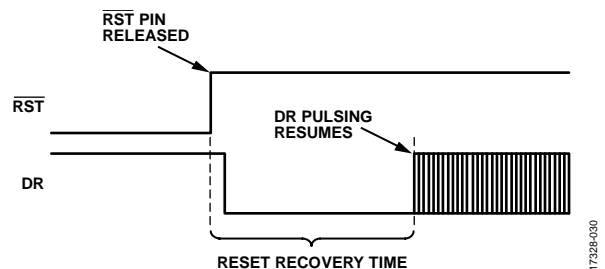

Figure 38. Data Ready Response During Reset (RST = 0) Recovery

READING SENSOR DATA

Reading a single register requires two 16-bit cycles on the SPI: one to request the contents of a register and another to receive those contents. The 16-bit command code (see Figure 40) for a read request on the SPI has three parts: the read bit ($\bar{R}/W = 0$), either address of the register, [A6:A0], and eight don't care bits, [DC7:DC0]. Figure 39 shows an example that includes two register reads in succession. This example starts with DIN = 0x0C00 to request the contents of the Z_GYRO_LOW register, and follows with 0x0E00 to request the contents of the Z_GYRO_OUT register. The sequence in Figure 39 also shows full duplex mode of operation, which means that the ADIS16505 can receive requests

on DIN while also transmitting data out on DOUT within the same 16-bit SPI cycle.

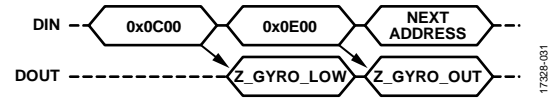

Figure 39. SPI Read Example

Figure 41 provides an example of the four SPI signals when reading the PROD_ID register (see Table 122) in a repeating pattern. This pattern can be helpful when troubleshooting the SPI interface setup and communications because the signals are the same for each 16-bit sequence, except during the first cycle.

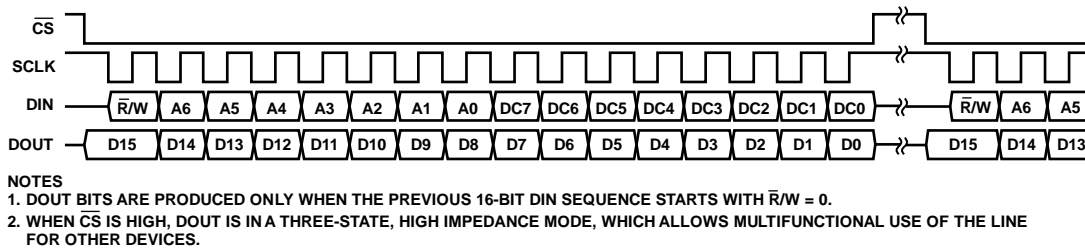

Figure 40. SPI Communication Bit Sequence

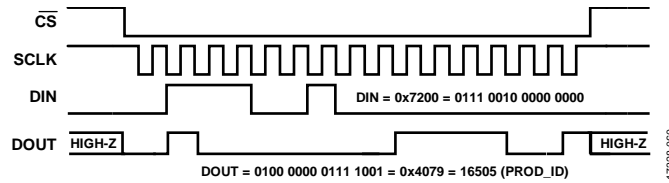

Figure 41. SPI Signal Pattern, Repeating Read of the PROD_ID Register

BURST READ FUNCTION

The burst read function provides a way to read a batch of output data registers, using a continuous stream of bits, at a rate of up to 1 MHz (SCLK). This method does not require a stall time between each 16-bit segment (see Figure 3). As shown in Figure 42, start this mode by setting DIN = 0x6800, and then read each of the registers in the sequence out of DOUT while keeping CS low for the entire data transfer sequence.

The three options for burst mode include: scaled sync mode on or off, BURST32 enabled and disabled, and BURST_SEL = 0 or BURSET_SEL = 1. This results in eight possible burst data formats.

Scaled Sync Mode Enabled vs. Disabled

The only differences in the burst data format between these two modes are the final two bytes in a burst. In scaled sync mode, the final two bytes are the values of the TIME_STAMP registers. When scaled sync mode is disabled, the final two bytes are the values in the DATA_CNTR registers. As always, Bits[15:8] appear before Bits[7:0] in both modes.

For the rest of this section, it is assumed that scaled sync mode is disabled.

16-Bit Burst Mode with BURST_SEL = 0

In 16-bit burst mode with BURST_SEL = 0, a burst contains calibrated gyroscope and accelerometer data in 16-bit format. This mode is particularly appropriate for cases where there is no decimation nor filtering. Not only is the sample rate high (~2 kSPS), the lower 16 bits are not used unless the user is averaging or filtering.

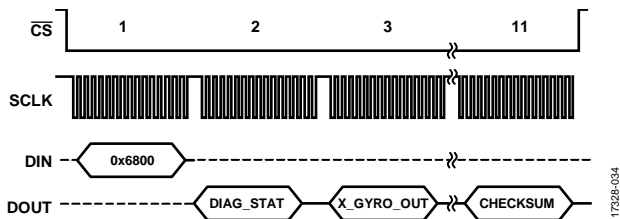

Figure 42. Burst Read Sequence with BURST_SEL = 0

The sequence of registers (and checksum value) in the burst read includes the following registers and value: DIAG_STAT, X_GYRO_OUT, Y_GYRO_OUT, Z_GYRO_OUT, X_ACCL_OUT, Y_ACCL_OUT, Z_ACCL_OUT, TEMP_OUT, DATA_CNTR, and the checksum value.

In these cases, use the following formula to verify the 16-bit checksum value, treating each byte in the formula as an independent, unsigned, 8-bit number:

$$\begin{aligned} \text{Checksum} = & \text{DIAG_STAT, Bits}[15:8] + \text{DIAG_STAT, Bits}[7:0] + \\ & \text{X_GYRO_OUT, Bits}[15:8] + \text{X_GYRO_OUT, Bits}[7:0] + \\ & \text{Y_GYRO_OUT, Bits}[15:8] + \text{Y_GYRO_OUT, Bits}[7:0] + \\ & \text{Z_GYRO_OUT, Bits}[15:8] + \text{Z_GYRO_OUT, Bits}[7:0] + \\ & \text{X_ACCL_OUT, Bits}[15:8] + \text{X_ACCL_OUT, Bits}[7:0] + \\ & \text{Y_ACCL_OUT, Bits}[15:8] + \text{Y_ACCL_OUT, Bits}[7:0] + \\ & \text{Z_ACCL_OUT, Bits}[15:8] + \text{Z_ACCL_OUT, Bits}[7:0] + \\ & \text{TEMP_OUT, Bits}[15:8] + \text{TEMP_OUT, Bits}[7:0] + \\ & \text{DATA_CNTR, Bits}[15:8] + \text{DATA_CNTR, Bits}[7:0] \end{aligned}$$

16-Bit Burst Mode with BURST_SEL = 1

In 16-bit burst mode with BURST_SEL = 1, a burst contains calibrated delta angle and delta velocity data in 16-bit format. This mode is particularly appropriate for cases where there is no decimation nor filtering. Not only is the sample rate high (~2 kSPS), the lower 16 bits are not used.

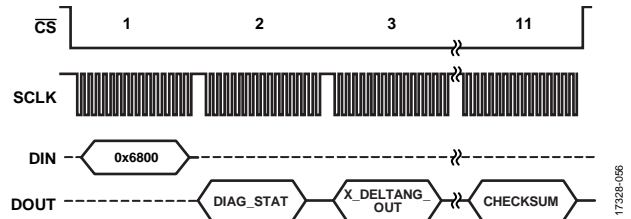

Figure 43. Burst Read Sequence with BURST_SEL = 1

The sequence of registers (and checksum value) in the burst read includes the following registers and value: DIAG_STAT, X_DELTANG_OUT, Y_DELTANG_OUT, Z_DELTANG_OUT, X_DELTVEL_OUT, Y_DELTVEL_OUT, Z_DELTVEL_OUT, TEMP_OUT, DATA_CNTR, and the checksum value.

In these cases, use the following formula to verify the 16-bit checksum value, treating each byte in the formula as an independent, unsigned, 8-bit number:

$$\begin{aligned} \text{Checksum} = & \text{DIAG_STAT, Bits}[15:8] + \text{DIAG_STAT, Bits}[7:0] + \\ & \text{X_DELTANG_OUT, Bits}[15:8] + \text{X_DELTANG_OUT, Bits}[7:0] + \\ & \text{Y_DELTANG_OUT, Bits}[15:8] + \text{Y_DELTANG_OUT, Bits}[7:0] + \\ & \text{Z_DELTANG_OUT, Bits}[15:8] + \text{Z_DELTANG_OUT, Bits}[7:0] + \\ & \text{X_DELTVEL_OUT, Bits}[15:8] + \text{X_DELTVEL_OUT, Bits}[7:0] + \\ & \text{Y_DELTVEL_OUT, Bits}[15:8] + \text{Y_DELTVEL_OUT, Bits}[7:0] + \\ & \text{Z_DELTVEL_OUT, Bits}[15:8] + \text{Z_DELTVEL_OUT, Bits}[7:0] + \\ & \text{TEMP_OUT, Bits}[15:8] + \text{TEMP_OUT, Bits}[7:0] + \\ & \text{DATA_CNTR, Bits}[15:8] + \text{DATA_CNTR, Bits}[7:0] \end{aligned}$$

32-Bit Burst Mode with BURST_SEL = 0

In 32-bit burst mode with BURST_SEL = 0, a burst contains calibrated gyroscope and accelerometer data in 32-bit format. This mode is appropriate for cases where there is averaging (decimation) and/or low-pass filtering of the data.

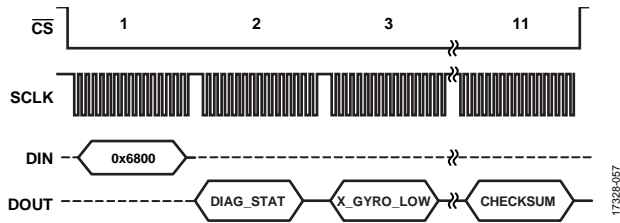

Figure 44. Burst Read Sequence with BURST_SEL = 0

The sequence of registers (and checksum value) in the burst read includes the following registers and value: DIAG_STAT, X_GYRO_LOW, X_GYRO_OUT, Y_GYRO_LOW, Y_GYRO_OUT, Z_GYRO_LOW, Z_GYRO_OUT, X_ACCL_LOW, X_ACCL_OUT, Y_ACCL_LOW, Y_ACCL_OUT, Z_ACCL_LOW, Z_ACCL_OUT, TEMP_OUT, DATA_CNTR, and the checksum value. In these cases, use the following formula to verify the 16-bit checksum value, treating each byte in the formula as an independent, unsigned, 8-bit number:

$$\begin{aligned} \text{Checksum} = & \text{DIAG_STAT, Bits}[15:8] + \text{DIAG_STAT, Bits}[7:0] + \\ & \text{X_GYRO_LOW, Bits}[15:8] + \text{X_GYRO_LOW, Bits}[7:0] + \\ & \text{X_GYRO_OUT, Bits}[15:8] + \text{X_GYRO_OUT, Bits}[7:0] + \\ & \text{Y_GYRO_LOW, Bits}[15:8] + \text{Y_GYRO_LOW, Bits}[7:0] + \\ & \text{Y_GYRO_OUT, Bits}[15:8] + \text{Y_GYRO_OUT, Bits}[7:0] + \\ & \text{Z_GYRO_LOW, Bits}[15:8] + \text{Z_GYRO_LOW, Bits}[7:0] + \\ & \text{Z_GYRO_OUT, Bits}[15:8] + \text{Z_GYRO_OUT, Bits}[7:0] + \\ & \text{X_ACCL_LOW, Bits}[15:8] + \text{X_ACCL_LOW, Bits}[7:0] + \\ & \text{X_ACCL_OUT, Bits}[15:8] + \text{X_ACCL_OUT, Bits}[7:0] + \\ & \text{Y_ACCL_LOW, Bits}[15:8] + \text{Y_ACCL_LOW, Bits}[7:0] + \\ & \text{Y_ACCL_OUT, Bits}[15:8] + \text{Y_ACCL_OUT, Bits}[7:0] + \\ & \text{Z_ACCL_LOW, Bits}[15:8] + \text{Z_ACCL_LOW, Bits}[7:0] + \\ & \text{Z_ACCL_OUT, Bits}[15:8] + \text{Z_ACCL_OUT, Bits}[7:0] + \\ & \text{TEMP_OUT, Bits}[15:8] + \text{TEMP_OUT, Bits}[7:0] + \\ & \text{DATA_CNTR, Bits}[15:8] + \text{DATA_CNTR, Bits}[7:0] \end{aligned}$$

32-Bit Burst Mode with BURST_SEL = 1

In 32-bit burst mode with BURST_SEL = 1, a burst contains calibrated delta angle and delta velocity data in 32-bit format. This mode is appropriate for cases where there is averaging (decimation) and/or low-pass filtering of the data.

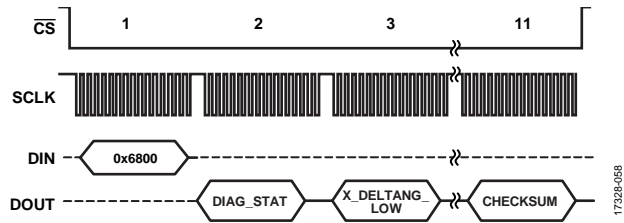

Figure 45. Burst Read Sequence with BURST_SEL = 1

The sequence of registers (and checksum value) in the burst read includes the following registers and value: DIAG_STAT, X_DELTANG_LOW, X_DELTANG_OUT, Y_DELTANG_LOW, Y_DELTANG_OUT, Z_DELTANG_LOW, Z_DELTANG_OUT, X_DELTVEL_LOW, X_DELTVEL_OUT, Y_DELTVEL_LOW, Y_DELTVEL_OUT, Z_DELTVEL_LOW, Z_DELTVEL_OUT, TEMP_OUT, DATA_CNTR, and the checksum value. In these cases, use the following formula to verify the 16-bit checksum value, treating each byte in the formula as an independent, unsigned, 8-bit number:

$$\begin{aligned} \text{Checksum} = & \text{DIAG_STAT, Bits}[15:8] + \text{DIAG_STAT, Bits}[7:0] + \\ & \text{X_DELTANG_LOW, Bits}[15:8] + \text{X_DELTANG_LOW, Bits}[7:0] + \\ & \text{X_DELTANG_OUT, Bits}[15:8] + \text{X_DELTANG_OUT, Bits}[7:0] + \\ & \text{Y_DELTANG_LOW, Bits}[15:8] + \text{Y_DELTANG_LOW, Bits}[7:0] + \\ & \text{Y_DELTANG_OUT, Bits}[15:8] + \text{Y_DELTANG_OUT, Bits}[7:0] + \\ & \text{Z_DELTANG_LOW, Bits}[15:8] + \text{Z_DELTANG_LOW, Bits}[7:0] + \\ & \text{Z_DELTANG_OUT, Bits}[15:8] + \text{Z_DELTANG_OUT, Bits}[7:0] + \\ & \text{X_DELTVEL_LOW, Bits}[15:8] + \text{X_DELTVEL_LOW, Bits}[7:0] + \\ & \text{X_DELTVEL_OUT, Bits}[15:8] + \text{X_DELTVEL_OUT, Bits}[7:0] + \\ & \text{Y_DELTVEL_LOW, Bits}[15:8] + \text{Y_DELTVEL_LOW, Bits}[7:0] + \\ & \text{Y_DELTVEL_OUT, Bits}[15:8] + \text{Y_DELTVEL_OUT, Bits}[7:0] + \\ & \text{Z_DELTVEL_LOW, Bits}[15:8] + \text{Z_DELTVEL_LOW, Bits}[7:0] + \\ & \text{Z_DELTVEL_OUT, Bits}[15:8] + \text{Z_DELTVEL_OUT, Bits}[7:0] + \\ & \text{TEMP_OUT, Bits}[15:8] + \text{TEMP_OUT, Bits}[7:0] + \\ & \text{DATA_CNTR, Bits}[15:8] + \text{DATA_CNTR, Bits}[7:0] \end{aligned}$$

LATENCY

Table 8 contains the group delay for each inertial sensor when the ADIS16505 is operating with the factory default settings for the FILT_CTRL (see Table 101) and DEC_RATE (see Table 109) registers.

Table 8. Group Delay with No Filtering

| Inertial Sensor | Group Delay (ms) ¹ |
|--------------------|-------------------------------|
| Accelerometer | 1.57 |
| Gyroscope (X-Axis) | 1.51 |
| Gyroscope (Y-Axis) | 1.51 |
| Gyroscope (Z-Axis) | 1.29 |

¹ In this context, latency represents the time between the motion (linear acceleration and/or angular rate of rotation) and the time that the representative data is available in the output data register.

When the FILT_CTRL register is not equal to 0, the group delay contribution of the Bartlett window filter (in terms of sample cycles) is equal to N (see Table 102). When the DEC_RATE register is not equal to 0, the group delay contribution of the decimation filter (in terms of sample cycles) is equal D + 1, divided by 2 (see Table 110).

Data Acquisition

The total latency is equal to the sum of the group delay and the data acquisition time, which represents the time it takes the system processor to read the data from the output data registers of the ADIS16505. For example, when using the burst read function, with an SCLK rate of 1 MHz, the data acquisition time is equal to 176 μs (11 segments × 16 SCLKs/segment × 1 μs/SCLK).

DEVICE CONFIGURATION

Each configuration register contains 16 bits (two bytes). Bits[7:0] contain the low byte, and Bits[15:8] contain the high byte. Each byte has its own unique address in the user register map (see Table 9). Updating the contents of a register requires writing to both of its bytes in the following sequence: low byte first, high byte second. There are three parts to coding a SPI command (see Figure 40) that write a new byte of data to a register: the

write bit ($R/W = 1$), the address of the byte, [A6:A0], and the new data for that location, [DC7:DC0]. Figure 46 shows a coding example for writing 0x0004 to the FILT_CTRL register (see Table 102). In Figure 46, the 0xDC04 command writes 0x04 to Address 0x5C (lower byte) and the 0xDD00 command writes 0x00 to Address 0x5D (upper byte).

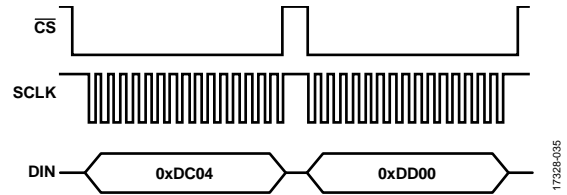

Figure 46. SPI Sequence for Writing 0x0004 to FILT_CTRL

MEMORY STRUCTURE

Figure 47 provides a functional diagram for the memory structure of the ADIS16505. The flash memory bank contains the operational code, unit specific calibration coefficients, and user configuration settings. During initialization (power application or reset recover), this information loads from the flash memory into the static random access memory (SRAM), which supports all normal operation including register access through the SPI port. Writing to a configuration register using the SPI updates the SRAM location of the register but does not automatically update its settings in the flash memory bank. The manual flash memory update command (Register GLOB_CMD, Bit 3, see Table 114) provides a convenient method for saving all of these settings to the flash memory bank at one time. A yes in the flash backup column of Table 9 identifies the registers that have storage support in the flash memory bank.

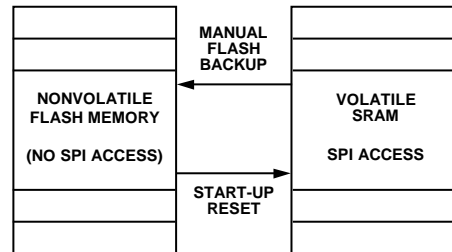

Figure 47. SRAM and Flash Memory Diagram

USER REGISTER MEMORY MAP

Table 9. User Register Memory Map (N/A Means Not Applicable)

| Name | R/W | Flash Backup | Address | Default | Register Description |
|---------------|-----|--------------|--------------|------------------|---|
| Reserved | N/A | N/A | 0x00, 0x01 | N/A | Reserved |
| DIAG_STAT | R | No | 0x02, 0x03 | 0x0000 | Output, system error flags |
| X_GYRO_LOW | R | No | 0x04, 0x05 | N/A | Output, x-axis gyroscope, low word |
| X_GYRO_OUT | R | No | 0x06, 0x07 | N/A | Output, x-axis gyroscope, high word |
| Y_GYRO_LOW | R | No | 0x08, 0x09 | N/A | Output, y-axis gyroscope, low word |
| Y_GYRO_OUT | R | No | 0x0A, 0x0B | N/A | Output, y-axis gyroscope, high word |
| Z_GYRO_LOW | R | No | 0x0C, 0x0D | N/A | Output, z-axis gyroscope, low word |
| Z_GYRO_OUT | R | No | 0x0E, 0x0F | N/A | Output, z-axis gyroscope, high word |
| X_ACCL_LOW | R | No | 0x10, 0x11 | N/A | Output, x-axis accelerometer, low word |
| X_ACCL_OUT | R | No | 0x12, 0x13 | N/A | Output, x-axis accelerometer, high word |
| Y_ACCL_LOW | R | No | 0x14, 0x15 | N/A | Output, y-axis accelerometer, low word |
| Y_ACCL_OUT | R | No | 0x16, 0x17 | N/A | Output, y-axis accelerometer, high word |
| Z_ACCL_LOW | R | No | 0x18, 0x19 | N/A | Output, z-axis accelerometer, low word |
| Z_ACCL_OUT | R | No | 0x1A, 0x1B | N/A | Output, z-axis accelerometer, high word |
| TEMP_OUT | R | No | 0x1C, 0x1D | N/A | Output, temperature |
| TIME_STAMP | R | No | 0x1E, 0x1F | N/A | Output, time stamp |
| Reserved | N/A | N/A | 0x20, 0x21 | N/A | Reserved |
| DATA_CNTR | R | No | 0x22, 0x23 | N/A | New data counter |
| X_DELTANG_LOW | R | No | 0x24, 0x25 | N/A | Output, x-axis delta angle, low word |
| X_DELTANG_OUT | R | No | 0x26, 0x27 | N/A | Output, x-axis delta angle, high word |
| Y_DELTANG_LOW | R | No | 0x28, 0x29 | N/A | Output, y-axis delta angle, low word |
| Y_DELTANG_OUT | R | No | 0x2A, 0x2B | N/A | Output, y-axis delta angle, high word |
| Z_DELTANG_LOW | R | No | 0x2C, 0x2D | N/A | Output, z-axis delta angle, low word |
| Z_DELTANG_OUT | R | No | 0x2E, 0x2F | N/A | Output, z-axis delta angle, high word |
| X_DELTVEL_LOW | R | No | 0x30, 0x31 | N/A | Output, x-axis delta velocity, low word |
| X_DELTVEL_OUT | R | No | 0x32, 0x33 | N/A | Output, x-axis delta velocity, high word |
| Y_DELTVEL_LOW | R | No | 0x34, 0x35 | N/A | Output, y-axis delta velocity, low word |
| Y_DELTVEL_OUT | R | No | 0x36, 0x37 | N/A | Output, y-axis delta velocity, high word |
| Z_DELTVEL_LOW | R | No | 0x38, 0x39 | N/A | Output, z-axis delta velocity, low word |
| Z_DELTVEL_OUT | R | No | 0x3A, 0x3B | N/A | Output, z-axis delta velocity, high word |
| Reserved | N/A | N/A | 0x3C to 0x3F | N/A | Reserved |
| XG_BIAS_LOW | R/W | Yes | 0x40, 0x41 | 0x0000 | Calibration, offset, gyroscope, x-axis, low word |
| XG_BIAS_HIGH | R/W | Yes | 0x42, 0x43 | 0x0000 | Calibration, offset, gyroscope, x-axis, high word |
| YG_BIAS_LOW | R/W | Yes | 0x44, 0x45 | 0x0000 | Calibration, offset, gyroscope, y-axis, low word |
| YG_BIAS_HIGH | R/W | Yes | 0x46, 0x47 | 0x0000 | Calibration, offset, gyroscope, y-axis, high word |
| ZG_BIAS_LOW | R/W | Yes | 0x48, 0x49 | 0x0000 | Calibration, offset, gyroscope, z-axis, low word |
| ZG_BIAS_HIGH | R/W | Yes | 0x4A, 0x4B | 0x0000 | Calibration, offset, gyroscope, z-axis, high word |
| XA_BIAS_LOW | R/W | Yes | 0x4C, 0x4D | 0x0000 | Calibration, offset, accelerometer, x-axis, low word |
| XA_BIAS_HIGH | R/W | Yes | 0x4E, 0x4F | 0x0000 | Calibration, offset, accelerometer, x-axis, high word |
| YA_BIAS_LOW | R/W | Yes | 0x50, 0x51 | 0x0000 | Calibration, offset, accelerometer, y-axis, low word |
| YA_BIAS_HIGH | R/W | Yes | 0x52, 0x53 | 0x0000 | Calibration, offset, accelerometer, y-axis, high word |
| ZA_BIAS_LOW | R/W | Yes | 0x54, 0x55 | 0x0000 | Calibration, offset, accelerometer, z-axis, low word |
| ZA_BIAS_HIGH | R/W | Yes | 0x56, 0x57 | 0x0000 | Calibration, offset, accelerometer, z-axis, high word |
| Reserved | N/A | N/A | 0x58 to 0x5B | N/A | Reserved |
| FILT_CTRL | R/W | Yes | 0x5C, 0x5D | 0x0000 | Control, Bartlett window FIR filter |
| RANG_MDL | R | No | 0x5E, 0x5F | N/A ¹ | Measurement range (model specific) identifier |

| Name | R/W | Flash Backup | Address | Default | Register Description |
|--------------|-----|--------------|--------------|---------|---|
| MSC_CTRL | R/W | Yes | 0x60, 0x61 | 0x00C1 | Control, input/output and other miscellaneous options |
| UP_SCALE | R/W | Yes | 0x62, 0x63 | 0x07D0 | Control, scale factor for input clock, scaled sync mode |
| DEC_RATE | R/W | Yes | 0x64, 0x65 | 0x0000 | Control, decimation filter (output data rate) |
| Reserved | N/A | N/A | 0x66, 0x67 | N/A | Reserved |
| GLOB_CMD | W | No | 0x68, 0x69 | N/A | Control, global commands |
| Reserved | N/A | N/A | 0x6A to 0x6B | N/A | Reserved |
| FIRM_REV | R | No | 0x6C, 0x6D | N/A | Identification, firmware revision |
| FIRM_DM | R | No | 0x6E, 0x6F | N/A | Identification, date code, day and month |
| FIRM_Y | R | No | 0x70, 0x71 | N/A | Identification, date code, year |
| PROD_ID | R | No | 0x72, 0x73 | 0x4079 | Identification, device number (0x4079 = 16,505 decimal) |
| SERIAL_NUM | R | No | 0x74, 0x75 | N/A | Identification, serial number |
| USER_SCR_1 | R/W | Yes | 0x76, 0x77 | N/A | User Scratch Register 1 |
| USER_SCR_2 | R/W | Yes | 0x78, 0x79 | N/A | User Scratch Register 2 |
| USER_SCR_3 | R/W | Yes | 0x7A, 0x7B | N/A | User Scratch Register 3 |
| FLSHCNT_LOW | R | No | 0x7C, 0x7D | N/A | Output, flash memory write cycle counter, lower word |
| FLSHCNT_HIGH | R | No | 0x7E, 0x7E | N/A | Output, flash memory write cycle counter, upper word |

¹ See Table 103 for the model specific default value for this register.

USER REGISTER DEFINITIONS

Status/Error Flag Indicators (DIAG_STAT)

Table 10. DIAG_STAT Register Definition

| Addresses | Default | Access | Flash Backup |
|------------|---------|--------|--------------|
| 0x02, 0x03 | 0x0000 | R | No |

Table 11. DIAG_STAT Bit Assignments

| Bits | Description |
|--------|--|
| [15:8] | Reserved. |
| 7 | Clock error. A 1 indicates that the internal data sampling clock (f_{SM} , see Figure 30) does not synchronize with the external clock, which only applies when using scaled sync mode (Register MSC_CTRL, Bits[3:2] = 10, see Table 106). When this error occurs, adjust the frequency of the clock signal on the SYNC pin to operate within the appropriate range. |
| 6 | Memory failure. A 1 indicates a failure in the flash memory test (Register GLOB_CMD, Bit 4, see Table 114), which involves a comparison between a cyclic redundancy check (CRC) calculation of the present flash memory and a CRC calculation from the same memory locations at the time of initial programming (during the production process). If this error occurs, repeat the same test. If this error persists, replace the ADIS16505 device. |
| 5 | Sensor failure. A 1 indicates failure of at least one sensor, at the conclusion of the self test (Register GLOB_CMD, Bit 2, see Table 114). If this error occurs, repeat the same test. If this error persists, replace the ADIS16505. Motion during the execution of this test can cause a false failure. |
| 4 | Standby mode. A 1 indicates that the voltage across VDD and GND is <2.8 V, which causes data processing to stop. When $VDD \geq 2.8$ V for 250 ms, the ADIS16505 reinitializes itself and starts producing data again. |
| 3 | SPI communication error. A 1 indicates that the total number of SCLK cycles is not equal to an integer multiple of 16. When this error occurs, repeat the previous communication sequence. Persistence in this error can indicate a weakness in the SPI service that the ADIS16505 is receiving from the system it is supporting. |
| 2 | Flash memory update failure. A 1 indicates that the most recent flash memory update (Register GLOB_CMD, Bit 3, see Table 114) failed. If this error occurs, ensure that $VDD \geq 3$ V and repeat the update attempt. If this error persists, replace the ADIS16505. |
| 1 | Data path overrun. A 1 indicates that one of the data paths experienced an overrun condition. If this error occurs, initiate a reset using the RST pin (see Table 5, Pin F3) or Register GLOB_CMD, Bit 7 (see Table 114). |
| 0 | Reserved. |

The DIAG_STAT register (see Table 10 and Table 11) provides error flags for monitoring the integrity and operation of the ADIS16505. Reading this register resets its bits to 0. The error flags in DIAG_STAT are sticky, meaning that when they raise to a 1, they remain there until a read request clears them. If an error condition persists, the flag (bit) automatically returns to an alarm value of 1.

GYROSCOPE DATA

The gyroscopes in the ADIS16505 measure the angular rate of rotation around three orthogonal axes (x, y, and z). Figure 48 shows the orientation of each gyroscope axis along with the direction of rotation that produces a positive response in each of their measurements.

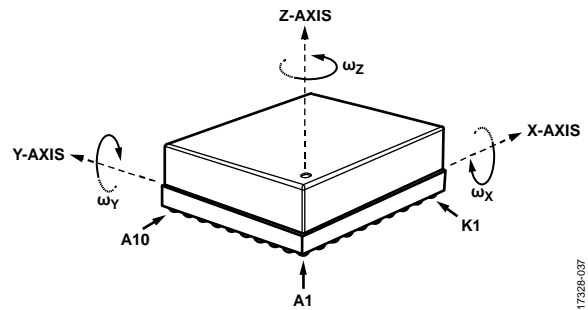

Figure 48. Gyroscope Axis and Polarity Assignments

Each gyroscope has two output data registers. Figure 49 shows how these two registers combine to support a 32-bit, twos complement data format for the x-axis gyroscope measurements. This format also applies to the y- and z-axes.

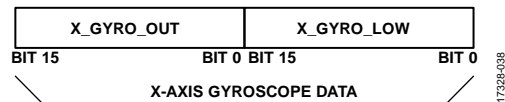

Figure 49. Gyroscope Output Data Structure

Gyroscope Measurement Range/Scale Factor

Table 12 provides the range and scale factor for the angular rate (gyroscope) measurements in each ADIS16505 model.

Table 12. Gyroscope Measurement Range and Scale Factors

| Model | Range, $\pm\omega_{MAX}$ (°/sec) | Scale Factor, K_G (°/sec/LSB) |
|-----------------|----------------------------------|---------------------------------|
| ADIS16505-1BMLZ | ± 125 | 0.00625 |
| ADIS16505-2BMLZ | ± 500 | 0.025 |
| ADIS16505-3BMLZ | ± 2000 | 0.1 |

Gyroscope Data Formatting

Table 13 and Table 14 offer various numerical examples that demonstrate the format of the rotation rate data in both 16-bit and 32-bit formats.

Table 13. 16-Bit Gyroscope Data Format Examples

| Rotation Rate | Decimal | Hex | Binary |
|------------------|---------|--------|---------------------|
| + ω_{MAX} | +20,000 | 0x4E20 | 0100 1110 0010 0000 |
| +2 K_G | +2 | 0x0002 | 0000 0000 0000 0010 |
| + K_G | +1 | 0x0001 | 0000 0000 0000 0001 |
| 0°/sec | 0 | 0x0000 | 0000 0000 0000 0000 |
| - K_G | -1 | 0xFFFF | 1111 1111 1111 1111 |
| -2 K_G | -2 | 0xFFFE | 1111 1111 1111 1110 |
| - ω_{MAX} | -20,000 | 0xB1E0 | 1011 0001 1110 0000 |

Table 14. 32-Bit Gyroscope Data Format Examples

| Rotation Rate (°/sec) | Decimal | Hex |
|-----------------------|----------------|-------------|
| + ω_{MAX} | +1,310,720,000 | 0x4E200000 |
| + $K_G/2^{15}$ | +2 | 0x00000002 |
| + $K_G/2^{16}$ | +1 | 0x00000001 |
| 0 | 0 | 0x00000000 |
| - $K_G/2^{16}$ | -1 | 0xFFFFFFFF |
| - $K_G/2^{15}$ | -2 | 0xFFFFFFFFE |
| - ω_{MAX} | -1,310,720,000 | 0xB1E00000 |

X-Axis Gyroscope (X_GYRO_LOW and X_GYRO_OUT)**Table 15. X_GYRO_LOW Register Definition**

| Addresses | Default | Access | Flash Backup |
|------------|----------------|--------|--------------|
| 0x04, 0x05 | Not applicable | R | No |

Table 16. X_GYRO_LOW Bit Definitions

| Bits | Description |
|--------|---|
| [15:0] | X-axis gyroscope data; additional resolution bits |

Table 17. X_GYRO_OUT Register Definition

| Addresses | Default | Access | Flash Backup |
|------------|----------------|--------|--------------|
| 0x06, 0x07 | Not applicable | R | No |

Table 18. X_GYRO_OUT Bit Definitions

| Bits | Description |
|--------|---|
| [15:0] | X-axis gyroscope data; high word; twos complement, 0°/sec = 0x0000, 1 LSB = K_G (See Table 12 for K_G) |

The X_GYRO_LOW (see Table 15 and Table 16) and X_GYRO_OUT (see Table 17 and Table 18) registers contain the gyroscope data for the x-axis.

Y-Axis Gyroscope (Y_GYRO_LOW and Y_GYRO_OUT)**Table 19. Y_GYRO_LOW Register Definition**

| Addresses | Default | Access | Flash Backup |
|------------|----------------|--------|--------------|
| 0x08, 0x09 | Not applicable | R | No |

Table 20. Y_GYRO_LOW Bit Definitions

| Bits | Description |
|--------|---|
| [15:0] | Y-axis gyroscope data; additional resolution bits |

Table 21. Y_GYRO_OUT Register Definition

| Addresses | Default | Access | Flash Backup |
|------------|----------------|--------|--------------|
| 0x0A, 0x0B | Not applicable | R | No |

Table 22. Y_GYRO_OUT Bit Definitions

| Bits | Description |
|--------|---|
| [15:0] | Y-axis gyroscope data; high word; twos complement, 0°/sec = 0x0000, 1 LSB = K_G (see Table 12 for K_G) |

The Y_GYRO_LOW (see Table 19 and Table 20) and Y_GYRO_OUT (see Table 21 and Table 22) registers contain the gyroscope data for the y-axis.

Z-Axis Gyroscope (Z_GYRO_LOW and Z_GYRO_OUT)**Table 23. Z_GYRO_LOW Register Definition**

| Addresses | Default | Access | Flash Backup |
|------------|----------------|--------|--------------|
| 0x0C, 0x0D | Not applicable | R | No |

Table 24. Z_GYRO_LOW Bit Definitions

| Bits | Description |
|--------|---|
| [15:0] | Z-axis gyroscope data; additional resolution bits |

Table 25. Z_GYRO_OUT Register Definition

| Addresses | Default | Access | Flash Backup |
|------------|----------------|--------|--------------|
| 0x0E, 0x0F | Not applicable | R | No |

Table 26. Z_GYRO_OUT Bit Definitions

| Bits | Description |
|--------|---|
| [15:0] | Z-axis gyroscope data; high word; twos complement, 0°/sec = 0x0000, 1 LSB = K_G (see Table 12 for K_G) |

The Z_GYRO_LOW (see Table 23 and Table 24) and Z_GYRO_OUT (see Table 25 and Table 26) registers contain the gyroscope data for the z-axis.

Acceleration Data

The accelerometers in the ADIS16505 measure both dynamic and static (response to gravity) acceleration along the same three orthogonal axes that define the axes of rotation for the gyroscopes (x, y, and z). Figure 50 shows the orientation of each accelerometer axis along with the direction of acceleration that produces a positive response in each of their measurements.

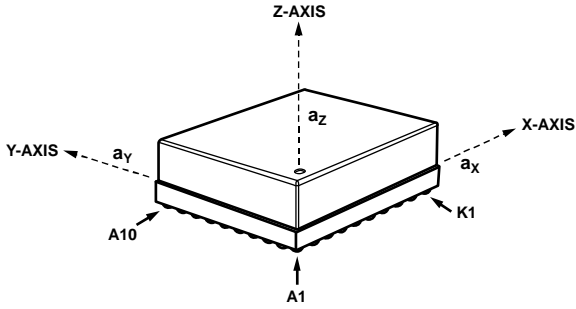

Figure 50. Accelerometer Axis and Polarity Assignments

Each accelerometer has two output data registers. Figure 51 shows how these two registers combine to support a 32-bit, twos complement data format for the x-axis accelerometer measurements. This format also applies to the y- and z-axes.

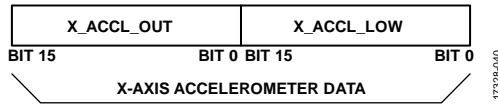

Figure 51. Accelerometer Output Data Structure

Accelerometer Resolution

Table 27 and Table 28 offer various numerical examples that demonstrate the format of the linear acceleration data in both 16-bit and 32-bit formats.

Table 27. 16-Bit Accelerometer Data Format Examples

| Acceleration | Dec | Hex | Binary |
|---|---------|--------|---------------------|
| +78.3 m/sec ² | +32,000 | 0x7D00 | 0111 1101 0000 0000 |
| +4.9/2 ¹⁵ mm/sec ² | +2 | 0x0002 | 0000 0000 0000 0010 |
| +2.45/2 ¹⁶ mm/sec ² | +1 | 0x0001 | 0000 0000 0000 0001 |
| 0 | 0 | 0x0000 | 0000 0000 0000 0000 |
| -2.45/2 ¹⁶ mm/sec ² | -1 | 0xFFFF | 1111 1111 1111 1111 |
| -4.9/2 ¹⁵ mm/sec ² | -2 | 0xFFFE | 1111 1111 1111 1110 |
| -78.3 m/sec ² | -32,000 | 0x8300 | 1000 0011 0000 0000 |

Table 28. 32-Bit Accelerometer Data Format Examples

| Acceleration | Decimal | Hex |
|---|----------------|--------------|
| +78.3 m/sec ² | +2,097,152,000 | 0x7D000000 |
| +4.9/2 ¹⁵ mm/sec ² | +2 | 0x00000002 |
| +2.45/2 ¹⁶ mm/sec ² | +1 | 0x00000001 |
| 0 | 0 | 0x00000000 |
| -2.45/2 ¹⁶ mm/sec ² | -1 | 0xFFFFFFFF |
| -4.9/2 ¹⁵ mm/sec ² | -2 | 0xFFFFFFFFFE |
| -78.3 m/sec ² | -2,097,152,000 | 0x83000000 |

X-Axis Accelerometer (X_ACCL_LOW and X_ACCL_OUT)

Table 29. X_ACCL_LOW Register Definition

| Addresses | Default | Access | Flash Backup |
|------------|----------------|--------|--------------|
| 0x10, 0x11 | Not applicable | R | No |

Table 30. X_ACCL_LOW Bit Definitions

| Bits | Description |
|--------|---|
| [15:0] | X-axis accelerometer data; additional resolution bits |

Table 31. X_ACCL_OUT Register Definition

| Addresses | Default | Access | Flash Backup |
|------------|----------------|--------|--------------|
| 0x12, 0x13 | Not applicable | R | No |

Table 32. X_ACCL_OUT Bit Definitions

| Bits | Description |
|--------|---|
| [15:0] | X-axis accelerometer data, high word; twos complement, $\pm 78.3 \text{ m/sec}^2$ range; $0 \text{ m/sec}^2 = 0x0000$, 1 LSB = 2.45 mm/sec^2 |

The X_ACCL_LOW (see Table 29 and Table 30) and X_ACCL_OUT (see Table 31 and Table 32) registers contain the accelerometer data for the x-axis.

Y-Axis Accelerometer (Y_ACCL_LOW and Y_ACCL_OUT)

Table 33. Y_ACCL_LOW Register Definition

| Addresses | Default | Access | Flash Backup |
|------------|----------------|--------|--------------|
| 0x14, 0x15 | Not applicable | R | No |

Table 34. Y_ACCL_LOW Bit Definitions

| Bits | Description |
|--------|---|
| [15:0] | Y-axis accelerometer data; additional resolution bits |

Table 35. Y_ACCL_OUT Register Definition

| Addresses | Default | Access | Flash Backup |
|------------|----------------|--------|--------------|
| 0x16, 0x17 | Not applicable | R | No |

Table 36. Y_ACCL_OUT Bit Definitions

| Bits | Description |
|--------|---|
| [15:0] | Y-axis accelerometer data, high word; twos complement, $\pm 78.3 \text{ m/sec}^2$ range; $0 \text{ m/sec}^2 = 0x0000$, 1 LSB = 2.45 mm/sec^2 |

The Y_ACCL_LOW (see Table 33 and Table 34) and Y_ACCL_OUT (see Table 35 and Table 36) registers contain the accelerometer data for the y-axis.

Z-Axis Accelerometer (Z_ACCL_LOW and Z_ACCL_OUT)**Table 37. Z_ACCL_LOW Register Definition**

| Addresses | Default | Access | Flash Backup |
|------------|----------------|--------|--------------|
| 0x18, 0x19 | Not applicable | R | No |

Table 38. Z_ACCL_LOW Bit Definitions

| Bits | Description |
|--------|---|
| [15:0] | Z-axis accelerometer data; additional resolution bits |

Table 39. Z_ACCL_OUT Register Definition

| Addresses | Default | Access | Flash Backup |
|------------|----------------|--------|--------------|
| 0x1A, 0x1B | Not applicable | R | No |

Table 40. Z_ACCL_OUT Bit Definitions

| Bits | Description |
|--------|---|
| [15:0] | Z-axis accelerometer data, high word; twos complement, $\pm 78.3 \text{ m/sec}^2$ range; $0 \text{ m/sec}^2 = 0x0000$, 1 LSB = 2.45 mm/sec^2 |

The Z_ACCL_LOW (see Table 37 and Table 38) and Z_ACCL_OUT (see Table 39 and Table 40) registers contain the accelerometer data for the z-axis.

Internal Temperature (TEMP_OUT)**Table 41. TEMP_OUT Register Definition**

| Addresses | Default | Access | Flash Backup |
|------------|----------------|--------|--------------|
| 0x1C, 0x1D | Not applicable | R | No |

Table 42. TEMP_OUT Bit Definitions

| Bits | Description |
|--------|---|
| [15:0] | Temperature data; twos complement, 1 LSB = 0.1°C , $0^\circ\text{C} = 0x0000$ |

The TEMP_OUT register (see Table 41 and Table 42) provides a coarse measurement of the temperature inside of the ADIS16505. This data is most useful for monitoring relative changes in the thermal environment.

Table 43. TEMP_OUT Data Format Examples

| Temperature ($^\circ\text{C}$) | Decimal | Hex | Binary |
|----------------------------------|---------|--------|---------------------|
| +105 | +1050 | 0x041A | 0000 0100 0001 1010 |
| +25 | +250 | 0x00FA | 0000 0000 1111 1010 |
| +0.2 | +2 | 0x0002 | 0000 0000 0000 0010 |
| +0.1 | +1 | 0x0001 | 0000 0000 0000 0001 |
| +0 | 0 | 0x0000 | 0000 0000 0000 0000 |
| +0.1 | -1 | 0xFFFF | 1111 1111 1111 1111 |
| +0.2 | -2 | 0xFFFE | 1111 1111 1111 1110 |
| -40 | -400 | 0xFE70 | 1111 1110 0111 0000 |

Time Stamp (TIME_STAMP)**Table 44. TIME_STAMP Register Definition**

| Addresses | Default | Access | Flash Backup |
|------------|----------------|--------|--------------|
| 0x1E, 0x1F | Not applicable | R | No |

Table 45. TIME_STAMP Bit Definitions

| Bits | Description |
|--------|---|
| [15:0] | Time from the last pulse on the SYNC pin; offset binary format, 1 LSB = $49.02 \mu\text{s}$ |

The TIME_STAMP register (see Table 44 and Table 45) works in conjunction with scaled sync mode (Register MSC_CTRL, Bits[3:2] = 10, see Table 106). The 16-bit number in TIME_STAMP contains the time associated with the last sample in each data update relative to the most recent edge of the clock signal in the SYNC pin. For example, when the value in the UP_SCALE register (see Table 108) represents a scale factor of 20, DEC_RATE = 0, and the external SYNC rate = 100 Hz, the following time stamp sequence results: 0 LSB, 10 LSB, 20 LSB, 30 LSB, 40 LSB, 50 LSB, 61 LSB, 71 LSB, ... , 193 LSB for the 20th sample, which translates to $0 \mu\text{s}$, $490 \mu\text{s}$, ... , $9460 \mu\text{s}$, the time from the first SYNC edge.

Data Update Counter (DATA_CNTR)**Table 46. DATA_CNTR Register Definition**

| Addresses | Default | Access | Flash Backup |
|------------|----------------|--------|--------------|
| 0x22, 0x23 | Not applicable | R | No |

Table 47. DATA_CNTR Bit Definitions

| Bits | Description |
|--------|---|
| [15:0] | Data update counter, offset binary format |

When the ADIS16505 goes through its power-on sequence or when it recovers from a reset command, DATA_CNTR (see Table 46 and Table 47) starts with a value of 0x0000 and increments every time new data loads into the output registers. When the DATA_CNTR value reaches 0xFFFF, the next data update causes it to wrap back around to 0x0000 where it continues to increment every time new data loads into the output registers.

DELTA ANGLES

In addition to the angular rate of rotation (gyroscope) measurements around each axis (x, y, and z), the ADIS16505 also provides delta angle measurements that represent a calculation of angular displacement between each sample update.

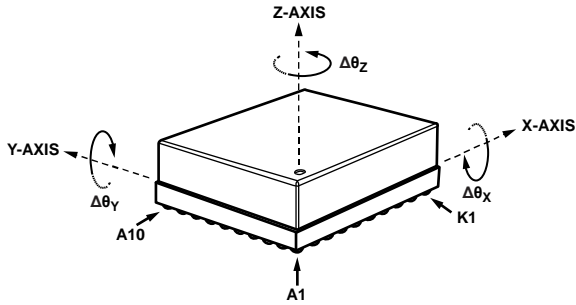

Figure 52. Delta Angle Axis and Polarity Assignments

The delta angle outputs represent an integration of the gyroscope measurements and use the following formula for all three axes (x-axis displayed):

$$\Delta\theta_{x,nD} = \frac{1}{2 \times f_s} \times \sum_{d=0}^{D-1} (\omega_{x,nD+d} + \omega_{x,nD+d-1})$$

where:

D is the decimation rate (DEC_RATE + 1, see Table 110).

f_s is the sample rate.

d is the incremental variable in the summation formula.

ω_x is the x-axis rate of rotation (gyroscope).

n is the sample time, prior to the decimation filter.

When using the internal sample clock, f_s is equal to a nominal rate of 2000 SPS. For better precision in this measurement, measure the internal sample rate (f_s) using the data ready signal on the DR pin (DEC_RATE = 0x0000, see Table 109), divide each delta angle result (from the delta angle output registers) by the data ready frequency, and multiply it by 2000. Each axis of the delta angle measurements has two output data registers. Figure 53 shows how these two registers combine to support a 32-bit, twos complement data format for the x-axis delta angle measurements. This format also applies to the y- and z-axes.

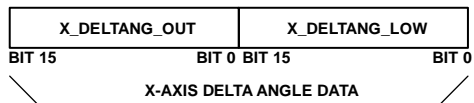

Figure 53. Delta Angle Output Data Structure

Delta Angle Measurement Range

Table 48 shows the measurement range and scale factor for each ADIS16505 model.

Table 48. Delta Angle Measurement Range and Scale Factor

| Model | Measurement Range, $\pm\Delta\theta_{MAX}$ (°) |
|-----------------|--|
| ADIS16505-1BMLZ | ± 360 |
| ADIS16505-2BMLZ | ± 720 |
| ADIS16505-3BMLZ | ± 2160 |

X-Axis Delta Angle (X_DELTANG_LOW and X_DELTANG_OUT)

Table 49. X_DELTANG_LOW Register Definitions

| Addresses | Default | Access | Flash Backup |
|------------|----------------|--------|--------------|
| 0x24, 0x25 | Not applicable | R | No |

Table 50. X_DELTANG_LOW Bit Definitions

| Bits | Description |
|--------|-----------------------------------|
| [15:0] | X-axis delta angle data; low word |

Table 51. X_DELTANG_OUT Register Definitions

| Addresses | Default | Access | Flash Backup |
|------------|----------------|--------|--------------|
| 0x26, 0x27 | Not applicable | R | No |

Table 52. X_DELTANG_OUT Bit Definitions

| Bits | Description |
|--------|--|
| [15:0] | X-axis delta angle data; twos complement, $0^\circ = 0x0000$, 1 LSB = $\Delta\theta_{MAX}/2^{15}$ (see Table 48 for $\pm\Delta\theta_{MAX}$) |

The X_DELTANG_LOW (see Table 49 and Table 50) and X_DELTANG_OUT (see Table 51 and Table 52) registers contain the delta angle data for the x-axis.

Y-Axis Delta Angle (Y_DELTANG_LOW and Y_DELTANG_OUT)

Table 53. Y_DELTANG_LOW Register Definitions

| Addresses | Default | Access | Flash Backup |
|------------|----------------|--------|--------------|
| 0x28, 0x29 | Not applicable | R | No |

Table 54. Y_DELTANG_LOW Bit Definitions

| Bits | Description |
|--------|-----------------------------------|
| [15:0] | Y-axis delta angle data; low word |

Table 55. Y_DELTANG_OUT Register Definitions

| Addresses | Default | Access | Flash Backup |
|------------|----------------|--------|--------------|
| 0x2A, 0x2B | Not applicable | R | No |

Table 56. Y_DELTANG_OUT Bit Definitions

| Bits | Description |
|--------|--|
| [15:0] | Y-axis delta angle data; twos complement, $0^\circ = 0x0000$, 1 LSB = $\Delta\theta_{MAX}/2^{15}$ (see Table 48 for $\pm\Delta\theta_{MAX}$) |

The Y_DELTANG_LOW (see Table 53 and Table 54) and Y_DELTANG_OUT (see Table 55 and Table 56) registers contain the delta angle data for the y-axis.

Z-Axis Delta Angle (Z_DELTANG_LOW and Z_DELTANG_OUT)

Table 57. Z_DELTANG_LOW Register Definitions

| Addresses | Default | Access | Flash Backup |
|------------|----------------|--------|--------------|
| 0x2C, 0x2D | Not applicable | R | No |

Table 58. Z_DELTANG_LOW Bit Definitions

| Bits | Description |
|--------|-----------------------------------|
| [15:0] | Z-axis delta angle data; low word |

Table 59. Z_DELTANG_OUT Register Definitions

| Addresses | Default | Access | Flash Backup |
|------------|----------------|--------|--------------|
| 0x2E, 0x2F | Not applicable | R | No |

Table 60. Z_DELTANG_OUT Bit Definitions

| Bits | Description |
|--------|--|
| [15:0] | Z-axis delta angle data; twos complement, 0° = 0x0000, 1 LSB = $\Delta\theta_{MAX}/2^{15}$ (see Table 48 for $\pm\Delta\theta_{MAX}$) |

The Z_DELTANG_LOW (see Table 57 and Table 58) and Z_DELTANG_OUT (see Table 59 and Table 60) registers contain the delta angle data for the z-axis.

Delta Angle Resolution

Table 61 and Table 62 show various numerical examples that demonstrate the format of the delta angle data in both 16-bit and 32-bit formats.

Table 61. 16-Bit Delta Angle Data Format Examples

| Delta Angle (°) | Decimal | Hex | Binary |
|---|---------|---------|---------------------|
| $\Delta\theta_{MAX} \times (2^{15}-1)/2^{15}$ | +32,767 | 0x7FFF | 0111 1111 1110 1111 |
| $+\Delta\theta_{MAX}/2^{14}$ | +2 | 0x0002 | 0000 0000 0000 0010 |
| $+\Delta\theta_{MAX}/2^{15}$ | +1 | 0x0001 | 0000 0000 0000 0001 |
| 0 | 0 | 0x0000 | 0000 0000 0000 0000 |
| $-\Delta\theta_{MAX}/2^{15}$ | -1 | 0xFFFF | 1111 1111 1111 1111 |
| $-\Delta\theta_{MAX}/2^{14}$ | -2 | 0xFFFFE | 1111 1111 1111 1110 |
| $-\Delta\theta_{MAX}$ | -32,768 | 0x8000 | 1000 0000 0000 0000 |

Table 62. 32-Bit Delta Angle Data Format Examples

| Delta Angle (°) | Decimal | Hex |
|--|----------------|-------------|
| $+\Delta\theta_{MAX} \times (2^{31}-1)/2^{31}$ | +2,147,483,647 | 0x7FFFFFFF |
| $+\Delta\theta_{MAX}/2^{30}$ | +2 | 0x00000002 |
| $+\Delta\theta_{MAX}/2^{31}$ | +1 | 0x00000001 |
| 0 | 0 | 0x00000000 |
| $-\Delta\theta_{MAX}/2^{31}$ | -1 | 0xFFFFFFFF |
| $-\Delta\theta_{MAX}/2^{30}$ | -2 | 0xFFFFFFFFE |
| $-\Delta\theta_{MAX}$ | -2,147,483,648 | 0x80000000 |

DELTA VELOCITY

In addition to the linear acceleration measurements along each axis (x, y, and z), the ADIS16505 also provides delta velocity measurements that represent a calculation of linear velocity change between each sample update.

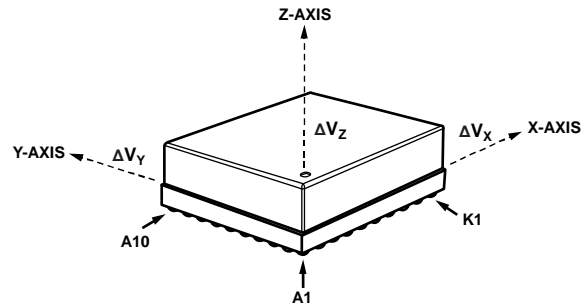

Figure 54. Delta Velocity Axis and Polarity Assignments

The delta velocity outputs represent an integration of the acceleration measurements and use the following formula for all three axes (x-axis displayed):

$$\Delta V_{x,nD} = \frac{1}{2 \times f_s} \times \sum_{d=0}^{D-1} (a_{x,nD+d} + a_{x,nD+d-1})$$

where:

x is the x-axis.

n is the sample time, prior to the decimation filter.

D is the decimation rate (DEC_RATE + 1, see Table 110).

f_s is the sample rate.

d is the incremental variable in the summation formula.

a_x is the x-axis acceleration.

When using the internal sample clock, f_s is equal to a nominal rate of 2000 SPS. For better precision in this measurement, measure the internal sample rate (f_s) using the data ready signal on the DR pin (DEC_RATE = 0x0000, see Table 109), divide each delta angle result (from the delta angle output registers) by the data ready frequency, and multiply it by 2000. Each axis of the delta velocity measurements has two output data registers.

Figure 55 shows how these two registers combine to support 32-bit, twos complement data format for the delta velocity measurements along the x-axis. This format also applies to the y- and z-axes.

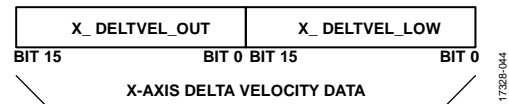

Figure 55. Delta Velocity Output Data Structure

X-Axis Delta Velocity (X_DELTVEL_LOW and X_DELTVEL_OUT)

Table 63. X_DELTVEL_LOW Register Definition

| Addresses | Default | Access | Flash Backup |
|------------|----------------|--------|--------------|
| 0x30, 0x31 | Not applicable | R | No |

Table 64. X_DELTVEL_LOW Bit Definitions

| Bits | Description |
|--------|--|
| [15:0] | X-axis delta velocity data; additional resolution bits |

Table 65. X_DELTVEL_OUT Register Definition

| Addresses | Default | Access | Flash Backup |
|------------|----------------|--------|--------------|
| 0x32, 0x33 | Not applicable | R | No |

Table 66. X_DELTVEL_OUT Bit Definitions

| Bits | Description |
|--------|---|
| [15:0] | X-axis delta velocity data; twos complement, ± 100 m/sec range, 0 m/sec = 0x0000; 1 LSB = $+100 \text{ m/sec} \div 2^{15} = \sim +0.003052 \text{ m/sec}$ |

The X_DELTVEL_LOW (see Table 63 and Table 64) and X_DELTVEL_OUT (see Table 65 and Table 66) registers contain the delta velocity data for the x-axis.

Y-Axis Delta Velocity (Y_DELTVEL_LOW and Y_DELTVEL_OUT)

Table 67. Y_DELTVEL_LOW Register Definition

| Addresses | Default | Access | Flash Backup |
|------------|----------------|--------|--------------|
| 0x34, 0x35 | Not applicable | R | No |

Table 68. Y_DELTVEL_LOW Bit Definitions

| Bits | Description |
|--------|--|
| [15:0] | Y-axis delta velocity data; additional resolution bits |

Table 69. Y_DELTVEL_OUT Register Definition

| Addresses | Default | Access | Flash Backup |
|------------|----------------|--------|--------------|
| 0x36, 0x37 | Not applicable | R | No |

Table 70. Y_DELTVEL_OUT Bit Definitions

| Bits | Description |
|--------|---|
| [15:0] | Y-axis delta velocity data; twos complement, ± 100 m/sec range, 0 m/sec = 0x0000; 1 LSB = $+100 \text{ m/sec} \div 2^{15} = \sim +0.003052 \text{ m/sec}$ |

The Y_DELTVEL_LOW (see Table 67 and Table 68) and Y_DELTVEL_OUT (see Table 69 and Table 70) registers contain the delta velocity data for the y-axis.

Z-Axis Delta Velocity (Z_DELTVEL_LOW and Z_DELTVEL_OUT)

Table 71. Z_DELTVEL_LOW Register Definition

| Addresses | Default | Access | Flash Backup |
|------------|----------------|--------|--------------|
| 0x38, 0x39 | Not applicable | R | No |

Table 72. Z_DELTVEL_LOW Bit Definitions

| Bits | Description |
|--------|--|
| [15:0] | Z-axis delta velocity data; additional resolution bits |

Table 73. Z_DELTVEL_OUT Register Definition

| Addresses | Default | Access | Flash Backup |
|------------|----------------|--------|--------------|
| 0x3A, 0x3B | Not applicable | R | No |

Table 74. Z_DELTVEL_OUT Bit Definitions

| Bits | Description |
|--------|---|
| [15:0] | Z-axis delta velocity data; twos complement, ± 100 m/sec range, 0 m/sec = 0x0000; 1 LSB = $+100 \text{ m/sec} \div 2^{15} = \sim +0.003052 \text{ m/sec}$ |

The Z_DELTVEL_LOW (see Table 71 and Table 72) and Z_DELTVEL_OUT (see Table 73 and Table 74) registers contain the delta velocity data for the z-axis.

Delta Velocity Resolution

Table 75 and Table 76 offer various numerical examples that demonstrate the format of the delta velocity data in both 16-bit and 32-bit formats.

Table 75. 16-Bit Delta Velocity Data Format Examples

| Velocity (m/sec) | Decimal | Hex | Binary |
|-----------------------------------|---------|--------|---------------------|
| $+100 \times (2^{15} - 1)/2^{15}$ | +32,767 | 0x7FFF | 0111 1111 1111 1111 |
| $+100/2^{14}$ | +2 | 0x0002 | 0000 0000 0000 0010 |
| $+100/2^{15}$ | +1 | 0x0001 | 0000 0000 0000 0001 |
| 0 | 0 | 0x0000 | 0000 0000 0000 0000 |
| $-100/2^{15}$ | -1 | 0xFFFF | 1111 1111 1111 1111 |
| $-100/2^{14}$ | -2 | 0xFFFE | 1111 1111 1111 1110 |
| -100 | -32,768 | 0x8000 | 1000 0000 0000 0000 |

Table 76. 32-Bit Delta Velocity Data Format Examples

| Velocity (m/sec) | Decimal | Hex |
|-----------------------------------|----------------|--------------|
| $+100 \times (2^{31} - 1)/2^{31}$ | +2,147,483,647 | 0x7FFFFFFF |
| $+100/2^{30}$ | +2 | 0x00000002 |
| $+100/2^{31}$ | +1 | 0x00000001 |
| 0 | 0 | 0x00000000 |
| $-100/2^{31}$ | -1 | 0xFFFFFFFF |
| $-100/2^{30}$ | -2 | 0xFFFFFFFFFE |
| -100 | +2,147,483,648 | 0x80000000 |

CALIBRATION

The signal chain of each inertial sensor (accelerometers and gyroscopes) includes the application of unique correction formulas, which are derived from extensive characterization of bias, sensitivity, alignment, response to linear acceleration (gyroscopes), and point of percussion (accelerometer location) over a temperature range of -40°C to +85°C, for each ADIS16505. These correction formulas are not accessible, but users do have the opportunity to adjust the bias for each sensor individually through user accessible registers. These correction factors follow immediately after the factory derived correction formulas in the signal chain, which processes at a rate of 2000 Hz when using the internal sample clock.

Calibration, Gyroscope Bias (XG_BIAS_LOW and XG_BIAS_HIGH)

Table 77. XG_BIAS_LOW Register Definition

| Addresses | Default | Access | Flash Backup |
|------------|---------|--------|--------------|
| 0x40, 0x41 | 0x0000 | R/W | Yes |

Table 78. XG_BIAS_LOW Bit Definitions

| Bits | Description |
|--------|--|
| [15:0] | X-axis gyroscope offset correction; lower word |

Table 79. XG_BIAS_HIGH Register Definition

| Addresses | Default | Access | Flash Backup |
|------------|---------|--------|--------------|
| 0x42, 0x43 | 0x0000 | R/W | Yes |

Table 80. XG_BIAS_HIGH Bit Definitions

| Bits | Description |
|--------|---|
| [15:0] | X-axis gyroscope offset correction factor, upper word |

The XG_BIAS_LOW (see Table 77 and Table 78) and XG_BIAS_HIGH (see Table 79 and Table 80) registers combine to allow users to adjust the bias of the x-axis gyroscopes. The data format examples in Table 13 also apply to the XG_BIAS_HIGH register, and the data format examples in Table 14 apply to the 32-bit combination of the XG_BIAS_LOW and XG_BIAS_HIGH registers. See Figure 56 for an illustration of how these two registers combine and influence the x-axis gyroscope measurements.

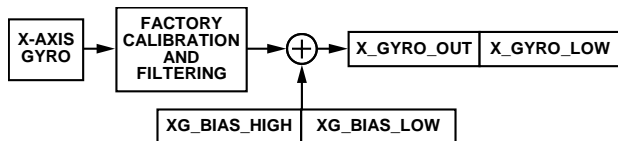

Figure 56. User Calibration Signal Path, Gyroscopes

17328-045

Calibration, Gyroscope Bias (YG_BIAS_LOW and YG_BIAS_HIGH)

Table 81. YG_BIAS_LOW Register Definition

| Addresses | Default | Access | Flash Backup |
|------------|---------|--------|--------------|
| 0x44, 0x45 | 0x0000 | R/W | Yes |

Table 82. YG_BIAS_LOW Bit Definitions

| Bits | Description |
|--------|--|
| [15:0] | Y-axis gyroscope offset correction; lower word |

Table 83. YG_BIAS_HIGH Register Definition

| Addresses | Default | Access | Flash Backup |
|------------|---------|--------|--------------|
| 0x46, 0x47 | 0x0000 | R/W | Yes |

Table 84. YG_BIAS_HIGH Bit Definitions

| Bits | Description |
|--------|---|
| [15:0] | Y-axis gyroscope offset correction factor, upper word |

The YG_BIAS_LOW (see Table 81 and Table 82) and YG_BIAS_HIGH (see Table 83 and Table 84) registers combine to allow users to adjust the bias of the y-axis gyroscopes. The data format examples in Table 13 also apply to the YG_BIAS_HIGH register, and the data format examples in Table 14 apply to the 32-bit combination of the YG_BIAS_LOW and YG_BIAS_HIGH registers. These registers influence the y-axis gyroscope measurements in the same manner that the XG_BIAS_LOW and XG_BIAS_HIGH registers influence the x-axis gyroscope measurements (see Figure 56).

Calibration, Gyroscope Bias (ZG_BIAS_LOW and ZG_BIAS_HIGH)

Table 85. ZG_BIAS_LOW Register Definition

| Addresses | Default | Access | Flash Backup |
|------------|---------|--------|--------------|
| 0x48, 0x49 | 0x0000 | R/W | Yes |

Table 86. ZG_BIAS_LOW Bit Definitions

| Bits | Description |
|--------|--|
| [15:0] | Z-axis gyroscope offset correction; lower word |

Table 87. ZG_BIAS_HIGH Register Definition

| Addresses | Default | Access | Flash Backup |
|------------|---------|--------|--------------|
| 0x4A, 0x4B | 0x0000 | R/W | Yes |

Table 88. ZG_BIAS_HIGH Bit Definitions

| Bits | Description |
|--------|---|
| [15:0] | Z-axis gyroscope offset correction factor, upper word |

The ZG_BIAS_LOW (see Table 85 and Table 86) and ZG_BIAS_HIGH (see Table 87 and Table 88) registers combine to allow users to adjust the bias of the z-axis gyroscopes. The data format examples in Table 13 also apply to the ZG_BIAS_HIGH register, and the data format examples in Table 14 apply to the 32-bit combination of the ZG_BIAS_LOW and ZG_BIAS_HIGH registers.

These registers influence the z-axis gyroscope measurements in the same manner that the XG_BIAS_LOW and XG_BIAS_HIGH registers influence the x-axis gyroscope measurements (see Figure 56).

Calibration, Accelerometer Bias (XA_BIAS_LOW and XA_BIAS_HIGH)

Table 89. XA_BIAS_LOW Register Definition

| Addresses | Default | Access | Flash Backup |
|------------|---------|--------|--------------|
| 0x4C, 0x4D | 0x0000 | R/W | Yes |

Table 90. XA_BIAS_LOW Bit Definitions

| Bits | Description |
|--------|--|
| [15:0] | X-axis accelerometer offset correction; lower word |

Table 91. XA_BIAS_HIGH Register Definition

| Addresses | Default | Access | Flash Backup |
|------------|---------|--------|--------------|
| 0x4E, 0x4F | 0x0000 | R/W | Yes |

Table 92. XA_BIAS_HIGH Bit Definitions

| Bits | Description |
|--------|--|
| [15:0] | X-axis accelerometer offset correction, upper word |

The XA_BIAS_LOW (see Table 89 and Table 90) and XA_BIAS_HIGH (see Table 91 and Table 92) registers combine to allow users to adjust the bias of the x-axis accelerometers. The data format examples in Table 27 also apply to the XA_BIAS_HIGH register and the data format examples in Table 28 apply to the 32-bit combination of the XA_BIAS_LOW and XA_BIAS_HIGH registers. See Figure 57 for an illustration of how these two registers combine and influence the x-axis accelerometer measurements.

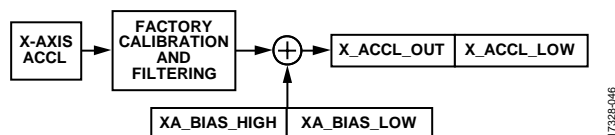

Figure 57. User Calibration Signal Path, Accelerometers

Calibration, Accelerometer Bias (YA_BIAS_LOW and YA_BIAS_HIGH)

Table 93. YA_BIAS_LOW Register Definition

| Addresses | Default | Access | Flash Backup |
|------------|---------|--------|--------------|
| 0x50, 0x51 | 0x0000 | R/W | Yes |

Table 94. YA_BIAS_LOW Bit Definitions

| Bits | Description |
|--------|--|
| [15:0] | Y-axis accelerometer offset correction; lower word |

Table 95. YA_BIAS_HIGH Register Definition

| Addresses | Default | Access | Flash Backup |
|------------|---------|--------|--------------|
| 0x52, 0x53 | 0x0000 | R/W | Yes |

Table 96. YA_BIAS_HIGH Bit Definitions

| Bits | Description |
|--------|--|
| [15:0] | Y-axis accelerometer offset correction, upper word |

The YA_BIAS_LOW (see Table 93 and Table 94) and YA_BIAS_HIGH (see Table 95 and Table 96) registers combine to allow users to adjust the bias of the y-axis accelerometers. The data format examples in Table 27 also apply to the YA_BIAS_HIGH register, and the data format examples in Table 28 apply to the 32-bit combination of the YA_BIAS_LOW and YA_BIAS_HIGH registers. These registers influence the y-axis accelerometer measurements in the same manner that the XA_BIAS_LOW and XA_BIAS_HIGH registers influence the x-axis accelerometer measurements (see Figure 57).

Calibration, Accelerometer Bias (ZA_BIAS_LOW and ZA_BIAS_HIGH)

Table 97. ZA_BIAS_LOW Register Definition

| Addresses | Default | Access | Flash Backup |
|------------|---------|--------|--------------|
| 0x54, 0x55 | 0x0000 | R/W | Yes |

Table 98. ZA_BIAS_LOW Bit Definitions

| Bits | Description |
|--------|--|
| [15:0] | Z-axis accelerometer offset correction; lower word |

Table 99. ZA_BIAS_HIGH Register Definition

| Addresses | Default | Access | Flash Backup |
|------------|---------|--------|--------------|
| 0x56, 0x57 | 0x0000 | R/W | Yes |

Table 100. ZA_BIAS_HIGH Bit Definitions

| Bits | Description |
|--------|--|
| [15:0] | Z-axis accelerometer offset correction, upper word |

The ZA_BIAS_LOW (see Table 97 and Table 98) and ZA_BIAS_HIGH (see Table 99 and Table 100) registers combine to allow users to adjust the bias of the z-axis accelerometers. The data format examples in Table 27 also apply to the ZA_BIAS_HIGH register and the data format examples in Table 28 apply to the 32-bit combination of the ZA_BIAS_LOW and ZA_BIAS_HIGH registers. These registers influence the z-axis accelerometer measurements in the same manner that the XA_BIAS_LOW and XA_BIAS_HIGH registers influence the x-axis accelerometer measurements (see Figure 57).

Filter Control Register (FILT_CTRL)

Table 101. FILT_CTRL Register Definition

| Addresses | Default | Access | Flash Backup |
|------------|---------|--------|--------------|
| 0x5C, 0x5D | 0x0000 | R/W | Yes |

Table 102. FILT_CTRL Bit Definitions

| Bits | Description |
|--------|---|
| [15:3] | Not used |
| [2:0] | Filter Size Variable B; number of taps in each stage; $N = 2^B$ |

The FILT_CTRL register (see Table 101 and Table 102) provides user controls for the Bartlett window FIR filter (see Figure 31), which contains two cascaded averaging filters. For example, use the following sequence to set Register FILT_CTRL, Bits[2:0] = 0100, which sets each stage to have 16 taps: 0xCC04 and 0xCD00. Figure 58 provides the frequency response for several settings in the FILT_CTRL register.

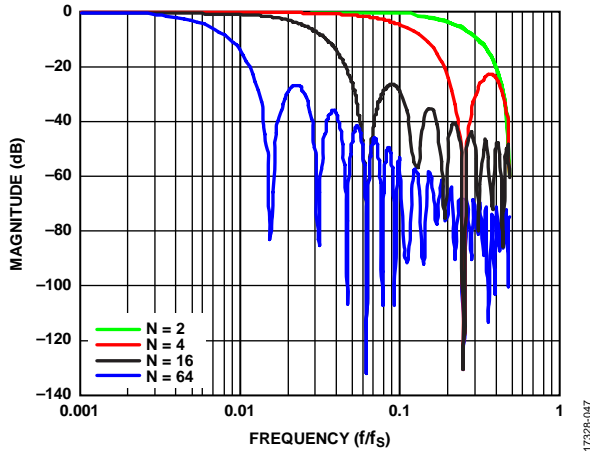

Figure 58. Bartlett Window, FIR Filter Frequency Response (Phase Delay = N Samples)

Range Identifier (RANG_MDL)

Table 103. RANG_MDL Register Definition

| Addresses | Default | Access | Flash Backup |
|------------|----------------|--------|--------------|
| 0x5E, 0x5F | Not applicable | R | No |

Table 104. RANG_MDL Bit Definitions

| Bits | Description |
|--------|--|
| [15:3] | Not used |
| [3:2] | Gyroscope measurement range 00 = $\pm 125^\circ/\text{sec}$ (ADIS16505-1BMLZ) 01 = $\pm 500^\circ/\text{sec}$ (ADIS16505-2BMLZ) 10 = reserved 11 = $\pm 2000^\circ/\text{sec}$ (ADIS16505-3BMLZ) |
| [1:0] | Reserved, binary value = 11 |

Miscellaneous Control Register (MSC_CTRL)

Table 105. MSC_CTRL Register Definition

| Addresses | Default | Access | Flash Backup |
|------------|---------|--------|--------------|
| 0x60, 0x61 | 0x00C1 | R/W | Yes |

Table 106. MSC_CTRL Bit Definitions

| Bits | Description |
|---------|---|
| [15:10] | Not used |
| 9 | BURST32. 32-bit burst enable bit. The user must wait until a full data ready cycle until the burst array updates with the desired data type. 1 = 32-bit burst data. 0 = 16-bit burst data (default). |
| 8 | BURST_SEL. Burst read output array selection. This bit controls what calibrated data is in a burst read. 1 = burst data has delta angle and delta velocity data. 0 = burst data has gyroscope and accelerometer data (default). |
| 7 | Linear acceleration compensation for gyroscopes. When enabled, factory calibrated linear acceleration compensation data is applied to the gyroscope outputs. 1 = enabled. 0 = disabled (default). |
| 6 | Point of percussion alignment. When set, this bit allows for relocation of the acceleration sensors to a common point of percussion on the package corner by considering angular rotations. 1 = enabled. 0 = disabled (default). |
| 5 | Not used. Always set to 0. |
| 4 | SENS_BW. Internal sensor bandwidth. 0 = wide bandwidth (default), see Table 1. 1 = 370 Hz. The gyroscope group delay increases by 0.17 ms and the accelerometer group delay increases by 0.63 ms in this mode. |
| [3:2] | SYNC mode select (see the Clock Control section for more information). 00 = internal SYNC (default). Internal 2 kHz clock used. 01 = direct input sync mode. The user provides an external input clock between 1900 Hz and 2100 Hz. 10 = scaled sync mode. The user provides an external input clock between 1 Hz and 128 Hz, which upscales to 1900 Hz to 2100 Hz inside the ADIS16505. 11 = output sync mode. Identical to internal sync mode, except the SYNC pin functions as an output signal, indicating when the internal clock samples sensors. |
| 1 | SYNC polarity (input or output). 1 = rising edge triggers sampling. 0 = falling edge triggers sampling (default). |
| 0 | DR polarity. This bit controls the polarity of the DR pin. 1 = active high when data is valid. 0 = active low when data is valid (default). |

Point of Percussion

Register MSC_CTRL, Bit 6 (see Table 106) offers an on/off control for the point of percussion alignment function, which maps the accelerometer sensors to the corner of the package that is closest to Pin A1 (see Figure 59). The factory default setting in the MSC_CTRL register activates this function. To turn this function off while retaining the rest of the factory default settings in the MSC_CTRL register, set Register MSC_CTRL, Bit 6 = 0 using the following command sequence on the DIN pin: 0xE081, then 0xE100.

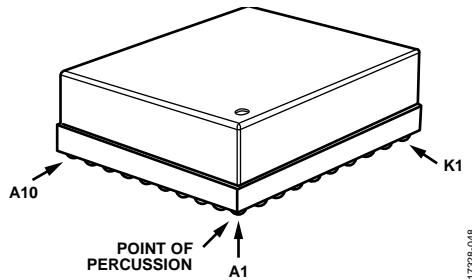

Figure 59. Point of Percussion Reference Point

Linear Acceleration Effect on Gyroscope Bias

Register MSC_CTRL, Bit 7 (see Table 106) provides an on/off control for the linear acceleration compensation in the signal calibration routines of the gyroscope. The factory default contents in the MSC_CTRL register enable this compensation. To turn the compensation off, set Register MSC_CTRL, Bit 7 = 0 using the following sequence on the DIN pin: 0xE041, 0xEF00.

Sync Mode Select

Refer to the Clock Control section for the functions of the sync mode select bits.

Sync Input Frequency Multiplier (UP_SCALE)

Table 107. UP_SCALE Register Definition

| Addresses | Default | Access | Flash Backup |
|------------|---------|--------|--------------|
| 0x62, 0x63 | 0x07D0 | R/W | Yes |

Table 108. UP_SCALE Bit Definitions

| Bits | Description |
|--------|-----------------------------------|
| [15:0] | K _{ECSF} ; binary format |

Refer to the Clock Control section for the function and programming of the UP_SCALE register.

Decimation Filter (DEC_RATE)

Table 109. DEC_RATE Register Definition

| Addresses | Default | Access | Flash Backup |
|------------|---------|--------|--------------|
| 0x64, 0x65 | 0x0000 | R/W | Yes |

Table 110. DEC_RATE Bit Definitions

| Bits | Description |
|---------|--|
| [15:11] | Don't care |
| [10:0] | Decimation rate, binary format, maximum = 1999 |

The DEC_RATE register (see Table 109 and Table 110) provides user control for the averaging decimating filter, which averages and decimates the gyroscope and accelerometer data; it also extends the time that the delta angle and the delta velocity track between each update. When the ADIS16505 operates in internal clock mode (see Register MSC_CTRL, Bits[3:2], in Table 106), the nominal output data rate is equal to 2000/(DEC_RATE + 1). For example, set DEC_RATE = 0x0013 to reduce the output sample rate to 100 SPS (2000 ÷ 20) using the following DIN pin sequence: 0xE413, then 0xE500.

Data Update Rate in External Sync Modes

When using the input sync option in scaled sync mode (Register MSC_CTRL, Bits[3:2] = 10, see Table 106), the output data rate is equal to

$$(f_{\text{SYNC}} \times K_{\text{ECSF}}) / (\text{DEC_RATE} + 1)$$

where:

f_{SYNC} is the frequency of the clock signal on the SYNC pin.

K_{ECSF} is the value from the UP_SCALE register (see Table 108).

When using direct sync mode, K_{ECSF} = 1.

Continuous Bias Estimation (NULL_CNFG)

Table 111. NULL_CNFG Register Definition

| Addresses | Default | Access | Flash Backup |
|------------|---------|--------|--------------|
| 0x66, 0x67 | 0x070A | R/W | Yes |

Table 112. NULL_CNFG Bit Definitions

| Bits | Description |
|---------|---|
| [15:14] | Not used |
| 13 | Z-axis accelerometer bias correction enable (1 = enabled) |
| 12 | Y-axis accelerometer bias correction enable (1 = enabled) |
| 11 | X-axis accelerometer bias correction enable (1 = enabled) |
| 10 | Z-axis gyroscope bias correction enable (1 = enabled) |
| 9 | Y-axis gyroscope bias correction enable (1 = enabled) |
| 8 | X-axis gyroscope bias correction enable (1 = enabled) |
| [7:4] | Not used |
| [3:0] | Time base control (TBC), range: 0 to 12 (default = 10); t _B = 2 ^{TBC} /2000, time base; t _A = 64 × t _B , average time |

The NULL_CNFG register (see Table 111 and Table 112) provides the configuration controls for the continuous bias estimator (CBE) which associates with the bias correction update command in Register GLOB_CMD, Bit 0 (see Table 114).

Register NULL_CNFG, Bits[3:0] establish the total average time (t_A) for the bias estimates and Register NULL_CNFG, Bits[13:8] provide the on/off controls for each sensor. The factory default configuration for the NULL_CNFG register enables the bias null command for the gyroscopes, disables the bias null command for the accelerometers, and sets the average time to ~32 sec.

Global Commands (GLOB_CMD)

Table 113. GLOB_CMD Register Definition

| Addresses | Default | Access | Flash Backup |
|------------|----------------|--------|--------------|
| 0x68, 0x69 | Not applicable | W | No |

Table 114. GLOB_CMD Bit Definitions

| Bits | Description |
|--------|-----------------------------|
| [15:8] | Not used |
| 7 | Software reset |
| [6:5] | Not used |
| 4 | Flash memory test |
| 3 | Flash memory update |
| 2 | Sensor self test |
| 1 | Factory calibration restore |
| 0 | Bias correction update |

The GLOB_CMD register (see Table 113 and Table 114) provides trigger bits for several operations. Write a 1 to the appropriate bit in GLOB_CMD to start a particular function. During the execution of these commands, data production stops, pulsing stops on the DR pin, and the SPI interface does not respond to requests. Table 1 provides the execution time for each GLOB_CMD command.

Software Reset

Use the following DIN sequence to set Register GLOB_CMD, Bit 7 = 1, which triggers a reset: 0xE880, then 0xE900. This reset clears all data, and then restarts data sampling and processing. This function provides a firmware alternative to toggling the RST pin (see Table 5, Pin F3).

Flash Memory Test

Use the following DIN sequence to set Register GLOB_CMD, Bit 4 = 1, which tests the flash memory: 0xE810, then 0xE900. The command performs a CRC computation on the flash memory (excluding user register locations) and compares it to the original CRC value, which comes from the factory configuration process. If the current CRC value does not match the original CRC value, Register DIAG_STAT, Bit 6 (see Table 11), rises to 1, indicating a failing result.

Flash Memory Update

Use the following DIN sequence to set Register GLOB_CMD, Bit 3 = 1, which triggers a backup of all user configurable registers in the flash memory: 0xE808, then 0xE900. Register DIAG_STAT, Bit 2 (see Table 11), identifies success (0) or failure (1) in completing this process.

Sensor Self Test

Use the following DIN sequence to set Register GLOB_CMD, Bit 2 = 1, which triggers the self test routine for the inertial sensors: 0xE804, then 0xE900. The self test routine uses the following steps to validate the integrity of each inertial sensor:

1. Measure the output on each sensor.
2. Activate an internal stimulus on the mechanical elements of each sensor to move them in a predictable manner and create an observable response in the sensors.
3. Measure the output response on each sensor.
4. Deactivate the internal stimulus on each sensor.
5. Calculate the difference between the sensor measurements from Step 1 (stimulus is off) and from Step 4 (stimulus is on).
6. Compare the difference with internal pass and fail criteria.
7. Report the pass and fail result to Register DIAG_STAT, Bit 5 (see Table 11).

Motion during the execution of this test can indicate a false failure.

Factory Calibration Restore

Use the following DIN sequence to set Register GLOB_CMD, Bit 1 = 1, to restore the factory default settings for the MSC_CTRL, DEC_RATE, and FILT_CTRL registers and to clear all user configurable bias correction settings: 0xE802, then 0xE900. Executing this command results in writing 0x0000 to the following registers: XG_BIAS_LOW, XG_BIAS_HIGH, YG_BIAS_LOW, YG_BIAS_HIGH, ZG_BIAS_LOW, ZG_BIAS_HIGH, XA_BIAS_LOW, XA_BIAS_HIGH, YA_BIAS_LOW, YA_BIAS_HIGH, ZA_BIAS_LOW, and ZA_BIAS_HIGH.

Bias Correction Update

Use the following DIN pin sequence to set Register GLOB_CMD, Bit 0 = 1, to trigger a bias correction using the correction factors from the CBE (see Table 112): 0xE801, then 0xE900.

Firmware Revision (FIRM_REV)**Table 115. FIRM_REV Register Definition**

| Addresses | Default | Access | Flash Backup |
|------------|----------------|--------|--------------|
| 0x6C, 0x6D | Not applicable | R | No |

Table 116. FIRM_REV Bit Definitions

| Bits | Description |
|--------|--|
| [15:0] | Firmware revision, binary coded decimal (BCD) format |

The FIRM_REV register (see Table 115 and Table 116) provides the firmware revision for the internal firmware. This register uses a BCD format where each nibble represents a digit. For example, if FIRM_REV = 0x0104, the firmware revision is 1.04.

Firmware Revision Day and Month (FIRM_DM)**Table 117. FIRM_DM Register Definition**

| Addresses | Default | Access | Flash Backup |
|------------|----------------|--------|--------------|
| 0x6E, 0x6F | Not applicable | R | No |

Table 118. FIRM_DM Bit Definitions

| Bits | Description |
|--------|---|
| [15:8] | Factory configuration month, BCD format |
| [7:0] | Factory configuration day, BCD format |

The FIRM_DM register (see Table 117 and Table 118) contains the month and day of the factory configuration date. Register FIRM_DM, Bits[15:8], contain digits that represent the month of the factory configuration. For example, November is the 11th month in a year and is represented by Register FIRM_DM, Bits[15:8] = 0x11. Register FIRM_DM, Bits[7:0], contain the day of factory configuration. For example, the 27th day of the month is represented by Register FIRM_DM, Bits[7:0] = 0x27.

Firmware Revision Year (FIRM_Y)**Table 119. FIRM_Y Register Definition**

| Addresses | Default | Access | Flash Backup |
|------------|----------------|--------|--------------|
| 0x70, 0x71 | Not applicable | R | No |

Table 120. FIRM_Y Bit Definitions

| Bits | Description |
|--------|--|
| [15:0] | Factory configuration year, BCD format |

The FIRM_Y register (see Table 119 and Table 120) contains the year of the factory configuration date. For example, the year, 2017, is represented by FIRM_Y = 0x2017.

Product Identification (PROD_ID)**Table 121. PROD_ID Register Definition**

| Addresses | Default | Access | Flash Backup |
|------------|---------|--------|--------------|
| 0x72, 0x73 | 0x4079 | R | No |

Table 122. PROD_ID Bit Definitions

| Bits | Description |
|--------|---------------------------------|
| [15:0] | Product identification = 0x4079 |

The PROD_ID register (see Table 121 and Table 122) contains the numerical portion of the device number (16,505). See Figure 41 for an example of how to use a looping read of this register to validate the integrity of the communication.

Serial Number (SERIAL_NUM)**Table 123. SERIAL_NUM Register Definition**

| Addresses | Default | Access | Flash Backup |
|------------|----------------|--------|--------------|
| 0x74, 0x75 | Not applicable | R | No |

Table 124. SERIAL_NUM Bit Definitions

| Bits | Description |
|--------|----------------------------|
| [15:0] | Lot specific serial number |

Scratch Registers (USER_SCR_1 to USER_SCR_3)**Table 125. USER_SCR_1 Register Definition**

| Addresses | Default | Access | Flash Backup |
|------------|----------------|--------|--------------|
| 0x76, 0x77 | Not applicable | R/W | Yes |

Table 126. USER_SCR_1 Bit Definitions

| Bits | Description |
|--------|--------------|
| [15:0] | User defined |

Table 127. USER_SCR_2 Register Definition

| Addresses | Default | Access | Flash Backup |
|------------|----------------|--------|--------------|
| 0x78, 0x79 | Not applicable | R/W | Yes |

Table 128. USER_SCR_2 Bit Definitions

| Bits | Description |
|--------|--------------|
| [15:0] | User defined |

Table 129. USER_SCR_3 Register Definition

| Addresses | Default | Access | Flash Backup |
|------------|----------------|--------|--------------|
| 0x7A, 0x7B | Not applicable | R/W | Yes |

Table 130. USER_SCR_3 Bit Definitions

| Bits | Description |
|--------|--------------|
| [15:0] | User defined |

The USER_SCR_1 (see Table 125 and Table 126), USER_SCR_2 (see Table 127 and Table 128), and USER_SCR_3 (see Table 129 and Table 130) registers provide three locations for the user to store information. For nonvolatile storage, use the manual flash memory update command (Register GLOB_CMD, Bit 3, see Table 114) after writing information to these registers.

Flash Memory Endurance Counter (FLSHCNT_LOW and FLSHCNT_HIGH)

Table 131. FLSHCNT_LOW Register Definition

| Addresses | Default | Access | Flash Backup |
|------------|----------------|--------|--------------|
| 0x7C, 0x7D | Not applicable | R | No |

Table 132. FLSHCNT_LOW Bit Definitions

| Bits | Description |
|--------|--------------------------------------|
| [15:0] | Flash memory write counter, low word |

Table 133. FLSHCNT_HIGH Register Definition

| Addresses | Default | Access | Flash Backup |
|------------|----------------|--------|--------------|
| 0x7E, 0x7F | Not applicable | R | No |

Table 134. FLSHCNT_HIGH Bit Definitions

| Bits | Description |
|--------|---------------------------------------|
| [15:0] | Flash memory write counter, high word |

The FLSHCNT_LOW (see Table 131 and Table 132) and FLSHCNT_HIGH (see Table 133 and Table 134) registers combine to provide a 32-bit, binary counter that tracks the number of flash memory write cycles. In addition to the number of write cycles, the flash memory has a finite service lifetime, which depends on the junction temperature. Figure 60 provides guidance for estimating the retention life for the flash memory at specific junction temperatures. The junction temperature is approximately 7°C above the case temperature.

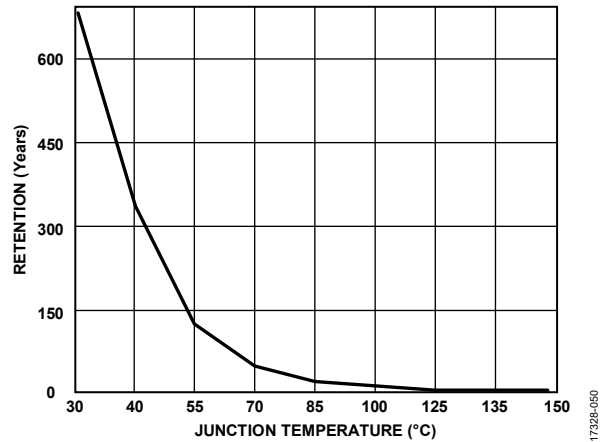

Figure 60. Flash Memory Retention

APPLICATIONS INFORMATION

ASSEMBLY AND HANDLING TIPS

Package Attributes

The ADIS16505 is a multichip module package that has a 100-ball BGA interface. This package has three basic attributes that influence its handling and assembly to the PCB of the system: the lid, the substrate, and the BGA pattern. The material of the lid is a liquid crystal polymer (LCP), and its nominal thickness is 0.5 mm. The substrate is a laminate that has a nominal thickness of 1.57 mm. The solder ball material is SAC305, and each ball has a nominal diameter of 0.75 mm (± 0.15 mm). The BGA pattern is a 10×10 array.

All electrical and physical connections are through the 10×10 array shown in Figure 62. The bottom view in Figure 66 shows additional features from the manufacture of the ADIS16505 that are not relevant to the mounting or use of the ADIS16505.

Assembly Tips

When attaching the ADIS16505 to a PCB, follow these guidelines:

- The ADIS16505 supports solder reflow attachment processes in accordance with J-STD-020E.
- Limit device exposure to one pass through the solder reflow process (no rework).
- The hole in the top of the lid (see Figure 61) provides venting and pressure relief during the assembly process of the ADIS16505. This hole must be kept clear while attaching the ADIS16505 to a PCB. Although, covering the hole in normal operation is not typically a problem.

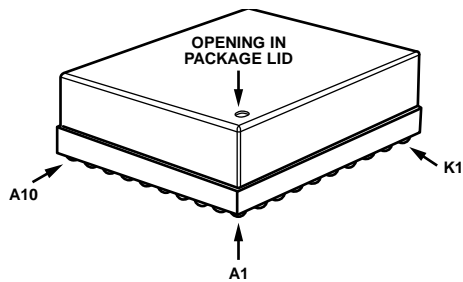

Figure 61. Pressure Relief Hole

- Use no clean flux and avoid exposing the device to cleaning solvents that can penetrate the inside of the ADIS16505 through multiple paths.
- Manage moisture exposure prior to the solder reflow processing in accordance with J-STD-033, Moisture Sensitivity Level 5.
- Avoid exposing the ADIS16505 to mechanical shock survivability that exceeds the maximum rating in Table 3. In standard PCB processing, high speed handling equipment and panel separation processes often present the most risk of introducing harmful levels of mechanical shock survivability.

PCB Layout Suggestions

Figure 62 shows an example of the pad design and layout for the ADIS16505 on a PCB. This example uses a solder mask opening with a diameter of 0.73 mm, around a metal pad that has a diameter of 0.56 mm. When using a material for the system PCB that has similar thermal expansion properties as the substrate material of the ADIS16505, the system PCB can also use the solder mask to define the pads that support attachment to the balls of the ADIS16505. The coefficient of thermal expansion (CTE) in the substrate of the ADIS16505 is approximately 14 ppm/ $^{\circ}$ C.

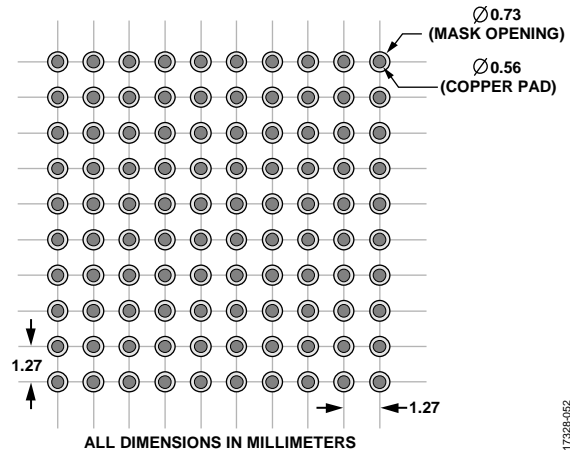

Figure 62. Recommend PCB Pattern, Solder Mask Defined Pads

Underfill

Underfill can be a useful technique in managing certain threats to the integrity of the solder joints of the ADIS16505, including peeling stress and extended exposure to vibration. When selecting underfill material and developing an application and curing process, ensure that the material fills the gap between each surface (the ADIS16505 substrate and system PCB) and adheres to both surfaces. The ADIS16505 does not require the use of underfill materials in applications that do not anticipate exposure to these types of mechanical stresses and when the CTE of the system PCB is close to the same value as the CTE of the substrate of the ADIS16505 (~ 14 ppm/ $^{\circ}$ C).

Process Validation and Control

These guidelines provide a starting point for developing a process for attaching the ADIS16505 to a system PCB. Because each system and situation can present unique requirements for this attachment process, ensure that the process supports optimal solder joint integrity, verify that the final system meets all environmental test requirements, and establish observation and control strategies for all key process attributes (for example, peak temperatures, dwell times, and ramp rates).

POWER SUPPLY CONSIDERATIONS

The ADIS16505 contains 6 μF of decoupling capacitance across the VDD and GND pins. When the VDD voltage rises from 0 V to 3.3 V, the charging current for this capacitor bank imposes the following current profile (in amperes):

$$I_{DD}(t) = C \frac{dVDD}{dt} = 6 \times 10^{-6} \times \frac{dVDD(t)}{dt}$$

where:

$I_{DD}(t)$ is the current demand on the VDD pin during the initial power supply ramp, with respect to time.

C is the internal capacitance across the VDD and GND pins (6 μF). $VDD(t)$ is the voltage on the VDD pin, with respect to time.

For example, if VDD follows a linear ramp from 0 V to 3.3 V, in 66 μs, the charging current is 300 mA for that timeframe. The ADIS16505 also contains embedded processing functions that present transient current demands during initialization or reset recovery operations. During these processes, the peak current demand reaches 250 mA and occurs at a time that is approximately 40 ms after VDD reaches 3.0 V (or ~40 ms after initiating a reset sequence).

EVALUATION TOOLS

Breakout Boards

The ADIS16505 has three difference breakout boards, which provide a simple way to connect an ADIS16505 model and an existing embedded processor platform. Table 135 provides a list of the model numbers for each breakout board, along with the ADIS16505 model that is on each breakout board. Figure 63 shows the ADIS16505-2 which is identical to the ADIS16505-1 and ADIS16505-3 boards.



Figure 63. ADIS16505-2 Breakout Board

Table 135. Breakout Board Models

| Breakout Board Model | ADIS16505 Model |
|----------------------|-----------------|
| ADIS16505-1/PCBZ | ADIS16505-1BMLZ |
| ADIS16505-2/PCBZ | ADIS16505-2BMLZ |
| ADIS16505-3/PCBZ | ADIS16505-3BMLZ |

The electrical interface (J1) on each breakout board comes from a dual row, 2 mm pitch, 16-pin interface, which supports standard ribbon cabling (1 mm pitch). Table 136 provides the J1 pin assignments, which support direct connection with an embedded processor board using standard ribbon cables. Although each case may present its own set of sensitivities (such as electromagnetic interference (EMI)), these boards can typically support reliable communication over ribbon cables up to 20 cm in length.

Table 136. J1 Pin Assignments, Breakout Board

| J1 Pin Number | Signal | Function |
|---------------|--------|--------------|
| 1 | RST | Reset |
| 2 | SCLK | SPI |
| 3 | CS | SPI |
| 4 | DOUT | SPI |
| 5 | NC | No connect |
| 6 | DIN | SPI |
| 7 | GND | Ground |
| 8 | GND | Ground |
| 9 | GND | Ground |
| 10 | VDD | Power, 3.3 V |
| 11 | VDD | Power, 3.3 V |
| 12 | VDD | Power, 3.3 V |
| 13 | DR | Data ready |
| 14 | SYNC | Input clock |
| 15 | NC | No connect |
| 16 | NC | No connect |

Figure 64 provides a top view of the breakout board, including dimensional locations for all the key mechanical features, such as the mounting holes and the 16-pin header. Figure 65 provides an electrical schematic for this breakout board. For additional information, refer to the [ADIS1650x-x/PCBZ Breakout Board Wiki Guide](#).

PC-Based Evaluation, EVAL-ADIS2

In addition to supporting quick prototype connections between the ADIS16505 and an embedded processing system, J1 on the breakout boards also connects directly to J1 on the EVAL-ADIS2 evaluation system. When used in conjunction with the [IMU Evaluation Software for the EVAL-ADISX Platforms](#), the EVAL-ADIS2 provides a simple, functional test platform that allows users to configure and collect data from the ADIS16505 IMUs.

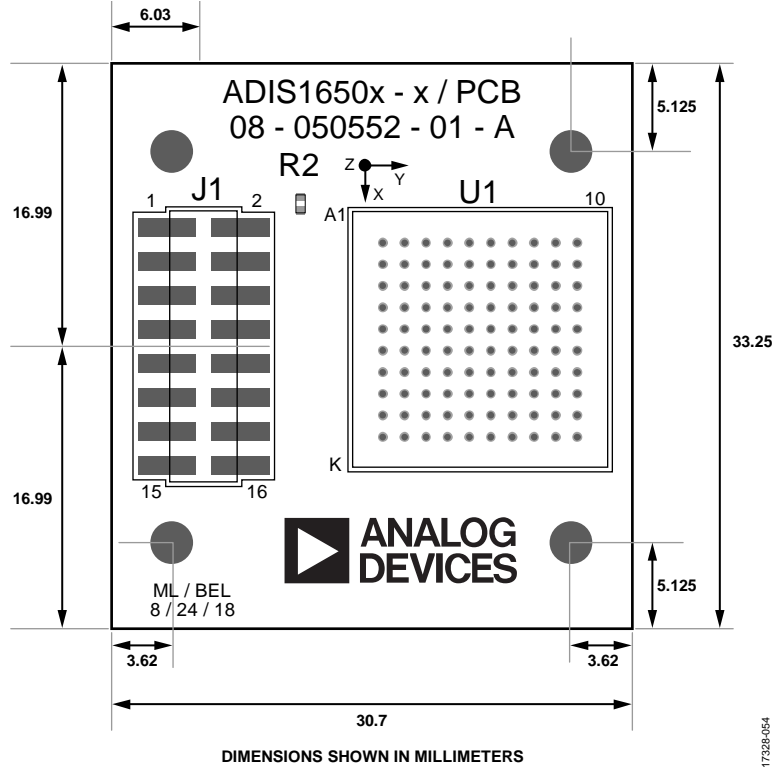

Figure 64. Top View of the ADIS16505 Breakout Board

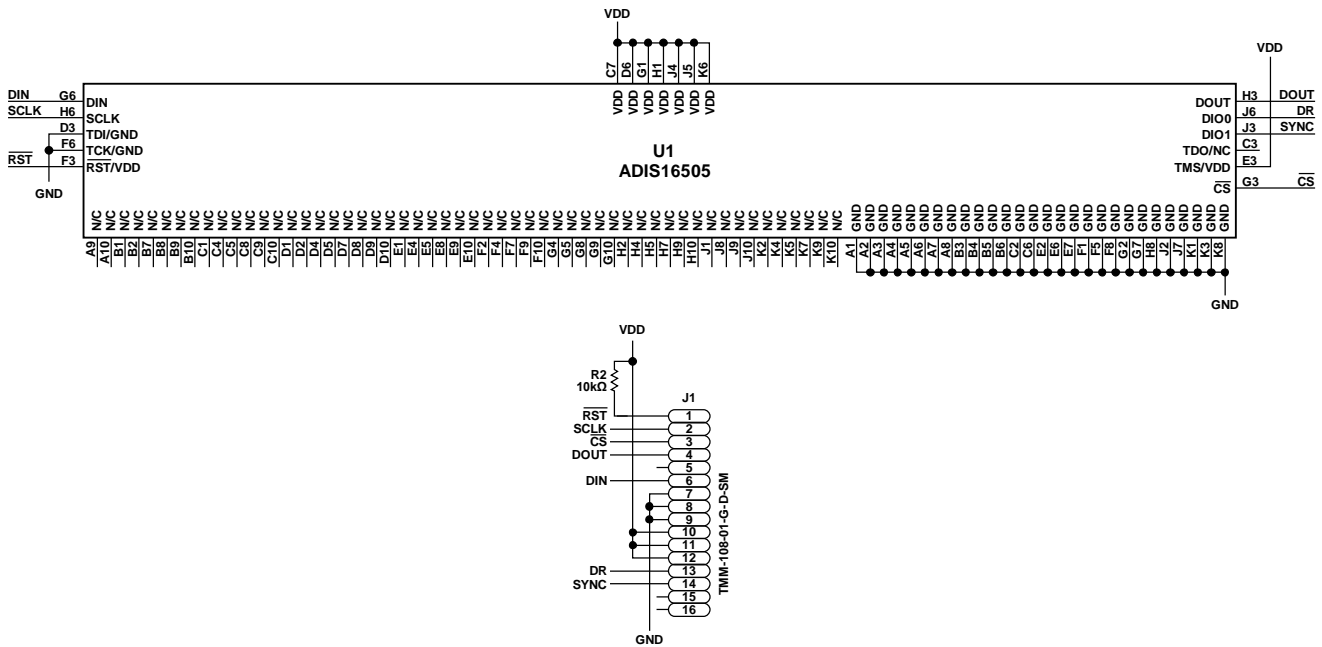

Figure 65. ADIS16505 Breakout Board Schematic

PACKAGING AND ORDERING INFORMATION

OUTLINE DIMENSIONS

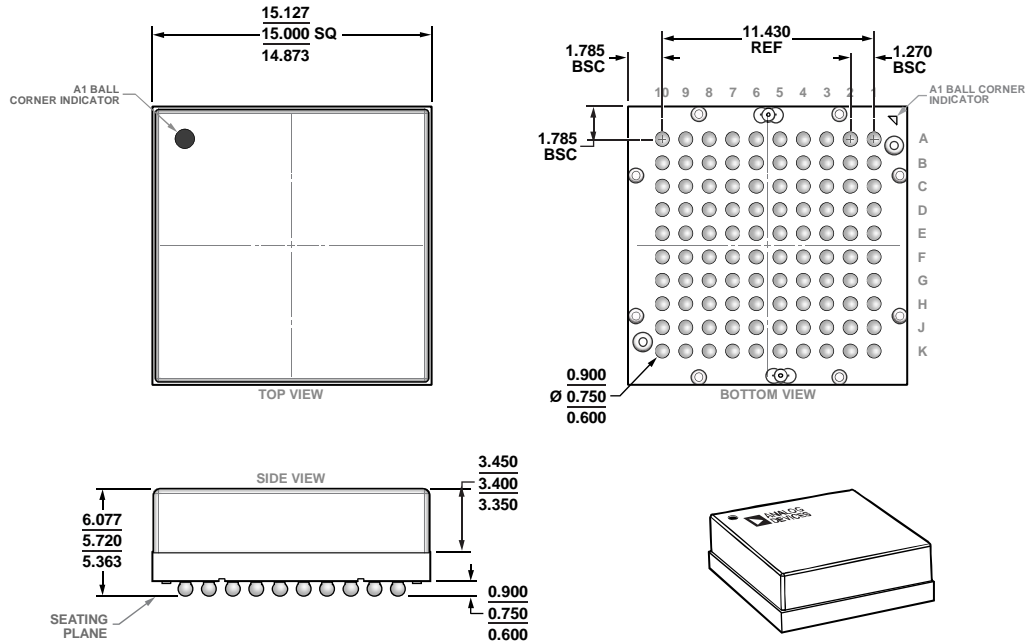

Figure 66. 100-Ball Ball Grid Array Module [BGA]
(ML-100-1)
Dimensions shown in millimeters

04-11-2018-A

ORDERING GUIDE

| Model ¹ | Temperature Range | Package Description | Package Option |
|--------------------|-------------------|---------------------------------------|----------------|
| ADIS16505-1BMLZ | -40°C to +105°C | 100-Ball Ball Grid Array Module [BGA] | ML-100-1 |
| ADIS16505-2BMLZ | -40°C to +105°C | 100-Ball Ball Grid Array Module [BGA] | ML-100-1 |
| ADIS16505-3BMLZ | -40°C to +105°C | 100-Ball Ball Grid Array Module [BGA] | ML-100-1 |
| ADIS16505-1/PCBZ | | ADIS16505-1 Breakout Board | |
| ADIS16505-2/PCBZ | | ADIS16505-2 Breakout Board | |
| ADIS16505-3/PCBZ | | ADIS16505-3 Breakout Board | |

¹ Z = RoHS Compliant Part.