

AlGaInP Visible Laser Diode

ADL-65075SL
6-2D-LD65-016_Rev.01

★ $\phi 3.3\text{mm}$ Mini Package!
7mW Reliable Operation

• Features

1. Smallest package
2. Low operating current

• Applications

1. Mini size optical modules
2. Laser sensor

• Absolute maximum ratings

| Parameter | Symbol | Condition | Rating | Unit |
|----------------------|----------|-----------|---------|--------------------|
| Light output power | P_O | CW | 8 | mW |
| Reverse voltage (LD) | V_{RL} | - | 2 | V |
| Reverse voltage (PD) | V_{RD} | - | 30 | V |
| Forward current (PD) | I_{FD} | - | 10 | mA |
| Case temperature | T_C | - | -10~+70 | $^{\circ}\text{C}$ |
| Storage temperature | T_S | - | -40~+85 | $^{\circ}\text{C}$ |

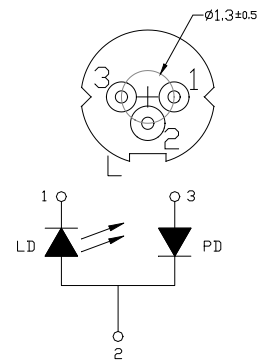
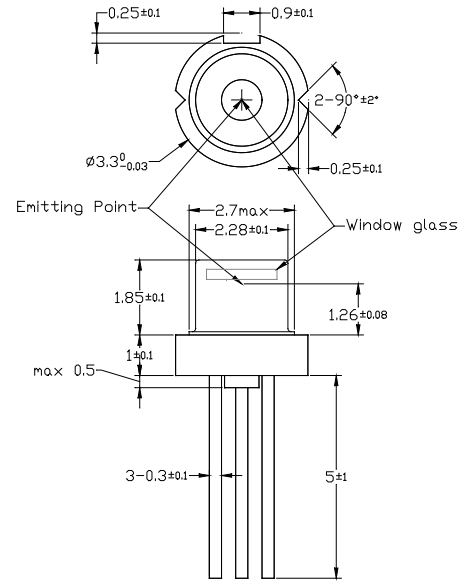

• Electrical and optical characteristics ($T_C=25^{\circ}\text{C}$)

| Parameter | Symbol | Min. | Typ. | Max. | Unit | Conditions |
|-----------------------------------|------------------------------|------|------|------|---------------|------------------------------------|
| Peak wavelength | λ | 645 | 655 | 660 | nm | $P_o=7\text{mW}$ |
| Threshold current | I_{th} | - | 20 | 25 | mA | $P_o=1\sim 2\text{mW}$ |
| Operating current | I_{op} | - | 25 | 35 | mA | $P_o=7\text{mW}$ |
| Operating voltage | V_{op} | - | 2.2 | 2.5 | V | $P_o=7\text{mW}$ |
| Differential efficiency | η | 0.7 | 0.9 | 1.2 | mW/mA | $P_o=5\sim 7\text{mW}$ |
| Monitor current | I_m | 0.1 | 0.2 | 0.3 | mA | $P_o=7\text{mW}, V_{RD}=5\text{V}$ |
| Parallel divergence angle | $\theta_{ }$ | 6 | 9 | 12 | deg | $P_o=7\text{mW}$ |
| Perpendicular divergence angle | θ_{\perp} | 25 | 28 | 32 | deg | |
| Parallel FFP deviation angle | $\Delta\theta_{ }$ | -3 | 0 | +3 | deg | |
| Perpendicular FFP deviation angle | $\Delta\theta_{\perp}$ | -3 | 0 | +3 | deg | |
| Emission point accuracy | $\Delta x \Delta y \Delta z$ | -80 | 0 | +80 | μm | |

• Precautions

- * Do not operate the device above maximum ratings. Doing so may cause unexpected and permanent damage to the device.
- * Take precautions to avoid electrostatic discharge and/or momentary power spikes. A change in the characteristics of the laser or premature failure may result.
- * Proper heat sinking of the device assures stability and lifetime. Always ensure that maximum operating temperatures are not exceeded.
- * Observing visible or invisible laser beams with the human eye directly, or indirectly, can cause permanent damage. Use a camera to observe the laser.
- * No laser device should be used in any application or situation where life or property is at risk in event of device failure.
- * Specifications are subject to change without notice. Ensure that you have the latest specification by contacting us prior to purchase or use of the product

* For reference only. Contents above are subject to change without notice.

Contact

For US, Canada Ayase America Inc. e-mail: info@ayaseamerica.com +1-408-988-5277
 For EU Ayase Europe GmbH e-mail: info@ayase-europe.de +49-0-6122-533-811
 For Japan Ayase Co., Ltd. e-mail: info@ayasecorporation.com +81-45-532-9501

AlGaInP Visible Laser Diode

ADL-65075SL
6-2D-LD65-016_Rev.01

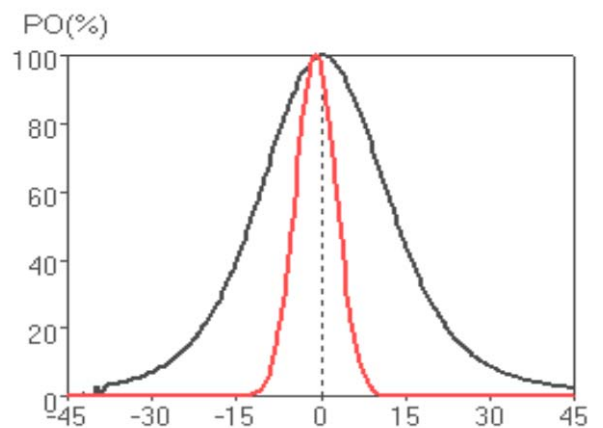
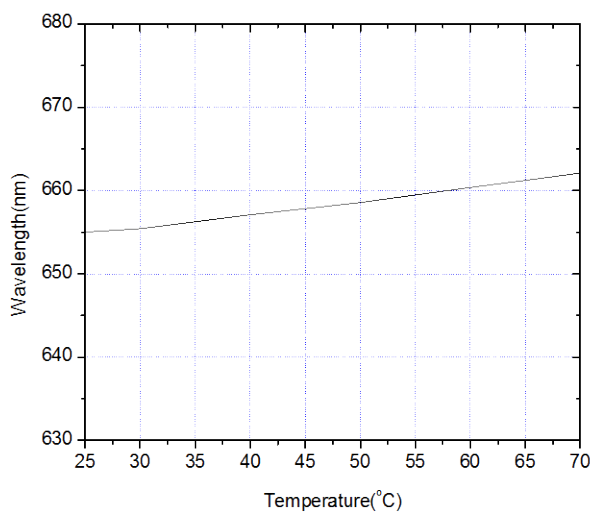
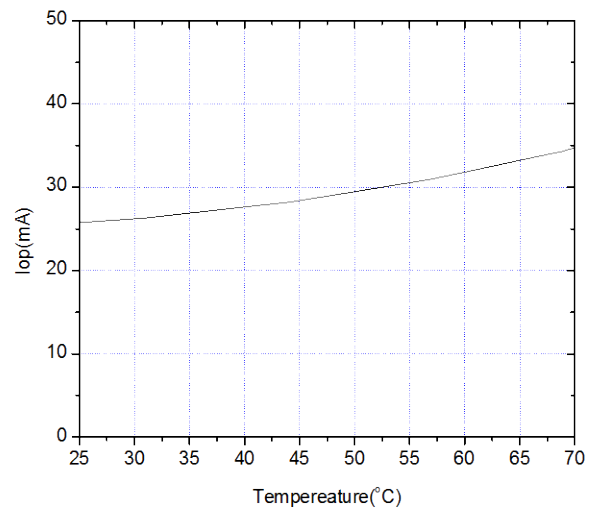
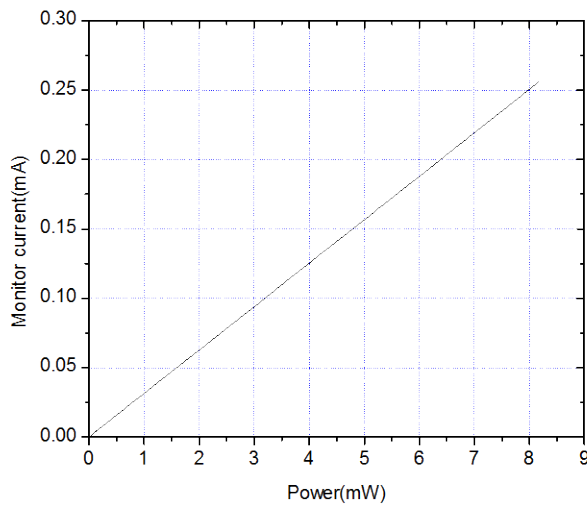
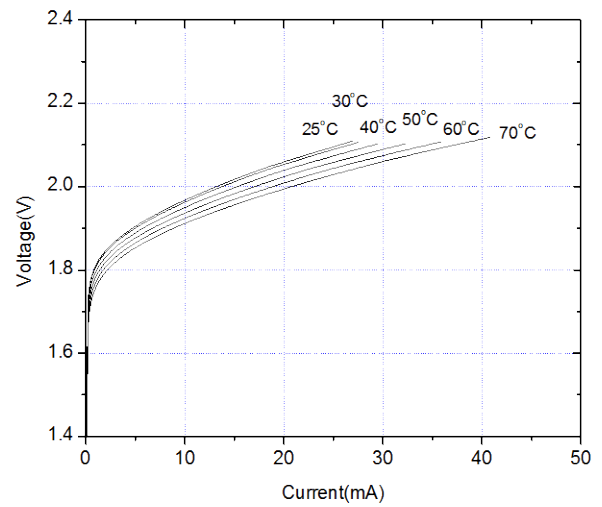
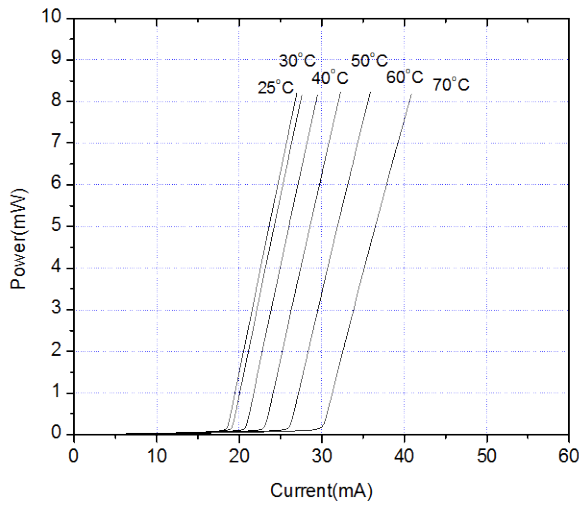

* For reference only. Contents above are subject to change without notice.

Contact

For US, Canada
For EU
For Japan

Ayase America Inc.
Ayase Europe GmbH
Ayase Co., Ltd.

e-mail: info@ayaseamerica.com
e-mail: info@ayase-europe.de
e-mail: info@ayasecorporation.com

+1-408-988-5277
+49-0-6122-533-811
+81-45-532-9501

