

# ADNS-7700

## One chip USB LaserStream™ Mouse Sensors



### Data Sheet



#### Description

The ADNS-7700 series are compact, low cost, one chip USB LaserStream™ mouse sensors designed for implementation of a non-mechanical tracking engine in computer mice.

This ADNS-7700 sensor is a 22-pin integrated molded lead-frame DIP package. It comprises a USB controller and LaserStream navigation sensor with VCSEL integrated within a single package. It is designed to be used with the ADNS-6180-001 trim lens or ADNS-6180-002 wide trim lens to achieve the LaserStream performance featured in this document. These parts provide a complete and compact navigation system with no moving parts and precision optical alignment to facilitate high volume assembly. Avago has pre-calibrated the laser power prior shipment, thus NO laser power calibration is required at manufacturer site, therefore reducing assembly time and associated cost.

The motion output is a selectable 8/12/16-bit USB data reporting format. This device is compliant to USB Revision 2.0 low speed specification. The ADNS-7700 series are designed with on-chip One-Time-Programmable (OTP) memory. This enables device configuration flexibility for the manufacturer to cater for various market segments.

#### Theory of Operation

The ADNS-7700 is based on Laser-Stream navigation technology that measures changes in position by optically acquiring sequential surface images (per frames) and mathematically determining the direction and magnitude of motion movement.

It contains an Image Acquisition System (IAS), a Digital Signal Processor (DSP) and USB stream output. The IAS acquires microscopic surface images via the lens. These images are processed by the DSP to determine the direction and distance of motion. The DSP generates the  $\Delta x$  and  $\Delta y$  relative displacement values which are converted to USB motion data.

#### Features

- One chip USB laser mouse sensor with VCSEL integrated in single package
- LaserStream™ navigation technology
- USB 2.0 Low Speed Compliance
- Meets HID Revision 1.11
- Single 5.0 volts power supply
- Compliance to IEC/EN 60825-1 Class 1 Eye Safety
  - Pre-calibrated laser power prior shipment
  - Class 1 eye safety AEL
  - On-chip Laser fault detect circuitry
- High speed motion detection at 45 inches per second (ips) and acceleration up to 20g
- Input buttons: 3 or 5-buttons
- Mechanical Z-Wheel interface for vertical scroll
- On-chip OTP memory for device configuration flexibility without any external software driver:
  - Enable/Disable Tilt-Wheel\* function that supports horizontal scroll in Microsoft Vista OS.
  - 8/12/16-bit USB motion data reporting
  - Resolution
    - Programmable from 400-2400 counts per inch (cpi) with ~100cpi incremental step
    - 3 selections of On-the-Fly (OTF) resolution mode setting
- KeyMap (KM) for keyboard shortcut key
- Customizable VID, PID, Manufacturer string and Product string
- 4-axis sensor rotations: 0°, 90°, 180° or 270°

#### Applications

- Corded laser mice
- Integrated input devices

\* Disclaimer: All designers and manufacturers of this design must assure that they have all necessary intellectual property rights

## Ordering Part Numbers:

Description for USB LaserStream Mouse Sensor				
Part Number	Input Button	Tilt-Wheel	OTF Resolution	KeyMap
ADNS-7700-H4MY	3-buttons	Programmable	–	–
ADNS-7700-HAMY	3-buttons	Programmable	Programmable	–
ADNS-7700-HCMY	5-buttons	Programmable	Programmable	–
ADNS-7700-HMMY	5-buttons	Programmable	Programmable	Programmable

## Package Pinout

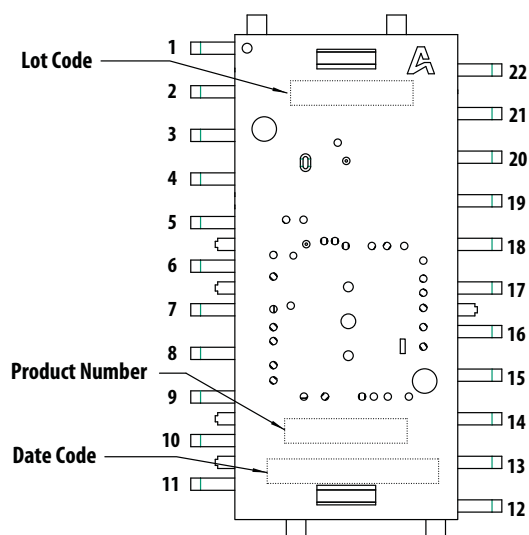

Figure 1. Device Pinout

Item	Marking	Remarks
Product Number	A7700	
Date Code	XYWWZV	X = Subcon Code YYWW = Date Code Z = Sensor Die Source V = VCSEL Die Source
Lot Code	VVV	Numeric

Table 1. Pin Name Description

Pin Name	Description	Pin Name	Description
-VCSEL	Negative terminal of VCSEL	B1	Left button input (LB)
+VCSEL	Positive terminal of VCSEL	B2	Right button input (RB)
D+	USB D+ line	B3	Middle button input (MB)
D-	USB D- line	B4	Back button input (BB)
OSC_IN	Ceramic resonator input	B5	Forward button input (FB)
OSC_OUT	Ceramic resonator output	TW1*	Left tilt input
VDD5	5-Volt Power (USB VBUS)	TW2*	Right tilt input
DGND	System ground	LED0	Resolution LED indicator output
AGND	Analog ground	LED1	Resolution LED indicator output
LASER_GND	LASER ground	LED2	Resolution LED indicator output
REFA	Reference voltage capacitor	ZA	Z-Wheel quadrature input
REFB	Reference voltage capacitor	ZB	Z-Wheel quadrature input
REFC	Reference coupling	KM1	KeyMap 1 button input
OTF	OTF Resolution button input	KM2	KeyMap 2 button input
OTF_L	OTF Resolution Long Press button input	NC	No Connection

**Table 2a. Device Pinout Configurations**

Pin No	ADNS-7700-H4MY		ADNS-7700-HAMY				ADNS-7700-HCMY			
	3B	3B + TW	3B	3B + TW	3B + OTF + 3LED	3B + TW + OTF	5B	5B + TW	5B + OTF	4B + TW + OTF
1	+VCSEL	+VCSEL	+VCSEL	+VCSEL	+VCSEL	+VCSEL	+VCSEL	+VCSEL	+VCSEL	+VCSEL
2	NC	TW2*	NC	TW2*	LED0	TW2*	NC	TW2*	OTF	TW2*
3	NC	TW1*	NC	TW1*	LED1	TW1*	NC	TW1*	NC	TW1*
4	LASER_GND	LASER_GND	LASER_GND	LASER_GND	LASER_GND	LASER_GND	LASER_GND	LASER_GND	LASER_GND	LASER_GND
5	REFB	REFB	REFB	REFB	REFB	REFB	REFB	REFB	REFB	REFB
6	VDD5	VDD5	VDD5	VDD5	VDD5	VDD5	VDD5	VDD5	VDD5	VDD5
7	REFC	REFC	REFC	REFC	REFC	REFC	REFC	REFC	REFC	REFC
8	ZA	ZA	ZA	ZA	ZA	ZA	ZA	ZA	ZA	ZA
9	ZB	ZB	ZB	ZB	ZB	ZB	ZB	ZB	ZB	ZB
10	AGND	AGND	AGND	AGND	AGND	AGND	AGND	AGND	AGND	AGND
11	REFA	REFA	REFA	REFA	REFA	REFA	REFA	REFA	REFA	REFA
12	DGND	DGND	DGND	DGND	DGND	DGND	DGND	DGND	DGND	DGND
13	OSC_OUT	OSC_OUT	OSC_OUT	OSC_OUT	OSC_OUT	OSC_OUT	OSC_OUT	OSC_OUT	OSC_OUT	OSC_OUT
14	OSC_IN	OSC_IN	OSC_IN	OSC_IN	OSC_IN	OSC_IN	OSC_IN	OSC_IN	OSC_IN	OSC_IN
15	NC	NC	NC	NC	OTF	OTF	B5	B5	B5	OTF
16	NC	NC	NC	NC	LED2	NC	B4	B4	B4	B4
17	B3	B3	B3	B3	B3	B3	B3	B3	B3	B3
18	B2	B2	B2	B2	B2	B2	B2	B2	B2	B2
19	B1	B1	B1	B1	B1	B1	B1	B1	B1	B1
20	D-	D-	D-	D-	D-	D-	D-	D-	D-	D-
21	D+	D+	D+	D+	D+	D+	D+	D+	D+	D+
22	-VCSEL	-VCSEL	-VCSEL	-VCSEL	-VCSEL	-VCSEL	-VCSEL	-VCSEL	-VCSEL	-VCSEL

**Table 2b. Device Pinout Configurations**

Pin No	ADNS-7700-HMMY						
	5B	5B + TW	5B + KM1/OTF_L	5B + KM1/OTF_L + KM2	4B + TW + KM1/OTF_L	3B + TW + KM1/OTF_L	3B + TW + KM1/OTF_L + KM2
1	+VCSEL	+VCSEL	+VCSEL	+VCSEL	+VCSEL	+VCSEL	+VCSEL
2	NC	TW2*	KM1/OTF_L	KM1/OTF_L	TW2*	TW2*	TW2*
3	NC	TW1*	NC	KM2	TW1*	TW1*	TW1*
4	LASER_GND	LASER_GND	LASER_GND	LASER_GND	LASER_GND	LASER_GND	LASER_GND
5	REFB	REFB	REFB	REFB	REFB	REFB	REFB
6	VDD5	VDD5	VDD5	VDD5	VDD5	VDD5	VDD5
7	REFC	REFC	REFC	REFC	REFC	REFC	REFC
8	ZA	ZA	ZA	ZA	ZA	ZA	ZA
9	ZB	ZB	ZB	ZB	ZB	ZB	ZB
10	AGND	AGND	AGND	AGND	AGND	AGND	AGND
11	REFA	REFA	REFA	REFA	REFA	REFA	REFA
12	DGND	DGND	DGND	DGND	DGND	DGND	DGND
13	OSC_OUT	OSC_OUT	OSC_OUT	OSC_OUT	OSC_OUT	OSC_OUT	OSC_OUT
14	OSC_IN	OSC_IN	OSC_IN	OSC_IN	OSC_IN	OSC_IN	OSC_IN
15	B5	B5	B5	B5	KM1/OTF_L	KM1/OTF_L	KM1/OTF_L
16	B4	B4	B4	B4	B4	NC	KM2
17	B3	B3	B3	B3	B3	B3	B3
18	B2	B2	B2	B2	B2	B2	B2
19	B1	B1	B1	B1	B1	B1	B1
20	D-	D-	D-	D-	D-	D-	D-
21	D+	D+	D+	D+	D+	D+	D+
22	-VCSEL	-VCSEL	-VCSEL	-VCSEL	-VCSEL	-VCSEL	-VCSEL

\* Disclaimer: All designers and manufacturers of this design must assure that they have all necessary intellectual property rights.

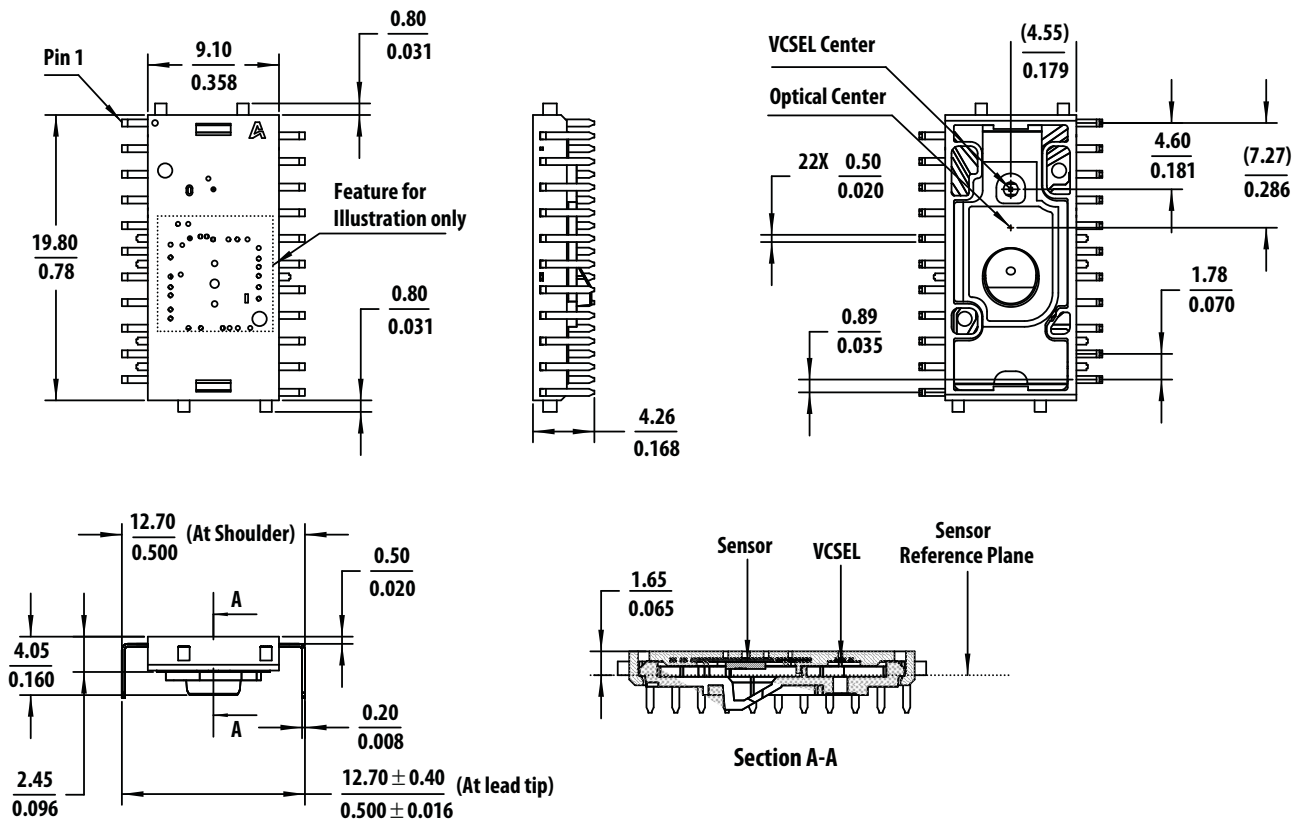

**NOTES: (Unless otherwise specified)**

1. Dimensions in millimeter / inches.
2. Dimensional tolerance: ± 0.1mm.
3. Coplanarity of leads: 0.1mm.
4. Lead pitch tolerance: ± 0.15mm.
5. Non-cumulative pitch tolerance: ± 0.15mm.
6. Angular tolerance: ± 3°
7. Maximum flash: 0.2mm.
8. Chamfer (25° x 2) on the taper side of the lead.
9. Brackets ( ) indicate reference dimension.
10. Document Number: LSR\_SOC\_INT\_22A\_Pkg\_001

Figure 2. Package outline drawing

**CAUTION:** It is advised that normal static precautions be taken in handling and assembly of this component to prevent damage and/or degradation which may be induced by ESD.

# Assembly Drawings

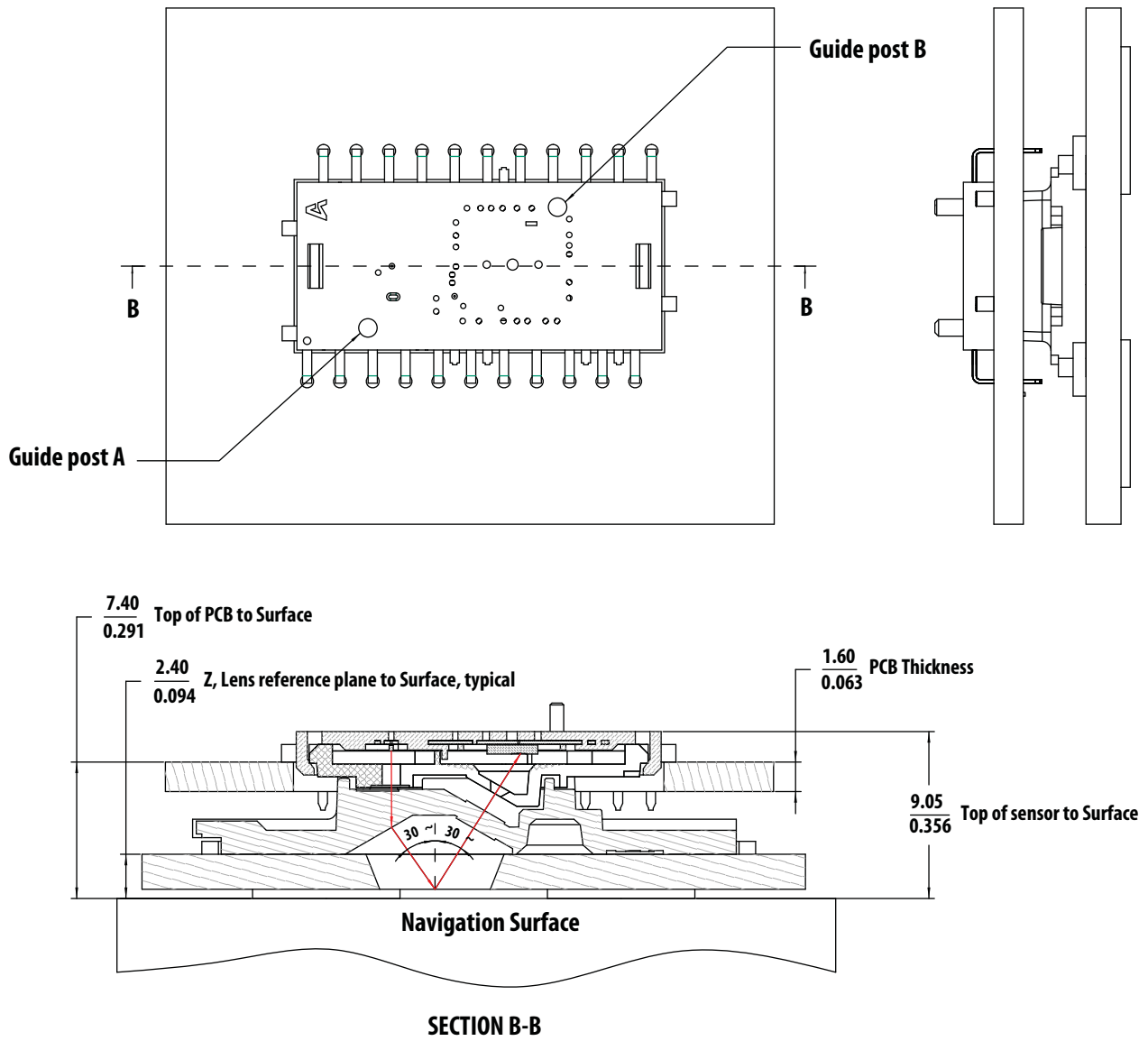
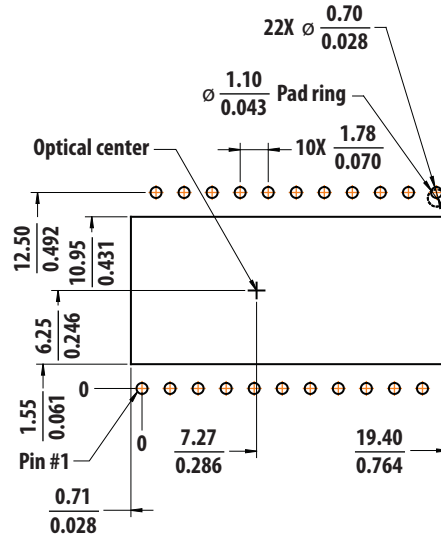

Figure 3. 2D assembly drawing of ADNS-7700 sensor coupled with ADNS-6180-002 lens, PCB & base plate

As shown in Figure 5, the components self-align as they are mounted onto defined features on the base plate. The ADNS-7700 sensor is designed for mounting on a through-hole PCB, looking down. The guide holes in the sensor package mates and self-aligns with the guide posts in the ADNS-6180-001 or ADNS-6180-002 lens.

The integrated VCSEL is used for the illumination, provides a laser diode with a single longitudinal and a single transverse mode. Together with the VCSEL contained in the sensor package, the ADNS-6180-001 or ADNS-6180-002 lens provides directed illumination and optical imaging necessary for the operation of the sensor. The lens is a precision molded optical component and should be handled with care to avoid scratching and contamination on the optical surfaces.

3D drawing files in STEP or IGES format for the sensor, lens and base plate describing the components and base plate molding features for the lens and PCB alignment is available.



Dimensions in mm/inches

Figure 4. Recommended PCB mechanical cutouts and spacing

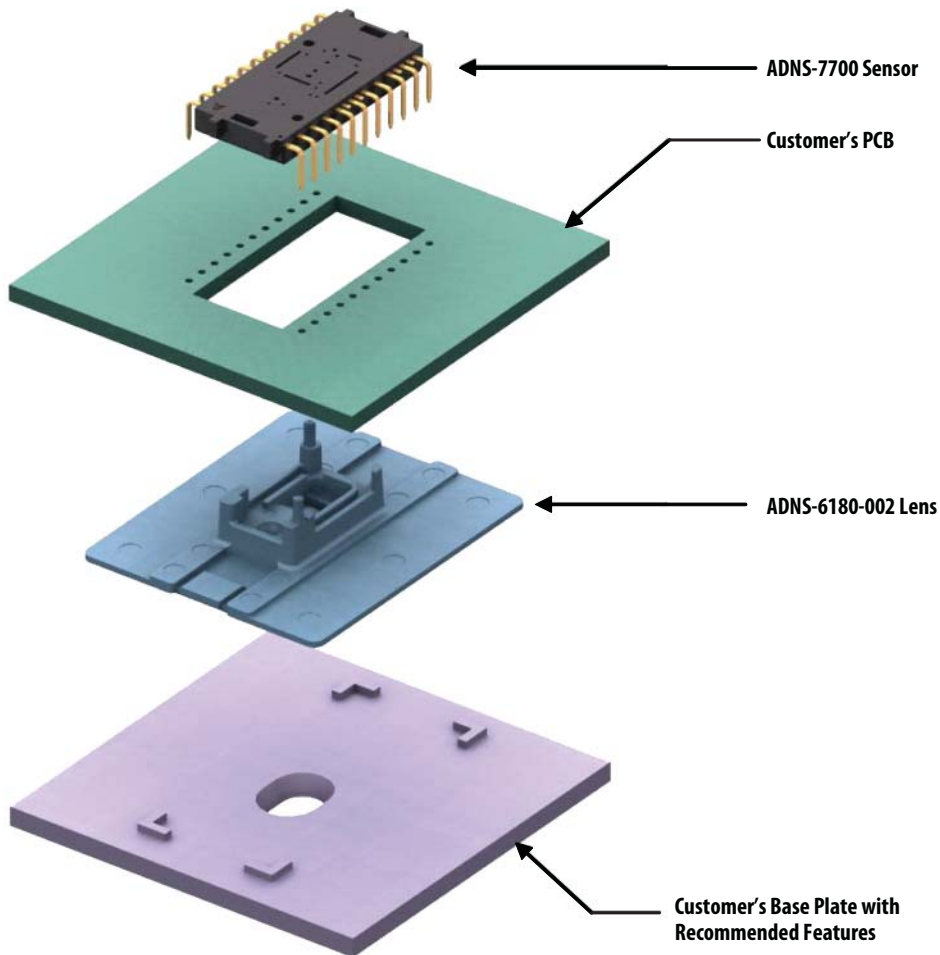

Figure 5. Exploded view drawing of ADNS-7700 sensor coupled with ADNS-6180-002 lens, PCB & base plate

# Application Schematics

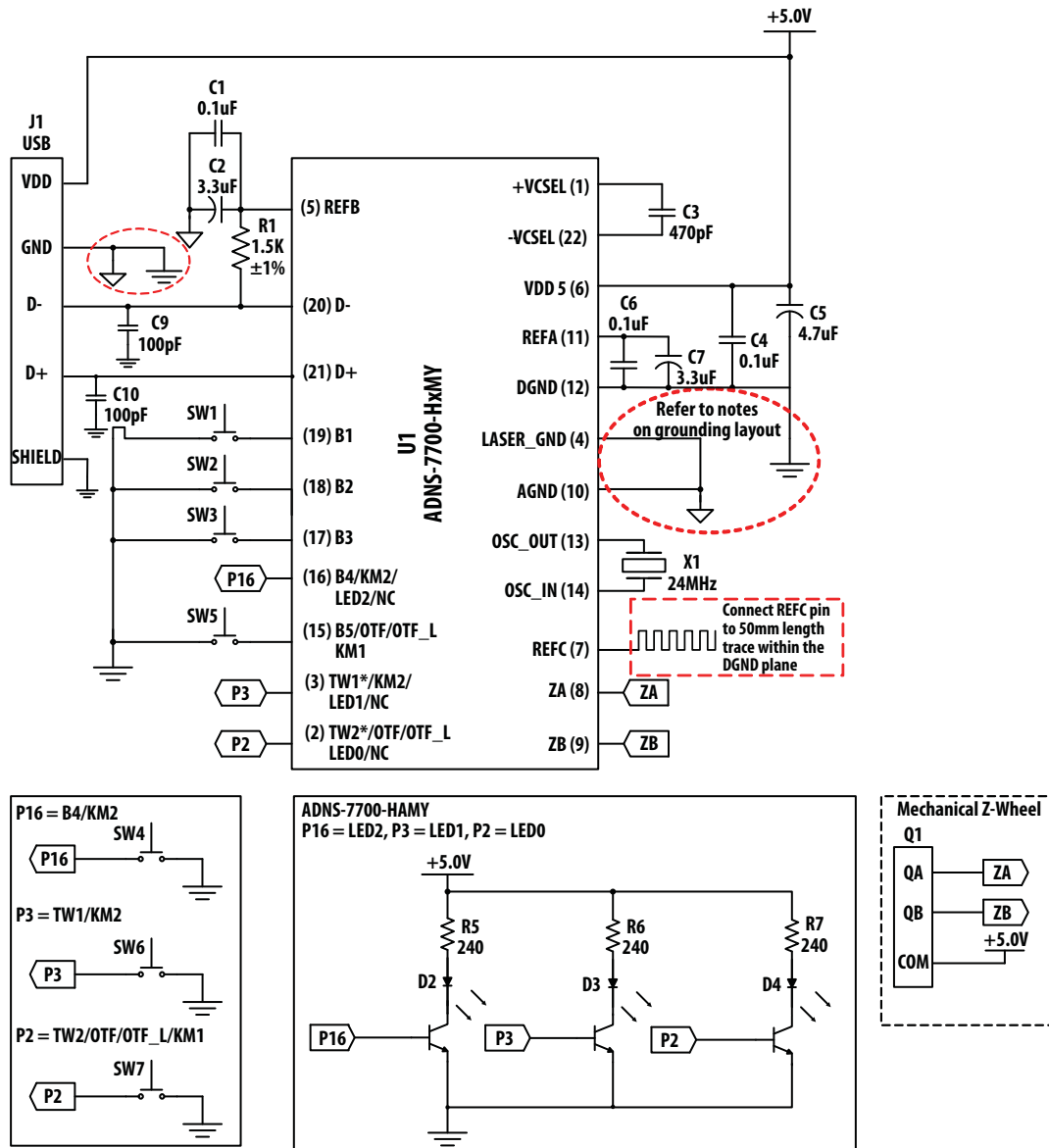

Figure 6. ADNS-7700 Sensor's Application Schematics

\* DISCLAIMER: ALL DESIGNERS AND MANUFACTURERS OF THIS DESIGN MUST ASSURE THAT THEY HAVE ALL NECESSARY INTELLECTUAL PROPERTY RIGHTS.



## PCB Layout Considerations:

1. The DGND and AGND paths *MUST* be layout as far as possible and connected together at the USB ground point with star topology. Ensure large grounding plane on the PCB layout for better performance on ESD and EFTB.
2. All caps *MUST* be as close to VDD5, REFA, REFB & +VCSEL sensor pins as possible and ground at the DGND and AGND plane that connected to USB GND, with trace length less than 5mm.
3. 1.5k $\Omega$  pullup resistor (R1) should be  $\pm$  1% tolerance and connected to REFB pin with shortest possible trace length.
4. Ceramic non-polarity caps and tantalum polarity caps are recommended.
5. Caps should have less than 5nH of self inductance.
6. Caps connected to VDD5 *MUST* have less than 0.2 $\Omega$  ESR.
7. REFC pin requires an open ended trace of min 50 mm lengths within DGND plane for EFTB performance improvement. Refer to System Design Recommendations Application Note.
8. Do not use jumper on ground plane, D+ and D- paths.
9. Data lines (D+ and D-) should be as far as possible from resonator.

## PCB Assembly Considerations

1. Insert the sensor package and all other electrical components into the application PCB. To maintain the Z alignment of sensor package, the sensor reference plane can be sit directly on the PCB.
2. This sensor package is only qualified for wave-solder process.
3. Wave solder the entire assembly in a non-wash solder process utilizing solder fixture. The solder fixture is needed to protect the sensor during the solder process shielding the optical aperture from direct solder contact.
4. Place the lens onto the base plate. Care must be taken to avoid contamination and scratches on the optical surfaces.
5. Hold the PCB vertically and remove the Kapton tape attached to the respective aperture of sensor and VCSEL. During the removal process of Kapton tape, care must be taken to prevent contaminants from entering through the apertures. Do NOT place the PCB facing upwards during the entire mouse assembly process.

6. Place the PCB over the lens onto base plate. The sensor package should be self-aligned and locked to the lens by the lens' alignment guide posts. The optical center reference for the PCB is set by base plate and lens. Note that the PCB movement due to button presses must be minimized to maintain good optical alignment.
7. Optional: The lens can be permanently locked to the sensor package by melting the lens' guide posts over the sensor with heat staking process.
8. Then, install the mouse top case. There *MUST* be feature in the top case (or other area) to press down onto the sensor or PCB assembly to ensure the sensor and lens are interlocked to correct vertical height.

## Design Considerations for Improving ESD Performance

For improved electrostatic discharge performance, typical creepage and clearance distance are shown in the table below. Assumption: base plate construction as per the Avago supplied 3D model file when use with ADNS-6180-001 trim lens or ADNS-6180-002 wide trim lens. The lens flange can be sealed (i.e. glued) to the base plate. Note that the lens material is polycarbonate and therefore, cyanoacrylate based adhesives or other adhesives that may damage the lens should NOT be used.

Typical Distance (mm)	ADNS-6180-001 trim lens	ADNS-6180-002 wide trim lens
Creepage	5.5	17.5
Clearance	1.8	1.8

## Regulatory Requirements

- Passes FCC B and worldwide analogous emission limits when assembled into a mouse with unshielded cable and following Avago Technologies recommendations.
- Passes EN 61000-4-4/IEC 801-4 EFT tests when assembled into a mouse with shielded cable and following Avago Technologies recommendations.
- Passes IEC-61000-4-2 Electrostatic Discharge Immunity Test (ESD) and provides sufficient ESD creepage/clearance distance to withstand up to 12 kV discharge when assembled into a mouse with ADNS-6180-001 trim lens and up to 15 kV discharge when assembled into a mouse with ADNS-6180-002 wide trim lens.
- Passes IEC/EN 60825-1 Class-1 Eye Safety when ADNS-7700 is driving the laser using ADNS-6180-001 or ADNS-6180-002 lens with recommended operating conditions.

## Block Diagram

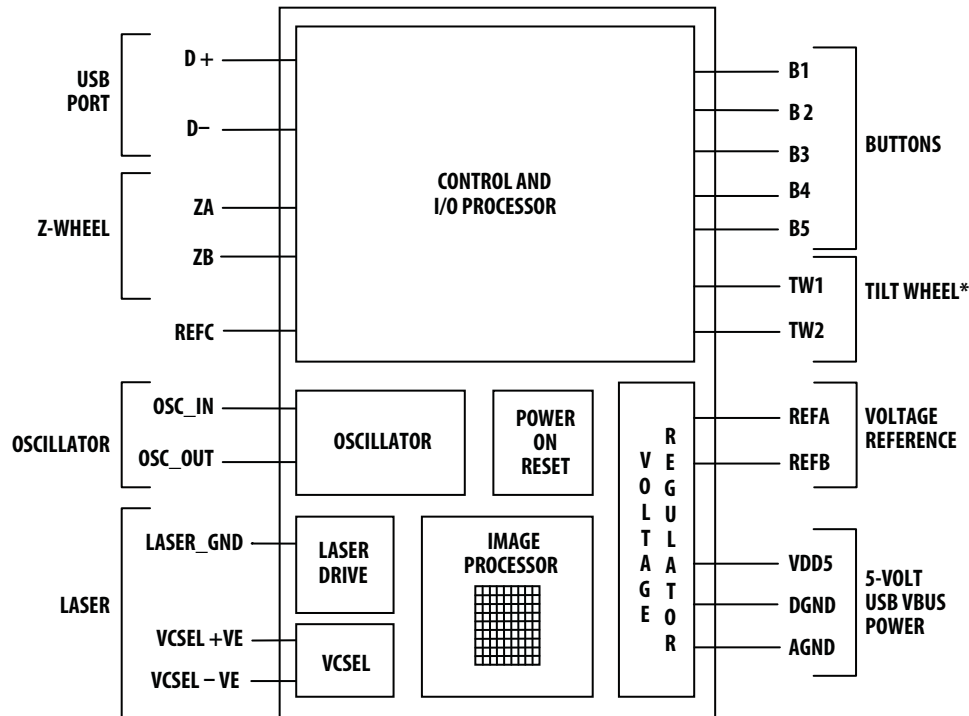

Figure 7. ADNS-7700 Block Diagram

## Eye Safety

ADNS-7700 sensor and the associated components in the schematic of Figure 6 are intended to comply with Class 1 Eye Safety requirements of IEC/EN 60825-1. Avago Technologies calibrate sensor laser output power (LOP) to Class 1 eye safety level prior shipping out, thus no laser output power calibration is required at mouse manufacturer site.

ADNS-7700 sensor is designed to maintain the laser output power using ADNS-6180-002 lens within Class 1 requirements over components manufacturing tolerances under the recommended operating conditions and application circuit of Figure 6 as specified in this document. Under normal operating conditions, the sensor generates the drive current for the VCSEL. Increasing the LOP by other means on hardware and software can result in a violation of the Class 1 eye safety limit of  $716 \mu\text{W}$ . For more information, please refer to Eye Safety Application Note.

## Laser Output Power

The laser output power, LOP can be measured at the navigation surface plane. The sensor can drive the laser in continuous (CW) mode by writing to LSR\_CTRL0 and LSR\_CTRL1 registers via USB Set Vendor test command.

The pre-calibrated LOP value at typical operating supply voltage and temperature of  $25 \pm 5^\circ\text{C}$  should not exceed-

ing  $506 \mu\text{W}$ , otherwise the  $\text{LOP}_{\text{max}}$  limit in the Absolute Maximum Rating is applicable.

The following conditions apply:

1. The system is operated based on the recommended application circuit in Figure 6 and within the recommended operating conditions.
2. Measurement is taken at the optical center and illumination angle on navigation surface plane, Z.
3. No allowance for optical power meter accuracy is assumed.

## Single Fault Detection

ADNS-7700 sensor is able to detect a short circuit or fault condition at the -VCSEL pin, which could lead to excessive laser power output. A path to ground on this pin will trigger the fault detection circuit, which will turn off the laser drive current source and set the LASER\_NEN output high. The system will prevent excess laser power for a resistive path to ground at -VCSEL by shutting off the laser. In addition to the ground path fault detection described above, the fault detection circuit is continuously checking for proper operation by internally generating a path to ground with the laser turned off via LASER\_NEN. If the -VCSEL pin is shorted internally to VDD3 or externally to REFB, this test will fail and will be reported as a fault.

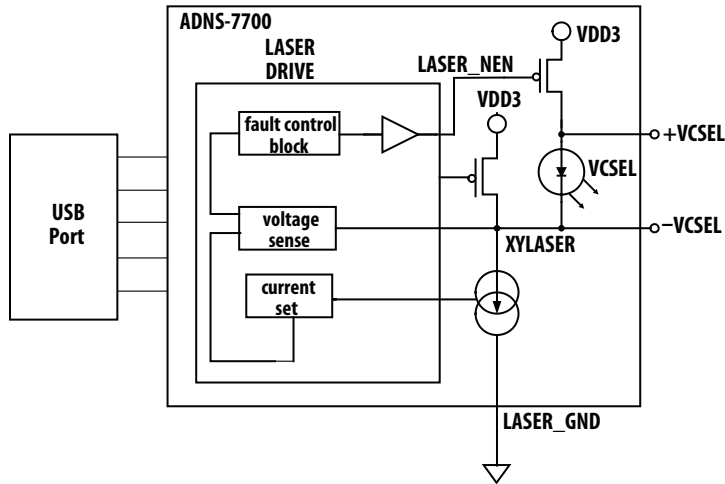

Figure 8. Single Fault Detection and Eye Safety Feature Block Diagram

### Absolute Maximum Ratings

Parameter	Symbol	Minimum	Maximum	Units	Notes
Storage Temperature	$T_S$	-40	85	°C	
Lead Solder Temperature			260	°C	For 7 seconds, 1.6mm below seating plane. Refer to soldering reflow profile in PCB Assembly & Soldering Considerations Application Note AN 5023.
Supply Voltage	$V_{DD}$	-0.5	5.5	V	
ESD			2	kV	All pins, human body model
Input Voltage	$V_{IN}$	-0.5	$V_{DD}+0.5$	V	All I/O pins except OSC_IN and OSC_OUT, D+, D-
Input Voltage	$V_{IN}$	-1.0	4.6	V	D+, D-, AC waveform, see USB specification (7.1.1)
Input Voltage	$V_{IN}$	-0.5	3.6	V	OSC_IN and OSC_OUT
Input Short Circuit Voltage	$V_{SC}$	0	$V_{DD}$	V	D+, D-, see USB specification (7.1.1)
Laser Output Power	$LOP_{max}$		716	μW	Class 1 eye safety AEL with ADNS-6180-001 or ADNS-6180-002 lens

#### Comments:

1. Stress greater than those listed under "Absolute Maximum Ratings" may cause permanent damage to the device. These are the stress ratings only and functional operation of the device at these or any other condition beyond those indicated for extended period of time may affect device reliability.
2. The inherent design of this component causes it to be sensitive to electrostatic discharge. The ESD threshold is listed above. To prevent ESD-induced damage, take adequate ESD precautions when handling this product.

## Recommended Operating Conditions

Parameter	Symbol	Minimum	Typical	Maximum	Units	Notes
Operating Temperature	$T_A$	0		40	°C	
Power Supply Voltage	$V_{DD}$	4.4	5.0	5.25	Volts	For accurate navigation and proper USB operation
Power Supply Rise Time	$V_{RT}$	0.1		100	ms	
Power Supply Noise	$V_N$			100	mVp-p	Peak to peak within 50kHz-100MHz bandwidth
Velocity	$V_{el}$		45		ips	
Acceleration	$Acc$			20	g	In Run Mode only
Clock Frequency	$f_{clk}$	23.64	24.00	24.36	MHz	Due to USB timing constraints
Resonator Impedance	$X_{RES}$			55	$\Omega$	
Distance from lens reference plane to surface	$Z$	2.18	2.40	2.62	mm	See Figure 9
Frame Rate			8000		fps	Internally adjusted by sensor
VCSEL's Peak Wavelength	$\lambda$	832		865	nm	

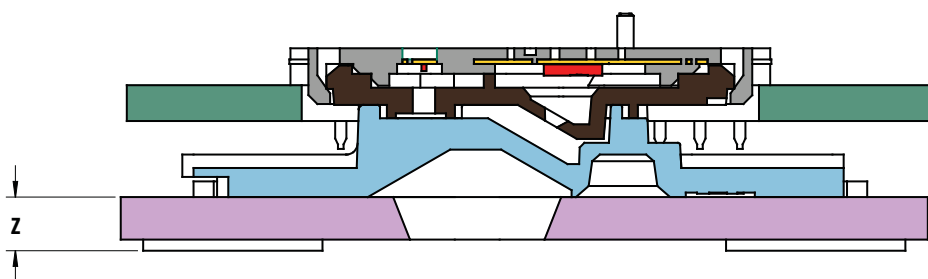

Figure 9. Distance from lens reference plane to object surface, Z

## AC Electrical Specifications

Electrical Characteristics over recommended operating conditions. Typical values at 25°C,  $V_{DD}=5.0$  V.

Parameter	Symbol	Min.	Typical	Max.	Units	Notes
Wakeup delay from rest mode due to motion	$T_{WUPP}$			2	ms	
Power up delay	$T_{PUP}$			50	ms	Delay measured from $V_{BUS}=4.4V$
Debounce delay on button inputs	$T_{DBB}$		6	9	ms	
Z-Wheel sampling period	$T_{SW}$	1.9	2.0	2.8	ms	ZA & ZB Pins
Transient Supply Current	$I_{DDT}$			75	mA	Max supply current during a $V_{DD}$ ramp from 0 to 5.0 V with $> 500\mu s$ rise time. Does not include charging currents for bypass capacitors.

## DC Electrical Specifications

Electrical Characteristics over recommended operating conditions. Typical values at 25°C, V<sub>DD</sub>=5.0 V,

Parameter	Symbol	Minimum	Typical	Maximum	Units	Notes
Run Mode System Current (Mouse moving)	I <sub>DD5</sub>			100	mA	Includes laser current on
Rest Mode System Current (Mouse not moving)	I <sub>DD5N</sub>			100	mA	Includes laser current
USB Suspend Mode System Current (Remote Wakeup Enabled)	I <sub>DD5S</sub>			500	μA	Includes D- pullup resistor
Input Low Voltage	V <sub>IL</sub>			0.5	V	Pins: ZA, ZB
				0.2*V <sub>REFB</sub>	V	Pins: B1-B5, TW1, TW2
Input High Voltage	V <sub>IH</sub>	0.6*V <sub>DD</sub>			V	Pins: ZA, ZB
		0.8* V <sub>REFB</sub>			V	Pins: B1-B5, TW1, TW2
Input Hysteresis	V <sub>HYST</sub>		230		mV	Pins: B1-B5, TW1, TW2
Button Pull Up Current	B <sub>IOUT</sub>	100	300	500	μA	Pins: B1-B5, TW1, TW2
Regulator output, REFA	V <sub>REFA</sub>	1.55	1.8	2.05	V	Typical operation current load
Regulator output, REFB	V <sub>REFB</sub>	3.0	3.3	3.6	V	Typical operation current load

## USB Electrical Specifications

Electrical Characteristics over recommended operating conditions.

Parameter	Symbol	Minimum	Maximum	Units	Notes
Output Signal Crossover Voltage	V <sub>CRS</sub>	1.5	2.0	V	C <sub>L</sub> = 200 to 600 pF (see Figure 10)
Input Signal Crossover Voltage	V <sub>ICRS</sub>	1.2	2.1	V	C <sub>L</sub> = 200 to 600 pF (see Figure 10)
Output High	V <sub>OH</sub>	2.8	3.6	V	with 15kΩ to Ground and 1.5kΩ to V <sub>REFB</sub> on D- (see Figure 10)
Output Low	V <sub>OL</sub>	0.0	0.3	V	with 15kΩ to Ground and 1.5kΩ to V <sub>REFB</sub> on D- (see Figure 10)
Single Ended Output	V <sub>SE0</sub>		0.8	V	
Input High (Driven)	V <sub>IH</sub>	2.0		V	
Input High (Floating)	V <sub>IHZ</sub>	2.7	3.6	V	
Input Low	V <sub>IL</sub>		0.8	V	1.5kΩ to V <sub>REFB</sub> on D-
Differential Input Sensitivity	V <sub>DI</sub>	0.2		V	{(D+)-(D-)}  See Figure 12
Differential Input Common Mode Range	V <sub>CM</sub>	0.8	2.5	V	Includes V <sub>DI</sub> , See Figure 12
Single Ended Receiver Threshold	V <sub>SE</sub>	0.8	2.0	V	
Transceiver Input Capacitance	C <sub>IN</sub>		12	pF	D+ to V <sub>BUS</sub> , D- to V <sub>BUS</sub>

## USB Timing Specifications

Timing Specifications over recommended operating conditions.

Parameter	Symbol	Minimum	Maximum	Units	Notes
D+/D- Transition rise time	$T_{LR}$	75		ns	$C_L = 200$ pF (10% to 90%), see Figure 10
D+/D- Transition rise time	$T_{LR}$		300	ns	$C_L = 600$ pF (10% to 90%), see Figure 10
D+/D- Transition fall time	$T_{LF}$	75		ns	$C_L = 200$ pF (90% to 10%), see Figure 10
D+/D- Transition fall time	$T_{LF}$		300	ns	$C_L = 600$ pF (90% to 10%), see Figure 10
Rise and Fall time matching	$T_{LRFM}$	80	125	%	$T_R/T_F$ ; $C_L = 200$ pF; Excluding the first transition from the Idle State
Wakeup delay from USB suspend mode due to buttons push	$T_{WUPB}$		17	ms	Delay from button push to USB operation Only required if remote wakeup enabled
Wakeup delay from USB suspend mode due to buttons push until accurate navigation	$T_{WUPN}$		50	ms	Delay from button push to navigation operation Only required if remote wakeup enabled
USB reset time	$T_{reset}$	18.7		$\mu$ s	
Data Rate	$t_{LDRATE}$	1.4775	1.5225	Mb/s	Average bit rate, 1.5 Mb/s +/- 1.5%
Receiver Jitter Tolerance	$t_{DJR1}$	-75	75	ns	To next transition, see Figure 13
Receiver Jitter Tolerance	$t_{DJR2}$	-45	45	ns	For paired transitions, see Figure 13
Differential to EOP Transition Skew	$t_{LDEOP}$	-40	100	ns	See Figure 14
EOP Width at Receiver	$t_{LEOPR}$	670		ns	Accepts EOP, see Figure 14
Source EOP Width	$t_{LEOPT}$	1.25	1.50	$\mu$ s	
Width of SE0 interval during Differential Transition	$t_{LST}$		210	ns	See Figure 11.
Differential Output Jitter	$t_{UDJ1}$	-95	95	ns	To next transition, see Figure 15
Differential Output Jitter	$t_{UDJ2}$	-150	150	ns	For paired transitions, see Figure 15

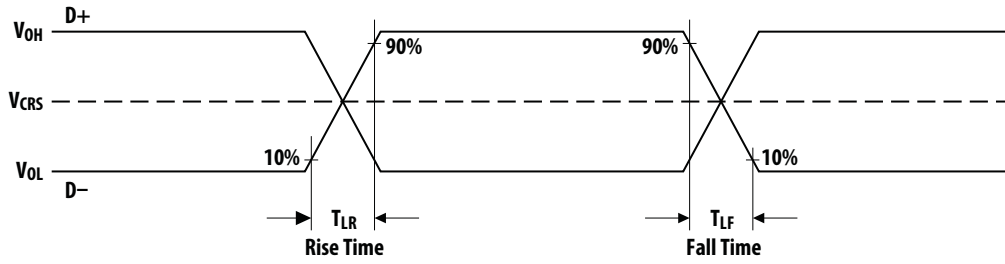

Figure 10. Data Signal Rise and Fall Times

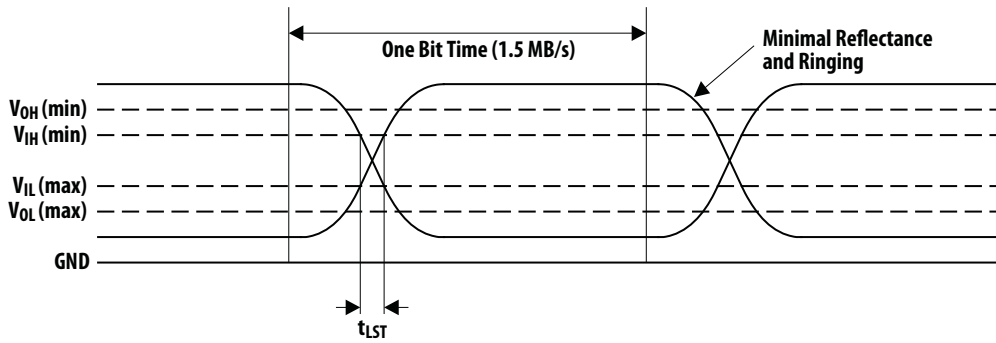

Figure 11. Data Signal Voltage Levels

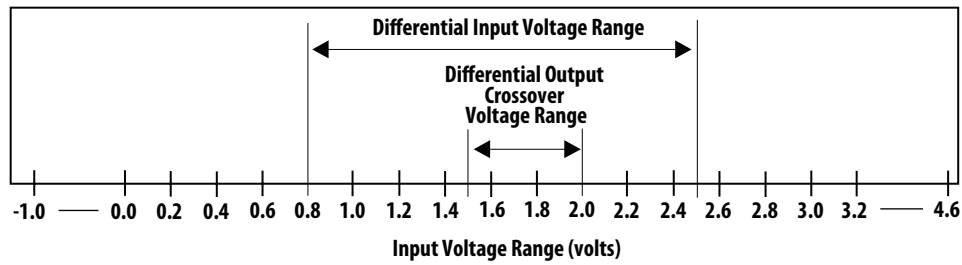

Figure 12. Differential Receiver Input Sensitivity vs. Common Mode Input Range

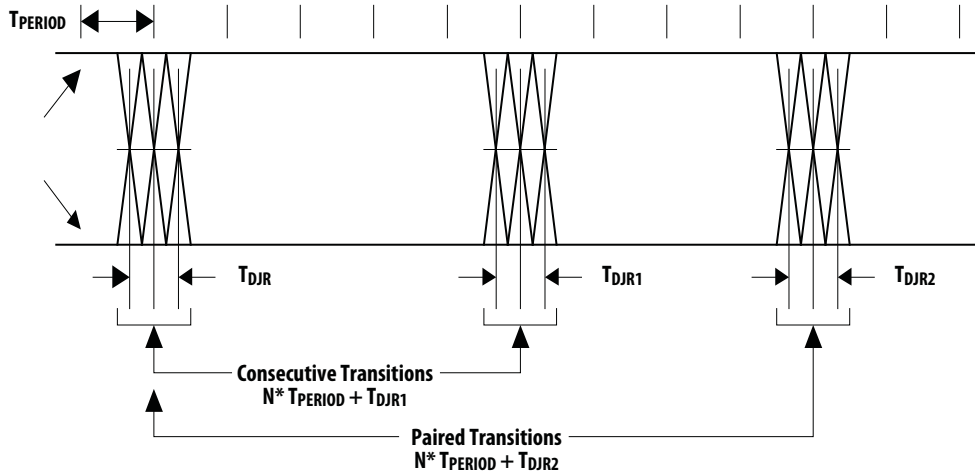

Figure 13. Receiver Jitter Tolerance

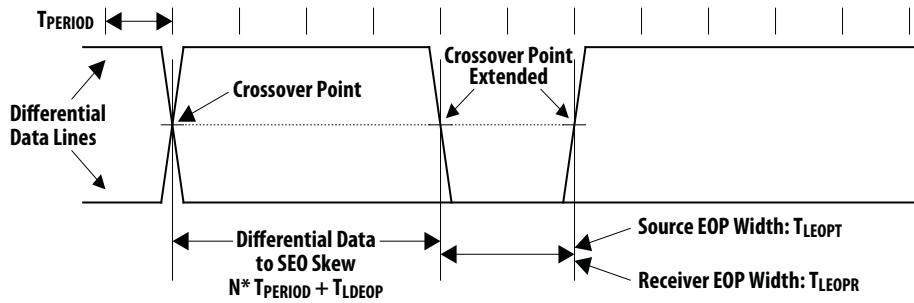

Figure 14. Differential to EOP Transition Skew and EOP Width

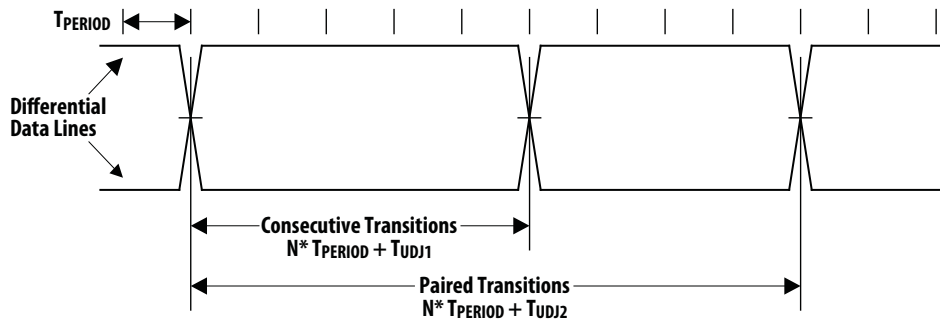

Figure 15. Differential Output Jitter



## One-Time-Programmable (OTP) Memory

The on chip OTP memory allows device configuration flexibility to override the default setting of ADNS-7700 sensors without any external software driver. Once the OTP operation is enabled, all OTP registers must be programmed accordingly as the default values of un-program OTP registers are always zero when L2\_USE\_OTP register setting is not zero value. Tips: OTP write to the OTP register can be skipped if the setting is zero value (0x00) in order to save the OTP programming time.

OTP address space is from 0x80 to 0xFE. OTP can be programmed via USB interface using Set Vendor Test and Get Vendor Test commands.

## OTP Byte Write Operation

OTP write operation flow chart is shown in Figure 16.

1. Set OTP enable bit in OTP\_CONFIG register, 0x4C: OTP\_EN = 1.
2. Write the OTP register address byte to OTP\_ADDR register, 0x4D.
3. Write the OTP data byte to OTP\_DATA register, 0x4E.
4. Set write enable bit in OTP\_CTRL register, 0x4F to enable write command to OTP: WR = 1.
5. Read the write enable bit status in OTP\_CTRL register, 0x4F. If WR = 1, repeat reading the bit status until it is clear.
6. Read the write status bit in OTP\_CTRLSTAT register, 0x50.
  - a. If WR\_OK = 1, OTP write operation is completed. Repeat Step 2 for more OTP byte write operations.
  - b. If WR\_OK = 0, repeat Step 4.
7. If Step 6b is repeated up to 10 times, OTP write operation is failed and the chip is confirmed as defective unit.

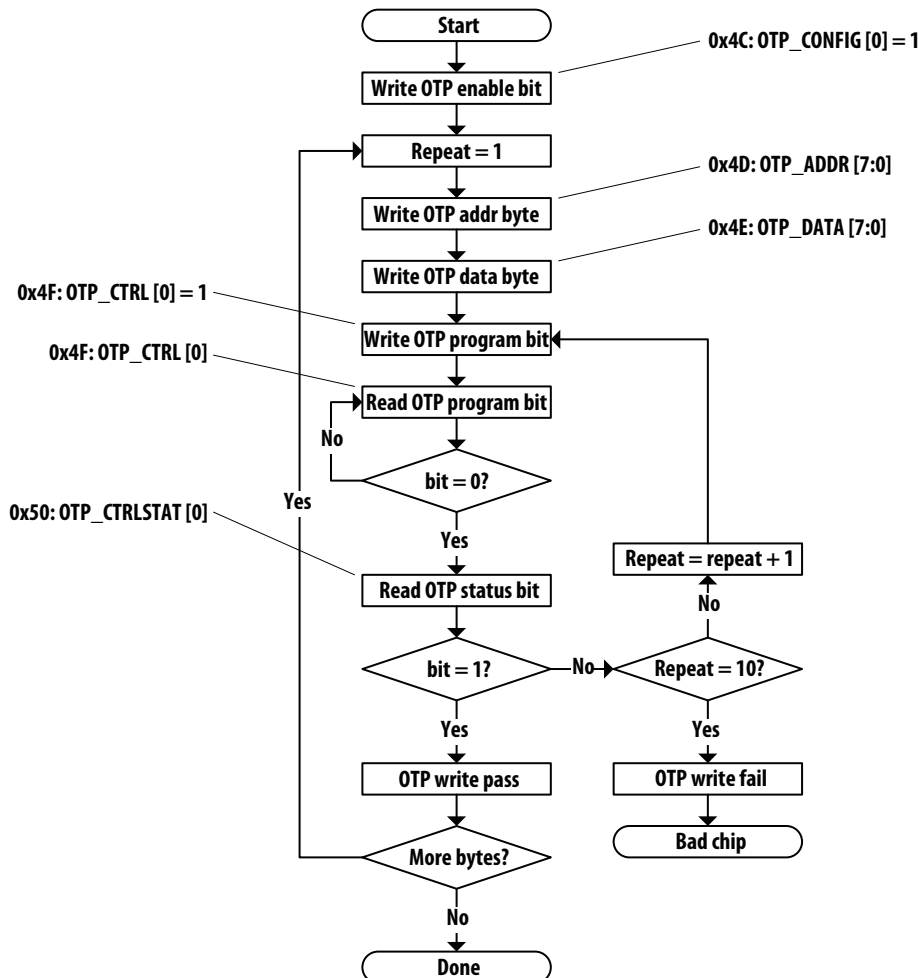

Figure 16. OTP Byte Write Flow Chart

## OTP Byte Read Operation

OTP read operation flow chart is shown in Figure 17.

1. Set OTP enable bit in OTP\_CONFIG register, 0x4C: OTP\_EN = 1.
2. Write the OTP register address byte to OTP\_ADDR register, 0x4D.
3. Set read enable bit in OTP\_CTRL register, 0x4F to enable write command to OTP: RD = 1.
4. Read the read enable bit status in OTP\_CTRL register, 0x4F. If RD = 1, repeat reading the bit status until it is clear.
5. Read the OTP data byte from OTP\_DATA register, 0x4E to complete the OTP read operation.
6. Repeat Step 2 for more OTP read operations.

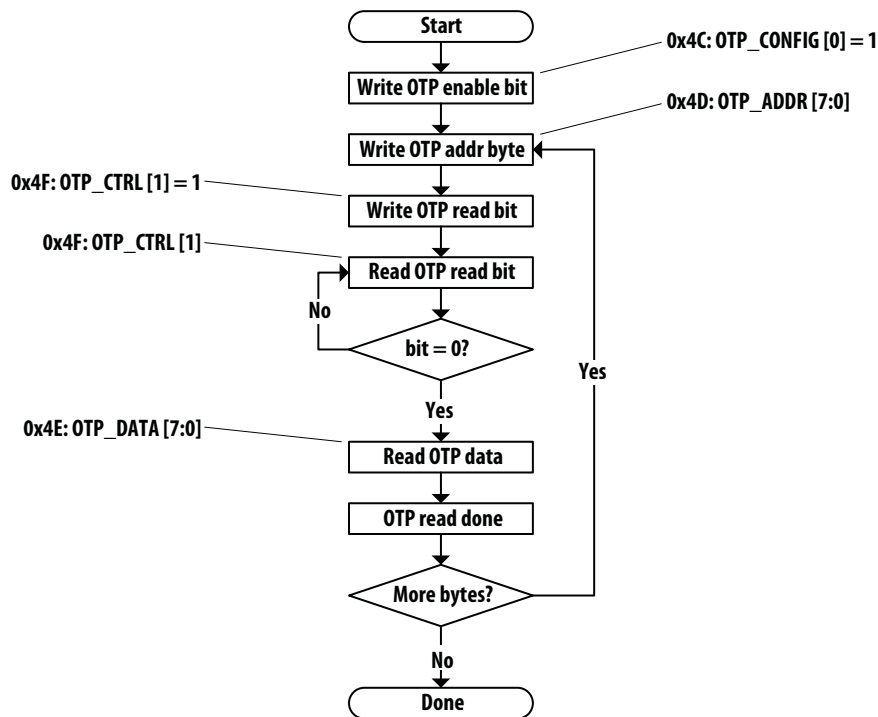

Figure 17. OTP Byte Read Flow Chart

## OTP Lock Operation

OTP lock operation MUST be performed once OTP write to OTPLOCK2 register for the sensor to function. DO not reset or power up the chip right after OTP write to OTPLOCK2 register, otherwise the chip will be malfunction. The OTP lock operation flow chart is shown in Figure 18.

1. After OTP write to OTPLOCK2 register, set OTP enable bit in OTP\_CONFIG register, 0x4C: OTP\_EN = 1.
2. Set OTP lock bit in OTP\_CTRL register, 0x4F to enable OTP lock command: LOCK\_L2 = 1.

3. Read the OTP lock bit status in OTP\_CTRL register, 0x4F. If LOCK\_L2 = 1, repeat reading the bit status until it is clear.
4. Read the lock status and CRC bits in OTP\_CTRLSTAT register, 0x50.
  - a. If both L2\_LOCK\_OK and L2\_CRC\_OK = 1, OTP lock operation is completed.
  - b. If either L2\_LOCK\_OK or L2\_CRC\_OK = 0, repeat Step 2 until both bits are set.
5. If Step 4b is repeated up to 10 times, OTP lock operation is failed and the chip is confirmed as defective unit.

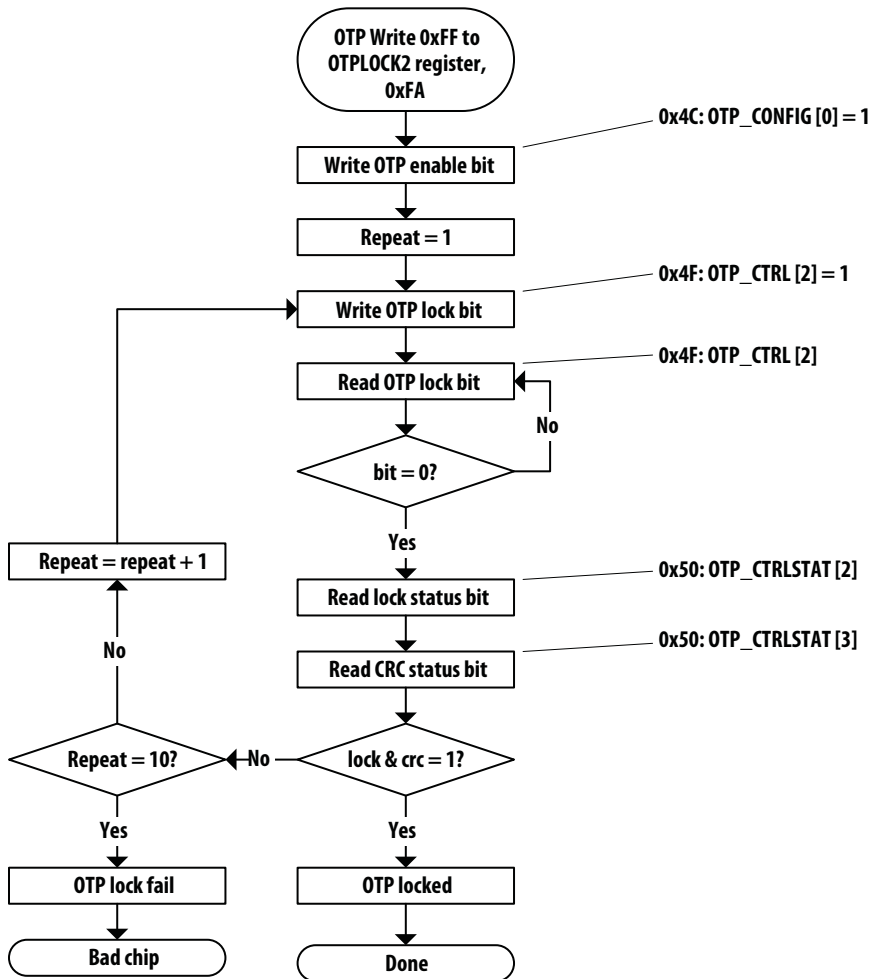

Figure 18. OTP Byte Lock Flow Chart

## Buttons and Tilt Wheel

The minimum time between button presses is  $T_{DBB}$ . Buttons, B1 through B5 and Tilt Wheel are connected to a Schmidt trigger input with  $100\mu\text{A}$  current sources pulling up to +5.0V during run, rest and USB suspend modes.

The tilt wheel feature can be enabled or disabled via OTP register. **All designers and manufacturers of final product with tilt wheel enabled must assure that they have all necessary intellectual property rights.**

## Debounce Algorithm

- Button inputs B1, B2, B3, B4, B5, TW1 and TW2 are sampled every 2ms.
- Three consecutive low values create a button press event.
- Three consecutive high values create a button release event.

## Z-Wheel

ADNS-7700 is designed to be used with mechanical Z-Wheel for vertical scrolling. The Z-Wheel reporting format which determines the vertical scroll resolution is Z/2 as most of the commonly available mechanical Z-Wheel encoders come with lower sensitivity.

## On-the-Fly (OTF) Resolution Mode

The ADNS-7700-HAMY, ADNS-7700-HCMY and ADNS-7700-HMMY sensors are enhanced with programmable On-the-Fly (OTF) resolution mode, which user is able to switch resolution setting anytime with OTF button click. OTF mode can be activated from OTP register 0xC1 by writing either 01 or 10 to OTF [1:0]. When OTF [1:0] = 00 or 11, the resolution setting is fixed as per CPI\_SET0 register configuration. Refer to Table 4 on the configurable options.

Every OTF button click triggers the change of resolution setting from current state to next state. The OTF state machine as shown in Figure 19 implements in the sequence of S0: CPI\_SET0, S1: CPI\_SET1 and S2: CPI\_SET2 in a cycle. The default state upon ADNS-7700 sensor power up is always at S0.

For ADNS-7700-HAMY sensor, the OTF state can be displayed with LED indication via LED0, LED1 and LED2 pins. LED0, LED1 and LED2 are active high output and can be connected to the base of a NPN bi-polar junction transistor (BJT) which when ON connects VDD to the LED.

The button click for OTF mode in ADNS-7700-HMMY requires long press. The long press timing is configurable via LONGPRESS register, 0xC6 with default timing of 0.256s.

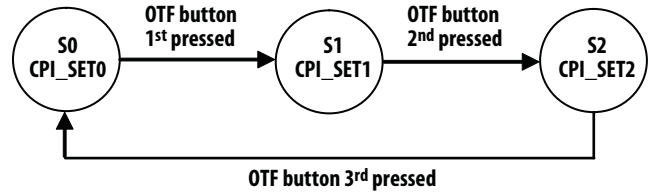

Figure 19. OTF Resolution Mode State Machine

Table 3. OTF LED Indication Status for ADNS-7700-HAMY

State Sequence		Current State Status		
Previous	Current	LED0	LED1	LED2
S2	S0	High	Low	Low
S0	S1	Low	High	Low
S1	S2	Low	Low	High

## KeyMap (KM)

KeyMap mode enables B4, B5, TW1 or TW2 button to be assigned as keyboard shortcut key. Thus, the sensor can be customized to implement standard Microsoft keyboard shortcut keys or special shortcut keys used in different applications, eg. Office, CAD, PC Games, etc. Table 3 shows the configuration of KM1 and KM2 pins in KeyMap mode. KM [1:0] bits in DEVCONFIG register, 0xC1 must complement to each other in order to enable KeyMap modes.

KM1 will be implemented as per CodeA setting while KM2 will be implemented as per CodeB setting. CodeA and Code B allow configuration of two and above keys combination (eg. Alt+Tab, Alt+Ctrl+Del).

CodeA = CODEA\_KEY1 register, 0xC2 + CODEA\_KEY2 register, 0xC4

CodeB = CODEB\_KEY1 register, 0xC3 + CODEB\_KEY2 register, 0xC5

CODEA\_KEY1 and CODEB\_KEY1 registers consist of 8 predefined keyboard keys: Microsoft Logo GUI, Alt, Shift and Ctrl keys located at left and right sides. CODEA\_KEY2 and CODEB\_KEY2 registers can be programmed with a keyboard key scan code available from Windows Platform Design Notes on Keyboard Scan Code Specification, which can be downloaded from:

<http://www.microsoft.com/whdc/archive/scancode.msp>

**Table 4. Resolution and KeyMap Mode OTP Configurations**

Part Number	Configuration Options	REG 0xC7	REG 0xC1	REG 0xC1	Pinout Configurations						
		TW_NEN	OTF1-0	KM1-0	B1	B2	B3	B4	B5	TW1	TW2
ADNS-7700-H4MY	3B	1	00	00	Left	Right	Middle	NA	NA	NA	NA
	<b>3B + TW (Default)</b>	<b>0</b>	<b>00</b>	<b>00</b>	<b>Left</b>	<b>Right</b>	<b>Middle</b>	<b>NA</b>	<b>NA</b>	<b>Tilt left</b>	<b>Tilt right</b>
ADNS-7700-HAMY	3B	1	00	00	Left	Right	Middle	NA	NA	NA	NA
	<b>3B + TW (Default)</b>	<b>0</b>	<b>00</b>	<b>00</b>	<b>Left</b>	<b>Right</b>	<b>Middle</b>	<b>NA</b>	<b>NA</b>	<b>Tilt left</b>	<b>Tilt right</b>
	3B + TW + OTF	0	01	00	Left	Right	Middle	NA	OTF	Tilt left	Tilt right
	3B + OTF + 3LED	1	01	00	Left	Right	Middle	LED2	OTF	LED1	LED0
ADNS-7700-HCMY	5B	1	00	00	Left	Right	Middle	Back	Forward	NA	NA
	<b>5B + TW (Default)</b>	<b>0</b>	<b>00</b>	<b>00</b>	<b>Left</b>	<b>Right</b>	<b>Middle</b>	<b>Back</b>	<b>Forward</b>	<b>Tilt left</b>	<b>Tilt right</b>
	5B + OTF	1	01	00	Left	Right	Middle	Back	Forward	NA	OTF
	4B + TW + OTF	0	01	00	Left	Right	Middle	Back	OTF	Tilt left	Tilt right
ADNS-7700-HMMY	5B	1	00	00	Left	Right	Middle	Back	Forward	NC	NC
	<b>5B + TW (Default)</b>	<b>0</b>	<b>00</b>	<b>00</b>	<b>Left</b>	<b>Right</b>	<b>Middle</b>	<b>Back</b>	<b>Forward</b>	<b>Tilt left</b>	<b>Tilt right</b>
	5B + KM1/OTF_L	1	01	01	Left	Right	Middle	Back	Forward	NC	KM1/ OTF_L
	5B + KM1/OTF_L + KM2	1	01	10	Left	Right	Middle	Back	Forward	KM2	KM1/ OTF_L
	4B + TW + KM1/OTF_L	0	01	01	Left	Right	Middle	Back	KM1/ OTF_L	Tilt left	Tilt right
	3B + TW + KM1/OTF_L	0	10	01	Left	Right	Middle	NC	KM1/ OTF_L	Tilt left	Tilt right
	3B + TW + KM1/OTF_L + KM2	0	10	10	Left	Right	Middle	KM2	KM1/ OTF_L	Tilt left	Tilt right

**Configuration after Power Up (Data Values)**

Signal Function	State from Figure 9-1 of USB spec: Powered or Default Address or Configured	State from Figure 9-1 of USB spec: Suspended from any other states
B1	Pullup active for button use	Pullup active for button use
B2	Pullup active for button use	Pullup active for button use
B3	Pullup active for button use	Pullup active for button use
B4	Pullup active for button use	Pullup active for button use
B5	Pullup active for button use	Pullup active for button use
TW1	Pullup active for button use	Pullup active for button use
TW2	Pullup active for button use	Pullup active for button use
D+	USB I/O	Hi-Z input
D-	USB I/O	Hi-Z input
OSC_IN	24MHz	Drive Logic '1'
OSC_OUT	24MHz	Drive Logic '1'
-VCSEL	Pulsing	Pulled high (off)
ZA	Hi-Z input	Hi-Z input
ZB	Hi-Z input	Hi-Z input

## Typical Performance Characteristics

The following graphs are the typical performance of the ADNS-7700 sensor, assembled as shown in the 2D assembly drawing with the ADNS-6180-001 or ADNS-6180-002 lens.

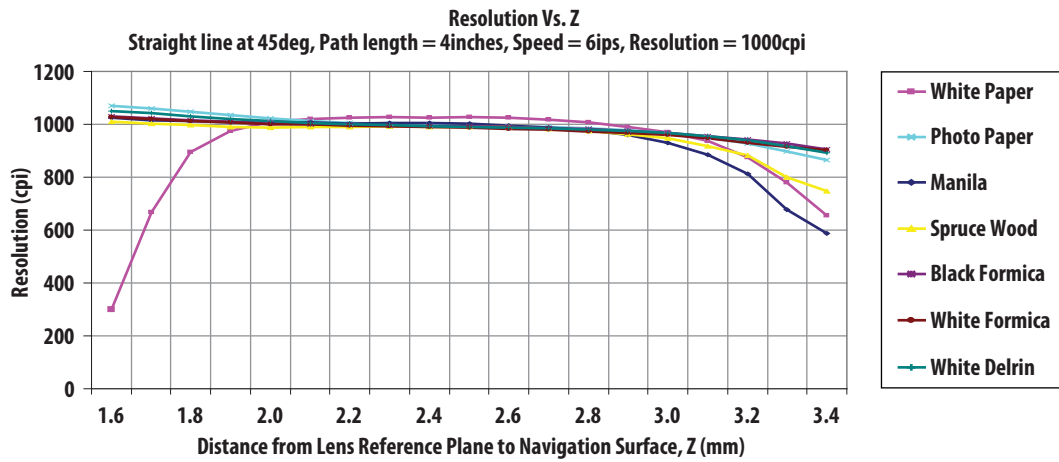

Figure 20. Mean Resolution vs. Z

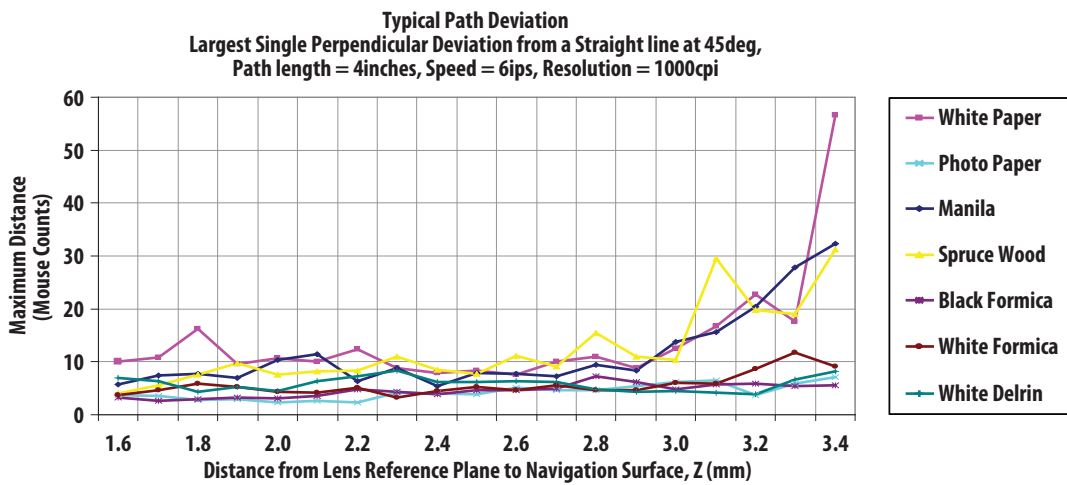

Figure 21. Average Error vs. Z

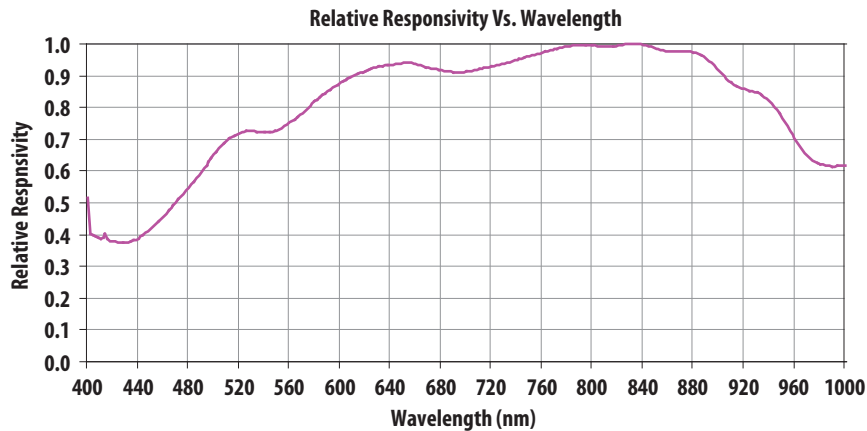

Figure 22. Wavelength Responsivity

## USB Commands

Mnemonic	Command	Notes
USB_RESET	D+/D- low > 18.7us	Device Resets; Address = 0
USB_SUSPEND	Idle state > 3mS	Device enters USB low-power mode
USB_RESUME	Non-idle state	Device exits USB low-power mode
Get_Status_Device	80 00 00 00 00 00 02 00	Normally returns 00 00, Self powered 00 00, Remote wakeup 02 00
Get_Status_Interface	81 00 00 00 00 00 02 00	Normally returns 00 00
Get_Status_Endpt0	82 00 00 00 xx 00 02 00	OUT: xx = 00, IN: xx = 80 Normally returns 00 00
Get_Status_Endpt1	82 00 00 00 81 00 02 00	Normally returns 00 00, Halt 00 01
Get_Configuration	80 08 00 00 00 00 01 00	Return: 00 = not config., 01 = configured
Get_Interface	81 0A 00 00 00 00 01 00	Normally returns 00
Get_Protocol	A1 03 00 00 00 00 01 00	Normally returns 01, Boot protocol 00
Get_Desc_Device	80 06 00 01 00 00 nn 00	See USB Command Details Application Note
Get_Desc_Config	80 06 00 02 00 00 nn 00	See USB Command Details Application Note
Get_Desc_String	80 06 xx 03 00 00 nn 00	See USB Command Details Application Note
Get_Desc_HID	81 06 00 21 00 00 09 00	See USB Command Details Application Note
Get_Desc_HID_Report	81 06 00 22 00 00 nn 00	See USB Command Details Application Note
Get_HID_Input	A1 01 00 01 00 00 nn 00	Return depends on motion & config
Get_Idle	A1 02 00 00 00 00 01 00	Returns rate in multiples of 4ms
Get_Vendor_Test	C0 01 00 00 xx 00 01 00	xx = address of register to read
Set_Address	00 05 xx 00 00 00 00 00	xx = address
Set_Configuration	00 09 xx 00 00 00 00 00	Not configured: xx = 00 Configured: xx = 01
Set_Interface	01 0B 00 00 00 00 00 00	Only one interface supported
Set_Protocol	21 0B xx 00 00 00 00 00	Boot: xx=00, Report: xx=01
Set_Feature_Device	00 03 01 00 00 00 00 00	Enable remote wakeup
Set_Feature_Endpt0	02 03 00 00 xx 00 00 00	Halt. OUT: xx = 00, IN: xx = 80
Set_Feature_Endpt1	02 03 00 00 81 00 00 00	Halt
Clear_Feature_Device	00 01 01 00 00 00 00 00	Disable Remote wakeup
Clear_Feature_Endpt0	02 01 00 00 xx 00 00 00	Clear Halt; OUT: xx = 00, IN: xx = 80
Clear_Feature_Endpt1	02 01 00 00 81 00 00 00	Clear Halt
Set_Idle	21 0A 00 rr 00 00 00 00	rr = report rate in multiples of 4ms
Set_Vendor_Test	40 01 00 00 xx yy 00 00	Write yy to address xx
Poll_Endpt1		Read buttons, motion, & Z-wheel

Note: The last two bytes in a command shown as "nn 00" specify the 16-bit data size in the order of "LowByte HighByte." For example a two-byte data size would be specified as "02 00." ADNS-7700 will not provide more bytes than the number requested in the command, but it will only supply up to a maximum of 8bytes at a time. The ADNS-7700 will re-send the last packet if the transfer is not acknowledged properly.

## USB Data Packet Format

<b>Sensor</b>	ADNS-7700-H4MY, ADNS-7700-HAMY							
<b>Configuration</b>	3B, 3B+OTF+3LED							
<b>Button</b>	3							
<b>Motion Format</b>	8-Bit							
<b>Z-Wheel</b>	Mechanical							
<b>Tilt-Wheel</b>	Disabled							
<b>OTF</b>	Disabled/ Enabled							
<b>KM</b>	Disabled/							
	<b>Bit 7</b>	<b>Bit 6</b>	<b>Bit 5</b>	<b>Bit 4</b>	<b>Bit 3</b>	<b>Bit 2</b>	<b>Bit 1</b>	<b>Bit 0</b>
<b>Byte 1</b>	0	0	0	0	0	MB	RB	LB
<b>Byte 2</b>	X[7]	X[6]	X[5]	X[4]	X[3]	X[2]	X[1]	X[0]
<b>Byte 3</b>	Y[7]	Y[6]	Y[5]	Y[4]	Y[3]	Y[2]	Y[1]	Y[0]
<b>Byte 4</b>	Z[7]	Z[6]	Z[5]	Z[4]	Z[3]	Z[2]	Z[1]	Z[0]

<b>Sensor</b>	ADNS-7700-H4MY, ADNS-7700-HAMY							
<b>Configuration</b>	3B+TW, 3B+TW+OTF							
<b>Button</b>	3							
<b>Motion Format</b>	8-Bit							
<b>Z-Wheel</b>	Mechanical							
<b>Tilt-Wheel</b>	Enabled							
<b>OTF</b>	Disabled/ Enabled							
<b>KM</b>	Disabled							
	<b>Bit 7</b>	<b>Bit 6</b>	<b>Bit 5</b>	<b>Bit 4</b>	<b>Bit 3</b>	<b>Bit 2</b>	<b>Bit 1</b>	<b>Bit 0</b>
<b>Byte 1</b>	0	0	0	0	0	MB	RB	LB
<b>Byte 2</b>	X[7]	X[6]	X[5]	X[4]	X[3]	X[2]	X[1]	X[0]
<b>Byte 3</b>	Y[7]	Y[6]	Y[5]	Y[4]	Y[3]	Y[2]	Y[1]	Y[0]
<b>Byte 4</b>	Z[7]	Z[6]	Z[5]	Z[4]	Z[3]	Z[2]	Z[1]	Z[0]
<b>Byte 5</b>	TW[7]	TW[6]	TW[5]	TW[4]	TW[3]	TW[2]	TW[1]	TW[0]



<b>Sensor</b>	ADNS-7700-HCMY, ADNS-7700-HMMY							
<b>Configuration</b>	5B, 5B+OTF							
<b>Button</b>	5							
<b>Motion Format</b>	8-Bit							
<b>Z-Wheel</b>	Mechanical							
<b>Tilt-Wheel</b>	Disabled							
<b>OTF</b>	Disabled/Enabled							
<b>KM</b>	Disabled							
	<b>Bit 7</b>	<b>Bit 6</b>	<b>Bit 5</b>	<b>Bit 4</b>	<b>Bit 3</b>	<b>Bit 2</b>	<b>Bit 1</b>	<b>Bit 0</b>
<b>Byte 1</b>	0	0	0	FB	BB	MB	RB	LB
<b>Byte 2</b>	X[7]	X[6]	X[5]	X[4]	X[3]	X[2]	X[1]	X[0]
<b>Byte 3</b>	Y[7]	Y[6]	Y[5]	Y[4]	Y[3]	Y[2]	Y[1]	Y[0]
<b>Byte 4</b>	Z[7]	Z[6]	Z[5]	Z[4]	Z[3]	Z[2]	Z[1]	Z[0]

<b>Sensor</b>	ADNS-7700-HCMY							
<b>Configuration</b>	5B+TW							
<b>Button</b>	5							
<b>Motion Format</b>	8-Bit							
<b>Z-Wheel</b>	Mechanical							
<b>Tilt-Wheel</b>	Enabled							
<b>OTF</b>	Disabled							
<b>KM</b>	Disabled							
	<b>Bit 7</b>	<b>Bit 6</b>	<b>Bit 5</b>	<b>Bit 4</b>	<b>Bit 3</b>	<b>Bit 2</b>	<b>Bit 1</b>	<b>Bit 0</b>
<b>Byte 1</b>	0	0	0	FB	BB	MB	RB	LB
<b>Byte 2</b>	X[7]	X[6]	X[5]	X[4]	X[3]	X[2]	X[1]	X[0]
<b>Byte 3</b>	Y[7]	Y[6]	Y[5]	Y[4]	Y[3]	Y[2]	Y[1]	Y[0]
<b>Byte 4</b>	Z[7]	Z[6]	Z[5]	Z[4]	Z[3]	Z[2]	Z[1]	Z[0]
<b>Byte 5</b>	TW[7]	TW[6]	TW[5]	TW[4]	TW[3]	TW[2]	TW[1]	TW[0]

<b>Sensor</b>	ADNS-7700-HCMY
<b>Configuration</b>	4B+TW+OTF
<b>Button</b>	5
<b>Motion Format</b>	8-Bit
<b>Z-Wheel</b>	Mechanical
<b>Tilt-Wheel</b>	Enabled
<b>OTF</b>	Enabled
<b>KM</b>	Disabled

	<b>Bit 7</b>	<b>Bit 6</b>	<b>Bit 5</b>	<b>Bit 4</b>	<b>Bit 3</b>	<b>Bit 2</b>	<b>Bit 1</b>	<b>Bit 0</b>
<b>Byte 1</b>	0	0	0	0	BB	MB	RB	LB
<b>Byte 2</b>	X[7]	X[6]	X[5]	X[4]	X[3]	X[2]	X[1]	X[0]
<b>Byte 3</b>	Y[7]	Y[6]	Y[5]	Y[4]	Y[3]	Y[2]	Y[1]	Y[0]
<b>Byte 4</b>	Z[7]	Z[6]	Z[5]	Z[4]	Z[3]	Z[2]	Z[1]	Z[0]
<b>Byte 5</b>	TW[7]	TW[6]	TW[5]	TW[4]	TW[3]	TW[2]	TW[1]	TW[0]

<b>Sensor</b>	ADNS-7700-HMMY
<b>Configuration</b>	5B+KM1/OTF_L, 5B+KM1/OTF_L+ KM2
<b>Button</b>	5
<b>Motion Format</b>	8-Bit
<b>Z-Wheel</b>	Mechanical
<b>Tilt-Wheel</b>	Disabled
<b>OTF</b>	Enabled
<b>KM</b>	Enabled

	<b>Bit 7</b>	<b>Bit 6</b>	<b>Bit 5</b>	<b>Bit 4</b>	<b>Bit 3</b>	<b>Bit 2</b>	<b>Bit 1</b>	<b>Bit 0</b>
<b>Byte 1</b>	REPORT ID (01)							
<b>Byte 2</b>	0	0	0	FB	BB	MB	RB	LB
<b>Byte 3</b>	X[7]	X[6]	X[5]	X[4]	X[3]	X[2]	X[1]	X[0]
<b>Byte 4</b>	Y[7]	Y[6]	Y[5]	Y[4]	Y[3]	Y[2]	Y[1]	Y[0]
<b>Byte 5</b>	Z[7]	Z[6]	Z[5]	Z[4]	Z[3]	Z[2]	Z[1]	Z[0]
<b>Byte 1</b>	REPORT ID (02)							
<b>Byte 2</b>	R-Gui	R-Alt	R-Shift	R-Ctrl	L-Gui	L-Alt	L-Shift	L-Ctrl
<b>Byte 3</b>	0	0	0	0	0	0	0	0
<b>Byte 4</b>	KEY_CODE_ A[7]	KEY_CODE_ A[6]	KEY_CODE_ A[5]	KEY_CODE_ A[4]	KEY_CODE_ A[3]	KEY_CODE_ A[2]	KEY_CODE_ A[1]	KEY_CODE_ A[0]
<b>Byte 5</b>	KEY_CODE_ B[7]	KEY_CODE_ B[6]	KEY_CODE_ B[5]	KEY_CODE_ B[4]	KEY_CODE_ B[3]	KEY_CODE_ B[2]	KEY_CODE_ B[1]	KEY_CODE_ B[0]

<b>Sensor</b>	ADNS-7700-HMMY							
<b>Configuration</b>	3B+TW+KM1/OTF_L, 3B+TW+KM1/OTF_L+ KM2							
<b>Button</b>	5							
<b>Motion Format</b>	8-Bit							
<b>Z-Wheel</b>	Mechanical							
<b>Tilt-Wheel</b>	Enabled							
<b>OTF</b>	Enabled							
<b>KM</b>	Enabled							
	<b>Bit 7</b>	<b>Bit 6</b>	<b>Bit 5</b>	<b>Bit 4</b>	<b>Bit 3</b>	<b>Bit 2</b>	<b>Bit 1</b>	<b>Bit 0</b>
<b>Byte 1</b>	REPORT ID (01)							
<b>Byte 2</b>	0	0	0	0	0	MB	RB	LB
<b>Byte 3</b>	Y[7]	Y[6]	Y[5]	Y[4]	Y[3]	Y[2]	Y[1]	Y[0]
<b>Byte 4</b>	Y[7]	Y[6]	Y[5]	Y[4]	Y[3]	Y[2]	Y[1]	Y[0]
<b>Byte 5</b>	Z[7]	Z[6]	Z[5]	Z[4]	Z[3]	Z[2]	Z[1]	Z[0]
<b>Byte 6</b>	TW[7]	TW[6]	TW[5]	TW[4]	TW[3]	TW[2]	TW[1]	TW[0]
<b>Byte 1</b>	REPORT ID (02)							
<b>Byte 2</b>	R-Gui	R-Alt	R-Shift	R-Ctrl	L-Gui	L-Alt	L-Shift	L-Ctrl
<b>Byte 3</b>	0	0	0	0	0	0	0	0
<b>Byte 4</b>	KEY_CODE_ A[7]	KEY_CODE_ A[6]	KEY_CODE_ A[5]	KEY_CODE_ A[4]	KEY_CODE_ A[3]	KEY_CODE_ A[2]	KEY_CODE_ A[1]	KEY_CODE_ A[0]
<b>Byte 5</b>	KEY_CODE_ B[7]	KEY_CODE_ B[6]	KEY_CODE_ B[5]	KEY_CODE_ B[4]	KEY_CODE_ B[3]	KEY_CODE_ B[2]	KEY_CODE_ B[1]	KEY_CODE_ B[0]

<b>Sensor</b>	ADNS-7700-HMMY							
<b>Configuration</b>	4B+TW+KM1/OTF_L							
<b>Button</b>	5							
<b>Motion Format</b>	8-Bit							
<b>Z-Wheel</b>	Mechanical							
<b>Tilt-Wheel</b>	Enabled							
<b>OTF</b>	Enabled							
<b>KM</b>	Enabled							
	<b>Bit 7</b>	<b>Bit 6</b>	<b>Bit 5</b>	<b>Bit 4</b>	<b>Bit 3</b>	<b>Bit 2</b>	<b>Bit 1</b>	<b>Bit 0</b>
<b>Byte 1</b>	REPORT ID (01)							
<b>Byte 2</b>	0	0	0	0	BB	MB	RB	LB
<b>Byte 3</b>	X[7]	X[6]	X[5]	X[4]	X[3]	X[2]	X[1]	X[0]
<b>Byte 4</b>	Y[7]	Y[6]	Y[5]	Y[4]	Y[3]	Y[2]	Y[1]	Y[0]
<b>Byte 5</b>	Z[7]	Z[6]	Z[5]	Z[4]	Z[3]	Z[2]	Z[1]	Z[0]
<b>Byte 6</b>	TW[7]	TW[6]	TW[5]	TW[4]	TW[3]	TW[2]	TW[1]	TW[0]
<b>Byte 1</b>	REPORT ID (02)							
<b>Byte 2</b>	R-Gui	R-Alt	R-Shift	R-Ctrl	L-Gui	L-Alt	L-Shift	L-Ctrl
<b>Byte 3</b>	0	0	0	0	0	0	0	0
<b>Byte 4</b>	KEY_CODE_ A[7]	KEY_CODE_ A[6]	KEY_CODE_ A[5]	KEY_CODE_ A[4]	KEY_CODE_ A[3]	KEY_CODE_ A[2]	KEY_CODE_ A[1]	KEY_CODE_ A[0]

<b>Sensor</b>	ADNS-7700-H4MY, ADNS-7700-HAMY							
<b>Configuration</b>	3B, 3B+OTF+3LED							
<b>Button</b>	3							
<b>Motion Format</b>	12-Bit							
<b>Z-Wheel</b>	Mechanical							
<b>Tilt-Wheel</b>	Disabled							
<b>OTF</b>	Disabled/ Enabled							
<b>KM</b>	Disabled/							
	<b>Bit 7</b>	<b>Bit 6</b>	<b>Bit 5</b>	<b>Bit 4</b>	<b>Bit 3</b>	<b>Bit 2</b>	<b>Bit 1</b>	<b>Bit 0</b>
<b>Byte 1</b>	0	0	0	0	0	MB	RB	LB
<b>Byte 2</b>	X[7]	X[6]	X[5]	X[4]	X[3]	X[2]	X[1]	X[0]
<b>Byte 3</b>	Y[3]	Y[2]	Y[1]	Y[0]	X[11]	X[10]	X[9]	X[8]
<b>Byte 4</b>	Y[11]	Y[10]	Y[9]	Y[8]	Y[7]	Y[6]	Y[5]	Y[4]
<b>Byte 5</b>	Z[7]	Z[6]	Z[5]	Z[4]	Z[3]	Z[2]	Z[1]	Z[0]

<b>Sensor</b>	ADNS-7700-H4MY, ADNS-7700-HAMY							
<b>Configuration</b>	3B+TW, 3B+TW+OTF							
<b>Button</b>	3							
<b>Motion Format</b>	12-Bit							
<b>Z-Wheel</b>	Mechanical							
<b>Tilt-Wheel</b>	Enabled							
<b>OTF</b>	Disabled/ Enabled							
<b>KM</b>	Disabled							
	<b>Bit 7</b>	<b>Bit 6</b>	<b>Bit 5</b>	<b>Bit 4</b>	<b>Bit 3</b>	<b>Bit 2</b>	<b>Bit 1</b>	<b>Bit 0</b>
<b>Byte 1</b>	0	0	0	0	0	MB	RB	LB
<b>Byte 2</b>	X[7]	X[6]	X[5]	X[4]	X[3]	X[2]	X[1]	X[0]
<b>Byte 3</b>	Y[3]	Y[2]	Y[1]	Y[0]	X[11]	X[10]	X[9]	X[8]
<b>Byte 4</b>	Y[11]	Y[10]	Y[9]	Y[8]	Y[7]	Y[6]	Y[5]	Y[4]
<b>Byte 5</b>	Z[7]	Z[6]	Z[5]	Z[4]	Z[3]	Z[2]	Z[1]	Z[0]
<b>Byte 6</b>	TW[7]	TW[6]	TW[5]	TW[4]	TW[3]	TW[2]	TW[1]	TW[0]

<b>Sensor</b>	ADNS-7700-HCMY, ADNS-7700-HMMY							
<b>Configuration</b>	5B, 5B+OTF							
<b>Button</b>	5							
<b>Motion Format</b>	12-Bit							
<b>Z-Wheel</b>	Mechanical							
<b>Tilt-Wheel</b>	Disabled							
<b>OTF</b>	Disabled/Enabled							
<b>KM</b>	Disabled							
	<b>Bit 7</b>	<b>Bit 6</b>	<b>Bit 5</b>	<b>Bit 4</b>	<b>Bit 3</b>	<b>Bit 2</b>	<b>Bit 1</b>	<b>Bit 0</b>
<b>Byte 1</b>	0	0	0	FB	BB	MB	RB	LB
<b>Byte 2</b>	X[7]	X[6]	X[5]	X[4]	X[3]	X[2]	X[1]	X[0]
<b>Byte 3</b>	Y[3]	Y[2]	Y[1]	Y[0]	X[11]	X[10]	X[9]	X[8]
<b>Byte 4</b>	Y[11]	Y[10]	Y[9]	Y[8]	Y[7]	Y[6]	Y[5]	Y[4]
<b>Byte 5</b>	Z[7]	Z[6]	Z[5]	Z[4]	Z[3]	Z[2]	Z[1]	Z[0]

<b>Sensor</b>	ADNS-7700-HCMY							
<b>Configuration</b>	5B+TW							
<b>Button</b>	5							
<b>Motion Format</b>	12-Bit							
<b>Z-Wheel</b>	Mechanical							
<b>Tilt-Wheel</b>	Enabled							
<b>OTF</b>	Disabled							
<b>KM</b>	Disabled							
	<b>Bit 7</b>	<b>Bit 6</b>	<b>Bit 5</b>	<b>Bit 4</b>	<b>Bit 3</b>	<b>Bit 2</b>	<b>Bit 1</b>	<b>Bit 0</b>
<b>Byte 1</b>	0	0	0	FB	BB	MB	RB	LB
<b>Byte 2</b>	X[7]	X[6]	X[5]	X[4]	X[3]	X[2]	X[1]	X[0]
<b>Byte 3</b>	Y[3]	Y[2]	Y[1]	Y[0]	X[11]	X[10]	X[9]	X[8]
<b>Byte 4</b>	Y[11]	Y[10]	Y[9]	Y[8]	Y[7]	Y[6]	Y[5]	Y[4]
<b>Byte 5</b>	Z[7]	Z[6]	Z[5]	Z[4]	Z[3]	Z[2]	Z[1]	Z[0]
<b>Byte 6</b>	TW[7]	TW[6]	TW[5]	TW[4]	TW[3]	TW[2]	TW[1]	TW[0]

<b>Sensor</b>	ADNS-7700-HCMY							
<b>Configuration</b>	4B+TW+OTF							
<b>Button</b>	5							
<b>Motion Format</b>	12-Bit							
<b>Z-Wheel</b>	Mechanical							
<b>Tilt-Wheel</b>	Enabled							
<b>OTF</b>	Enabled							
<b>KM</b>	Disabled							
	<b>Bit 7</b>	<b>Bit 6</b>	<b>Bit 5</b>	<b>Bit 4</b>	<b>Bit 3</b>	<b>Bit 2</b>	<b>Bit 1</b>	<b>Bit 0</b>
<b>Byte 1</b>	0	0	0	0	BB	MB	RB	LB
<b>Byte 2</b>	X[7]	X[6]	X[5]	X[4]	X[3]	X[2]	X[1]	X[0]
<b>Byte 3</b>	Y[3]	Y[2]	Y[1]	Y[0]	X[11]	X[10]	X[9]	X[8]
<b>Byte 4</b>	Y[11]	Y[10]	Y[9]	Y[8]	Y[7]	Y[6]	Y[5]	Y[4]
<b>Byte 5</b>	Z[7]	Z[6]	Z[5]	Z[4]	Z[3]	Z[2]	Z[1]	Z[0]
<b>Byte 6</b>	TW[7]	TW[6]	TW[5]	TW[4]	TW[3]	TW[2]	TW[1]	TW[0]

<b>Sensor</b>	ADNS-7700-HMMY							
<b>Configuration</b>	5B+KM1/OTF_L, 5B+KM1/OTF_L+ KM2							
<b>Button</b>	5							
<b>Motion Format</b>	12-Bit							
<b>Z-Wheel</b>	Mechanical							
<b>Tilt-Wheel</b>	Disabled							
<b>OTF</b>	Enabled							
<b>KM</b>	Enabled							
	<b>Bit 7</b>	<b>Bit 6</b>	<b>Bit 5</b>	<b>Bit 4</b>	<b>Bit 3</b>	<b>Bit 2</b>	<b>Bit 1</b>	<b>Bit 0</b>
<b>Byte 1</b>	REPORT ID (01)							
<b>Byte 2</b>	0	0	0	FB	BB	MB	RB	LB
<b>Byte 3</b>	X[7]	X[6]	X[5]	X[4]	X[3]	X[2]	X[1]	X[0]
<b>Byte 4</b>	Y[3]	Y[2]	Y[1]	Y[0]	X[11]	X[10]	X[9]	X[8]
<b>Byte 5</b>	Y[11]	Y[10]	Y[9]	Y[8]	Y[7]	Y[6]	Y[5]	Y[4]
<b>Byte 6</b>	Z[7]	Z[6]	Z[5]	Z[4]	Z[3]	Z[2]	Z[1]	Z[0]
<b>Byte 1</b>	REPORT ID (02)							
<b>Byte 2</b>	R-Gui	R-Alt	R-Shift	R-Ctrl	L-Gui	L-Alt	L-Shift	L-Ctrl
<b>Byte 3</b>	0	0	0	0	0	0	0	0
<b>Byte 4</b>	KEY_CODE_ A[7]	KEY_CODE_ A[6]	KEY_CODE_ A[5]	KEY_CODE_ A[4]	KEY_CODE_ A[3]	KEY_CODE_ A[2]	KEY_CODE_ A[1]	KEY_CODE_ A[0]
<b>Byte 5</b>	KEY_CODE_ B[7]	KEY_CODE_ B[6]	KEY_CODE_ B[5]	KEY_CODE_ B[4]	KEY_CODE_ B[3]	KEY_CODE_ B[2]	KEY_CODE_ B[1]	KEY_CODE_ B[0]

<b>Sensor</b>	ADNS-7700-HMMY							
<b>Configuration</b>	3B+TW+KM1/OTF_L, 3B+TW+KM1/OTF_L+ KM2							
<b>Button</b>	5							
<b>Motion Format</b>	12-Bit							
<b>Z-Wheel</b>	Mechanical							
<b>Tilt-Wheel</b>	Enabled							
<b>OTF</b>	Enabled							
<b>KM</b>	Enabled							
	<b>Bit 7</b>	<b>Bit 6</b>	<b>Bit 5</b>	<b>Bit 4</b>	<b>Bit 3</b>	<b>Bit 2</b>	<b>Bit 1</b>	<b>Bit 0</b>
<b>Byte 1</b>	REPORT ID (01)							
<b>Byte 2</b>	0	0	0	0	0	MB	RB	LB
<b>Byte 3</b>	X[7]	X[6]	X[5]	X[4]	X[3]	X[2]	X[1]	X[0]
<b>Byte 4</b>	Y[3]	Y[2]	Y[1]	Y[0]	X[11]	X[10]	X[9]	X[8]
<b>Byte 5</b>	Y[11]	Y[10]	Y[9]	Y[8]	Y[7]	Y[6]	Y[5]	Y[4]
<b>Byte 6</b>	Z[7]	Z[6]	Z[5]	Z[4]	Z[3]	Z[2]	Z[1]	Z[0]
<b>Byte 7</b>	TW[7]	TW[6]	TW[5]	TW[4]	TW[3]	TW[2]	TW[1]	TW[0]
<b>Byte 1</b>	REPORT ID (02)							
<b>Byte 2</b>	R-Gui	R-Alt	R-Shift	R-Ctrl	L-Gui	L-Alt	L-Shift	L-Ctrl
<b>Byte 3</b>	0	0	0	0	0	0	0	0
<b>Byte 4</b>	KEY_CODE_ A[7]	KEY_CODE_ A[6]	KEY_CODE_ A[5]	KEY_CODE_ A[4]	KEY_CODE_ A[3]	KEY_CODE_ A[2]	KEY_CODE_ A[1]	KEY_CODE_ A[0]
<b>Byte 5</b>	KEY_CODE_ B[7]	KEY_CODE_ B[6]	KEY_CODE_ B[5]	KEY_CODE_ B[4]	KEY_CODE_ B[3]	KEY_CODE_ B[2]	KEY_CODE_ B[1]	KEY_CODE_ B[0]

<b>Sensor</b>	ADNS-7700-HMMY							
<b>Configuration</b>	4B+TW+KM1/OTF_L							
<b>Button</b>	5							
<b>Motion Format</b>	12-Bit							
<b>Z-Wheel</b>	Mechanical							
<b>Tilt-Wheel</b>	Enabled							
<b>OTF</b>	Enabled							
<b>KM</b>	Enabled							
	<b>Bit 7</b>	<b>Bit 6</b>	<b>Bit 5</b>	<b>Bit 4</b>	<b>Bit 3</b>	<b>Bit 2</b>	<b>Bit 1</b>	<b>Bit 0</b>
<b>Byte 1</b>	REPORT ID (01)							
<b>Byte 2</b>	0	0	0	0	BB	MB	RB	LB
<b>Byte 3</b>	X[7]	X[6]	X[5]	X[4]	X[3]	X[2]	X[1]	X[0]
<b>Byte 4</b>	Y[3]	Y[2]	Y[1]	Y[0]	X[11]	X[10]	X[9]	X[8]
<b>Byte 5</b>	Y[11]	Y[10]	Y[9]	Y[8]	Y[7]	Y[6]	Y[5]	Y[4]
<b>Byte 6</b>	Z[7]	Z[6]	Z[5]	Z[4]	Z[3]	Z[2]	Z[1]	Z[0]
<b>Byte 7</b>	TW[7]	TW[6]	TW[5]	TW[4]	TW[3]	TW[2]	TW[1]	TW[0]
<b>Byte 1</b>	REPORT ID (02)							
<b>Byte 2</b>	R-Gui	R-Alt	R-Shift	R-Ctrl	L-Gui	L-Alt	L-Shift	L-Ctrl
<b>Byte 3</b>	0	0	0	0	0	0	0	0
<b>Byte 4</b>	KEY_CODE_ A[7]	KEY_CODE_ A[6]	KEY_CODE_ A[5]	KEY_CODE_ A[4]	KEY_CODE_ A[3]	KEY_CODE_ A[2]	KEY_CODE_ A[1]	KEY_CODE_ A[0]

<b>Sensor</b>	ADNS-7700-H4MY, ADNS-7700-HAMY							
<b>Configuration</b>	3B, 3B+OTF+3LED							
<b>Button</b>	3							
<b>Motion Format</b>	16-Bit							
<b>Z-Wheel</b>	Mechanical							
<b>Tilt-Wheel</b>	Disabled							
<b>OTF</b>	Disabled/ Enabled							
<b>KM</b>	Disabled/							
	<b>Bit 7</b>	<b>Bit 6</b>	<b>Bit 5</b>	<b>Bit 4</b>	<b>Bit 3</b>	<b>Bit 2</b>	<b>Bit 1</b>	<b>Bit 0</b>
<b>Byte 1</b>	0	0	0	0	0	MB	RB	LB
<b>Byte 2</b>	X[7]	X[6]	X[5]	X[4]	X[3]	X[2]	X[1]	X[0]
<b>Byte 3</b>	X[15]	X[14]	X[13]	X[12]	X[11]	X[10]	X[9]	X[8]
<b>Byte 4</b>	Y[7]	Y[6]	Y[5]	Y[4]	Y[3]	Y[2]	Y[1]	Y[0]
<b>Byte 5</b>	Y[15]	Y[14]	Y[13]	Y[12]	Y[11]	Y[10]	Y[9]	Y[8]
<b>Byte 6</b>	Z[7]	Z[6]	Z[5]	Z[4]	Z[3]	Z[2]	Z[1]	Z[0]



<b>Sensor</b>	ADNS-7700-H4MY, ADNS-7700-HAMY							
<b>Configuration</b>	3B+TW, 3B+TW+OTF							
<b>Button</b>	3							
<b>Motion Format</b>	16-Bit							
<b>Z-Wheel</b>	Mechanical							
<b>Tilt-Wheel</b>	Enabled							
<b>OTF</b>	Disabled/ Enabled							
<b>KM</b>	Disabled							
	<b>Bit 7</b>	<b>Bit 6</b>	<b>Bit 5</b>	<b>Bit 4</b>	<b>Bit 3</b>	<b>Bit 2</b>	<b>Bit 1</b>	<b>Bit 0</b>
<b>Byte 1</b>	0	0	0	0	0	MB	RB	LB
<b>Byte 2</b>	X[7]	X[6]	X[5]	X[4]	X[3]	X[2]	X[1]	X[0]
<b>Byte 3</b>	X[15]	X[14]	X[13]	X[12]	X[11]	X[10]	X[9]	X[8]
<b>Byte 4</b>	Y[7]	Y[6]	Y[5]	Y[4]	Y[3]	Y[2]	Y[1]	Y[0]
<b>Byte 5</b>	Y[15]	Y[14]	Y[13]	Y[12]	Y[11]	Y[10]	Y[9]	Y[8]
<b>Byte 6</b>	Z[7]	Z[6]	Z[5]	Z[4]	Z[3]	Z[2]	Z[1]	Z[0]
<b>Byte 7</b>	TW[7]	TW[6]	TW[5]	TW[4]	TW[3]	TW[2]	TW[1]	TW[0]

<b>Sensor</b>	ADNS-7700-HCMY, ADNS-7700-HMMY							
<b>Configuration</b>	5B							
<b>Button</b>	5							
<b>Motion Format</b>	16-Bit							
<b>Z-Wheel</b>	Mechanical							
<b>Tilt-Wheel</b>	Disabled							
<b>OTF</b>	Disabled							
<b>KM</b>	Disabled							
	<b>Bit 7</b>	<b>Bit 6</b>	<b>Bit 5</b>	<b>Bit 4</b>	<b>Bit 3</b>	<b>Bit 2</b>	<b>Bit 1</b>	<b>Bit 0</b>
<b>Byte 1</b>	0	0	0	FB	BB	MB	RB	LB
<b>Byte 2</b>	X[7]	X[6]	X[5]	X[4]	X[3]	X[2]	X[1]	X[0]
<b>Byte 3</b>	X[15]	X[14]	X[13]	X[12]	X[11]	X[10]	X[9]	X[8]
<b>Byte 4</b>	Y[7]	Y[6]	Y[5]	Y[4]	Y[3]	Y[2]	Y[1]	Y[0]
<b>Byte 5</b>	Y[15]	Y[14]	Y[13]	Y[12]	Y[11]	Y[10]	Y[9]	Y[8]
<b>Byte 6</b>	Z[7]	Z[6]	Z[5]	Z[4]	Z[3]	Z[2]	Z[1]	Z[0]

<b>Sensor</b>	ADNS-7700-HCMY, ADNS-7700-HMMY							
<b>Configuration</b>	5B+TW							
<b>Button</b>	5							
<b>Motion Format</b>	16-Bit							
<b>Z-Wheel</b>	Mechanical							
<b>Tilt-Wheel</b>	Enabled							
<b>OTF</b>	Disabled							
<b>KM</b>	Disabled							
	<b>Bit 7</b>	<b>Bit 6</b>	<b>Bit 5</b>	<b>Bit 4</b>	<b>Bit 3</b>	<b>Bit 2</b>	<b>Bit 1</b>	<b>Bit 0</b>
<b>Byte 1</b>	0	0	0	0	0	MB	RB	LB
<b>Byte 2</b>	X[7]	X[6]	X[5]	X[4]	X[3]	X[2]	X[1]	X[0]
<b>Byte 3</b>	X[15]	X[14]	X[13]	X[12]	X[11]	X[10]	X[9]	X[8]
<b>Byte 4</b>	Y[7]	Y[6]	Y[5]	Y[4]	Y[3]	Y[2]	Y[1]	Y[0]
<b>Byte 5</b>	Y[15]	Y[14]	Y[13]	Y[12]	Y[11]	Y[10]	Y[9]	Y[8]
<b>Byte 6</b>	Z[7]	Z[6]	Z[5]	Z[4]	Z[3]	Z[2]	Z[1]	Z[0]
<b>Byte 7</b>	TW[7]	TW[6]	TW[5]	TW[4]	TW[3]	TW[2]	TW[1]	TW[0]

<b>Sensor</b>	ADNS-7700-HCMY							
<b>Configuration</b>	5B+ OTF							
<b>Button</b>	5							
<b>Motion Format</b>	16-Bit							
<b>Z-Wheel</b>	Mechanical							
<b>Tilt-Wheel</b>	Disabled							
<b>OTF</b>	Enabled							
<b>KM</b>	Disabled							
	<b>Bit 7</b>	<b>Bit 6</b>	<b>Bit 5</b>	<b>Bit 4</b>	<b>Bit 3</b>	<b>Bit 2</b>	<b>Bit 1</b>	<b>Bit 0</b>
<b>Byte 1</b>	0	0	0	FB	BB	MB	RB	LB
<b>Byte 2</b>	X[7]	X[6]	X[5]	X[4]	X[3]	X[2]	X[1]	X[0]
<b>Byte 3</b>	X[15]	X[14]	X[13]	X[12]	X[11]	X[10]	X[9]	X[8]
<b>Byte 4</b>	Y[7]	Y[6]	Y[5]	Y[4]	Y[3]	Y[2]	Y[1]	Y[0]
<b>Byte 5</b>	Y[15]	Y[14]	Y[13]	Y[12]	Y[11]	Y[10]	Y[9]	Y[8]
<b>Byte 6</b>	Z[7]	Z[6]	Z[5]	Z[4]	Z[3]	Z[2]	Z[1]	Z[0]

<b>Sensor</b>	ADNS-7700-HCMY							
<b>Configuration</b>	4B+TW+OTF							
<b>Button</b>	5							
<b>Motion Format</b>	16-Bit							
<b>Z-Wheel</b>	Mechanical							
<b>Tilt-Wheel</b>	Enabled							
<b>OTF</b>	Enabled							
<b>KM</b>	Disabled							
	<b>Bit 7</b>	<b>Bit 6</b>	<b>Bit 5</b>	<b>Bit 4</b>	<b>Bit 3</b>	<b>Bit 2</b>	<b>Bit 1</b>	<b>Bit 0</b>
<b>Byte 1</b>	0	0	0	0	BB	MB	RB	LB
<b>Byte 2</b>	X[7]	X[6]	X[5]	X[4]	X[3]	X[2]	X[1]	X[0]
<b>Byte 3</b>	X[15]	X[14]	X[13]	X[12]	X[11]	X[10]	X[9]	X[8]
<b>Byte 4</b>	Y[7]	Y[6]	Y[5]	Y[4]	Y[3]	Y[2]	Y[1]	Y[0]
<b>Byte 5</b>	Y[15]	Y[14]	Y[13]	Y[12]	Y[11]	Y[10]	Y[9]	Y[8]
<b>Byte 6</b>	Z[7]	Z[6]	Z[5]	Z[4]	Z[3]	Z[2]	Z[1]	Z[0]
<b>Byte 7</b>	TW[7]	TW[6]	TW[5]	TW[4]	TW[3]	TW[2]	TW[1]	TW[0]

<b>Sensor</b>	ADNS-7700-HMMY							
<b>Configuration</b>	5B+KM1/OTF_L, 5B+KM1/OTF_L+ KM2							
<b>Button</b>	5							
<b>Motion Format</b>	16-Bit							
<b>Z-Wheel</b>	Mechanical							
<b>Tilt-Wheel</b>	Disabled							
<b>OTF</b>	Enabled							
<b>KM</b>	Enabled							
	<b>Bit 7</b>	<b>Bit 6</b>	<b>Bit 5</b>	<b>Bit 4</b>	<b>Bit 3</b>	<b>Bit 2</b>	<b>Bit 1</b>	<b>Bit 0</b>
<b>Byte 1</b>	REPORT ID (01)							
<b>Byte 2</b>	0	0	0	FB	BB	MB	RB	LB
<b>Byte 3</b>	X[7]	X[6]	X[5]	X[4]	X[3]	X[2]	X[1]	X[0]
<b>Byte 4</b>	X[15]	X[14]	X[13]	X[12]	X[11]	X[10]	X[9]	X[8]
<b>Byte 5</b>	Y[7]	Y[6]	Y[5]	Y[4]	Y[3]	Y[2]	Y[1]	Y[0]
<b>Byte 6</b>	Y[15]	Y[14]	Y[13]	Y[12]	Y[11]	Y[10]	Y[9]	Y[8]
<b>Byte 7</b>	Z[7]	Z[6]	Z[5]	Z[4]	Z[3]	Z[2]	Z[1]	Z[0]
<b>Byte 1</b>	REPORT ID (02)							
<b>Byte 2</b>	R-Gui	R-Alt	R-Shift	R-Ctrl	L-Gui	L-Alt	L-Shift	L-Ctrl
<b>Byte 3</b>	0	0	0	0	0	0	0	0
<b>Byte 4</b>	KEY_CODE_ A[7]	KEY_CODE_ A[6]	KEY_CODE_ A[5]	KEY_CODE_ A[4]	KEY_CODE_ A[3]	KEY_CODE_ A[2]	KEY_CODE_ A[1]	KEY_CODE_ A[0]
<b>Byte 5</b>	KEY_CODE_ B[7]	KEY_CODE_ B[6]	KEY_CODE_ B[5]	KEY_CODE_ B[4]	KEY_CODE_ B[3]	KEY_CODE_ B[2]	KEY_CODE_ B[1]	KEY_CODE_ B[0]

<b>Sensor</b>	ADNS-7700-HMMY							
<b>Configuration</b>	3B+TW+KM1/OTF_L, 3B+TW+KM1/OTF_L+ KM2							
<b>Button</b>	5							
<b>Motion Format</b>	16-Bit							
<b>Z-Wheel</b>	Mechanical							
<b>Tilt-Wheel</b>	Enabled							
<b>OTF</b>	Enabled							
<b>KM</b>	Enabled							
	<b>Bit 7</b>	<b>Bit 6</b>	<b>Bit 5</b>	<b>Bit 4</b>	<b>Bit 3</b>	<b>Bit 2</b>	<b>Bit 1</b>	<b>Bit 0</b>
<b>Byte 1</b>	REPORT ID (01)							
<b>Byte 2</b>	0	0	0	FB	BB	MB	RB	LB
<b>Byte 3</b>	X[7]	X[6]	X[5]	X[4]	X[3]	X[2]	X[1]	X[0]
<b>Byte 4</b>	X[15]	X[14]	X[13]	X[12]	X[11]	X[10]	X[9]	X[8]
<b>Byte 5</b>	Y[7]	Y[6]	Y[5]	Y[4]	Y[3]	Y[2]	Y[1]	Y[0]
<b>Byte 6</b>	Y[15]	Y[14]	Y[13]	Y[12]	Y[11]	Y[10]	Y[9]	Y[8]
<b>Byte 7</b>	Z[7]	Z[6]	Z[5]	Z[4]	Z[3]	Z[2]	Z[1]	Z[0]
<b>Byte 8</b>	TW[7]	TW[6]	TW[5]	TW[4]	TW[3]	TW[2]	TW[1]	TW[0]
<b>Byte 1</b>	REPORT ID (02)							
<b>Byte 2</b>	R-Gui	R-Alt	R-Shift	R-Ctrl	L-Gui	L-Alt	L-Shift	L-Ctrl
<b>Byte 3</b>	0	0	0	0	0	0	0	0
<b>Byte 4</b>	KEY_CODE_ A[7]	KEY_CODE_ A[6]	KEY_CODE_ A[5]	KEY_CODE_ A[4]	KEY_CODE_ A[3]	KEY_CODE_ A[2]	KEY_CODE_ A[1]	KEY_CODE_ A[0]
<b>Byte 5</b>	KEY_CODE_ B[7]	KEY_CODE_ B[6]	KEY_CODE_ B[5]	KEY_CODE_ B[4]	KEY_CODE_ B[3]	KEY_CODE_ B[2]	KEY_CODE_ B[1]	KEY_CODE_ B[0]

<b>Sensor</b>	ADNS-7700-HMMY							
<b>Configuration</b>	4B+TW+KM1/OTF_L							
<b>Button</b>	5							
<b>Motion Format</b>	16-Bit							
<b>Z-Wheel</b>	Mechanical							
<b>Tilt-Wheel</b>	Enabled							
<b>OTF</b>	Enabled							
<b>KM</b>	Enabled							
	<b>Bit 7</b>	<b>Bit 6</b>	<b>Bit 5</b>	<b>Bit 4</b>	<b>Bit 3</b>	<b>Bit 2</b>	<b>Bit 1</b>	<b>Bit 0</b>
<b>Byte 1</b>	REPORT ID (01)							
<b>Byte 2</b>	0	0	0	0	BB	MB	RB	LB
<b>Byte 3</b>	X[7]	X[6]	X[5]	X[4]	X[3]	X[2]	X[1]	X[0]
<b>Byte 4</b>	X[15]	X[14]	X[13]	X[12]	X[11]	X[10]	X[9]	X[8]
<b>Byte 5</b>	Y[7]	Y[6]	Y[5]	Y[4]	Y[3]	Y[2]	Y[1]	Y[0]
<b>Byte 6</b>	Y[15]	Y[14]	Y[13]	Y[12]	Y[11]	Y[10]	Y[9]	Y[8]
<b>Byte 7</b>	Z[7]	Z[6]	Z[5]	Z[4]	Z[3]	Z[2]	Z[1]	Z[0]
<b>Byte 8</b>	TW[7]	TW[6]	TW[5]	TW[4]	TW[3]	TW[2]	TW[1]	TW[0]
<b>Byte 1</b>	REPORT ID (02)							
<b>Byte 2</b>	R-Gui	R-Alt	R-Shift	R-Ctrl	L-Gui	L-Alt	L-Shift	L-Ctrl
<b>Byte 3</b>	0	0	0	0	0	0	0	0
<b>Byte 4</b>	KEY_CODE_ A[7]	KEY_CODE_ A[6]	KEY_CODE_ A[5]	KEY_CODE_ A[4]	KEY_CODE_ A[3]	KEY_CODE_ A[2]	KEY_CODE_ A[1]	KEY_CODE_ A[0]

## Registers

The sensor can be programmed through registers, via the USB port, and configuration and motion data can be read from these registers. The registers will be “disabled” by VDD5 going low or sending a USB reset command.

Address	Register Name	Register Type	Access	Reset Value
0x00	PROD_ID	Device	Read only	0x37
0x01	REV_ID	Device	Read only	0x01
0x02	BUT_STAT	Device	Read only	Undefined
0x03	DELTA_X_H	Device	Read only	0x00
0x04	DELTA_X_L	Device	Read only	0x00
0x05	DELTA_Y_H	Device	Read only	0x00
0x06	DELTA_Y_L	Device	Read only	0x00
0x07	MOTZ	Device	Read only	0x00
0x08	SQUAL	Device	Read only	Undefined
0x09	SHUT_HI	Device	Read only	0x00
0x0A	SHUT_LO	Device	Read only	Undefined
0x0B	PIX_MAX	Device	Read only	Undefined
0x0C	PIX_ACCUM	Device	Read only	Undefined
0x0D	PIX_MIN	Device	Read only	Undefined
0x0E	PIX_GRABBER	Device	Read/Write	0x00
0x4C	OTP_CONFIG	Device	Read/Write	0x00
0x4D	OTP_ADDR	Device	Read/Write	0x00
0x4E	OTP_DATA	Device	Read/Write	0x00
0x4F	OTP_CTRL	Device	Read/Write	0x00
0x50	OTP_CTRLSTAT	Device	Read only	Undefined
0x51	OTP_RUNSTAT	Device	Read only	Undefined
0x75	LSR_CTRL0	Device	Read/Write	0x00
0x76	LSR_CTRL1	Device	Read/Write	0x0F
0x7E	INV_REV_ID	Device	Read only	0xFE
0xBB	L2_USE_OTP	OTP	Read/Write	0x00
0xBC	CPI_SET0	OTP	Read/Write	0x0A
0xBD	CPI_SET1	OTP	Read/Write	0x10
0xBE	CPI_SET2	OTP	Read/Write	0x05
0xBF	MOTCONFIG1	OTP	Read/Write	0x00
0xC0	ROTATION	OTP	Read/Write	0x07
0xC1	DEVCONFIG	OTP	Read/Write	0x00
0xC2	CODEA_KEY1	OTP	Read/Write	0x00
0xC3	CODEB_KEY1	OTP	Read/Write	0x00
0xC4	CODEA_KEY2	OTP	Read/Write	0x00
0xC5	CODEB_KEY2	OTP	Read/Write	0x00
0xC6	LONGPRESS	OTP	Read/Write	0x10
0xC7	TW_CONFIG	OTP	Read/Write	0x00
0xC8 : 0xC9	PID1 : PID0	OTP	Read/Write	0x0716
0xCA : 0xCB	VID1 : VID0	OTP	Read/Write	0x192F
0xCC	MSTR_LEN	OTP	Read/Write	0x0C
0xCD : 0xD8	MSTR_STR	OTP	Read/Write	Avago
0xD9	PSTR_LEN	OTP	Read/Write	0x34
0xDA : 0xF5	PROD_STR	OTP	Read/Write	USB LaserStream(TM) Mouse
0xF6 : 0xF7	DEV_NUM	OTP	Read/Write	0x00
0xFA	OTPLOCK2	OTP	Read/Write	0x00

**PROD\_ID** Address: 0x00  
 Access: Read Only Reset Value: 0x37

<b>Bit</b>	7	6	5	4	3	2	1	0
<b>Field</b>	PID <sub>7</sub>	PID <sub>6</sub>	PID <sub>5</sub>	PID <sub>4</sub>	PID <sub>3</sub>	PID <sub>2</sub>	PID <sub>1</sub>	PID <sub>0</sub>

Data Type: 8-bit number with the product identifier.

USAGE: The value in this register does not change; it can be used to verify that the sensor communications link is OK.

**REV\_ID** Address: 0x01  
 Access: Read Only Reset Value: 0x01

<b>Bit</b>	7	6	5	4	3	2	1	0
<b>Field</b>	RID <sub>7</sub>	RID <sub>6</sub>	RID <sub>5</sub>	RID <sub>4</sub>	RID <sub>3</sub>	RID <sub>2</sub>	RID <sub>1</sub>	RID <sub>0</sub>

Data Type: 8-bit number with current revision of the IC.

USAGE: This register contains the IC revision. It is subject to change when new IC versions are released.

**BUT\_STAT** Address: 0x02 Type: Device  
 Access: Read Only Reset Value: Undefined

<b>Bit</b>	7	6	5	4	3	2	1	0
<b>Field</b>	Reserved	BUT <sub>7</sub>	BUT <sub>6</sub>	BUT <sub>5</sub>	BUT <sub>4</sub>	BUT <sub>3</sub>	BUT <sub>2</sub>	BUT <sub>1</sub>

Data Type: Bit field

USAGE: This register is included for *test purposes only*. For navigation use, use the USB HID defined commands. The button status bits reported are for the debounce signals.

Field Name	Description
BUT <sub>7</sub>	Reports the status of TW2 (Right tilt) 0 = pin signal is at logic 1 (VDD5) 1 = pin signal is at logic 0 (GND)
BUT <sub>6</sub>	Reports the status of TW1 (Left tilt) 0 = pin signal is at logic 1 (VDD5) 1 = pin signal is at logic 0 (GND)
BUT <sub>5</sub>	When used as a 5 button mouse, reports the status of B5 button pin 0 = pin signal is at logic 1 (VDD5) 1 = pin signal is at logic 0 (GND)
BUT <sub>4</sub>	When used as a 5 button mouse, reports the status of B4 button pin 0 = pin signal is at logic 1 (VDD5) 1 = pin signal is at logic 0 (GND)
BUT <sub>3</sub>	Reports the status of B3 0 = pin signal is at logic 1 (VDD5) 1 = pin signal is at logic 0 (GND)
BUT <sub>2</sub>	Reports the status of B2 0 = pin signal is at logic 1 (VDD5) 1 = pin signal is at logic 0 (GND)
BUT <sub>1</sub>	Reports the status of B1 0 = pin signal is at logic 1 (VDD5) 1 = pin signal is at logic 0 (GND)

<b>DELTA_X_H</b>		Address: 0x03						Type: Device
Access: Read Only		Reset Value: 0x00						
<b>Bit</b>	7	6	5	4	3	2	1	0
<b>Field</b>	X <sub>15</sub>	X <sub>14</sub>	X <sub>13</sub>	X <sub>12</sub>	X <sub>11</sub>	X <sub>10</sub>	X <sub>9</sub>	X <sub>8</sub>

<b>DELTA_X_L</b>		Address: 0x04						Type: Device
Access: Read Only		Reset Value: 0x00						
<b>Bit</b>	7	6	5	4	3	2	1	0
<b>Field</b>	X <sub>7</sub>	X <sub>6</sub>	X <sub>5</sub>	X <sub>4</sub>	X <sub>3</sub>	X <sub>2</sub>	X <sub>1</sub>	X <sub>0</sub>

Data Type: 16-Bit 2's Complement Data

USAGE: The value in this register reflects the last USB delta X data output or data queued for output. This register is included for *test purposes only*. For navigation use, use the HID defined commands. Absolute value is determined by the currently set resolution.

**Register read sequence Delta\_X\_H->Delta\_X\_L->Delta\_Y\_H->Delta\_Y\_L**

<b>DELTA_Y_H</b>		Address: 0x05						Type: Device
Access: Read Only		Reset Value: 0x00						
<b>Bit</b>	7	6	5	4	3	2	1	0
<b>Field</b>	Y <sub>15</sub>	Y <sub>14</sub>	Y <sub>13</sub>	Y <sub>12</sub>	Y <sub>11</sub>	Y <sub>10</sub>	Y <sub>9</sub>	Y <sub>8</sub>

<b>DELTA_Y_L</b>		Address: 0x06						Type: Device
Access: Read Only		Reset Value: 0x00						
<b>Bit</b>	7	6	5	4	3	2	1	0
<b>Field</b>	Y <sub>7</sub>	Y <sub>6</sub>	Y <sub>5</sub>	Y <sub>4</sub>	Y <sub>3</sub>	Y <sub>2</sub>	Y <sub>1</sub>	Y <sub>0</sub>

Data Type: 16-Bit 2's Complement Data

USAGE: The value in this register reflects the last USB delta Y data output or data queued for output. This register is included for *test purposes only*. For navigation use, use the HID defined commands. Absolute value is determined by the currently set resolution.

**Register read sequence Delta\_X\_H->Delta\_X\_L->Delta\_Y\_H->Delta\_Y\_L**

<b>MOTZ</b>		Address: 0x07						Type: Device
Access: Read Only		Reset Value: 0x00						
<b>Bit</b>	7	6	5	4	3	2	1	0
<b>Field</b>	Z <sub>7</sub>	Z <sub>6</sub>	Z <sub>5</sub>	Z <sub>4</sub>	Z <sub>3</sub>	Z <sub>2</sub>	Z <sub>1</sub>	Z <sub>0</sub>

Data Type: 8-Bit field

USAGE: If mouse is configured to contain a Z-wheel, this register contains the Z-wheel count. Range is from -127 to +127 decimal.



<b>SQUAL</b>	Address: 0x08							Type: Device
Access: Read Only	Reset Value: Undefined							
<b>Bit</b>	7	6	5	4	3	2	1	0
<b>Field</b>	SQ <sub>7</sub>	SQ <sub>6</sub>	SQ <sub>5</sub>	SQ <sub>4</sub>	SQ <sub>3</sub>	SQ <sub>2</sub>	SQ <sub>1</sub>	SQ <sub>0</sub>

Data Type: Upper 8bits of a 10-bit unsigned integer

USAGE: SQUAL (Surface Quality) is a measure of ¼ of the number of valid features visible by the sensor in the current frame. Use the following formula to find the total number of valid features. The values range from 0 to 144.

$$\text{Number of features} = \text{SQUAL register value} * 4$$

Since small changes in the current frame can result in changes in SQUAL, slight variations in SQUAL on one surface is expected. The graph below shows 800 sequentially acquired SQUAL values, while a sensor was moved slowly over white paper. SQUAL is nearly equal to zero, if there is no surface below the sensor. SQUAL is typically maximized when the navigation surface is at the optimum distance from the imaging lens (the nominal Z-height).

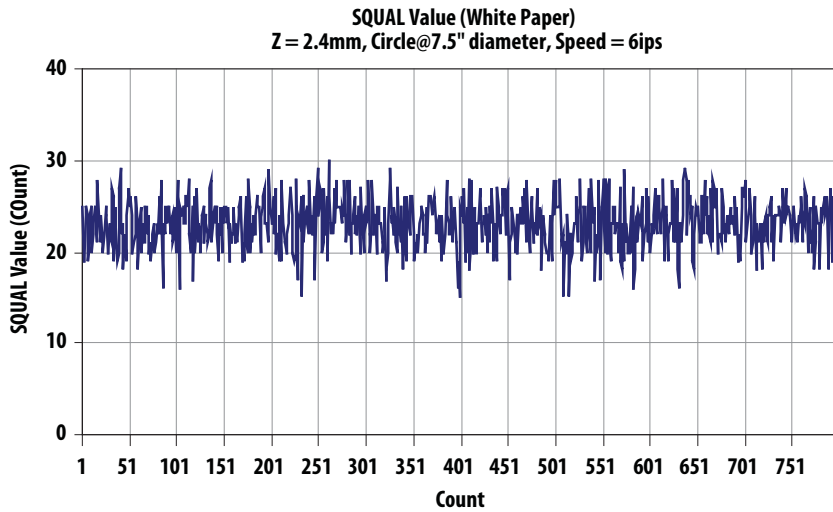

Figure 23. SQUAL Values (white paper)

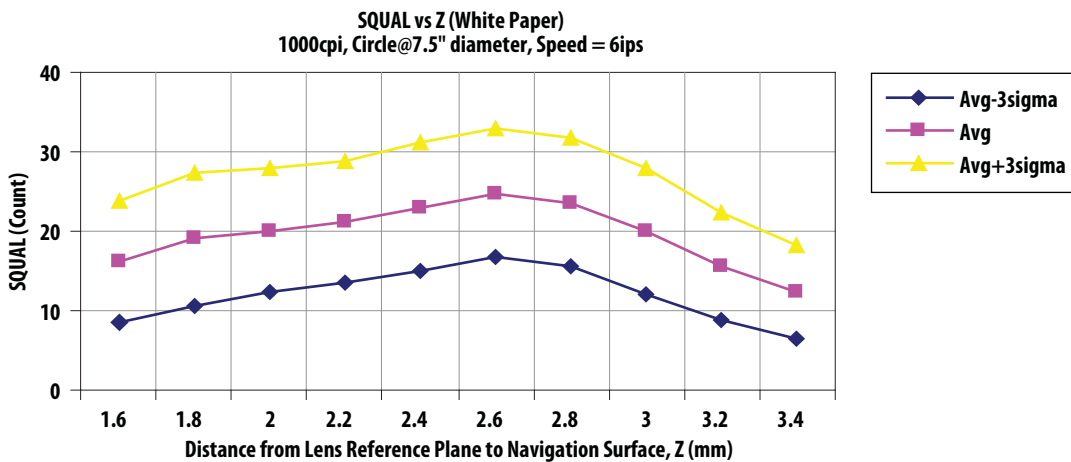

Figure 24. Mean SQUAL vs. Z (white paper)

**SHUT\_HI** Address: 0x9 Type: Device  
 Access: Read Oly Reset Value: 0x00

Bit	7	6	5	4	3	2	1	0
Field	S <sub>15</sub>	S <sub>14</sub>	S <sub>13</sub>	S <sub>12</sub>	S <sub>11</sub>	S <sub>10</sub>	S <sub>9</sub>	S <sub>8</sub>

**SHUT\_LO** Address: 0x0A Type: Device  
 Access: Read Only Reset Value: Undefined

Bit	7	6	5	4	3	2	1	0
Field	S <sub>7</sub>	S <sub>6</sub>	S <sub>5</sub>	S <sub>4</sub>	S <sub>3</sub>	S <sub>2</sub>	S <sub>1</sub>	S <sub>0</sub>

Data Type: 16-bit number.

USAGE: The combination of SHUT\_HI and SHUT\_LO is a 16-bit number. This is the number of clocks the shutter was open for the last image taken. The units are in main clocks ticks (nominally 24MHz). To avoid split read issues, read SHUT\_Hi first.

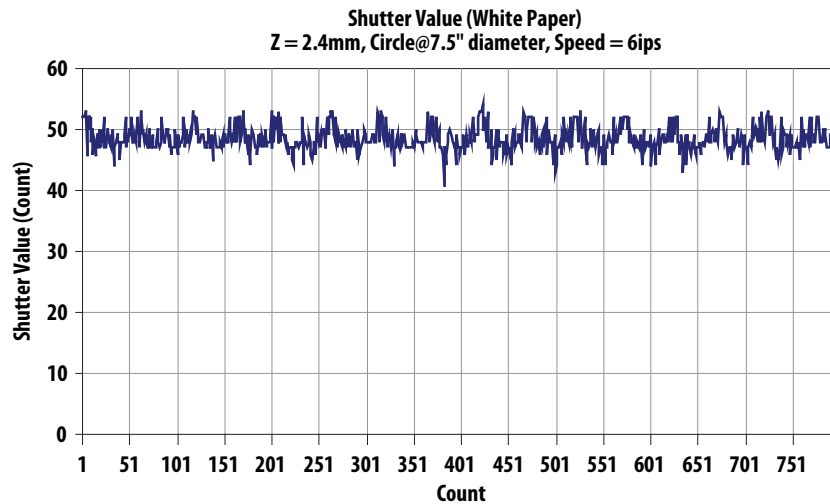

Figure 25. Shutter Values (white paper)

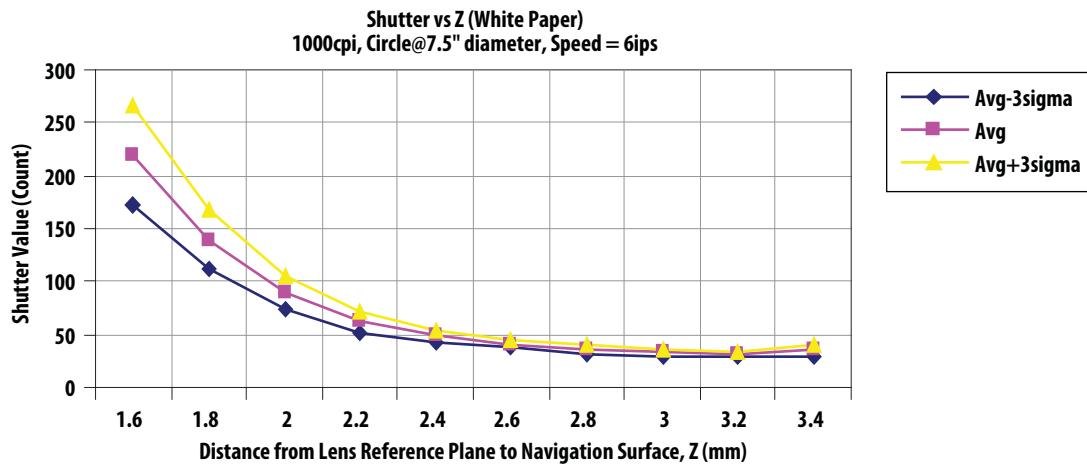

Figure 26. Mean Shutter vs. Z (white paper)

<b>PIX_MAX</b>		Address: 0x0B					Type: Device	
Access: Read Only		Reset Value: Undefined						
<b>Bit</b>	7	6	5	4	3	2	1	0
<b>Field</b>	0	MX <sub>6</sub>	MX <sub>5</sub>	MX <sub>4</sub>	MX <sub>3</sub>	MX <sub>2</sub>	MX <sub>1</sub>	MX <sub>0</sub>

Data Type: 7-bit number.

USAGE: This is the maximum pixel value from the last image taken.

<b>PIX_ACCUM</b>		Address: 0x0C					Type: Device	
Access: Read Only		Reset Value: Undefined						
<b>Bit</b>	7	6	5	4	3	2	1	0
<b>Field</b>	AC <sub>7</sub>	AC <sub>6</sub>	AC <sub>5</sub>	AC <sub>4</sub>	AC <sub>3</sub>	AC <sub>2</sub>	AC <sub>1</sub>	AC <sub>0</sub>

Data Type: High 8bits of 17-bit unsigned integer

USAGE: This is the accumulated pixel value from the last image taken. This register is used to find the average pixel value. For the 24x24 array raw image, only the upper 8bits are reported ([16:9]).

$$\text{Pixel\_Average} = \text{PIX\_ACCUM} / 1.125$$

<b>PIX_MIN</b>		Address: 0x0D					Type: Device	
Access: Read Only		Reset Value: Undefined						
<b>Bit</b>	7	6	5	4	3	2	1	0
<b>Field</b>	0	MN <sub>6</sub>	MN <sub>5</sub>	MN <sub>4</sub>	MN <sub>3</sub>	MN <sub>2</sub>	MN <sub>1</sub>	MN <sub>0</sub>

Data Type: 8-bit number.

USAGE: This is the minimum pixel value from the last image taken.

<b>PIX_GRABBER</b>		Address: 0x0E				Type: Device		
Access: Read/Write		Reset Value: 0x00						
<b>Bit</b>	7	6	5	4	3	2	1	0
<b>Field</b>	VALID	PG <sub>6</sub>	PG <sub>5</sub>	PG <sub>4</sub>	PG <sub>3</sub>	PG <sub>2</sub>	PG <sub>1</sub>	PG <sub>0</sub>

Data Type: 8-bit number.

USAGE: The pixel grabber captures 1 pixel per frame. If there is a valid pixel in the grabber when this is read, the MSB will be set, an internal counter will be incremented to capture the next pixel and the grabber will be armed to capture the next pixel. It will take 576 reads to upload the completed image. For each pixel read, the register should be polled (continuously read) until VALID = 1 before the PG [6:0] is taken as valid pixel data. Any write to this register will reset and arm the grabber to grab pixel 0 on the next image.

The X and Y directions with respect to the mouse case are shown in Figure 27. See pixel array numbering in Figure 28 that shows the readout order of the array. Rows are read from bottom to top and columns are from left to right.

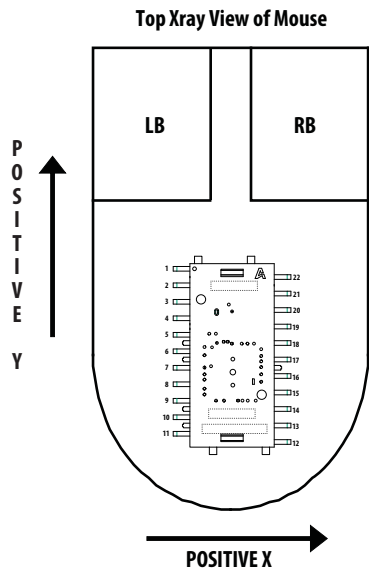

Figure 27. Directions are for a complete mouse, with the ADNS-6180-001 or ADNS-6180-002 lens

**Sensor looking at the navigation surface through the ADNS-6180-001 or ADNS-6180-002 lens from top of mouse.**

575	551	527	503	479	455	431	407	383	359	335	311	287	263	239	215	191	167	143	119	95	71	47	23
574	550	526	502	478	454	430	406	382	358	334	310	286	262	238	214	190	166	142	118	94	70	46	22
573	549	525	501	477	453	429	405	381	357	333	309	285	261	237	213	189	165	141	117	93	69	45	21
572	548	524	500	476	452	428	404	380	356	332	308	284	260	236	212	188	164	140	116	92	68	44	20
571	547	523	499	475	451	427	403	379	355	331	307	283	259	235	211	187	163	139	115	91	67	43	19
570	546	522	498	474	450	426	402	378	354	330	306	282	258	234	210	186	162	138	114	90	66	42	18
569	545	521	497	473	449	425	401	377	353	329	305	281	257	233	209	185	161	137	113	89	65	41	17
568	544	520	496	472	448	424	400	376	352	328	304	280	256	232	208	184	160	136	112	88	64	40	16
567	543	519	495	471	447	423	399	375	351	327	303	279	255	231	207	183	159	135	111	87	63	39	15
566	542	518	494	470	446	422	398	374	350	326	302	278	254	230	206	182	158	134	110	86	62	38	14
565	541	517	493	469	445	421	397	373	349	325	301	277	253	229	205	181	157	133	109	85	61	37	13
564	540	516	492	468	444	420	396	372	348	324	300	276	252	228	204	180	156	132	108	84	60	36	12
563	539	515	491	467	443	419	395	371	347	323	299	275	251	227	203	179	155	131	107	83	59	35	11
562	538	514	490	466	442	418	394	370	346	322	298	274	250	226	202	178	154	130	106	82	58	34	10
561	537	513	489	465	441	417	393	369	345	321	297	273	249	225	201	177	153	129	105	81	57	33	9
560	536	512	488	464	440	416	392	368	344	320	296	272	248	224	200	176	152	128	104	80	56	32	8
559	535	511	487	463	439	415	391	367	343	319	295	271	247	223	199	175	151	127	103	79	55	31	7
558	534	510	486	462	438	414	390	366	342	318	294	270	246	222	198	174	150	126	102	78	54	30	6
557	533	509	485	461	437	413	389	365	341	317	293	269	245	221	197	173	149	125	101	77	53	29	5
556	532	508	484	460	436	412	388	364	340	316	292	268	244	220	196	172	148	124	100	76	52	28	4
555	531	507	483	459	435	411	387	363	339	315	291	267	243	219	195	171	147	123	99	75	51	27	3
554	530	506	482	458	434	410	386	362	338	314	290	266	242	218	194	170	146	122	98	74	50	26	2
553	529	505	481	457	433	409	385	361	337	313	289	265	241	217	193	169	145	121	97	73	49	25	1
552	528	504	480	456	432	408	384	360	336	312	288	264	240	216	192	168	144	120	96	72	48	24	0

**Figure 28. Pixel Address Map of Navigation Surface Image**

<b>OTP_CONFIG</b>			Address: 0x4C				Type: Device		
Access: Read/Write			Reset Value: 0x00						
<b>Bit</b>	7	6	5	4	3	2	1	0	
<b>Field</b>	Reserved	Reserved	Reserved	Reserved	Reserved	Reserved	Reserved	OTP_EN	

Data Type: Bit field

USAGE: OTP commands enable/disable. Refer to OTP programming section.

Field Name	Description
OTP_EN	OTP commands 1 = Enabled <b>0 = Disabled</b>

<b>OTP_ADDR</b>			Address: 0x4D				Type: Device		
Access: Read/Write			Reset Value: 0x00						
<b>Bit</b>	7	6	5	4	3	2	1	0	
<b>Field</b>	OTP_ADDR <sub>7</sub>	OTP_ADDR <sub>6</sub>	OTP_ADDR <sub>5</sub>	OTP_ADDR <sub>4</sub>	OTP_ADDR <sub>3</sub>	OTP_ADDR <sub>2</sub>	OTP_ADDR <sub>1</sub>	OTP_ADDR <sub>0</sub>	

Data Type: 8-bit number

USAGE: This register is the container of OTP address in OTP read/write command. Refer to OTP programming section.

<b>OTP_DATA</b>			Address: 0x4E				Type: Device		
Access: Read/Write			Reset Value: 0x00						
<b>Bit</b>	7	6	5	4	3	2	1	0	
<b>Field</b>	OTP_DATA <sub>7</sub>	OTP_DATA <sub>6</sub>	OTP_DATA <sub>5</sub>	OTP_DATA <sub>4</sub>	OTP_DATA <sub>3</sub>	OTP_DATA <sub>2</sub>	OTP_DATA <sub>1</sub>	OTP_DATA <sub>0</sub>	

Data Type: 8-bit number

USAGE: This register is the container of OTP data value in OTP read/write command. Refer to OTP programming section.

**OTP\_CTRL**

Access: Read/Write

Address: 0x4F

Reset Value: 0x00

Type: Device

Bit	7	6	5	4	3	2	1	0
Field	Reserved	Reserved	Reserved	Reserved	Reserved	LOCK_L2	RD	WR

Data Type: Bit field

USAGE: This register controls the read, write and lock commands of OTP. The commands are auto clear for status check. Refer to OTP programming section.

Field Name	Description
WR	Enable write command to OTP 1 = Write to OTP <b>0 = Write command is completed</b>
RD	Enable read command to OTP 1 = Read from OTP <b>0 = Data is ready to be read from OTP_DATA register</b>
LOCK_L2	Enable OTP lock command 1 = Lock OTP space <b>0 = Lock command is completed</b>

**OTP\_CTRLSTAT**

Access: Read only

Address: 0x50

Reset Value: Undefined

Type: Device

Bit	7	6	5	4	3	2	1	0
Field	Reserved	Reserved	Reserved	Reserved	L2_CRC_OK	L2_LOCK_OK	WR_DENIED	WR_OK

Data Type: Bit field

USAGE: This register shows the OTP control status. Refer to OTP programming section.

Field Name	Description
WR_OK	OTP write status 1 = OK 0 = Failed
WR_DENIED	OTP write access status 1 = Denied 0 = OK
L2_LOCK_OK	OTP lock status 1 = OK 0 = Failed
L2_CRC_OK	CRC test status 1 = OK 0 = Failed

**OTP\_RUNSTAT**

Access: Read only

Address: 0x51

Reset Value: Undefined

Type: Device

Bit	7	6	5	4	3	2	1	0
Field	Reserved	L2_CHECKED	L2_LOCK	L2_USED	Reserved	Reserved	Reserved	DEV_RDY

Data Type: Bit field

USAGE: This register shows the OTP run status. Refer to OTP programming section.

Field Name	Description
DEV_RDY	Device status 1 = Ready, reading or writing to OTP register is allowed 0 = Busy, do not read or write to OTP register yet
L2_USED	OTP space status 1 = Used 0 = Unused
L2_LOCKED	OTP space locking status 1 = Locked 0 = Open
L2_CHECKED	OTP status check 1 = Checked 0 = Unchecked

**LSR\_CTRL0**

Access: Read/Write

Address: 0x75

Reset Value: 0x00

Type: Device

Bit	7	6	5	4	3	2	1	0
Field	0	0	0	0	0	LSR_CW1	0	LSR_CW0

Data Type: Bit field

USAGE: This register is included strictly for *test purposes only*. It is to be used with LSR\_CTRL1 register, 0x76 where LSR\_CW\_COMP1 and LSR\_CW\_COMP0 bits must contain the complement of LSR\_CW1 and LSR\_CW0 bits in order to set the laser to continuous (CW) mode. Other bits MUST be set to 0.

Field Name	Description
LSR_CW1 : LSR_CW0	Laser drive mode 11 = CW mode ON <b>00 = Normal operation in pulse mode</b>



<b>LSR_CTRL1</b>		Address: 0x76				Type: Device			
Access: Read/Write		Reset Value: 0x0F							
<b>Bit</b>	7	6	5	4	3	2	1	0	
<b>Field</b>	0	0	0	0	0	LSR_CW_ COMP1	0	LSR_CW_ COMP0	

Data Type: Bit field

USAGE: This register is included strictly for *test purposes only*. It is to be used with LSR\_CTRL1 register, 0x76 where LSR\_CW\_COMP1 and LSR\_CW\_COMP0 bits must contain the complement of LSR\_CW1 and LSR\_CW0 bits in order to set the laser to continuous (CW) mode. Other bits MUST be set to 0.

Field Name	Description
LSR_CW_COMP1 : LSR_CW_COMP0	MUST be complement of LSR_CW[1-0] bit in register 0x75

<b>INV_REV_ID</b>		Address: 0x7E				Type: Device			
Access: Read only		Reset Value: 0xFE							
<b>Bit</b>	7	6	5	4	3	2	1	0	
<b>Field</b>	INV_RID <sub>7</sub>	INV_RID <sub>6</sub>	INV_RID <sub>5</sub>	INV_RID <sub>4</sub>	INV_RID <sub>3</sub>	INV_RID <sub>2</sub>	INV_RID <sub>1</sub>	INV_RID <sub>0</sub>	

Data Type: 8-bit number with current revision of the IC.

USAGE: Contains the inverse of the revision ID which is located in register 0x01.

<b>L2_USE_OTP</b>		Address: 0xBB				Type: OTP			
Access: Read/Write		Reset Value: 0x00							
<b>Bit</b>	7	6	5	4	3	2	1	0	
<b>Field</b>	L2_USE_ OTP <sub>7</sub>	L2_USE_ OTP <sub>6</sub>	L2_USE_ OTP <sub>5</sub>	L2_USE_ OTP <sub>4</sub>	L2_USE_ OTP <sub>3</sub>	L2_USE_ OTP <sub>2</sub>	L2_USE_ OTP <sub>1</sub>	L2_USE_ OTP <sub>0</sub>	

Data Type: 8-bit field.

USAGE: Bypass OTP configuration if all bits are zero. MUST write 0xFF to this register to enable OTP operation. Once enabled, all OTP registers must be written as the default values are zero value.

**CPI\_SET0**

Access: Read/Write

Address: 0xBC  
Reset Value: 0x0A

Type: OTP

<b>Bit</b>	7	6	5	4	3	2	1	0
<b>Field</b>	Reserved	Reserved	Reserved	CPI0 <sub>4</sub>	CPI0 <sub>3</sub>	CPI0 <sub>2</sub>	CPI0 <sub>1</sub>	CPI0 <sub>0</sub>

Data Type: 8-Bit field

USAGE: This register sets the default resolution setting when the sensor is powered up. It is also the default 1<sup>st</sup> resolution setting (S1) when On-the-Fly (OTF) resolution mode is enabled. The performance of max setting is surface dependent. The resolution settings shown below are approximate values.

<b>CPI0[4:0]</b>	<b>Approximate Resolution (cpi)</b>	<b>CPI0[4:0]</b>	<b>Approximate Resolution (cpi)</b>
00000-00011	Reserved	01111	1500
00100	400	10000	1600
00101	500	10001	1700
00110	600	10010	1800
00111	700	10011	1900
01000	800	10100	2000
01001	900	10101	2100
<b>01010</b>	<b>1000</b>	10110	2200
01011	1100	10111	2300
01100	1200	11000	2400
01101	1300	11001-11111	Reserved
01110	1400		

**CPI\_SET1**

Access: Read/Write

Address: 0xBD  
Reset Value: 0x10

Type: OTP

<b>Bit</b>	7	6	5	4	3	2	1	0
<b>Field</b>	Reserved	Reserved	Reserved	CPI1 <sub>4</sub>	CPI1 <sub>3</sub>	CPI1 <sub>2</sub>	CPI1 <sub>1</sub>	CPI1 <sub>0</sub>

Data Type: 8-Bit field

USAGE: This register sets the 2<sup>nd</sup> resolution setting (S2) when On-the-Fly (OTF) resolution mode is enabled. The performance of max setting is surface dependent. Refer to resolution table in CPI\_SET0.

<b>CPI_SET2</b>			Address: 0xBE				Type: OTP	
Access: Read/Write			Reset Value: 0x05					
<b>Bit</b>	7	6	5	4	3	2	1	0
<b>Field</b>	Reserved	Reserved	Reserved	CPI2 <sub>4</sub>	CPI2 <sub>3</sub>	CPI2 <sub>2</sub>	CPI2 <sub>1</sub>	CPI2 <sub>0</sub>

Data Type: 8-Bit field

USAGE: This register sets the 3<sup>rd</sup> resolution setting (S3) when On-the-Fly (OTF) resolution mode is enabled. The performance of max setting is surface dependent. Refer to resolution table in CPI\_SET0.

<b>MOTCONFIG1</b>			Address: 0xBF				Type: OTP	
Access: Read/Write			Reset Value: 0x00					
<b>Bit</b>	7	6	5	4	3	2	1	0
<b>Field</b>	Reserved	Reserved	Reserved	Reserved	Reserved	Reserved	MF <sub>1</sub>	MF <sub>0</sub>

Data Type: Bit field

USAGE: This register allows configuration of USB motion reporting format. 12-bit or 16-bit is the recommended motion reporting format to achieve the optimum performance of the sensor. 8-bit is the optional setting for the system supporting 8-bit motion reporting only and it will have trade off on speed performance.

Field Name	Description
MF <sub>1-0</sub>	Sets USB motion reporting format <b>00 = 12-bit</b> 01 = 8-bit 10 = 16-bit 11 = Reserved

**ROTATION**

Access: Read/Write

Address: 0xC0

Reset Value: 0x07

Type: OTP

Bit	7	6	5	4	3	2	1	0
Field	Reserved	Reserved	Reserved	Reserved	Reserved	SWAP_XY	INV_X	INV_Y

Data Type: Bit field

USAGE: This register can be used to re-orientate the sensor motion reporting direction. The SWAP\_XY operation is always performed before INV\_X and INV\_Y inversion operations.

Field Name	Description
SWAP_XY	1 = Swap X and Y axis motion data report direction
INV_X	1 = Invert X axis motion data report direction
INV_Y	1 = Invert Y axis motion data report direction

Rotation	SWAP	INV_X	INV_Y
0	1	1	1
90	0	0	1
180	1	0	0
270	0	1	0

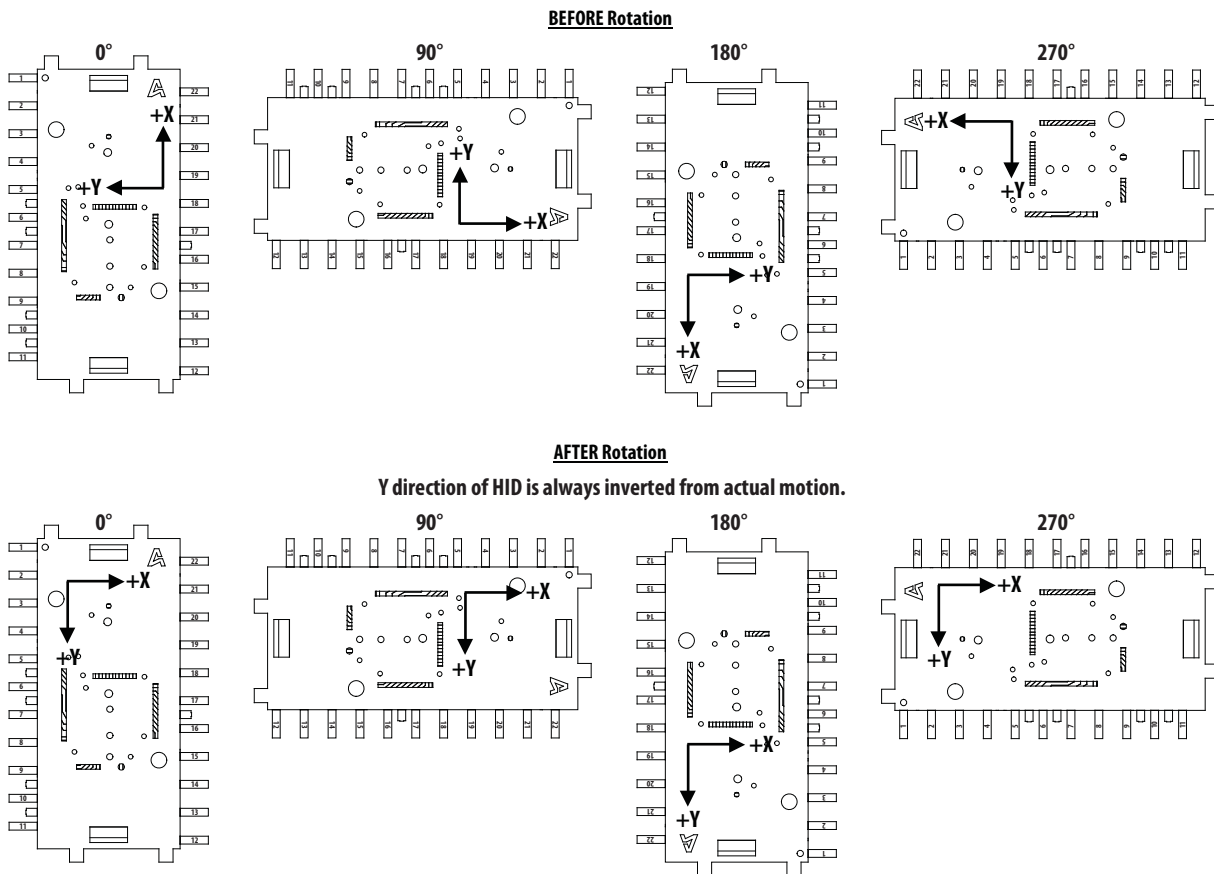

Figure 29. XY Motion Reporting Direction when Lens is attached on the Sensor

**DEVCONFIG**

Access: Read/Write

Address: 0xC1  
Reset Value: 0x00

Type: OTP

<b>Bit</b>	7	6	5	4	3	2	1	0
<b>Field</b>	KM <sub>1</sub>	KM <sub>0</sub>	OTF <sub>1</sub>	OTF <sub>0</sub>	0	0	0	0

Data Type: Bit field

USAGE: This register is used to enable the OTF resolution and KeyMap (KM) modes in the OTP. Refer to Table 4 on OTF Resolution and KeyMap Mode Configurations for details.

<b>Field Name</b>	<b>Description</b>
OTF <sub>1-0</sub>	Set OTF mode. <b>00 / 11 = Disabled</b> 10 / 01 = Enabled
KM <sub>1-0</sub>	KM mode <b>00 / 11 = Disabled</b> 10 / 01 = Enabled

**CODEA\_KEY1**

Access: Read/Write

Address: 0xC2  
Reset Value: 0x00

Type: OTP

Bit	7	6	5	4	3	2	1	0
Field	R-Gui	R-Alt	R-Shift	R-Ctrl	L-Gui	L-Alt	L-Shift	L-Ctrl

Data Type: Bit field

USAGE: This register is used together with CODEA\_KEY2 register to form CodeA for KM1 output. It is the KeyMap modifier key setting.

**CodeA = CODEA\_KEY1 + CODEA\_KEY2**

For 3D flip application, CodeA = Alt + Tab

CODEA\_KEY1 = 0x40 (R-Alt = 1) or 0x04 (L-Alt = 1)

CODEA\_KEY2 = 0x2B (Tab key)

Field Name	Description
R-Gui	Microsoft logo GUI key on the right side of keyboard <b>0 = Disabled</b> 1 = Enabled
R-Alt	Alt key on the right side of keyboard <b>0 = Disabled</b> 1 = Enabled
R-Shift	Shift key on the right side of keyboard <b>0 = Disabled</b> 1 = Enabled
R-Ctrl	Ctrl key on the right side of keyboard <b>0 = Disabled</b> 1 = Enabled
L-Gui	Microsoft logo GUI on the left side of keyboard <b>0 = Disabled</b> 1 = Enabled
R-Alt	Alt key on the left side of keyboard <b>0 = Disabled</b> 1 = Enabled
R-Shift	Shift key on the left side of keyboard <b>0 = Disabled</b> 1 = Enabled
R-Ctrl	Ctrl key on the left side of keyboard <b>0 = Disabled</b> 1 = Enabled

**CODEB\_KEY1**

Access: Read/Write

Address: 0xC3

Reset Value: 0x00

Type: OTP

Bit	7	6	5	4	3	2	1	0
Field	R-Gui	R-Alt	R-Shift	R-Ctrl	L-Gui	L-Alt	L-Shift	L-Ctrl

Data Type: Bit field

USAGE: This register is used together with CODEB\_KEY2 register to form CodeB for KM2 output. It is the KeyMap modifier key setting.

**CodeB = CODEB\_KEY1 + CODEB\_KEY2**

For Windows Security Logon/Logout application, CodeB = Alt + Ctrl + Del

CODEB\_KEY1 = 0x05 (L-Alt = 1, L-Ctrl = 1)

CODEB\_KEY2 = 0x4C (Del key)

Field Name	Description
R-Gui	Microsoft logo GUI key on the right side of keyboard <b>0 = Disabled</b> 1 = Enabled
R-Alt	Alt key on the right side of keyboard <b>0 = Disabled</b> 1 = Enabled
R-Shift	Shift key on the right side of keyboard <b>0 = Disabled</b> 1 = Enabled
R-Ctrl	Ctrl key on the right side of keyboard <b>0 = Disabled</b> 1 = Enabled
L-Gui	Microsoft logo GUI on the left side of keyboard <b>0 = Disabled</b> 1 = Enabled
R-Alt	Alt key on the left side of keyboard <b>0 = Disabled</b> 1 = Enabled
R-Shift	Shift key on the left side of keyboard <b>0 = Disabled</b> 1 = Enabled
R-Ctrl	Ctrl key on the left side of keyboard <b>0 = Disabled</b> 1 = Enabled

<b>CODEA_KEY2</b>		Address: 0xC4				Type: OTP			
Access: Read/Write		Reset Value: 0x00							
<b>Bit</b>	7	6	5	4	3	2	1	0	
<b>Field</b>	SC_A7	SC_A6	SC_A5	SC_A4	SC_A3	SC_A2	SC_A1	SC_A0	

Data Type: 8-Bit number

USAGE: This register is used together with CODEA\_KEY1 register to form CodeA for KM1 output. Any keyboard key scan codes listed in Keyboard Scan Code Specification Windows Platform Design Notes can be used but only limited to one scan code.

**CodeA = CODEA\_KEY1 + CODEA\_KEY2**

For 3D flip application, CodeA = Alt + Tab

CODEA\_KEY1 = 0x40 (R-Alt = 1) or 0x04 (L-Alt = 1)

CODEA\_KEY2 = 0x2B (Tab key)

<b>CODEB_KEY2</b>		Address: 0xC5				Type: OTP			
Access: Read/Write		Reset Value: 0x00							
<b>Bit</b>	7	6	5	4	3	2	1	0	
<b>Field</b>	SC_A7	SC_A6	SC_A5	SC_A4	SC_A3	SC_A2	SC_A1	SC_A0	

Data Type: 8-Bit number

USAGE: This register is used together with CODEA\_KEY1 register to form CodeA for KM2 output. Any keyboard key scan codes listed in Keyboard Scan Code Specification Windows Platform Design Notes can be used but only limited to one scan code.

**CodeB = CODEB\_KEY1 + CODEB\_KEY2**

For Windows Security Logon/Logout application, CodeB = Alt + Ctrl + Del

CODEB\_KEY1 = 0x05 (L-Alt = 1, L-Ctrl = 1)

CODEB\_KEY2 = 0x4C (Del key)

<b>LONGPRESS</b>		Address: 0xC6				Type: OTP			
Access: Read/Write		Reset Value: 0x10							
<b>Bit</b>	7	6	5	4	3	2	1	0	
<b>Field</b>	L_Press7	L_Press6	L_Press5	L_Press4	L_Press3	L_Press2	L_Press1	L_Press0	

Data Type: 8-Bit number

USAGE: This register is used to set the button press duration for OTF\_L. The press duration is range from 16ms to 4s. Each bit step change is 16ms.



<b>TW_CONFIG</b>			Address: 0xC7				Type: OTP		
Access: Read/Write			Reset Value: 0x00						
<b>Bit</b>	7	6	5	4	3	2	1	0	
<b>Field</b>	Reserved	Reserved	Reserved	Reserved	Reserved	Reserved	Reserved	TW_NEN	

Data Type: Bit field

USAGE: This register is used to set the Tilt Wheel mode for horizontal scrolling.

Field Name	Description
TW_NEN	Set Tilt Wheel mode <b>0 = Enabled</b> 1 = Disabled

<b>PID0</b>			Address: 0xC8				Type: OTP		
Access: Read/Write			Reset Value: 0x16						
<b>Bit</b>	7	6	5	4	3	2	1	0	
<b>Field</b>	PID <sub>7</sub>	PID <sub>6</sub>	PID <sub>5</sub>	PID <sub>4</sub>	PID <sub>3</sub>	PID <sub>2</sub>	PID <sub>1</sub>	PID <sub>0</sub>	

<b>PID1</b>			Address: 0xC9				Type: OTP		
Access: Read/Write			Reset Value: 0x07						
<b>Bit</b>	7	6	5	4	3	2	1	0	
<b>Field</b>	PID <sub>15</sub>	PID <sub>14</sub>	PID <sub>13</sub>	PID <sub>12</sub>	PID <sub>11</sub>	PID <sub>10</sub>	PID <sub>9</sub>	PID <sub>8</sub>	

Data Type: 16-Bit number

USAGE: These registers are used to customize device USB PID. **Default is Avago's PID = 0x0716.**

<b>VID0</b>			Address: 0xCA				Type: OTP		
Access: Read/Write			Reset Value: 0x2F						
<b>Bit</b>	7	6	5	4	3	2	1	0	
<b>Field</b>	VID <sub>7</sub>	VID <sub>6</sub>	VID <sub>5</sub>	VID <sub>4</sub>	VID <sub>3</sub>	VID <sub>2</sub>	VID <sub>1</sub>	VID <sub>0</sub>	

<b>VID1</b>			Address: 0xCB				Type: OTP		
Access: Read/Write			Reset Value: 0x19						
<b>Bit</b>	7	6	5	4	3	2	1	0	
<b>Field</b>	VID <sub>15</sub>	VID <sub>14</sub>	VID <sub>13</sub>	VID <sub>12</sub>	VID <sub>11</sub>	VID <sub>10</sub>	VID <sub>9</sub>	VID <sub>8</sub>	

Data Type: 16-Bit number

USAGE: These registers are used to customize device VID. **Default is Avago's VID = 0x192F.**

<b>MSTR_LEN</b>		Address: 0xCC				Type: OTP			
Access: Read/Write		Reset Value: 0x0C							
<b>Bit</b>	7	6	5	4	3	2	1	0	
<b>Field</b>	MSTR_LEN <sub>7</sub>	MSTR_LEN <sub>6</sub>	MSTR_LEN <sub>5</sub>	MSTR_LEN <sub>4</sub>	MSTR_LEN <sub>3</sub>	MSTR_LEN <sub>2</sub>	MSTR_LEN <sub>1</sub>	MSTR_LEN <sub>0</sub>	

Data Type: 8-bit number.

USAGE: Specifies the manufacturing string description length in bytes inclusive (plus 1 for descriptor type). One character = 2 bytes.

Number of bytes = 1 MSTR\_LEN + 2 \*(MFR\_STR characters) + 1 descriptor type

**Default: Number of bytes = 1 + (2 \* 5) + 1 = 12 = 0x0C**

<b>MFR_STR0 to MFR_STR11</b>		Address: 0xCD to 0xD8				Type: OTP			
Access: Read/Write		Reset Value: "Avago"							
<b>Bit</b>	7	6	5	4	3	2	1	0	
<b>Field</b>	MFR_STR <sub>7</sub>	MFR_STR <sub>6</sub>	MFR_STR <sub>5</sub>	MFR_STR <sub>4</sub>	MFR_STR <sub>3</sub>	MFR_STR <sub>2</sub>	MFR_STR <sub>1</sub>	MFR_STR <sub>0</sub>	

Data Type: 12 bytes number

USAGE: These registers allow maximum of 11 characters in ASCII. Default = "Avago"

Register Name	Address	Default Value	
		ASCII	Character
MFR_STR0	0xCD	0x41	"A"
MFR_STR1	0xCE	0x76	"v"
MFR_STR2	0xCF	0x61	"a"
MFR_STR3	0xD0	0x67	"g"
MFR_STR4	0xD1	0x6F	"o"
MFR_STR5	0xD2	0x00	Null
MFR_STR6	0xD3	0x00	Null
MFR_STR7	0xD4	0x00	Null
MFR_STR8	0xD5	0x00	Null
MFR_STR9	0xD6	0x00	Null
MFR_STR10	0xD7	0x00	Null
MFR_STR11	0xD8	0x00	Null

<b>PSTR_LEN</b>		Address: 0xD9				Type: OTP			
Access: Read/Write		Reset Value: 0x34							
<b>Bit</b>	7	6	5	4	3	2	1	0	
<b>Field</b>	PSTR_LEN <sub>7</sub>	PSTR_LEN <sub>6</sub>	PSTR_LEN <sub>5</sub>	PSTR_LEN <sub>4</sub>	PSTR_LEN <sub>3</sub>	PSTR_LEN <sub>2</sub>	PSTR_LEN <sub>1</sub>	PSTR_LEN <sub>0</sub>	

Data Type: 8-bit number.

USAGE: Specifies the product string description length in bytes inclusive (plus 1 for descriptor type). One character = 2 bytes.

Number of bytes = 1 PSTR\_LEN + 2 \*(PROD\_STR characters) + 1 descriptor type

**Default: Number of bytes = 1 + (2 \* 25) + 1 = 52 = 0x34**

<b>PROD_STR0 to PROD_STR28</b>		Address: 0xDA to 0xF5				Type: OTP			
Access: Read/Write		Reset Value: "USB LaserStream(TM) Mouse"							
<b>Bit</b>	7	6	5	4	3	2	1	0	
<b>Field</b>	PROD_STR <sub>7</sub>	PROD_STR <sub>6</sub>	PROD_STR <sub>5</sub>	PROD_STR <sub>4</sub>	PROD_STR <sub>3</sub>	PROD_STR <sub>2</sub>	PROD_STR <sub>1</sub>	PROD_STR <sub>0</sub>	

Data Type: 28 bytes number

USAGE: These registers allow maximum of 28 characters in ASCII. Default = "USB LaserStream(TM) Mouse"

Register Name	Address	Default Value		Register Name	Address	Default Value	
		ASCII	Character			ASCII	Character
PROD_STR0	0xDA	0x55	"U"	PROD_STR14	0xE8	0x6D	"m"
PROD_STR1	0xDB	0x53	"S"	PROD_STR15	0xE9	0x28	"("
PROD_STR2	0xDC	0x42	"B"	PROD_STR16	0xEA	0x54	"T"
PROD_STR3	0xDD	0x20	" "	PROD_STR17	0xEB	0x4D	"M"
PROD_STR4	0xDE	0x4C	"L"	PROD_STR18	0xEC	0x29	")"
PROD_STR5	0xDF	0x61	"a"	PROD_STR19	0xED	0x20	" "
PROD_STR6	0xE0	0x73	"s"	PROD_STR20	0xEE	0x4D	"M"
PROD_STR7	0xE1	0x65	"e"	PROD_STR21	0xEF	0x6F	"o"
PROD_STR8	0xE2	0x72	"r"	PROD_STR22	0xF0	0x75	"u"
PROD_STR9	0xE3	0x53	"S"	PROD_STR23	0xF1	0x73	"s"
PROD_STR10	0xE4	0x74	"t"	PROD_STR24	0xF2	0x65	"e"
PROD_STR11	0xE5	0x72	"r"	PROD_STR25	0xF3	0x00	Null
PROD_STR12	0xE6	0x65	"e"	PROD_STR26	0xF4	0x00	Null
PROD_STR13	0xE7	0x61	"a"	PROD_STR27	0xF5	0x00	Null

<b>DEV_NUM0</b>		Address: 0xF6				Type: OTP		
Access: Read/Write		Reset Value: 0x00						
<b>Bit</b>	7	6	5	4	3	2	1	0
<b>Field</b>	DEV <sub>7</sub>	DEV <sub>6</sub>	DEV <sub>5</sub>	DEV <sub>4</sub>	DEV <sub>3</sub>	DEV <sub>2</sub>	DEV <sub>1</sub>	DEV <sub>0</sub>

<b>DEV_NUM1</b>		Address: 0xF7				Type: OTP		
Access: Read/Write		Reset Value: 0x00						
<b>Bit</b>	7	6	5	4	3	2	1	0
<b>Field</b>	DEV <sub>15</sub>	DEV <sub>14</sub>	DEV <sub>13</sub>	DEV <sub>12</sub>	DEV <sub>11</sub>	DEV <sub>10</sub>	DEV <sub>9</sub>	DEV <sub>8</sub>

Data Type: 16-Bit number

USAGE: These registers are used to customize device number, which is optional to be assigned by manufacturer.

<b>OTPLOCK2</b>		Address: 0xFA				Type: OTP		
Access: Read/Write		Reset Value: 0x00						
<b>Bit</b>	7	6	5	4	3	2	1	0
<b>Field</b>	OTPLOCK <sub>27</sub>	OTPLOCK <sub>26</sub>	OTPLOCK <sub>25</sub>	OTPLOCK <sub>24</sub>	OTPLOCK <sub>23</sub>	OTPLOCK <sub>22</sub>	OTPLOCK <sub>21</sub>	OTPLOCK <sub>20</sub>

Data Type: 8-bit field.

USAGE: Must write 0xFF in this register to lock the OTP configuration. Warning: Other values will cause the sensor to be malfunction.

For product information and a complete list of distributors, please go to our web site: [www.avagotech.com](http://www.avagotech.com)