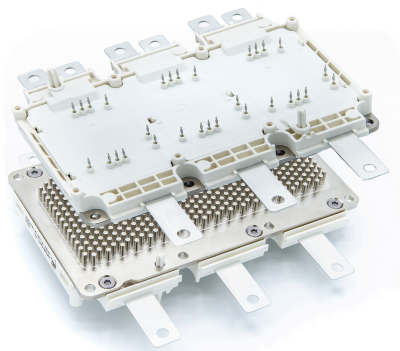
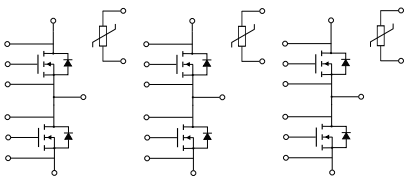


## Automotive-grade ACEPACK DRIVE power module, sixpack topology 750 V, 1.2 mΩ typ. SiC MOSFET gen.3 based



ACEPACK DRIVE



### Features

- AQC 324 qualified 
- 750 V blocking voltage
- 1.2 mΩ of typical  $R_{DS(on)}$
- Maximum operative junction temperature  $T_J = 175\text{ °C}$
- Very low switching energy
- Low inductive compact design for an higher power density
- $\text{Si}_3\text{N}_4$  AMB substrate to improve thermal performance
- SiC Power MOSFET chip sintered to substrate for improved lifetime
- 4.2 kV DC 1 s insulation
- Directly liquid cooled base plate with pin-fins
- Three integrated NTC temperature sensors
- Long AC bus bar compatible with phase current sense

### Application

- Main inverter (electric traction)

### Description

The ACEPACK DRIVE is a compact sixpack module optimized for hybrid and electric vehicles traction inverter. This power module features switches based on silicon carbide Power MOSFET 3<sup>rd</sup> generation, are characterized by very low  $R_{DS(on)}$ , very limited switching losses and outstanding performances in synchronous rectification working mode. This will ensure superb efficiency in final application, saving battery recharging cycles.

A copper base plate with pin-fin base structure make direct fluid cooling available for this power module minimizing thermal resistance.

A dedicated pin-out has been developed to get the best switching performances and press-fit pins will ensure optimal connection with driving board.



#### Product status link

[ADP61075W3-L](#)

#### Product summary

Order code	ADP61075W3-L
Marking	ADP61075W3-L
Package	ACEPACK DRIVE
Leads type	Press-fit
Packing	Tray

# 1 Electrical ratings

**Table 1. Absolute maximum ratings of each switch**

Symbol	Parameter	Value	Unit
$V_{(BR)DSS}$	Drain-source breakdown voltage	750	V
$V_{GS}$	Gate-source voltage	-10 to 22	V
	Gate-source voltage (recommended operating values)	-5 to 18	
$I_D$	Continuous drain current at $T_F = 75\text{ °C}$ (refer to $T_J \text{ max} = 175\text{ °C}$ , $V_{GS} = 18\text{ V}$ )	623	A
$I_{DM}^{(1)}$	Repetitive peak drain current	1300	A
$P_{TOT}$	Total power dissipation at $T_F = 75\text{ °C}$ (refer to $T_J \text{ max} = 175\text{ °C}$ , $V_{GS} = 18\text{ V}$ )	869	W
$T_J$	Operating junction temperature range under switching conditions	-40 to 175 <sup>(2)</sup>	°C

1. Pulse width limited by maximum junction temperature.
2. Maximum baseplate temperature has to be always limited to 125 °C.

**Table 2. Thermal data of each switch**

Symbol	Parameter	Min.	Typ.	Max.	Unit
$R_{thJF}^{(1)}$	Thermal resistance, junction-to-fluid (flow rate = 10 LPM, $T_F = 75\text{ °C}$ , single switch)	-	0.105	-	°C/W

1. Simulated value considering 50% water/ 50% ethylene glycol cooling fluid. Refer to TN1412 "ACEPACK DRIVE assembly instructions" for water jacket design.

## 2 Electrical characteristics

$T_J = 25\text{ °C}$ , unless otherwise specified.

**Table 3. Electrical characteristics of each switch**

Symbol	Parameter	Test conditions	Min.	Typ.	Max.	Unit
$R_{DS(on)}^{(1)}$	Static drain-source on-resistance	$V_{GS} = 18\text{ V}$ , $I_D = 610\text{ A}$		1.20	1.60	mΩ
		$V_{GS} = 18\text{ V}$ , $I_D = 610\text{ A}$ , $T_J = 175\text{ °C}$		1.95		
		$V_{GS} = 18\text{ V}$ , $I_D = -610\text{ A}$		1.15		
		$V_{GS} = 18\text{ V}$ , $I_D = -610\text{ A}$ , $T_J = 175\text{ °C}$		1.85		
$V_{GS(th)}$	Gate threshold voltage	$V_{DS} = V_{GS}$ , $I_D = 50\text{ mA}$	1.9	3.1	4.4	V
$I_{DSS}$	Zero gate voltage drain current	$V_{GS} = 0\text{ V}$ , $V_{DS} = 750\text{ V}$			100	μA
		$V_{GS} = 0\text{ V}$ , $V_{DS} = 750\text{ V}$ , $T_J = 150\text{ °C}^{(2)}$			2	mA
$I_{GSS}$	Gate-body leakage current	$V_{DS} = 0\text{ V}$ , $V_{GS} = -10\text{ to }22\text{ V}$			±2	μA
$C_{iss}$	Input capacitance			36.07		nF
$C_{oss}$	Output capacitance	$V_{DS} = 400\text{ V}$ , $f = 1\text{ MHz}$ , $V_{GS} = 0\text{ V}$		2.85		nF
$C_{rss}$	Reverse transfer capacitance			0.21		nF
$Q_g$	Total gate charge	$V_{DS} = 400\text{ V}$ , $I_D = 610\text{ A}$ , $V_{GS} = -5\text{ V to }18\text{ V}$		1312		nC
$Q_{gs}$	Gate-source charge			430		nC
$Q_{gd}$	Gate-drain charge			368		nC

- $R_{DS(on)}$  is referred to switch level.
- Specified by design, not tested in production.

**Table 4. Switching energy of each switch**

Symbol	Parameter	Test conditions	Min.	Typ.	Max.	Unit
$E_{on}^{(1)}$	Turn-on switching energy	$V_{DD} = 400\text{ V}$ , $V_{GS} = -5\text{ to }18\text{ V}$ , $R_{G(on)} = 15\text{ Ω}$ , $di/dt_{on} = 3.0\text{ A/ns}$ , $I_D = 610\text{ A}$	-	36.8	-	mJ
		$V_{DD} = 400\text{ V}$ , $V_{GS} = -5\text{ to }18\text{ V}$ , $R_{G(on)} = 15\text{ Ω}$ , $di/dt_{on} = 3.8\text{ A/ns}$ , $I_D = 610\text{ A}$ , $T_J = 175\text{ °C}$	-	24.6	-	
$E_{off}$	Turn-off switching energy	$V_{DD} = 400\text{ V}$ , $V_{GS} = -5\text{ to }18\text{ V}$ , $R_{G(off)} = 8.2\text{ Ω}$ , $dV/dt_{off} = 3.2\text{ V/ns}$ , $I_D = 610\text{ A}$	-	32.6	-	mJ
		$V_{DD} = 400\text{ V}$ , $V_{GS} = -5\text{ to }18\text{ V}$ , $R_{G(off)} = 8.2\text{ Ω}$ , $dV/dt_{off} = 3.8\text{ V/ns}$ , $I_D = 610\text{ A}$ , $T_J = 175\text{ °C}$	-	28.5	-	

- Using active Miller clamp circuit.

**Table 5. Source-drain diode characteristics of each switch**

Symbol	Parameter	Test conditions	Min.	Typ.	Max.	Unit
$V_{SD}$	Forward on voltage drop	$V_{GS} = -5\text{ V}$ , $I_D = 610\text{ A}$	-	4.3	-	V
$t_{rr}$	Reverse recovery time	$V_{DD} = 400\text{ V}$ , $V_{GS} = -5\text{ V to } 18\text{ V}$ , $R_{G(on)} = 15\ \Omega$ , $di/dt_{on} = 3.0\text{ A/ns}$ , $I_D = 610\text{ A}$	-	42	-	ns
$Q_{rr}$	Reverse recovery charge		-	2.6	-	$\mu\text{C}$
$I_{RRM}$	Reverse recovery current		-	110	-	A
$E_{rec}$	Reverse recovery energy		-	0.47	-	mJ
$t_{rr}$	Reverse recovery time		-	50	-	ns
$Q_{rr}$	Reverse recovery charge	$V_{DD} = 400\text{ V}$ , $V_{GS} = -5\text{ to } 18\text{ V}$ , $R_{G(on)} = 15\ \Omega$ , $di/dt_{on} = 3.8\text{ A/ns}$ , $I_D = 610\text{ A}$ , $T_J = 175\text{ }^\circ\text{C}$	-	4.8	-	$\mu\text{C}$
$I_{RRM}$	Reverse recovery current		-	168	-	A
$E_{rec}$	Reverse recovery energy		-	1.1	-	mJ

Note: Values are calculated taking in account an active Miller clamp circuit.

### 3 NTC

**Table 6. Absolute maximum ratings for NTC temperature sensor, considered as standalone**

Symbol	Parameter	Test condition	Min.	Typ.	Max.	Unit
R <sub>25</sub>	Rated resistance	T = 25 °C		5.0		kΩ
R <sub>100</sub>	Rated resistance	T = 100 °C		493		Ω
ΔR/R	Deviation of R <sub>100</sub>		-5		+5	%
B <sub>25/50</sub>	B-constant			3375		K
B <sub>25/80</sub>				3411		K

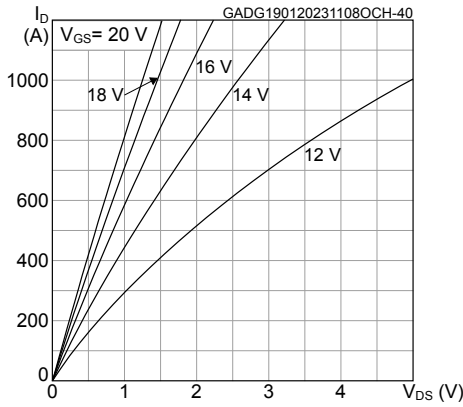
## 4 ACEPACK DRIVE power module details

**Table 7. Ratings for module**

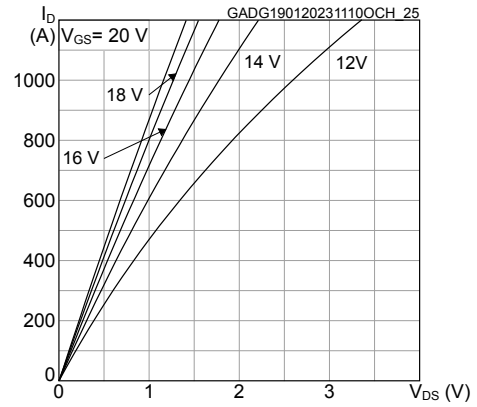
Symbol	Parameter		Value	Unit
$V_{ISO}$	Isolation voltage (f = 0 Hz, t = 1 s)		4.2	kV
	Internal isolation (class 1, IEC 61140)		$Si_3N_4$	
	Baseplate module material		Ni plated, Cu baseplate	
$d_{creep}$	Creepage distance	Terminal to heat sink	9.0	mm
		Terminal to terminal	9.0	
$d_{clear}$	Clearance distance	Terminal to heat sink	4.5	mm
		Terminal to terminal	4.5	
CTI	Comparative tracking index		>200	V
$L_s$	Typical stray inductance drain to source module loop		10	nH
$R_s$	Typical module lead resistance, terminals to chip		0.5	m $\Omega$
$T_{stg}$	Storage temperature range		-40 to 125	$^{\circ}C$

## 5 Electrical characteristics (curves)

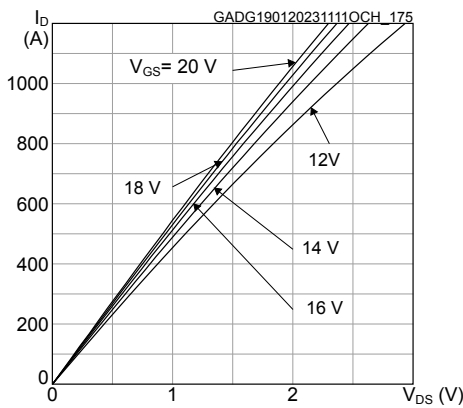
**Figure 1. Typical output characteristics ( $T_J = -40\text{ }^\circ\text{C}$ )**



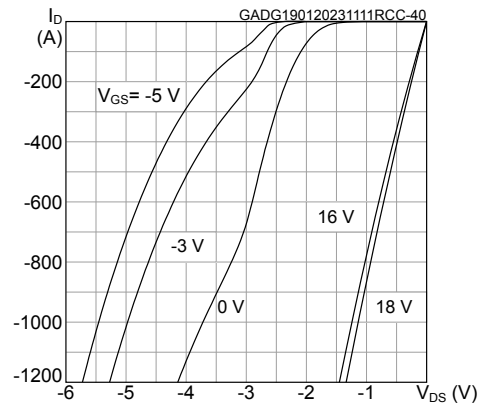
**Figure 2. Typical output characteristics ( $T_J = 25\text{ }^\circ\text{C}$ )**



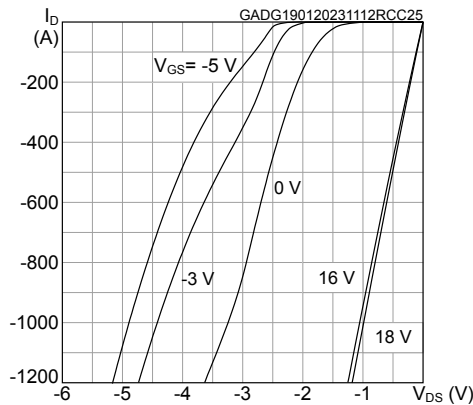
**Figure 3. Typical output characteristics ( $T_J = 175\text{ }^\circ\text{C}$ )**



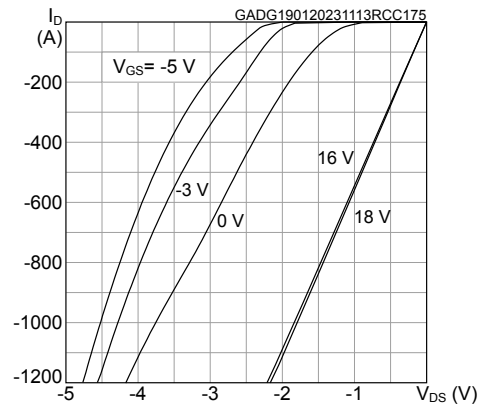
**Figure 4. Typical reverse conduction characteristics ( $T_J = -40\text{ }^\circ\text{C}$ )**



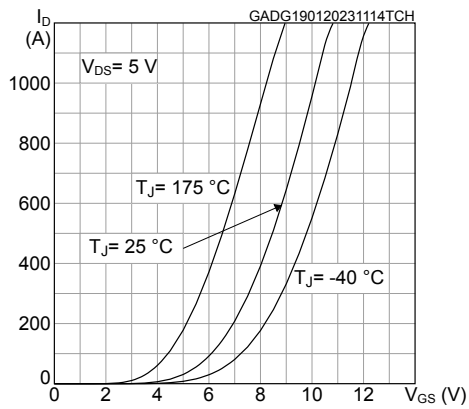
**Figure 5. Typical reverse conduction characteristics ( $T_J = 25\text{ }^\circ\text{C}$ )**



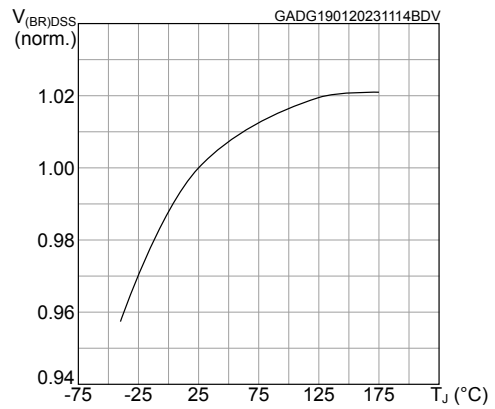
**Figure 6. Typical reverse conduction characteristics ( $T_J = 175\text{ }^\circ\text{C}$ )**



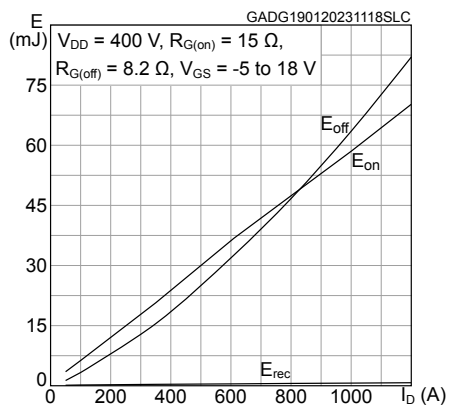
**Figure 7. Typical transfer characteristics**



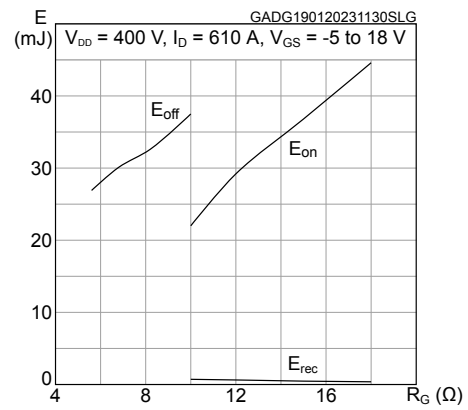
**Figure 8. Normalized breakdown voltage vs temperature**



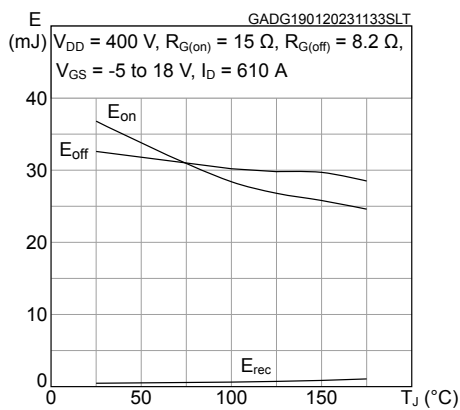
**Figure 9. Typical switching energy vs drain current**



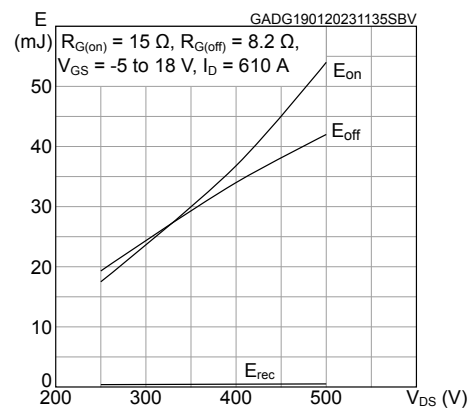
**Figure 10. Typical switching energy vs gate resistance**



**Figure 11. Typical switching energy vs temperature**

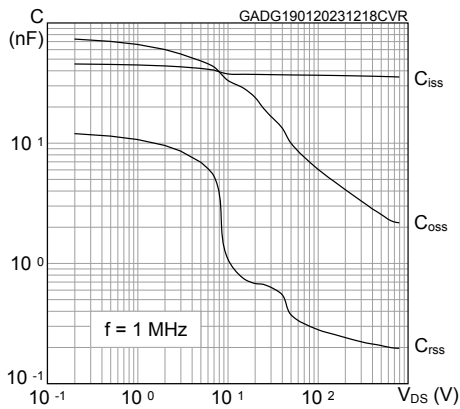


**Figure 12. Typical switching energy vs bus voltage**

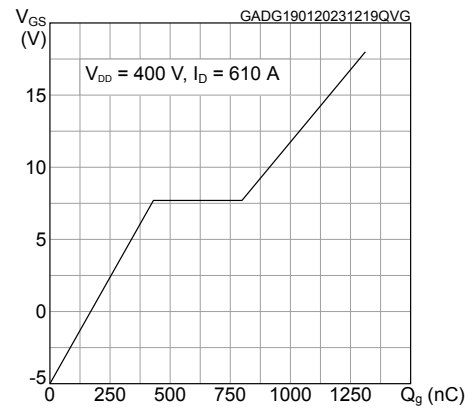




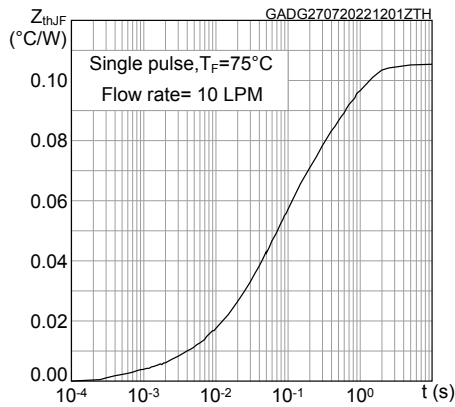
**Figure 13. Typical capacitance characteristics**



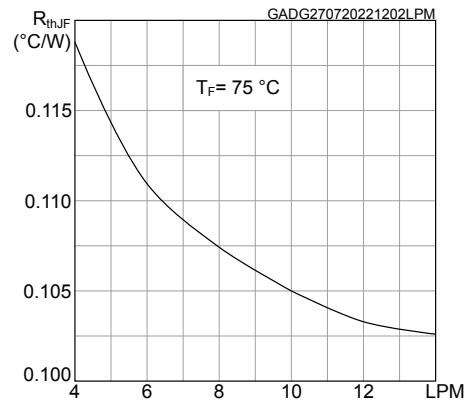
**Figure 14. Typical gate charge characteristics**



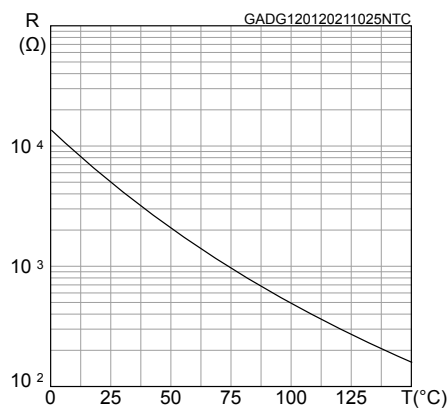
**Figure 15. Typical transient thermal impedance**



**Figure 16. Typical thermal resistance vs flow rate**



**Figure 17. Typical NTC resistance vs temperature**



## 6 Topology, pin description and positioning

Figure 18. Topology, pin description and positioning

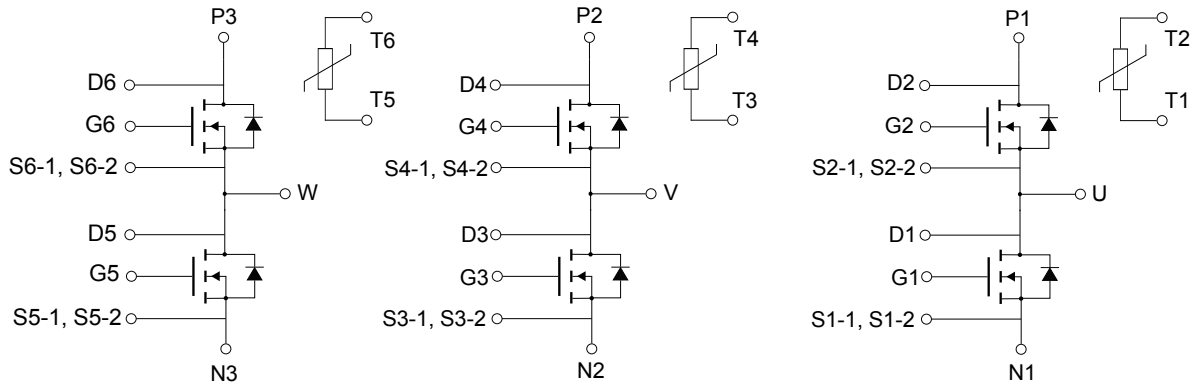
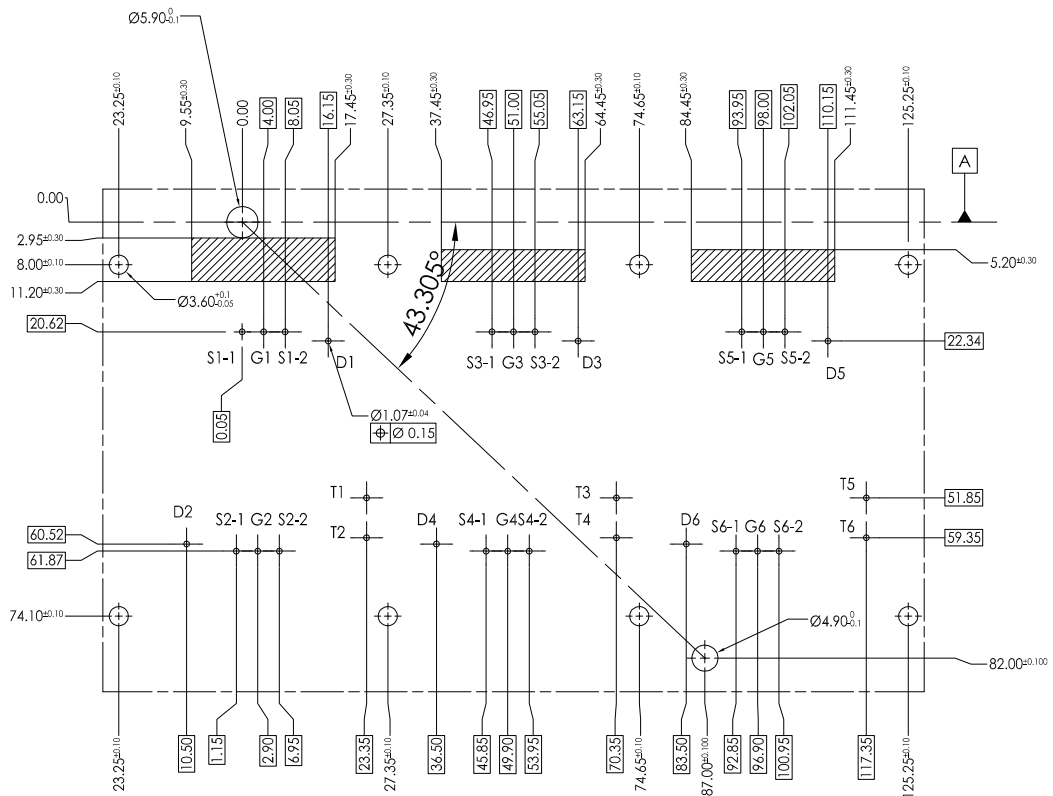
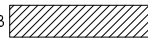


Figure 19. ACEPACK DRIVE PCB drawing (dimensions are in mm.)



PCB thickness 1.60 mm +/-0.16

Forbidden area for passive components between Cover and PCB



DM00518615\_PCB\_Rev6

---

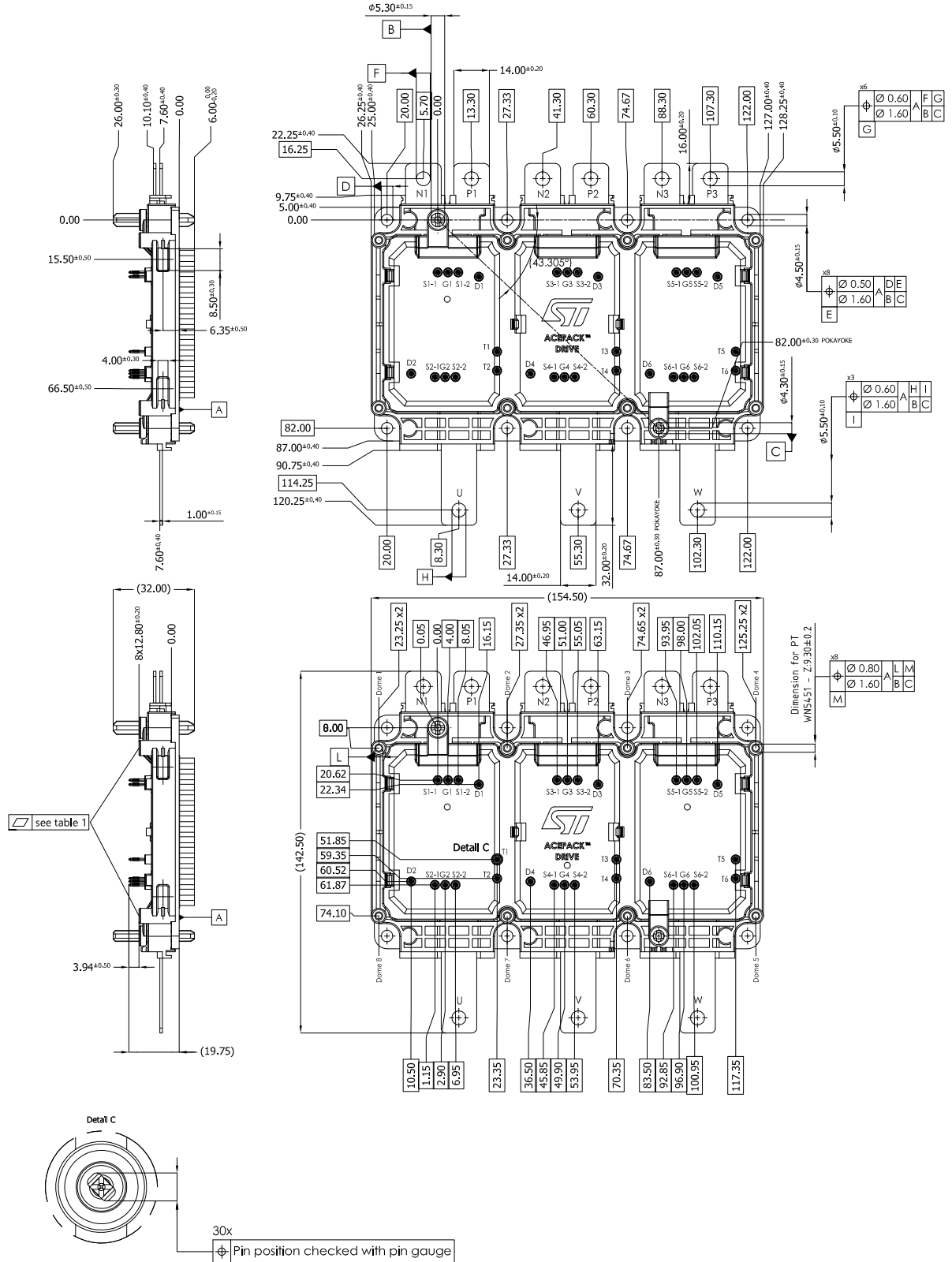
## 7 Package information

---

In order to meet environmental requirements, ST offers these devices in different grades of **ECOPACK** packages, depending on their level of environmental compliance. ECOPACK specifications, grade definitions and product status are available at: [www.st.com](http://www.st.com). ECOPACK is an ST trademark.

## 7.1 ACEPACK DRIVE package information

Figure 20. ACEPACK DRIVE long tab package outline (dimensions are in mm.)



## Revision history

**Table 8. Document revision history**

Date	Revision	Changes
14-Sep-2021	1	First release.
08-May-2023	2	Modified Section Features. Modified the entire Section 1 Electrical ratings. Added Section 5 Electrical characteristics (curves). Minor text changes.

---

## Contents

<b>1</b>	<b>Electrical ratings</b> .....	<b>2</b>
<b>2</b>	<b>Electrical characteristics</b> .....	<b>3</b>
<b>3</b>	<b>NTC</b> .....	<b>5</b>
<b>4</b>	<b>ACEPACK DRIVE power module details</b> .....	<b>6</b>
<b>5</b>	<b>Electrical characteristics (curves)</b> .....	<b>7</b>
<b>6</b>	<b>Topology, pin description and positioning</b> .....	<b>10</b>
<b>7</b>	<b>Package information</b> .....	<b>11</b>
	<b>7.1</b> ACEPACK DRIVE package information .....	<b>12</b>
	<b>Revision history</b> .....	<b>13</b>

**IMPORTANT NOTICE – READ CAREFULLY**

STMicroelectronics NV and its subsidiaries (“ST”) reserve the right to make changes, corrections, enhancements, modifications, and improvements to ST products and/or to this document at any time without notice. Purchasers should obtain the latest relevant information on ST products before placing orders. ST products are sold pursuant to ST’s terms and conditions of sale in place at the time of order acknowledgment.

Purchasers are solely responsible for the choice, selection, and use of ST products and ST assumes no liability for application assistance or the design of purchasers’ products.

No license, express or implied, to any intellectual property right is granted by ST herein.

Resale of ST products with provisions different from the information set forth herein shall void any warranty granted by ST for such product.

ST and the ST logo are trademarks of ST. For additional information about ST trademarks, refer to [www.st.com/trademarks](http://www.st.com/trademarks). All other product or service names are the property of their respective owners.

Information in this document supersedes and replaces information previously supplied in any prior versions of this document.

© 2023 STMicroelectronics – All rights reserved