

FEATURES

- Ultralow noise, low power current amplifier**
- 80 fA/ $\sqrt{\text{Hz}}$ (typical) noise floor**
- 140 μA (typical) of supply current when active ($E_E = 0 \mu\text{W}/\text{cm}^2$)**
- 100 nA (typical) of supply current in standby**
- Flexible output configuration**
- Optimized for pulsed systems**
- Nominal linear output: 240 μA**
- Space-saving 2 mm \times 2 mm LFCSP package**

APPLICATIONS

- Photoplethysmography**
- Photodiode measurements**
- Small current pulsed amperometry**
- Any application requiring the ultralow noise amplification of small currents**

GENERAL DESCRIPTION

The [ADPD2210](#) is a low noise current amplifier designed to allow the use of smaller photodiodes by amplifying sensor signal currents by a factor of 24 while adding minimal noise. This amplification provides the system sensitivity of a large photodiode with the benefits of a smaller photodiode. A minimum linearity of 60 dB allows accurate extraction of very small time variant signals on top of large dc or low frequency offsets.

The [ADPD2210](#) is optimized for pulse mode applications such as wrist worn heart rate monitoring (HRM) or finger worn pulse oximeter oxygen saturation (SpO_2), where low power consumption and rejection of ambient light is critical. In photodiode applications, the [ADPD2210](#) holds the sensor input to within ± 5 mV (typical) of the reference terminal, providing near zero-bias voltage and allowing minimal dark current and shot noise limited performance.

FUNCTIONAL BLOCK DIAGRAM

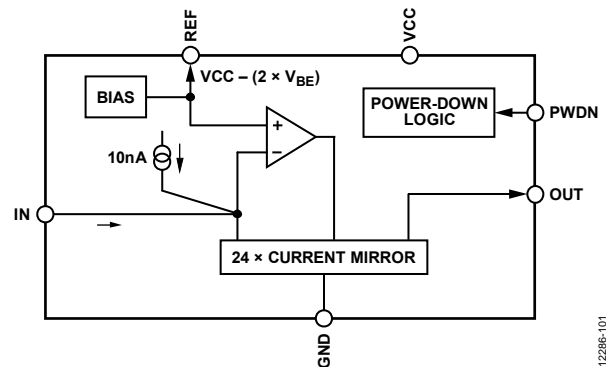

Figure 1.

12286-101

The [ADPD2210](#) is designed for applications where power conservation is critical. The [ADPD2210](#) uses very little power, typically 140 μA with no input to 954 μA at full scale. A power-down pin places the [ADPD2210](#) in standby when sensing is inactive. This mode adds critical time for battery-powered monitoring and can reduce battery costs in disposable applications.

Using the [ADPD2210](#) to provide sensor site amplification reduces the effect of electromagnetic interference (EMI) in low level wired interfaces, providing improved signal-to-noise ratio (SNR) and rejection of interferer signals from nearby equipment. The combination of low power, high SNR, and EMI immunity enables low power system solutions not possible with traditional small current sensors, such as photodiodes plus transimpedance amplifiers (TIAs).

ADPD2210* Product Page Quick Links

Last Content Update: 11/01/2016

[Comparable Parts](#)

View a parametric search of comparable parts

[Evaluation Kits](#)

- [ADPD2210 Evaluation Board](#)

[Documentation](#)

Data Sheet

- [ADPD2210: Ultralow Noise, Low Power Current Amplifier Data Sheet](#)

[Design Resources](#)

- [ADPD2210 Material Declaration](#)
- [PCN-PDN Information](#)
- [Quality And Reliability](#)
- [Symbols and Footprints](#)

[Discussions](#)

View all ADPD2210 EngineerZone Discussions

[Sample and Buy](#)

Visit the product page to see pricing options

[Technical Support](#)

Submit a technical question or find your regional support number

TABLE OF CONTENTS

Features	1	Pulse Mode Operation.....	11
Applications.....	1	Applications Information	12
Functional Block Diagram	1	Powering the ADPD2210	12
General Description	1	Exposed Pad Connection	12
Revision History	2	Power-Down	12
Specifications.....	3	Reference Output.....	12
Absolute Maximum Ratings.....	4	Layout Considerations.....	12
Thermal Resistance	4	Output Configuration.....	12
ESD Caution.....	4	Accuracy in Clinical Applications.....	12
Pin Configuration and Function Descriptions.....	5	3-Wire Voltage Configuration	13
Typical Performance Characteristics	6	3-Wire Current Mode Configuration.....	13
Terminology	10	Evaluation Board	14
Theory of Operation	11	Outline Dimensions	15
Overview.....	11	Ordering Guide	15
Recommended Configuration.....	11		
Sensitivity and SNR.....	11		

REVISION HISTORY

12/15—Rev. 0 to Rev. A

Changes to Ordering Guide

10/15—Revision 0: Initial Version

SPECIFICATIONS

$V_{CC} = 3.3\text{ V}$ $T_A = 25^\circ\text{C}$, unless otherwise noted. N_{SHOT} is shot noise. E_E is irradiance.

Table 1.

Parameter	Symbol	Test Conditions/Comments	Min	Typ	Max	Unit
GAIN						
Current Gain	β_{TLA}	$V_{\text{BIAS}} = 0\text{ V}$	23.7	24.2	24.8	
DYNAMIC PERFORMANCE						
Power-Down Recovery Time	t_{RECOVER}	1% full-scale (FS) output 100 nA to 1 μA 1 μA to 10 μA		50 20		μs μs
Rise	t_{RISE}	10% to 90% FS (240 μA)		5		μs
Fall	t_{FALL}	90% to 10% FS (240 μA)		5		μs
Bandwidth		$I_{\text{IN}} = 100\text{ nA (dc), 100 nA (ac)}$ $I_{\text{IN}} = 1\text{ }\mu\text{A (dc), 100 nA (ac)}$		125 85		kHz kHz
INPUT						
Input Capacitance	$C_{\text{IN_MAX}}$			8		pF
Nominal Input Current	$I_{\text{IN_MAX}}$		10			μA
Input Offset Voltage	$V_{\text{IN_REF}}$			± 5		mV
Reference Voltage	REF			$V_{\text{CC}} - 1.2$		V
STATIC BIAS						
Input Referred	I_{SB}			10		nA
Output Referred	O_{SB}			240		nA
NOISE PERFORMANCE						
Current Noise Floor, Input Referred	I_{IN}	$I_{\text{IN}} < 10\text{ nA}$		80	150	$\text{fA}/\sqrt{\text{Hz}}$
Current Noise, Input Referred		$I_{\text{IN}} = 100\text{ nA}, 1.5 \times N_{\text{SHOT}}$ $I_{\text{IN}} = 1\text{ }\mu\text{A}, 1.15 \times N_{\text{SHOT}}$		260 740		$\text{fA}/\sqrt{\text{Hz}}$ $\text{fA}/\sqrt{\text{Hz}}$
POWER AND SUPPLY						
Supply Voltage	V_{CC}		1.8	3.3	5	V
Standby Current	I_{STANDBY}	$\text{PWDN} > V_{\text{IH}}$		100		nA
Power Supply Rejection Ratio	PSRR	$V_{\text{CC}} = 1.8\text{ V to } 5.0\text{ V}, E_E = 10\text{ }\mu\text{A}$		25		nA/V
Supply Current Floor	I_{FLOOR}	$I_{\text{IN}} = 0\text{ }\mu\text{A}$		140		μA
Supply Current	I_{SUPPLY}	$I_{\text{OUT}} = 10\text{ }\mu\text{A}$ $I_{\text{OUT}} = 240\text{ }\mu\text{A}, I_{\text{SUPPLY}} = I_{\text{FLOOR}} + (3.3 \times I_{\text{OUT}})$		167 954		μA μA
OUTPUT CHARACTERISTICS						
Maximum Output Voltage	$V_{\text{OUT_MAX}}$	$V_{\text{CC}} = 3.3\text{ V}, I_{\text{OUT}} = 240\text{ }\mu\text{A}$		$V_{\text{CC}} - 0.75$		V
Nominal Linear Output	$I_{\text{OUT_FS}}$	$V_{\text{CC}} = 3.3\text{ V}$ $V_{\text{CC}} = 1.8\text{ V}$		240 65		μA μA
Linearity		$TIA, V_{\text{BIAS}} = 0\text{ V}, R_{\text{FEEDBACK}} = 25\text{ k}\Omega$ $I_{\text{IN}} = 200\text{ nA to } 4\text{ }\mu\text{A}$ $I_{\text{IN}} = 200\text{ nA to } 10\text{ }\mu\text{A}$			0.1	% %
Resistor		$I_{\text{IN}} = 200\text{ nA to } 4\text{ }\mu\text{A}, R_{\text{LOAD}} = 5\text{ k}\Omega$		0.3		%
Peak Output Current	$I_{\text{OUT_PEAK}}$	$V_{\text{CC}} = 3.3\text{ V}$ $V_{\text{CC}} = 1.8\text{ V}$		300 65		μA μA
Output Capacitance	C_{OUT}	From OUT to GND		5		pF
Output Resistance	R_{OUT}	From OUT to GND		>5		G Ω
POWER-DOWN LOGIC						
Input Voltage						
High	V_{IH}		$V_{\text{CC}} - 0.2$			V
Low	V_{IL}				0.2	V
Leakage Current						
High	I_{IH}	$\text{PWDN} = 3.3\text{ V}$		0.2		nA
Low	I_{IL}	$\text{PWDN} = 0\text{ V}$		-8.5		μA

ABSOLUTE MAXIMUM RATINGS

Table 2.

Parameter	Rating
Supply Voltage, V_{CC}	6 V
Storage Temperature Range	-65°C to +150°C
Operating Ambient Temperature Range	-40°C to +85°C
Maximum Junction Temperature	150°C
Solder Reflow Temperature (<10 sec)	260°C
Current into IN Pin	1 mA

Stresses at or above those listed under Absolute Maximum Ratings may cause permanent damage to the product. This is a stress rating only; functional operation of the product at these or any other conditions above those indicated in the operational section of this specification is not implied. Operation beyond the maximum operating conditions for extended periods may affect product reliability.

THERMAL RESISTANCE

θ_{JA} is specified for the worst-case conditions, that is, a device soldered in a circuit board for surface-mount packages.

Table 3. Thermal Resistance

Package Type	θ_{JA}	θ_{JC}	Unit
2 mm × 2 mm LFCSP	84.4	12.32	°C/W

ESD CAUTION



ESD (electrostatic discharge) sensitive device. Charged devices and circuit boards can discharge without detection. Although this product features patented or proprietary protection circuitry, damage may occur on devices subjected to high energy ESD. Therefore, proper ESD precautions should be taken to avoid performance degradation or loss of functionality.

PIN CONFIGURATION AND FUNCTION DESCRIPTIONS

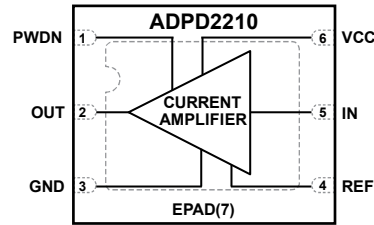

NOTE
1. CONNECT THE EPAD TO GND.

Figure 2. Pin Configuration

12286-001

Table 4. Pin Function Descriptions

Pin No.	Mnemonic	Description
1	PWDN	Power-Down Input. Tie the PWDN pin to ground for normal operation. Connecting this input to a logic high enables standby mode. Do not leave this input floating.
2	OUT	Current Output.
3	GND	Ground.
4	REF	Voltage Reference Output. REF is nominally 1.2 V below V_{CC} . This pin is the matched voltage reference for the current input and is typically tied to the cathode of a photodiode. Attachment to this terminal is not required.
5	IN	Current Input (Sink). The voltage of the IN pin is forced within 5 mV of the reference input.
6	VCC	Supply.
7	EPAD	Exposed Pad. Connect the EPAD to GND.

TYPICAL PERFORMANCE CHARACTERISTICS

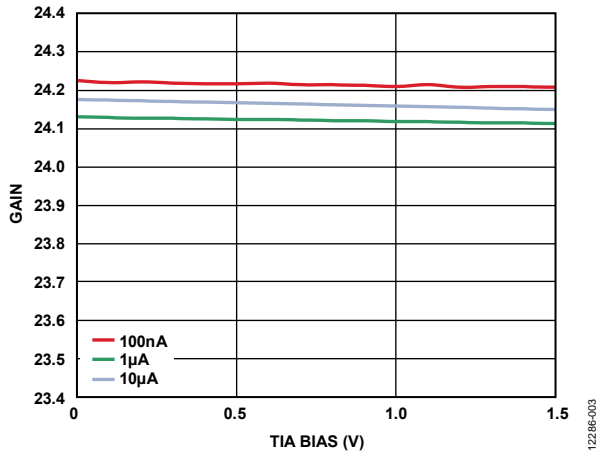

Figure 3. Gain vs. TIA Bias

12286-003

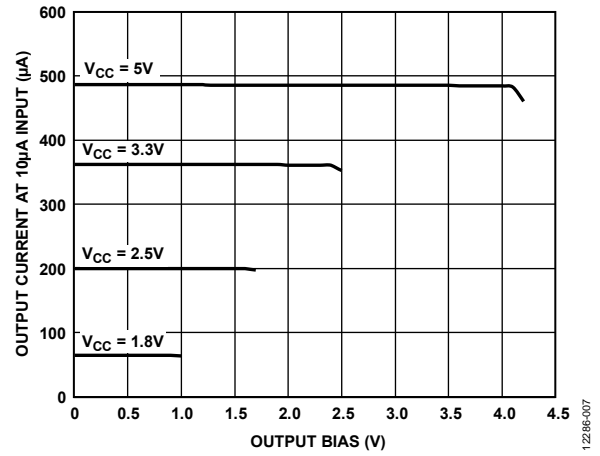

Figure 6. Maximum Output Current vs. Output Bias

12286-007

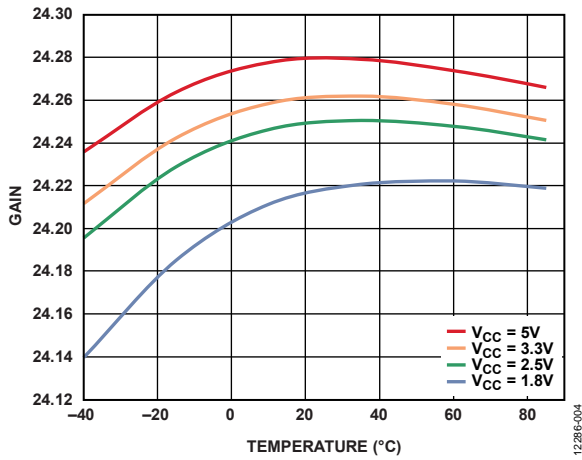

Figure 4. Gain vs. Temperature at 1µA Input Current

12286-004

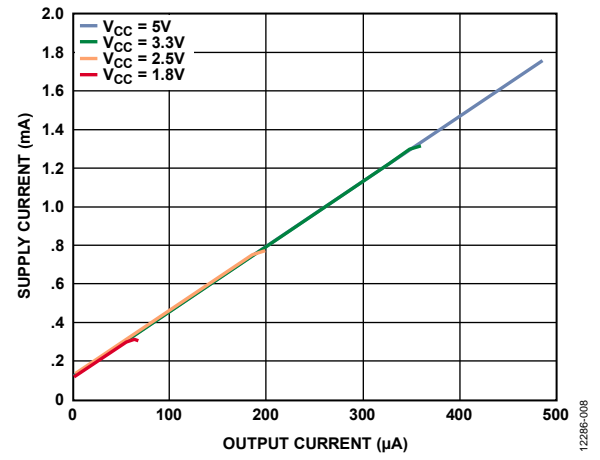

Figure 7. Supply Current vs. Output Current

12286-008

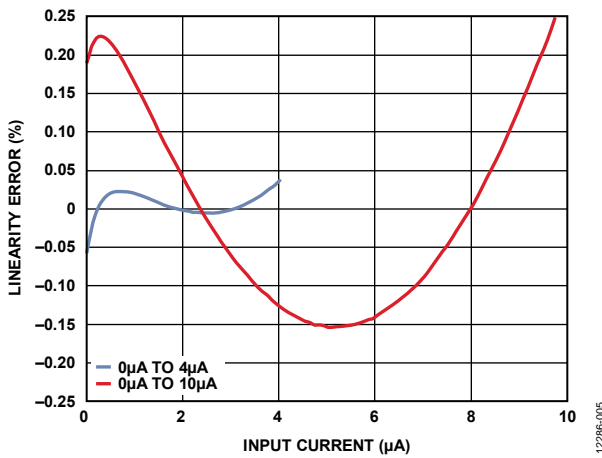

Figure 5. Linearity Error vs. Input Current (Best Fit over Range)

12286-005

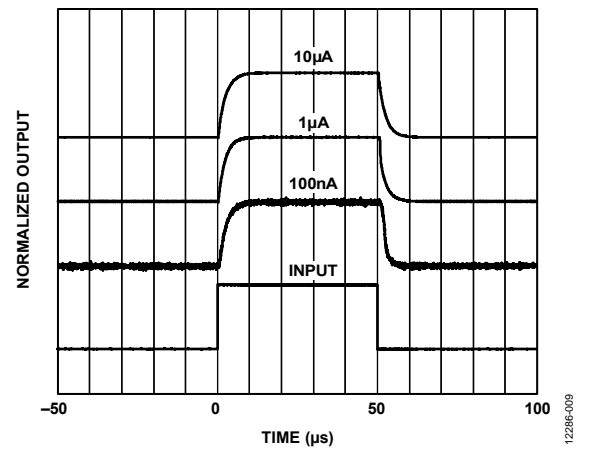

Figure 8. Pulse Response, Rise/Fall

12286-009

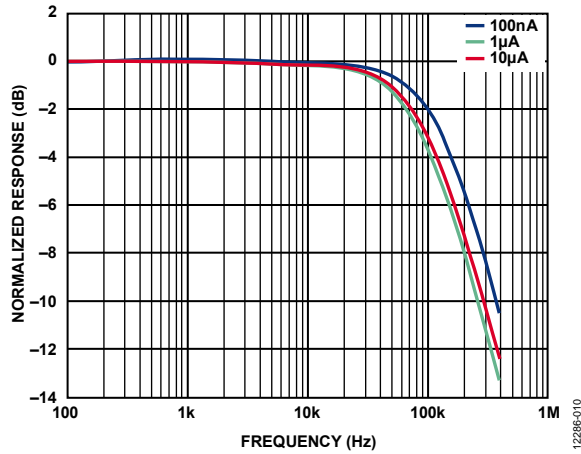

Figure 9. Bandwidth/Peaking

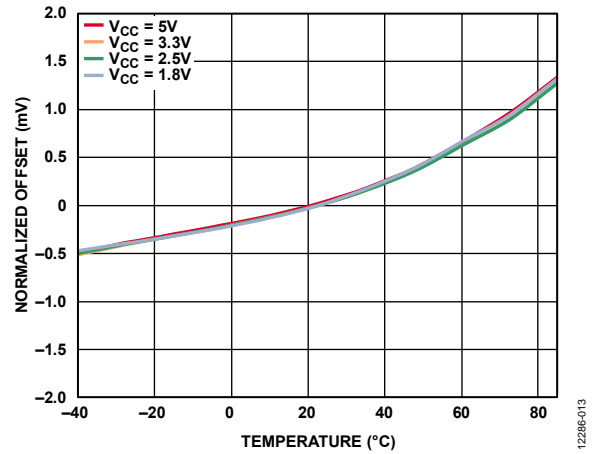

Figure 12. Normalized Offset vs. Temperature

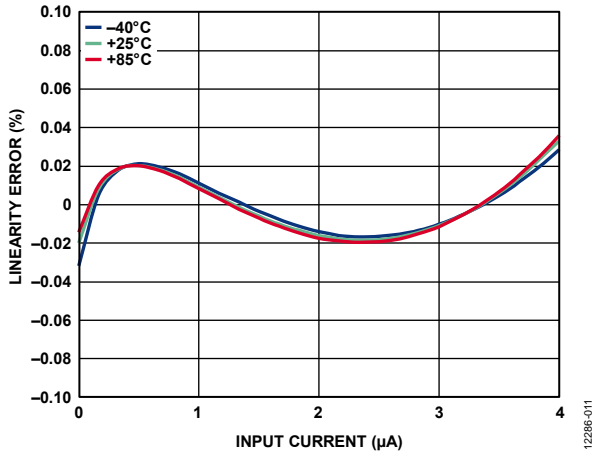

Figure 10. Linearity Error vs. Input Current (TIA) at Various Temperatures

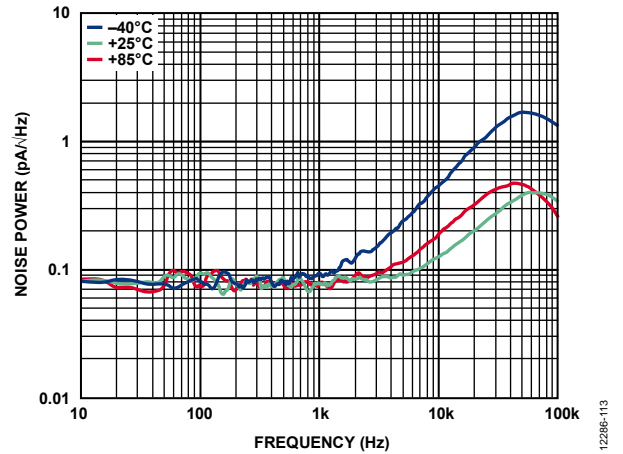

Figure 13. Noise Bandwidth/Peaking

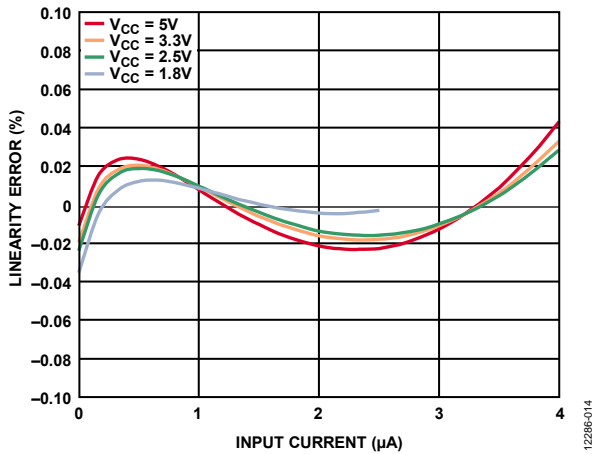

Figure 11. Linearity Error vs. Input Current (TIA) at Various Supplies

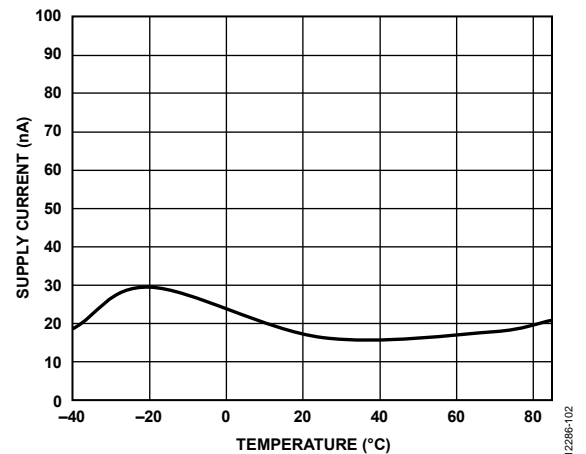

Figure 14. Supply Current in Power-Down vs. Temperature

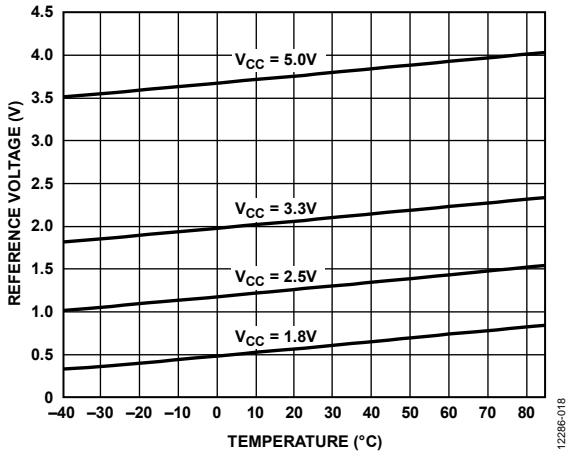

Figure 15. Reference Voltage vs. Temperature

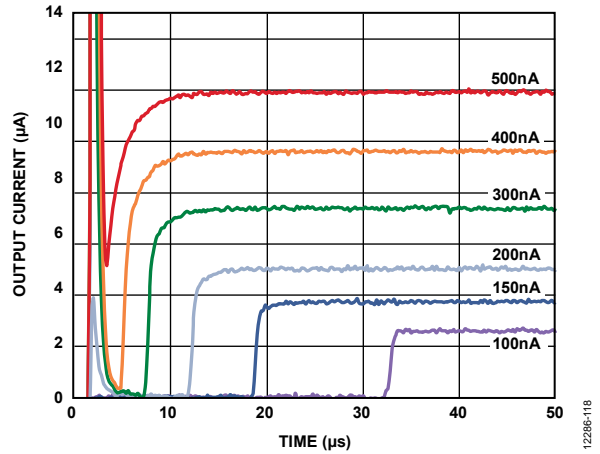

Figure 18. Power-Down Recovery, 100 nA to 500 nA

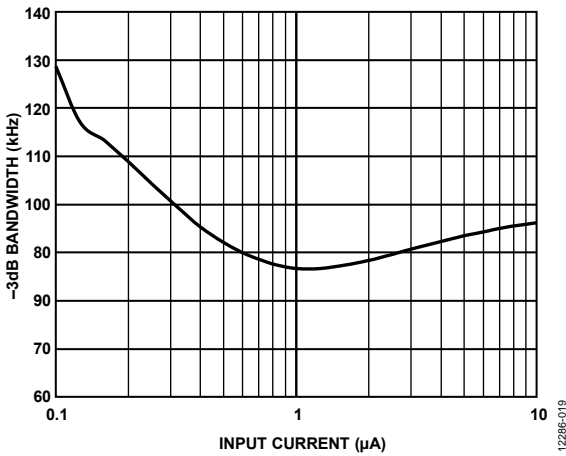

Figure 16. -3 dB Bandwidth vs. Input Current

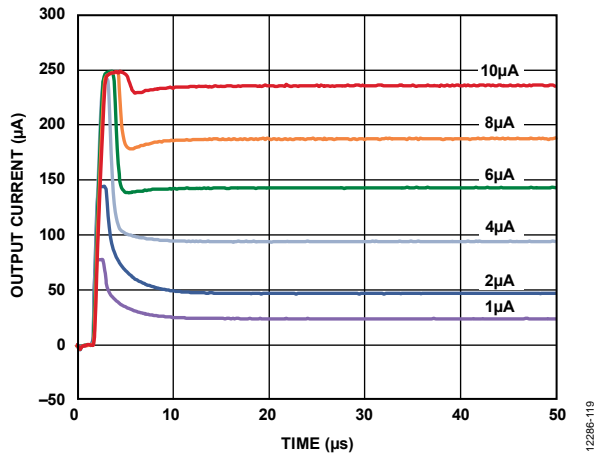

Figure 19. Power-Down Recovery, 1 µA to 10 µA

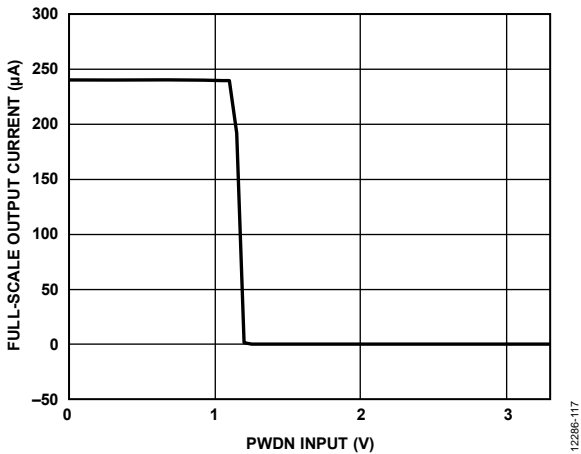

Figure 17. Full-Scale Output Current vs. PWDN Input

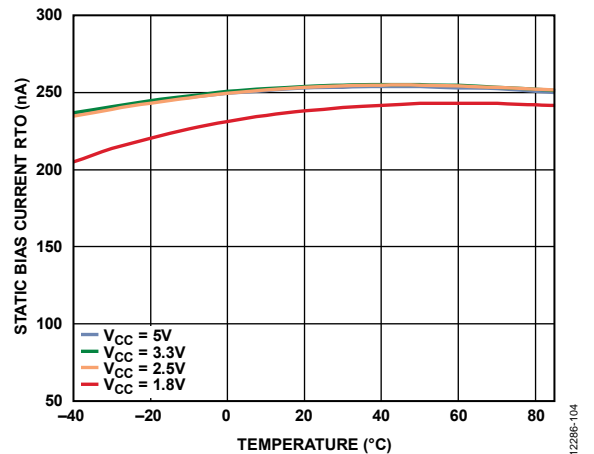

Figure 20. Static Bias Current Referred to Output (RTO) vs. Temperature

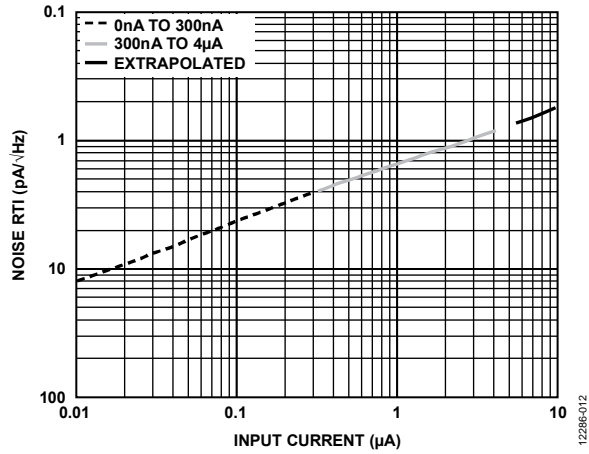

Figure 21. Noise Referred to Input (RTI) vs. Input Current

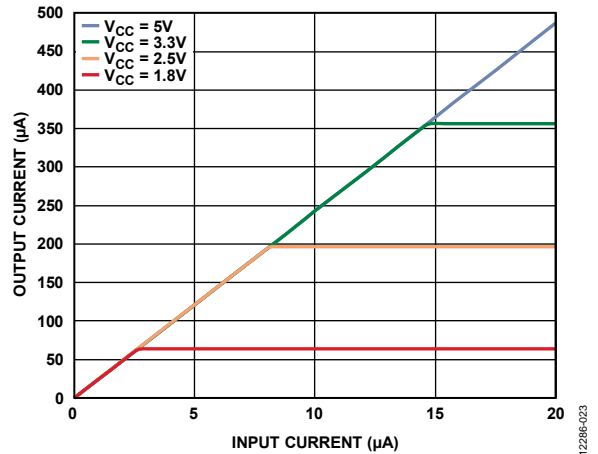

Figure 23. Output Current vs. Input Current

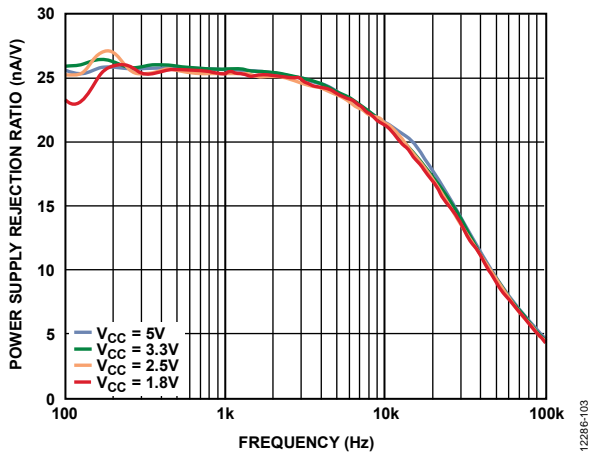

Figure 22. Power Supply Rejection Ratio vs. Frequency

TERMINOLOGY

Amperometry

Amperometry is a technique used in chemistry and biochemistry to detect ions in a solution by measuring very small currents between polarized electrodes. Methods of amperometry include direct, pulsed, and amperometric titration, where a substance (titrate) known to react with the analyte (the substance being measured) is added in measured quantities and the effect on the ionic concentration of the analyte is measured.

Dark Current

Dark current is the current flowing in a photodiode with no light incident upon the diode junction. In reversed bias operation, the dominant source of dark current is current generated by the bias voltage across the bulk resistance of the semiconductor material (shunt resistance). In zero bias operation, thermal generation of charge carriers in the depletion region becomes the dominant source of dark current.

Linearity

Linearity is a measure of the deviation from an ideal change in output current relative to a change in input current. Linearity is specified as the deviation from a best straight line fit of the amplifier current output over a specified range of input current. Linearity is a critical specification in photoplethysmography due to the requirement of sensing small ac signals impressed upon large dc offsets.

Noise Equivalent Power (NEP)

Noise equivalent power is the amount of incident light power on a photo detector, which generates a photocurrent equal to the total noise current of the sensor, expressed as $A/\sqrt{\text{Hz}}$. The NEP is the fundamental baseline of the detectivity of the optical sensor.

Offset

Offset in the ADPD2210 is defined as the differential voltage between the reference output and the input of the ADPD2210. The ADPD2210 holds the input terminal voltage to within ± 5 mV (typical) of the reference terminal.

Photoconductive Mode

Photoconductive operation of a photodiode occurs when photons entering the silicon generate electron/hole pairs that are swept by the electric field to the opposite terminal. These carriers are presented at the terminals of the photodiode as a current proportional to the luminous flux incident on the junction of the photodiode.

Photoplethysmography

Photoplethysmography uses light to measure biological functions by sensing changes in the absorption spectra of soft tissue caused by differences in hemoglobin volume and composition. Common applications of photoplethysmography include transmission SpO₂ pulse oximetry and reflectance HRM.

Shot Noise

Shot noise is a statistical fluctuation in any quantized signal such as photons of light and electrons in current. The magnitude of the shot noise is expressed as a root mean square (rms) noise current. Shot noise is a fundamental limitation in photo detectors and takes the form of

$$\text{Shot noise} = \sqrt{(2qI_{PD}BW)}$$

where:

q is the charge of an electron (1.602×10^{-19} Coulomb).

I_{PD} is the photodiode current.

BW is the bandwidth.

Static Bias

The ADPD2210 has an internal 10 nA bias that is used to linearize the input current mirror at low input levels and prevents transient reverse bias of the amplifier input stage. This bias is fixed and appears on the output as a 240 nA typical offset.

Thermal (Johnson) Noise

All resistors generate a noise component based on temperature, including the shunt resistance in a photodiode due to generation of carriers within the bulk semiconductor. The magnitude of this generated noise current is calculated as follows:

$$\text{Photodiode Thermal Noise Current} = \sqrt{\frac{4kT\Delta f}{RSH}}$$

where:

$k = 1.38 \times 10^{-23}$ joules per °K. k is the Boltzmann constant.

T is the absolute temperature in degrees Kelvin ($273 \text{ K} = 0^\circ\text{C}$).

Δf is the noise measurement bandwidth.

RSH is the shunt resistance of the photodiode

Thermal noise generated in the bulk semiconductor outside the depletion region of the photodiode appears as a broadband ac signal. Thermal noise generated within the depletion region appears as a dc current but is typically an insignificant component of dark current relative to the bias/shunt resistance component.

THEORY OF OPERATION

OVERVIEW

The ADPD2210 is an ultralow noise current amplifier optimized for wearable photoplethysmography applications and featuring very low power consumption. Essentially a current mirror with gain, the ADPD2210 is designed to make sensor signal currents appear 24 times larger while adding minimal noise. A laser trimmed linearity of greater than 60 dB allows the extraction of very small time variant signals with large dc or low frequency components. This noise and linearity performance allows small photodiodes to achieve performance comparable to much larger diodes.

RECOMMENDED CONFIGURATION

In the recommended configuration, a photodiode is connected across the REF and IN pins of the ADPD2210. The REF pin is driven by a servo loop to stay within typically ± 5 mV of the IN pin, regardless of current generated by the optical power incident on the photodiode junction. The current occurring at the anode of the photodiode is sourced to the IN pin and drives the first stage of the precision current mirror. A 10 nA static bias is applied to the current mirror to linearize its transfer curve at low currents and prevent the output from attempting to go below 0 V due to unavoidable offsets.

Figure 24 shows a simplified pulse oximeter design using the ADPD2210.

SENSITIVITY AND SNR

SNR is a measure of the ability of the sensor to separate the signal of interest from spurious signals that occur from the surrounding environment of the device, such as ambient light, electromagnetic interferers, and circuit noise.

Typically, system SNR is improved by using a photodiode with large surface area because signal increases linearly with area while noise increases as a root sum of the square of the area.

Capacitance of the photodiode increases with area and carrier transit time, reducing sensor bandwidth. Bandwidth can be increased by applying a bias voltage across the diode, but this increases dark current and, therefore, noise.

Operating at near zero-bias voltage in photoconductive mode, the photodiode generates virtually no dark current component except for that caused by the offset of the servo loop across the shunt resistance of the diode and the thermal noise component in the depletion region of the photodiode. This sets the fundamental limit of the signal resolution to the shot noise of the 10 nA internal bias, $80 \text{ fA}/\sqrt{\text{Hz}}$ relative to the input, which appears at the output of the current amplifier and establishes the noise floor of the ADPD2210.

PULSE MODE OPERATION

The ADPD2210 is optimized for battery-powered operation by the inclusion of a power down pin (PWDN). When sensing is inactive, the ADPD2210 can be quickly switched into standby mode, reducing supply current to ~ 100 nA during dark periods for pulsed or mode locked applications where the light source is cycled to improve ambient light rejection and reduce transmitter power consumption.

For multiple wavelength systems, sequentially pulsing the optical emitters removes the need for multiple narrow bandwidth sensors. For both multiple wavelength (SpO₂) and single wavelength (HRM) systems, pulsed operation can provide significant power savings for battery-powered systems. Pulsed mode operation provides a calibration signal that is necessary to compensate for ambient light diffused throughout the tissue, which can be extracted by measuring the sensor output while the system emitters are off. Advanced algorithms can then extract the signal of interest from dc offsets, noise, and interferer signals such as motion artifacts.

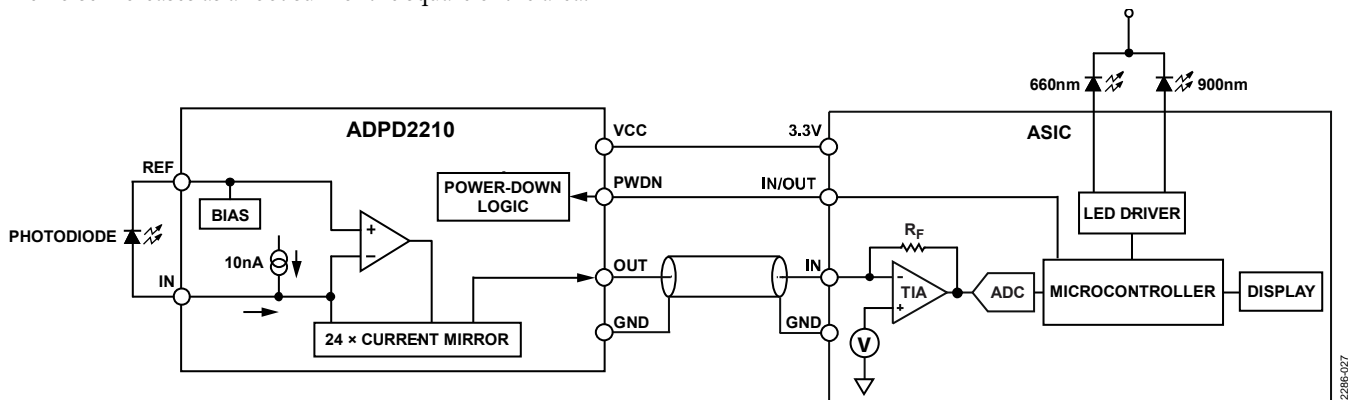

Figure 24. Simplified Pulse Oximeter Design

APPLICATIONS INFORMATION

POWERING THE ADPD2210

The ADPD2210 is powered from a single positive 1.8 V to 5 V supply, although performance below 2.5 V is limited by the reduced dynamic range of the device. Above the quiescent current (140 μ A), the supply current has a linear relationship to the output current: $I_{\text{SUPPLY}} = I_{\text{FLOOR}} + (3.3 \times I_{\text{OUT}})$. The ADPD2210 features a 25 nA/V (typical) PSRR, but proper circuit layout and bypassing is recommended to provide maximum sensitivity, especially in designs where the ADPD2210 may share reference nodes with transmitters in pulse mode applications.

EXPOSED PAD CONNECTION

The exposed pad (EPAD) on the ADPD2210 acts as an electrical, thermal, and mechanical platform for the amplifier and must be connected to a quiet GND. External cooling is not required due to the extremely low power consumption of the ADPD2210. Analog Devices, Inc., recommends removal of active traces beneath the device to eliminate potential coupling of external signals into the sensitive internal nodes of the ADPD2210.

POWER-DOWN

The power-down pin does not have an internal pull-up/pull-down circuit and must be connected to an external logic level for proper operation.

In the recommended configuration and when it is not in power-down mode, the ADPD2210 presents an approximate 90 Ω load to the photodiode anode. This load limits the photovoltaic effect from a silicon photodiode at full scale to approximately 900 μ V. In the power-down state, the ADPD2210 presents a high impedance at the IN pin and the photovoltaic effect from a photodiode is limited to the open-circuit voltage of the photodiode.

In applications where the ADPD2210 is fed from a current source, initiation of power-down mode causes the voltage at the IN pin to slew up to the compliance voltage of the current source. The rate at which the voltage slews depends on the current sourced and capacitance at the IN pin. If the compliance voltage of the current source is significantly higher than the $V_{\text{CC}} - 2 \times V_{\text{BE}}$ voltage of the IN pin, the ADPD2210 requires additional settling time to come out of the power-down state. V_{BE} is the base emitter voltage.

REFERENCE OUTPUT

The REF pin is sensitive to loading and is not intended to drive more than 1 μ A. When the ADPD2210 REF output is connected to the cathode of the photodiode, loading of the REF pin is limited to the offset voltage (± 5 mV), divided by the shunt resistance (typically >1 G Ω) of the photodiode.

In applications where the REF output is used to provide an external reference or a guarding voltage, the REF output must be buffered. Failure to buffer the REF pin may adversely affect linearity above 4 μ A.

LAYOUT CONSIDERATIONS

Working with very low currents requires special attention in layout to prevent error currents due to leakage, especially in instrumentation applications where the ADPD2210 may be located at a distance from the current source. In applications that rely on dynamic signals, parasitic capacitance must be controlled as seemingly insignificant capacitance becomes problematic with nanoampere scale signals.

OUTPUT CONFIGURATION

The output of the ADPD2210 allows different configurations depending on the application. The current gain of the ADPD2210 reduces the effect of surrounding interferers but, for best performance, careful design and layout is still necessary to achieve best performance. The effect of capacitance on the output must be considered carefully regardless of configuration as bandwidth and response time of the system can be limited simply by the time required to charge and discharge parasitics.

Because the ADPD2210 is effectively a current source, the ADPD2210 output voltage drifts up to its compliance voltage, approximately 1.2 V below V_{CC} , when connected to an interface that presents a high impedance. The rate of this drift is dependent on the ADPD2210 output current, parasitic capacitance, and the impedance of the load. This drift can require additional settling time in circuits following the ADPD2210 if they are actively multiplexing the output of the ADPD2210 or presenting a high impedance due to power cycling. For multiplexed systems, a current steering architecture may offer a performance advantage over a break-before-make switch matrix.

ACCURACY IN CLINICAL APPLICATIONS

Even with perfectly calibrated electronics, it is important to note there is no absolute in photoplethysmography measurements because they are affected by other variables, including high levels of carboxyhemoglobin or methemoglobin, density of other chromophores such as melanin, and conditions that may affect perfusion such as peripheral artery disease, shock, or hypothermia. It is important that photoplethysmography, though well suited for real-time monitoring, be supported in a clinical environment with more accurate laboratory procedures such as blood gas analysis.

3-WIRE VOLTAGE CONFIGURATION

The ADPD2210 can be used in a minimal 3-wire voltage configuration, offering a compact solution with very few components (see Figure 25). A shunt resistor (R_S) sets the transimpedance gain in front of the analog-to-digital converter (ADC). This configuration allows flexibility in matching the ADC converter full-scale input to the full-scale output of the ADPD2210. The dynamic range of the interface is limited to the compliance voltage of the ADPD2210.

No additional amplification is needed prior to the ADC. Response time at the lower end of the range is limited by the ability of the output current to charge the parasitic capacitance presented to the output of the ADPD2210.

3-WIRE CURRENT MODE CONFIGURATION

When used in the 3-wire current mode configuration with a photodiode (see Figure 25), the ADPD2210 is insensitive to load resistance and can be used when the signal processing is further from the sensor. EMI noise and shielding requirements are minimized; however, cable capacitance has a direct effect on bandwidth, making the 3-wire current mode configuration a better choice for unshielded interfaces. The C_F value must be chosen carefully to eliminate stability and bandwidth degradation of the ADPD2210. Large capacitance around the feedback loop of the TIA has a direct effect on the bandwidth of the system.

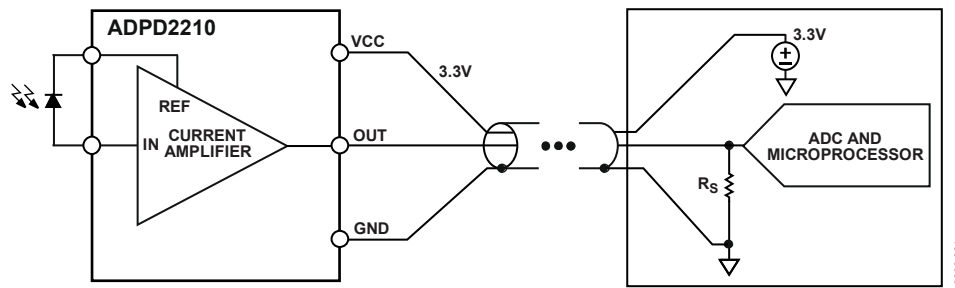

Figure 25. ADPD2210 Used in 3-Wire Short Cable Voltage Mode Configuration with a Shunt Resistor

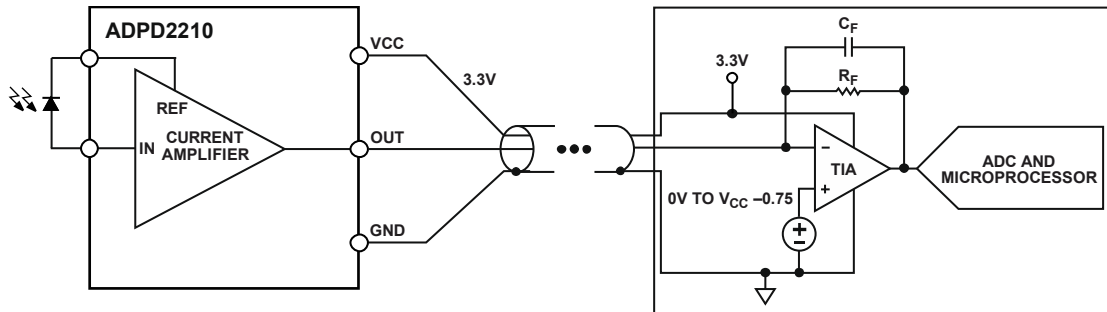
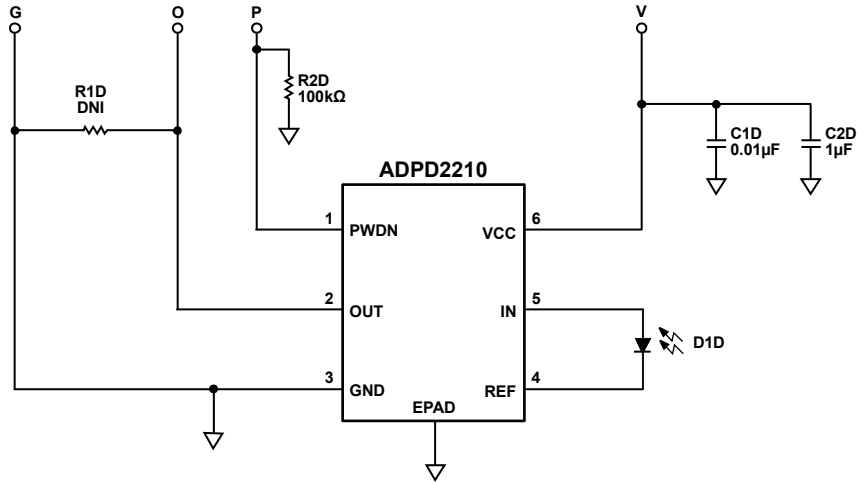

Figure 26. ADPD2210 Used in 3-Wire Current Mode Configuration with a TIA

EVALUATION BOARD

Figure 27 shows the evaluation board schematic. Figure 28 and Figure 29 show the evaluation board layout for the top and bottom layers, respectively.



¹THE PWN PIN MUST BE BIASED TO V_{IL} FOR NORMAL OPERATION AND V_{IH} FOR STANDBY.

²R1D IS NOT NORMALLY INSTALLED BUT CAN BE POPULATED WITH A LOAD RESISTOR TO GENERATE THE VOLTAGE OUTPUT.

12286-024

Figure 27. Evaluation Board Schematic

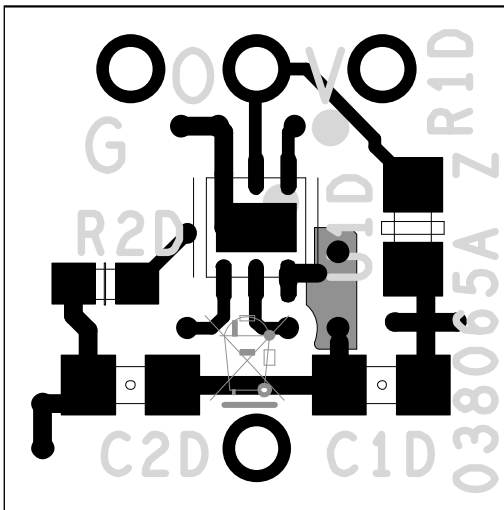

Figure 28. Evaluation Board Layout, Top Layer

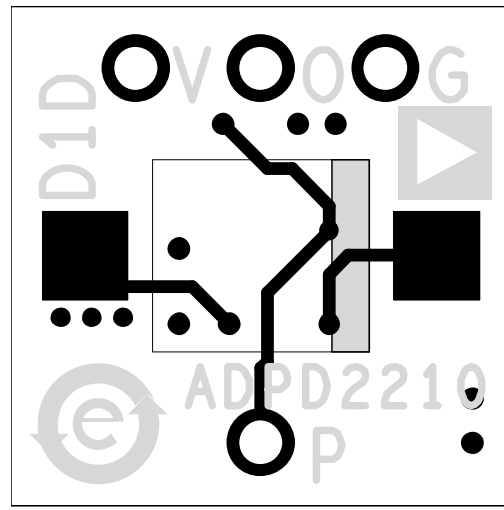

Figure 29. Evaluation Board Layout, Bottom Layer

OUTLINE DIMENSIONS

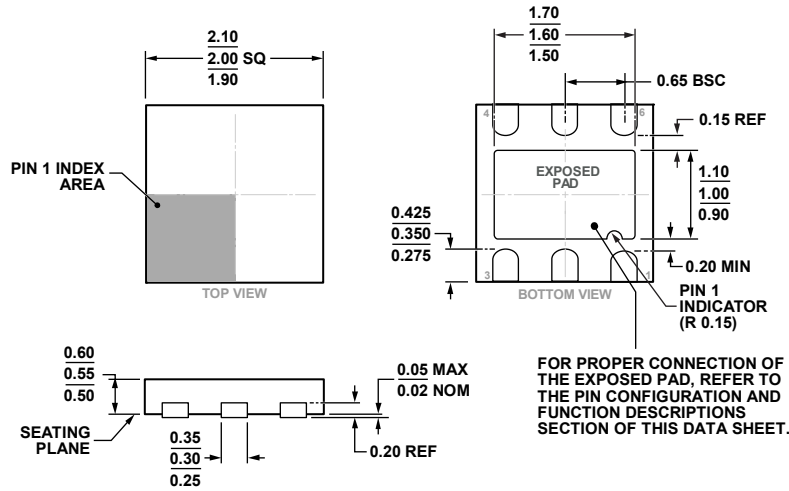

Figure 30. 6-Lead Lead Frame Chip Scale Package [LFCSP_UD]
 2 mm x 2 mm Body, Ultra Thin, Dual Lead
 (CP-6-3)
 Dimensions shown in millimeters

ORDERING GUIDE

Model ¹	Temperature Range	Package Descriptions	Package Option
ADPD2210ACPZ-R7	-40°C to +85°C	6-Lead Lead Frame Chip Scale Package [LFCSP_UD]	CP-6-3
ADPD2210ACPZ-RL	-40°C to +85°C	6-Lead Lead Frame Chip Scale Package [LFCSP_UD]	CP-6-3
EVALZ-ADPD2210		Evaluation Board	

¹ Z = RoHS Compliant Part.