



## 12-Bit, 125MSPS, Ultralow-Power ADC with Analog Buffer

Check for Samples: [ADS41B25](#)

### FEATURES

- **Resolution: 12-Bit, 125MSPS**
- **Integrated High-Impedance Analog Input Buffer:**
  - **Input Capacitance at dc: 3.5pF**
  - **Input Resistance at dc: 10k $\Omega$**
- **Maximum Sample Rate: 125MSPS**
- **Ultralow Power:**
  - **1.8V Analog Power: 114mW**
  - **3.3V Buffer Power: 96mW**
  - **I/O Power: 100mW (DDR LVDS)**
- **High Dynamic Performance:**
  - **SNR: 68.3dBFS at 170MHz**
  - **SFDR: 87dBc at 170MHz**
- **Output Interface:**
  - **Double Data Rate (DDR) LVDS with Programmable Swing and Strength:**
    - **Standard Swing: 350mV**
    - **Low Swing: 200mV**
    - **Default Strength: 100 $\Omega$  Termination**
    - **2x Strength: 50 $\Omega$  Termination**
  - **1.8V Parallel CMOS Interface Also Supported**
- **Programmable Gain for SNR/SFDR Trade-Off**
- **DC Offset Correction**
- **Supports Low Input Clock Amplitude**
- **Package: QFN-48 (7mm  $\times$  7mm)**

### DESCRIPTION

The ADS41B25 is a member of the ultralow-power ADS4xxx analog-to-digital converter (ADC) family, featuring integrated analog input buffers. This device uses innovative design techniques to achieve high dynamic performance, while consuming extremely low power. The analog input pins have buffers, with the benefits of constant performance and input impedance across a wide frequency range. The device is well-suited for multi-carrier, wide bandwidth communications applications such as PA linearization.

The ADS41B25 has features such as digital gain and offset correction. The gain option can be used to improve SFDR performance at lower full-scale input ranges, especially at high input frequencies. The integrated dc offset correction loop can be used to estimate and cancel the ADC offset. At lower sampling rates, the ADC automatically operates at scaled-down power with no loss in performance.

The device supports both double data rate (DDR) low-voltage differential signaling (LVDS) and parallel CMOS digital output interfaces. The low data rate of the DDR LVDS interface (maximum 500MBPS) makes it possible to use low-cost field-programmable gate array (FPGA)-based receivers. The device has a low-swing LVDS mode that can be used to further reduce the power consumption. The strength of the LVDS output buffers can also be increased to support 50 $\Omega$  differential termination.

The device is available in a compact QFN-48 package and is specified over the industrial temperature range ( $-40^{\circ}\text{C}$  to  $+85^{\circ}\text{C}$ ).



Please be aware that an important notice concerning availability, standard warranty, and use in critical applications of Texas Instruments semiconductor products and disclaimers thereto appears at the end of this data sheet.

PowerPAD is a trademark of Texas Instruments, Incorporated.  
All other trademarks are the property of their respective owners.



This integrated circuit can be damaged by ESD. Texas Instruments recommends that all integrated circuits be handled with appropriate precautions. Failure to observe proper handling and installation procedures can cause damage.

ESD damage can range from subtle performance degradation to complete device failure. Precision integrated circuits may be more susceptible to damage because very small parametric changes could cause the device not to meet its published specifications.

**ORDERING INFORMATION<sup>(1)</sup>**

PRODUCT	PACKAGE-LEAD	PACKAGE DESIGNATOR	SPECIFIED TEMPERATURE RANGE	ECO PLAN <sup>(2)</sup>	LEAD/BALL FINISH	PACKAGE MARKING	ORDERING NUMBER	TRANSPORT MEDIA
ADS41B25	QFN-48	RGZ	-40°C to +85°C	GREEN (RoHS, no Sb/Br)	Cu/NiPdAu	AZ41B25	ADS41B25IRGZR	Tape and reel
							ADS41B25IRGZT	Tape and reel

- (1) For the most current package and ordering information, see the Package Option Addendum at the end of this document, or visit the device product folder at [www.ti.com](http://www.ti.com).
- (2) Eco Plan is the planned eco-friendly classification. Green (RoHS, no Sb/Br): TI defines Green to mean Pb-Free (RoHS compatible) and free of Bromine- (Br) and Antimony- (Sb) based flame retardants. Refer to the [Quality and Lead-Free \(Pb-Free\) Data](#) web site for more information.

**ABSOLUTE MAXIMUM RATINGS<sup>(1)</sup>**

		ADS41B25		UNIT
		MIN	MAX	
Supply voltage range, AVDD		-0.3	2.1	V
Supply voltage range, AVDD_BUF		-0.3	3.9	V
Supply voltage range, DRVDD		-0.3	2.1	V
Voltage between AGND and DRGND		-0.3	0.3	V
Voltage between AVDD to DRVDD (when AVDD leads DRVDD)		-2.4	2.4	V
Voltage between DRVDD to AVDD (when DRVDD leads AVDD)		-2.4	2.4	V
Voltage between AVDD_BUF to DRVDD/AVDD		-4.2	4.2	V
Voltage applied to input pins	INP, INM	-0.3	Minimum (1.9, AVDD + 0.3)	V
	CLKP, CLKM <sup>(2)</sup> , RESET, SCLK, SDATA, SEN, DFS	-0.3	AVDD + 0.3	V
Operating free-air temperature range, T <sub>A</sub>		-40	+85	°C
Operating junction temperature range, T <sub>J</sub>			+125	°C
Storage temperature range, T <sub>stg</sub>		-65	+150	°C
ESD, human body model (HBM)			2	kV

- (1) Stresses above these ratings may cause permanent damage. Exposure to absolute maximum conditions for extended periods may degrade device reliability. These are stress ratings only, and functional operation of the device at these or any other conditions beyond those specified is not implied.
- (2) When AVDD is turned off, it is recommended to switch off the input clock (or ensure the voltage on CLKP, CLKM is less than |0.3V|. Doing so prevents the ESD protection diodes at the clock input pins from turning on.

**THERMAL INFORMATION**

THERMAL METRIC <sup>(1)</sup>		ADS41B25		UNITS
		RGZ		
		48 PINS		
θ <sub>JA</sub>	Junction-to-ambient thermal resistance	27.9		°C/W
θ <sub>JCtop</sub>	Junction-to-case (top) thermal resistance	15.1		
θ <sub>JB</sub>	Junction-to-board thermal resistance	5.4		
ψ <sub>JT</sub>	Junction-to-top characterization parameter	0.3		
ψ <sub>JB</sub>	Junction-to-board characterization parameter	5.4		
θ <sub>JCbot</sub>	Junction-to-case (bottom) thermal resistance	1.7		

- (1) For more information about traditional and new thermal metrics, see the *IC Package Thermal Metrics* application report, [SPRA953](#).

**RECOMMENDED OPERATING CONDITIONS**

		ADS41B25			UNIT
		MIN	TYP	MAX	
<b>SUPPLIES</b>					
AVDD	Analog supply voltage	1.7	1.8	1.9	V
AVDD_BUF	Analog buffer supply voltage	3	3.3	3.6	V
DRVDD	Digital supply voltage	1.7	1.8	1.9	V
<b>ANALOG INPUTS</b>					
Differential input voltage range <sup>(1)</sup>		1.5			V <sub>PP</sub>
Input common-mode voltage		1.7 ± 0.05			V
Maximum analog input frequency with 1.5V <sub>PP</sub> input amplitude <sup>(2)</sup>		400			MHZ
Maximum analog input frequency with 1V <sub>PP</sub> input amplitude <sup>(2)</sup>		600			MHZ
<b>CLOCK INPUT</b>					
Low-speed mode enabled <sup>(3)</sup>		20		80	MSPS
Low-speed mode disabled <sup>(3)</sup>		80		125	MSPS
Input clock amplitude differential (V <sub>CLKP</sub> – V <sub>CLKM</sub> )					
Sine wave, ac-coupled		0.2	1.5		V <sub>PP</sub>
LVPECL, ac-coupled			1.6		V <sub>PP</sub>
LVDS, ac-coupled			0.7		V <sub>PP</sub>
LVCMOS, single-ended, ac-coupled			1.8		V
Input clock duty cycle	Low-speed mode enabled	40	50	60	%
	Low-speed mode disabled	35	50	65	%
<b>DIGITAL OUTPUTS</b>					
C <sub>LOAD</sub>	Maximum external load capacitance from each output pin to DRGND	5			pF
R <sub>LOAD</sub>	Differential load resistance between the LVDS output pairs (LVDS mode)	100			Ω
T <sub>A</sub>	Operating free-air temperature	–40		+85	°C

- (1) With 0dB gain. See the [Gain for SFDR/SNR Trade-Off](#) section in [Application Information](#) for the relationship between input voltage range and gain.
- (2) See the [Theory of Operation](#) section in the [Application Information](#).
- (3) See the [Serial Interface](#) section for details on the low-speed mode.

**HIGH-PERFORMANCE MODES<sup>(1)(2)(3)</sup>**

PARAMETER	DESCRIPTION
MODE 1	Set the MODE 1 register bits to get the best performance across sample clock and input signal frequencies. Register address = 03h, register data = 03h.
MODE 2	Set the MODE 2 register bit to get the best performance at high input signal frequencies greater than 230MHz. Register address = 4Ah, register data = 01h.

- (1) It is recommended to use these modes to get best performance. These modes can only be set with the serial interface.
- (2) See the [Serial Interface](#) section for details on register programming.
- (3) Note that these modes cannot be set when the serial interface is not used (when the RESET pin is tied high); see the [Device Configuration](#) section.

**ELECTRICAL CHARACTERISTICS: ADS41B25**

Typical values are at +25°C, AVDD = 1.8V, AVDD\_BUF = 3.3V, DRVDD = 1.8V, 1.5V<sub>PP</sub> clock amplitude, 50% clock duty cycle, –1dBFS differential analog input, and DDR LVDS interface, unless otherwise noted. Minimum and maximum values are across the full temperature range: T<sub>MIN</sub> = –40°C to T<sub>MAX</sub> = +85°C, AVDD = 1.8V, AVDD\_BUF = 3.3V, and DRVDD = 1.8V.

PARAMETER	TEST CONDITIONS	ADS41B25			UNIT
		MIN	TYP	MAX	
Resolution				12	Bits
SNR (signal-to-noise ratio), LVDS	f <sub>IN</sub> = 20MHz		68.8		dBFS
	f <sub>IN</sub> = 70MHz	66.5	68.7		dBFS
	f <sub>IN</sub> = 100MHz		68.6		dBFS
	f <sub>IN</sub> = 170MHz		68.3		dBFS
	f <sub>IN</sub> = 300MHz		67		dBFS
SINAD (signal-to-noise and distortion ratio), LVDS	f <sub>IN</sub> = 20MHz		68.8		dBFS
	f <sub>IN</sub> = 70MHz	65.5	68.6		dBFS
	f <sub>IN</sub> = 100MHz		68.5		dBFS
	f <sub>IN</sub> = 170MHz		68.2		dBFS
	f <sub>IN</sub> = 300MHz		65.4		dBFS
Spurious-free dynamic range SFDR	f <sub>IN</sub> = 20MHz		89		dBc
	f <sub>IN</sub> = 70MHz	78	88		dBc
	f <sub>IN</sub> = 100MHz		89		dBc
	f <sub>IN</sub> = 170MHz		87		dBc
	f <sub>IN</sub> = 300MHz		71		dBc
Total harmonic distortion THD	f <sub>IN</sub> = 20MHz		86		dBc
	f <sub>IN</sub> = 70MHz	77	86		dBc
	f <sub>IN</sub> = 100MHz		85		dBc
	f <sub>IN</sub> = 170MHz		83		dBc
	f <sub>IN</sub> = 300MHz		69		dBc
Second-harmonic distortion HD2	f <sub>IN</sub> = 20MHz		89		dBc
	f <sub>IN</sub> = 70MHz	78	88		dBc
	f <sub>IN</sub> = 100MHz		89		dBc
	f <sub>IN</sub> = 170MHz		90		dBc
	f <sub>IN</sub> = 300MHz		78		dBc
Third-harmonic distortion HD3	f <sub>IN</sub> = 20MHz		100		dBc
	f <sub>IN</sub> = 70MHz	78	93		dBc
	f <sub>IN</sub> = 100MHz		91		dBc
	f <sub>IN</sub> = 170MHz		87		dBc
	f <sub>IN</sub> = 300MHz		71		dBc
Worst spur (other than second and third harmonics)	f <sub>IN</sub> = 20MHz		93		dBc
	f <sub>IN</sub> = 70MHz	82.5	94		dBc
	f <sub>IN</sub> = 100MHz		94		dBc
	f <sub>IN</sub> = 170MHz		95		dBc
	f <sub>IN</sub> = 300MHz		91		dBc
Two-tone intermodulation distortion IMD	f <sub>1</sub> = 185MHz, f <sub>2</sub> = 190MHz, each tone at –7dBFS		–86		dBFS
Input overload recovery	Recovery to within 1% (of final value) for 6dB overload with sine-wave input		1		Clock cycle
AC power-supply rejection ratio PSRR	For 100mV <sub>PP</sub> signal on AVDD supply, up to 10MHz		30		dB
Effective number of bits ENOB	f <sub>IN</sub> = 70MHz		11.1		LSBs
Integrated nonlinearity INL	f <sub>IN</sub> = 70MHz		±1.5	±3.5	LSBs

## ELECTRICAL CHARACTERISTICS: GENERAL

Typical values are at +25°C, AVDD = 1.8V, AVDD\_BUF = 3.3V, DRVDD = 1.8V, and 50% clock duty cycle, unless otherwise noted. Minimum and maximum values are across the full temperature range: T<sub>MIN</sub> = –40°C to T<sub>MAX</sub> = +85°C, AVDD = 1.8V, AVDD\_BUF = 3.3V, and DRVDD = 1.8V.

PARAMETER	ADS41B25			UNIT
	MIN	TYP	MAX	
<b>ANALOG INPUTS</b>				
Differential input voltage range		1.5		V <sub>PP</sub>
Differential input resistance, at dc (see <a href="#">Figure 42</a> )		10		kΩ
Differential input capacitance, at dc (see <a href="#">Figure 43</a> )		3.5		pF
Analog input bandwidth		800		MHz
Analog input common-mode current (per input pin)		0.04		μA
Common-mode output voltage	VCM	1.7		V
VCM output current capability		4		mA
<b>DC ACCURACY</b>				
Offset error	–15	2.5	15	mV
Temperature coefficient of offset error		0.003		mV/°C
Gain error as a result of internal reference inaccuracy alone	E <sub>GREF</sub>	–2	2	%FS
Gain error of channel alone	E <sub>GCHAN</sub>	2.5		%FS
<b>POWER SUPPLY</b>				
IAVDD Analog supply current		64	73	mA
IAVDD_BUF Analog input buffer supply current		29	42	mA
IDRVDD <sup>(1)</sup> Output buffer supply current LVDS interface with 100Ω external termination Low LVDS swing (200mV)		42		mA
IDRVDD Output buffer supply current LVDS interface with 100Ω external termination Standard LVDS swing (350mV)		55	65	mA
IDRVDD output buffer supply current <sup>(1)(2)</sup> CMOS interface <sup>(2)</sup> f <sub>IN</sub> = 2.5MHz		32		mA
Global power-down		10	25	mW
Standby		145		mW

- (1) The maximum DRVDD current with CMOS interface depends on the actual load capacitance on the digital output lines. Note that the maximum recommended load capacitance on each digital output line is 10pF.
- (2) In CMOS mode, the DRVDD current scales with the sampling frequency, the load capacitance on output pins, input frequency, and the supply voltage (see the [CMOS Interface Power Dissipation](#) section in the [Application Information](#)).

### DIGITAL CHARACTERISTICS

Typical values are at +25°C, AVDD = 1.8V, AVDD\_BUF = 3.3V, and DRVDD = 1.8V, unless otherwise noted. Minimum and maximum values are across the full temperature range: T<sub>MIN</sub> = -40°C to T<sub>MAX</sub> = +85°C, AVDD = 1.8V, AVDD\_BUF = 3.3V, and DRVDD = 1.8V.

PARAMETER	TEST CONDITIONS	ADS41B25			UNIT	
		MIN	TYP	MAX		
<b>DIGITAL INPUTS (RESET, SCLK, SDATA, SEN, OE)</b>						
High-level input voltage	RESET, SCLK, SDATA, and SEN support 1.8V and 3.3V CMOS logic levels	1.3			V	
Low-level input voltage				0.4	V	
High-level input voltage	OE only supports 1.8V CMOS logic levels	1.3			V	
Low-level input voltage				0.4	V	
High-level input current: SDATA, SCLK <sup>(1)</sup>	V <sub>HIGH</sub> = 1.8V		10		μA	
High-level input current: SEN <sup>(2)</sup>	V <sub>HIGH</sub> = 1.8V		0		μA	
Low-level input current: SDATA, SCLK	V <sub>LOW</sub> = 0V		0		μA	
Low-level input current: SEN	V <sub>LOW</sub> = 0V		-10		μA	
<b>DIGITAL OUTPUTS (CMOS INTERFACE: D0 TO D13, OVR_SDOUT)</b>						
High-level output voltage		DRVDD - 0.1	DRVDD		V	
Low-level output voltage			0	0.1	V	
<b>DIGITAL OUTPUTS (LVDS INTERFACE: D0_D1_P/M to D12_D13_P/M, CLKOUTP/M)</b>						
High-level output voltage <sup>(3)</sup>	V <sub>ODH</sub>	Standard swing LVDS	270	+350	430	mV
Low-level output voltage <sup>(3)</sup>	V <sub>ODL</sub>	Standard swing LVDS	-430	-350	-270	mV
High-level output voltage <sup>(3)</sup>	V <sub>ODH</sub>	Low swing LVDS		+200		mV
Low-level output voltage <sup>(3)</sup>	V <sub>ODL</sub>	Low swing LVDS		-200		mV
Output common-mode voltage	V <sub>OCM</sub>		0.85	1.05	1.25	V

- (1) SDATA and SCLK have an internal 180kΩ pull-down resistor.
- (2) SEN has an internal 180kΩ pull-up resistor to AVDD.
- (3) With an external 100Ω termination.

**PIN CONFIGURATION (CMOS MODE)**

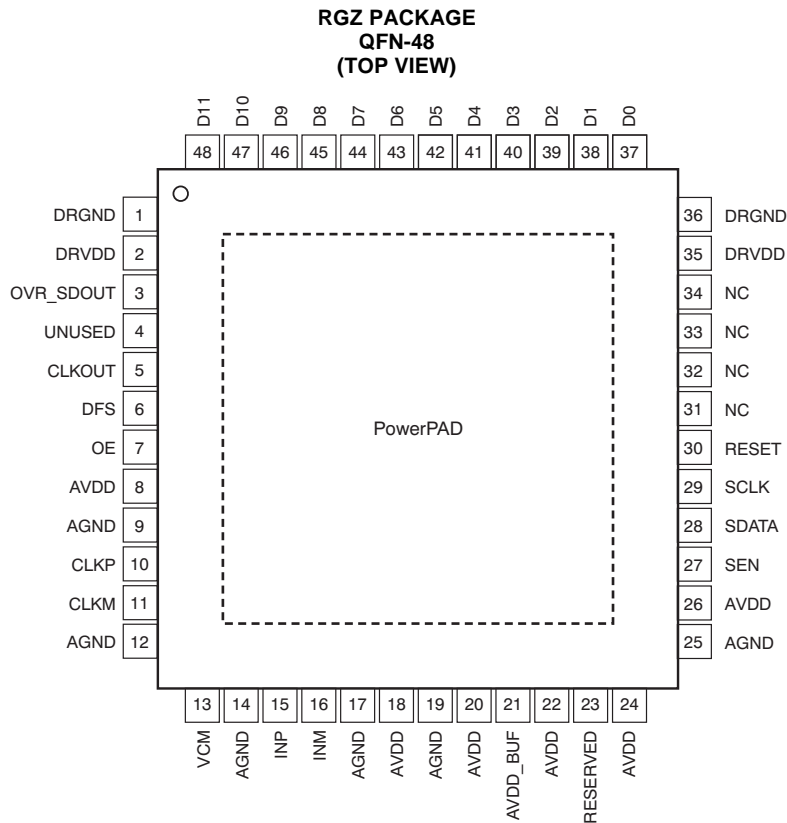

NOTE: The PowerPAD™ is connected to DRGND.

**Figure 1. CMOS Pinout**

**Pin Descriptions (CMOS Mode)**

PIN NAME	PIN NUMBER	# OF PINS	FUNCTION	DESCRIPTION
AVDD	8, 18, 20, 22, 24, 26	6	I	1.8V analog power supply
AVDD_BUF	21	1	I	3.3V input buffer supply
AGND	9, 12, 14, 17, 19, 25	6	I	Analog ground
CLKP	10	1	I	Differential clock input, positive
CLKM	11	1	I	Differential clock input, negative
INP	15	1	I	Differential analog input, positive
INM	16	1	I	Differential analog input, negative
VCM	13	1	O	Outputs the common-mode voltage that can be used externally to bias the analog input pins.
RESET	30	1	I	Serial interface RESET input. When using the serial interface mode, the internal registers must initialize through hardware RESET by applying a high pulse on this pin or by using the software reset option; refer to the <i>Serial Interface</i> section. When RESET is tied high, the internal registers are reset to the default values. In this condition, SEN can be used as a control pin. RESET has an internal 180kΩ pull-down resistor.
SCLK	29	1	I	This pin functions as a serial interface clock input when RESET is low. When RESET is high, SCLK has no function and should be tied to ground. This pin has an internal 180kΩ pull-down resistor
SDATA	28	1	I	This pin functions as a serial interface data input when RESET is low. When RESET is high, SDATA functions as a STANDBY control pin (see <a href="#">Table 5</a> ). This pin has an internal 180kΩ pull-down resistor.

### Pin Descriptions (CMOS Mode) (continued)

PIN NAME	PIN NUMBER	# OF PINS	FUNCTION	DESCRIPTION
SEN	27	1	I	This pin functions as a serial interface enable input when RESET is low. When RESET is high, SEN has no function and should be tied to AVDD. This pin has an internal 180kΩ pull-up resistor to AVDD.
DFS	6	1	I	Data format select input. This pin sets the DATA FORMAT (twos complement or offset binary) and the LVDS/CMOS output interface type. See <a href="#">Table 3</a> for detailed information.
CLKOUT	5	1	O	CMOS output clock
OE	7	1	I	Output buffer enable input, active high; this pin has an internal 180kΩ pull-up resistor to AVDD.
RESERVED	23	1	I	Digital control pin, reserved for future use
D0 to D11	Refer to <a href="#">Figure 1</a>	12	O	12-bit CMOS output data
OVR_SDOUT	3	1	O	This pin functions as an out-of-range indicator after reset, when register bit SERIAL READOUT = 0, and functions as a serial register readout pin when SERIAL READOUT = 1. This pin is a CMOS output level pin (powered from DRVDD).
DRVDD	2, 35	2	I	1.8V digital and output buffer supply
DRGND	1, 36, PAD	2	I	Digital and output buffer ground
UNUSED	4	1	—	Not used
NC	Refer to <a href="#">Figure 1</a>	4	—	Do not connect



PIN CONFIGURATION (LVDS MODE)

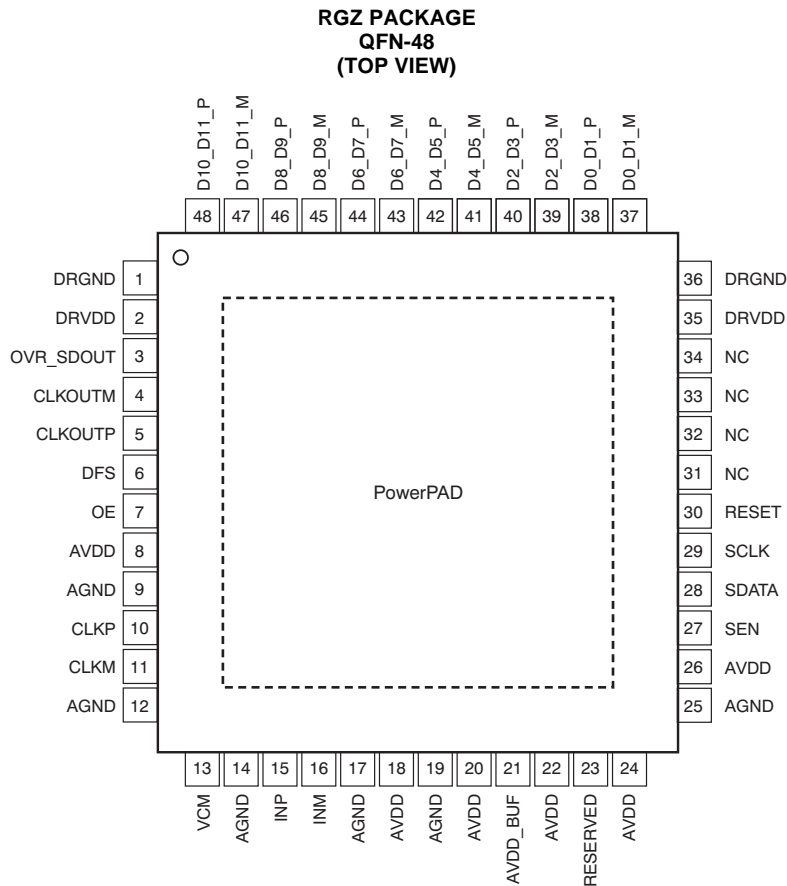

NOTE: The PowerPAD is connected to DRGND.

Figure 2. LVDS Pinout

Pin Descriptions (LVDS Mode)

PIN NAME	PIN NUMBER	# OF PINS	FUNCTION	DESCRIPTION
AVDD	8, 18, 20, 22, 24, 26	6	I	1.8V analog power supply
AVDD_BUF	21	1	I	3.3V input buffer supply
AGND	9, 12, 14, 17, 19, 25	6	I	Analog ground
CLKP	10	1	I	Differential clock input, positive
CLKM	11	1	I	Differential clock input, negative
INP	15	1	I	Differential analog input, positive
INM	16	1	I	Differential analog input, negative
VCM	13	1	O	Outputs the common-mode voltage that can be used externally to bias the analog input pins.
RESET	30	1	I	Serial interface RESET input. When using the serial interface mode, the internal registers must initialize through hardware RESET by applying a high pulse on this pin or by using the software reset option; refer to the <i>Serial Interface</i> section. When RESET is tied high, the internal registers are reset to the default values. In this condition, SDATA can be used as a control pin. RESET has an internal 180kΩ pull-down resistor.
SCLK	29	1	I	This pin functions as a serial interface clock input when RESET is low. When RESET is high, SCLK has no function and should be tied to ground. This pin has an internal 180kΩ pull-down resistor
SDATA	28	1	I	This pin functions as a serial interface data input when RESET is low. When RESET is high, SDATA functions as a STANDBY control pin (see Table 6). This pin has an internal 180kΩ pull-down resistor.

### Pin Descriptions (LVDS Mode) (continued)

PIN NAME	PIN NUMBER	# OF PINS	FUNCTION	DESCRIPTION
SEN	27	1	I	This pin functions as a serial interface enable input when RESET is low. When RESET is high, SEN has no function and should be tied to AVDD. This pin has an internal 180kΩ pull-up resistor to AVDD.
OE	7	1	I	Output buffer enable input, active high; this pin has an internal 180kΩ pull-up resistor to AVDD.
DFS	6	1	I	Data format select input. This pin sets the DATA FORMAT (twos complement or offset binary) and the LVDS/CMOS output interface type (see <a href="#">Table 3</a> ).
RESERVED	23	1	I	Digital control pin, reserved for future use
CLKOUTP	5	1	O	Differential output clock, true
CLKOUTM	4	1	O	Differential output clock, complement
D0_D1_P	Refer to <a href="#">Figure 2</a>	1	O	Differential output data D0 and D1 multiplexed, true
D0_D1_M	Refer to <a href="#">Figure 2</a>	1	O	Differential output data D0 and D1 multiplexed, complement
D2_D3_P	Refer to <a href="#">Figure 2</a>	1	O	Differential output data D2 and D3 multiplexed, true
D2_D3_M	Refer to <a href="#">Figure 2</a>	1	O	Differential output data D2 and D3 multiplexed, complement
D4_D5_P	Refer to <a href="#">Figure 2</a>	1	O	Differential output data D4 and D5 multiplexed, true
D4_D5_M	Refer to <a href="#">Figure 2</a>	1	O	Differential output data D4 and D5 multiplexed, complement
D6_D7_P	Refer to <a href="#">Figure 2</a>	1	O	Differential output data D6 and D7 multiplexed, true
D6_D7_M	Refer to <a href="#">Figure 2</a>	1	O	Differential output data D6 and D7 multiplexed, complement
D8_D9_P	Refer to <a href="#">Figure 2</a>	1	O	Differential output data D8 and D9 multiplexed, true
D8_D9_M	Refer to <a href="#">Figure 2</a>	1	O	Differential output data D8 and D9 multiplexed, complement
D10_D11_P	Refer to <a href="#">Figure 2</a>	1	O	Differential output data D10 and D11 multiplexed, true
D10_D11_M	Refer to <a href="#">Figure 2</a>	1	O	Differential output data D10 and D11 multiplexed, complement
OVR_SDOOUT	3	1	O	This pin functions as an out-of-range indicator after reset, when register bit READOUT = 0, and functions as a serial register readout pin when READOUT = 1. This pin is a 1.8V CMOS output pin (powered from DRVDD).
DRVDD	2, 35	2	I	1.8V digital and output buffer supply
DRGND	1, 36, PAD	2	I	Digital and output buffer ground
NC	Refer to <a href="#">Figure 2</a>	4	—	Do not connect

FUNCTIONAL BLOCK DIAGRAM

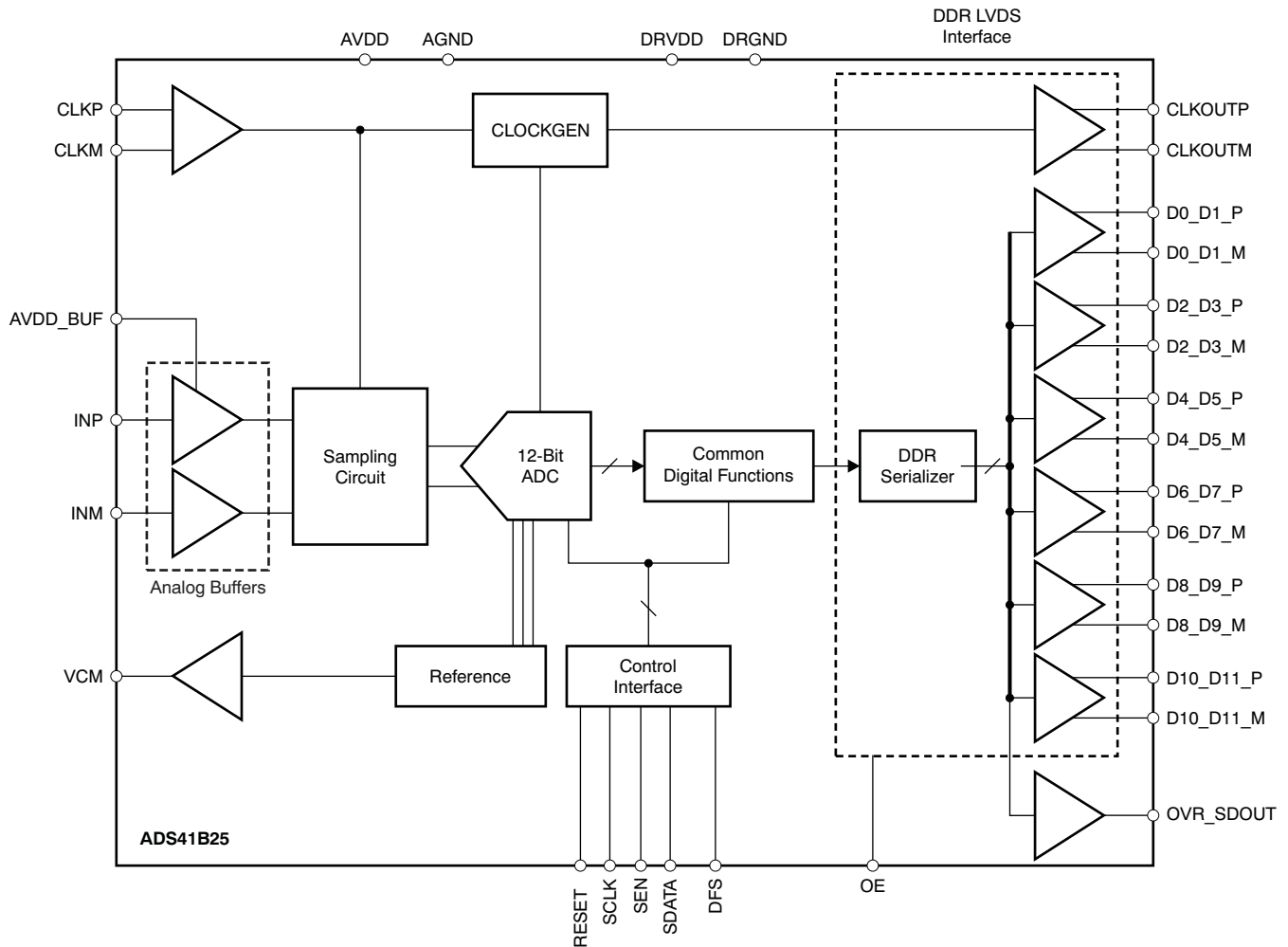
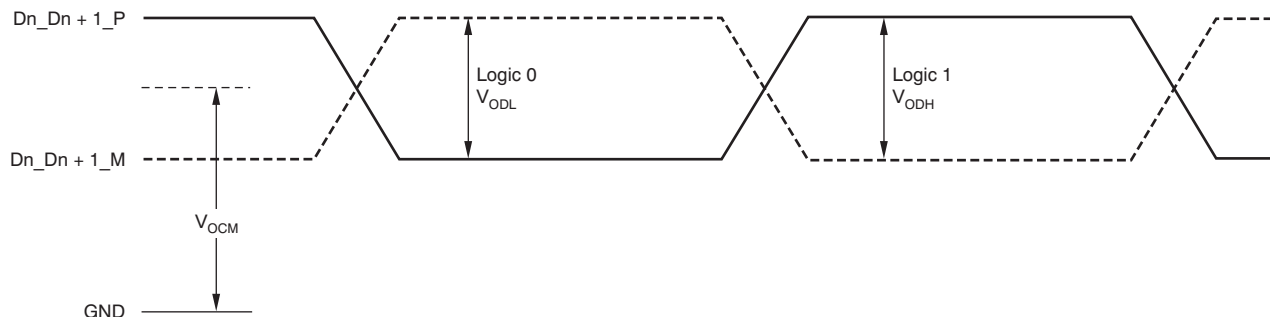

Figure 3. Block Diagram

TIMING CHARACTERISTICS



(1) With external 100Ω termination.

Figure 4. LVDS Output Voltage Levels

**TIMING REQUIREMENTS: LVDS and CMOS Modes<sup>(1)</sup>**

Typical values are at +25°C, AVDD = 1.8V, AVDD\_BUF = 3.3V, DRVDD = 1.8V, sampling frequency = 125MSPS, sine wave input clock, C<sub>LOAD</sub> = 5pF<sup>(2)</sup>, and R<sub>LOAD</sub> = 100Ω<sup>(3)</sup>, unless otherwise noted. Minimum and maximum values are across the full temperature range: T<sub>MIN</sub> = -40°C to T<sub>MAX</sub> = +85°C, AVDD = 1.8V, AVDD\_BUF = 3.3V, and DRVDD = 1.7V to 1.9V.

PARAMETER	CONDITIONS	MIN	TYP	MAX	UNIT		
t <sub>A</sub>	Aperture delay	0.6	0.8	1.2	ns		
	Variation of aperture delay	Between two devices at the same temperature and DRVDD supply		±100	ps		
t <sub>J</sub>	Aperture jitter		100		f <sub>S</sub> rms		
Wakeup time	Time to valid data after coming out of STANDBY mode		5	25	µs		
	Time to valid data after coming out of PDN GLOBAL mode		100	500	µs		
ADC latency <sup>(4)</sup>	Gain enabled (default after reset)		21		Clock cycles		
	Gain and offset correction enabled		22		Clock cycles		
<b>DDR LVDS MODE</b>							
t <sub>SU</sub>	Data setup time <sup>(3)</sup>	Data valid <sup>(5)</sup> to zero-crossing of CLKOUTP		2.3	3.0	ns	
t <sub>H</sub>	Data hold time <sup>(3)</sup>	Zero-crossing of CLKOUTP to data becoming invalid <sup>(5)</sup>		0.35	0.6	ns	
t <sub>PDI</sub>	Clock propagation delay	Input clock rising edge cross-over to output clock rising edge cross-over 1MSPS ≤ sampling frequency ≤ 125MSPS		3	4.2	5.4	ns
	Variation of t <sub>PDI</sub>	Between two devices at the same temperature and DRVDD supply		±0.6		ns	
	LVDS bit clock duty cycle	Duty cycle of differential clock, (CLKOUTP – CLKOUTM) 1MSPS ≤ sampling frequency ≤ 125MSPS		42	48	54	%
t <sub>RISE</sub> , t <sub>FALL</sub>	Data rise time, Data fall time	Rise time measured from -100mV to +100mV Fall time measured from +100mV to -100mV 1MSPS ≤ sampling frequency ≤ 125MSPS		0.14		ns	
t <sub>CLKRISE</sub> , t <sub>CLKFALL</sub>	Output clock rise time, Output clock fall time	Rise time measured from -100mV to +100mV Fall time measured from +100mV to -100mV 1MSPS ≤ sampling frequency ≤ 125MSPS		0.14		ns	
t <sub>OE</sub>	Output enable (OE) to data delay	Time to valid data after OE becomes active		50	100	ns	
<b>PARALLEL CMOS MODE<sup>(6)</sup></b>							
t <sub>SETUP</sub>	Data setup time	Data valid <sup>(5)</sup> to 50% of CLKOUT rising edge		2.5	3.2	ns	
t <sub>HOLD</sub>	Data hold time	Time interval of valid data <sup>(5)</sup>		3.5	4.3	ns	
t <sub>PDI</sub>	Clock propagation delay	Input clock rising edge cross-over to output clock rising edge cross-over 1MSPS ≤ sampling frequency ≤ 125MSPS		4	5.5	7	ns
	Output clock duty cycle	Duty cycle of output clock, CLKOUT 1MSPS ≤ sampling frequency ≤ 125MSPS		47		%	
t <sub>RISE</sub> , t <sub>FALL</sub>	Data rise time, Data fall time	Rise time measured from 20% to 80% of DRVDD Fall time measured from 80% to 20% of DRVDD 1MSPS ≤ sampling frequency ≤ 125MSPS		0.35		ns	
t <sub>CLKRISE</sub> , t <sub>CLKFALL</sub>	Output clock rise time, Output clock fall time	Rise time measured from 20% to 80% of DRVDD Fall time measured from 80% to 20% of DRVDD 1MSPS ≤ sampling frequency ≤ 125MSPS		0.35		ns	
t <sub>OE</sub>	Output enable (OE) to data delay	Time to valid data after OE becomes active		20	40	ns	

- (1) Timing parameters are ensured by design and characterization but are not production tested.
- (2) C<sub>LOAD</sub> is the effective external single-ended load capacitance between each output pin and ground.
- (3) R<sub>LOAD</sub> is the differential load resistance between the LVDS output pair.
- (4) At higher frequencies, t<sub>PDI</sub> is greater than one clock period and overall latency = ADC latency + 1.
- (5) Data valid refers to a logic high of 1.26V and a logic low of 0.54V.
- (6) For f<sub>S</sub> > 200MSPS, it is recommended to use an external clock for data capture instead of the device output clock signal (CLKOUT).

Table 1. LVDS Timing Across Sampling Frequencies

SAMPLING FREQUENCY (MSPS)	SETUP TIME (ns)			HOLD TIME (ns)		
	MIN	TYP	MAX	MIN	TYP	MAX
80	4.5	5.2		0.35	0.6	
65	5.5	6.5		0.35	0.6	

Table 2. CMOS Timing Across Sampling Frequencies

SAMPLING FREQUENCY (MSPS)	TIMING SPECIFIED WITH RESPECT TO OUTPUT CLOCK								
	$t_{\text{SETUP}}$ (ns)			$t_{\text{HOLD}}$ (ns)			$t_{\text{PDI}}$ (ns)		
	MIN	TYP	MAX	MIN	TYP	MAX	MIN	TYP	MAX
80	4.8	5.5		5.7	6.5		4	5.5	7
65	6.0	7.0		7.0	8.0		4	5.5	7

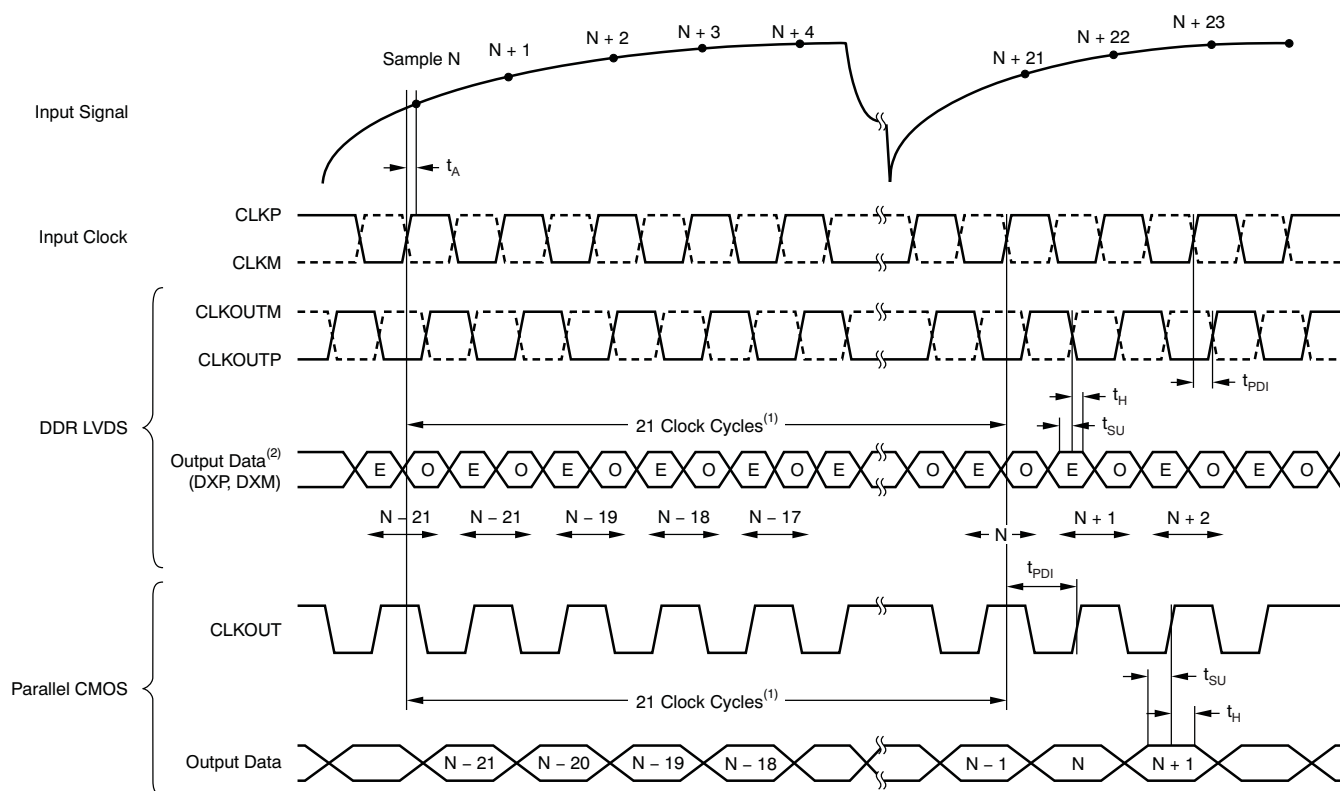

(1) At higher sampling frequencies,  $t_{\text{PDI}}$  is greater than one clock cycle, which then makes the overall latency = ADC latency + 1.

(2) E = Even bits (D0, D2, D4, etc). O = Odd bits (D1, D3, D5, etc).

Figure 5. Latency Diagram

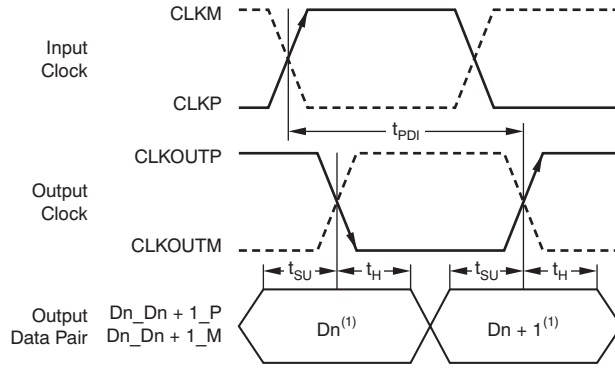

(1)  $D_n$  = bits D0, D2, D4, etc.  $D_{n+1}$  = Bits D1, D3, D5, etc.

**Figure 6. LVDS Mode Timing**

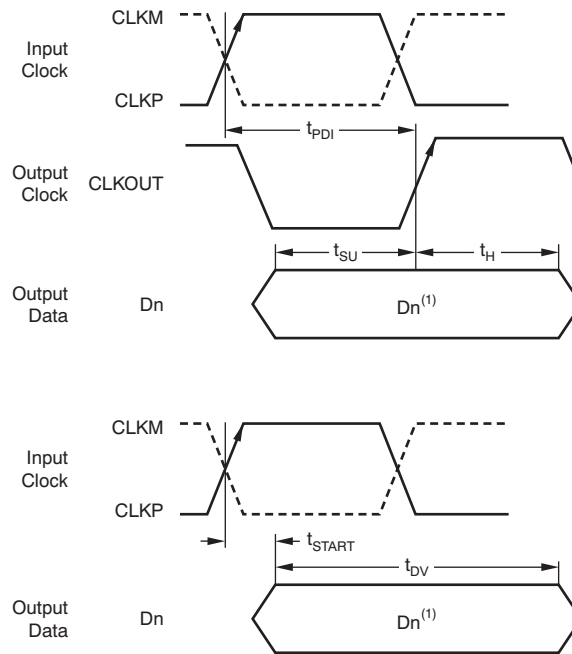

$D_n$  = bits D0, D1, D2, etc.

**Figure 7. CMOS Mode Timing**

## DEVICE CONFIGURATION

The ADS41B25 has several modes that can be configured using a serial programming interface, as described in [Table 3](#), [Table 4](#), and [Table 5](#). In addition, the device has two dedicated parallel pins to quickly configure commonly-used functions. The parallel pins are DFS (analog four-level control pin) and OE (digital control pin). The analog control pins can be easily configured using a simple resistor divider (with 10% tolerance resistors).

**Table 3. DFS: Analog Control Pin**

VOLTAGE APPLIED ON DFS	DESCRIPTION (Data Format/Output Interface)
0, +100mV/0mV	Twos complement/DDR LVDS
(3/8) AVDD ± 100mV	Twos complement/parallel CMOS
(5/8) AVDD ± 100mV	Offset binary/parallel CMOS
AVDD, 0mV/–100mV	Offset binary/DDR LVDS

**Table 4. OE: Digital Control Pin**

VOLTAGE APPLIED ON OE	DESCRIPTION
0	Output data buffers disabled
AVDD	Output data buffers enabled

When the serial interface is not used, the SDATA pin can also be used as a digital control pin to place the device in standby mode. To enable this, the RESET pin must be tied high. In this mode, SEN and SCLK do not have any alternative functions. Keep SEN tied high and SCLK tied low on the board.

**Table 5. SDATA: Digital Control Pin**

VOLTAGE APPLIED ON SDATA	DESCRIPTION
0	Normal operation
Logic high	Device enters standby

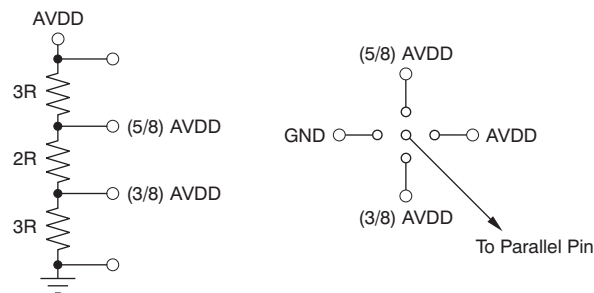

**Figure 8. Simplified Diagram to Configure DFS Pin**

## SERIAL INTERFACE

The analog-to-digital converter (ADC) has a set of internal registers that can be accessed by the serial interface formed by the SEN (serial interface enable), SCLK (serial interface clock), and SDATA (serial interface data) pins. Serial shift of bits into the device is enabled when SEN is low. Serial data SDATA are latched at every falling edge of SCLK when SEN is active (low). The serial data are loaded into the register at every 16th SCLK falling edge when SEN is low. If the word length exceeds a multiple of 16 bits, the excess bits are ignored. Data can be loaded in multiples of 16-bit words within a single active SEN pulse. The first eight bits form the register address and the remaining eight bits are the register data. The interface can work with SCLK frequency from 20MHz down to very low speeds (a few Hertz) and also with non-50% SCLK duty cycle.

### Register Initialization

After power-up, the internal registers must be initialized to the default values. This initialization can be accomplished in one of two ways:

1. Either through hardware reset by applying a high pulse on RESET pin (of width greater than 10ns), as shown in Figure 9; or
2. By applying a software reset. When using the serial interface, set the RESET bit high. This setting initializes the internal registers to the default values and then self-resets the RESET bit low. In this case, the RESET pin is kept low.

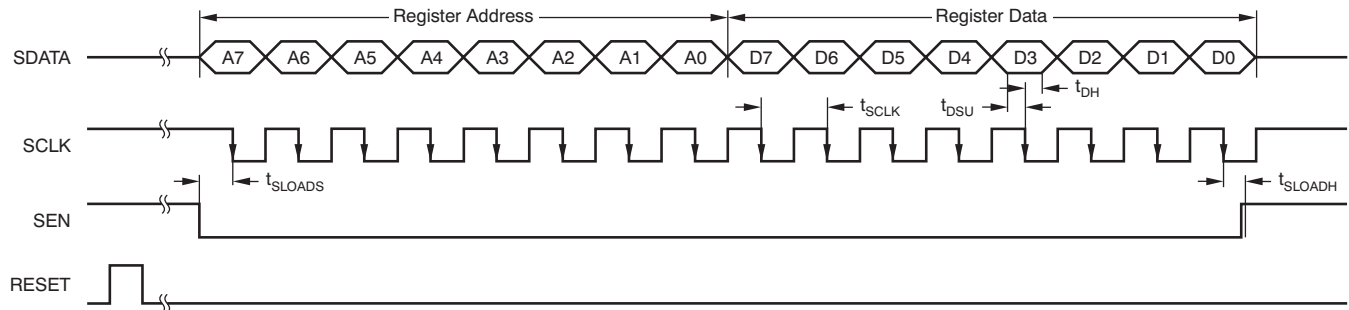

Figure 9. Serial Interface Timing

## SERIAL INTERFACE TIMING CHARACTERISTICS

Typical values at +25°C, minimum and maximum values across the full temperature range: T<sub>MIN</sub> = -40°C to T<sub>MAX</sub> = +85°C, AVDD = 1.8V, and DRVDD = 1.8V, unless otherwise noted.

PARAMETER		MIN	TYP	MAX	UNIT
f <sub>SCLK</sub>	SCLK frequency (equal to 1/t <sub>SCLK</sub> )	> dc		20	MHz
t <sub>SLOADS</sub>	SEN to SCLK setup time	25			ns
t <sub>SLOADH</sub>	SCLK to SEN hold time	25			ns
t <sub>DSU</sub>	SDATA setup time	25			ns
t <sub>DH</sub>	SDATA hold time	25			ns



## Serial Register Readout

The serial register readout function allows the contents of the internal registers to be read back on the OVR\_SDOOUT pin. This readback may be useful as a diagnostic check to verify the serial interface communication between the external controller and the ADC.

After power-up and device reset, the OVR\_SDOOUT pin functions as an over-range indicator pin by default. When the readout mode is enabled, OVR\_SDOOUT outputs the contents of the selected register serially, as shown in Figure 10:

1. Set the READOUT register bit to '1'. This setting puts the device in serial readout mode and disables any further writes to the internal registers **except** the register at address 0. Note that the READOUT bit itself is also located in register 0. The device can exit readout mode by writing READOUT = 0. Only the contents of the register at address 0 cannot be read in the register readout mode.
2. Initiate a serial interface cycle specifying the address of the register (A7 to A0) whose content has to be read.
3. The device serially outputs the contents (D7 to D0) of the selected register on the OVR\_SDOOUT pin.
4. The external controller can latch the contents at the falling edge of SCLK.
5. To exit the serial readout mode, the reset register bit READOUT = 0 enables writes into all registers of the device. At this point, the OVR\_SDOOUT pin becomes an over-range indicator pin.

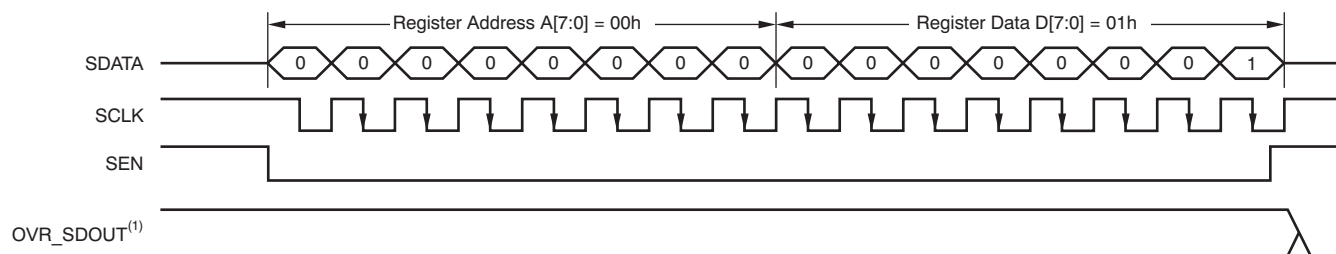

a) Enable Serial Readout (READOUT = 1)

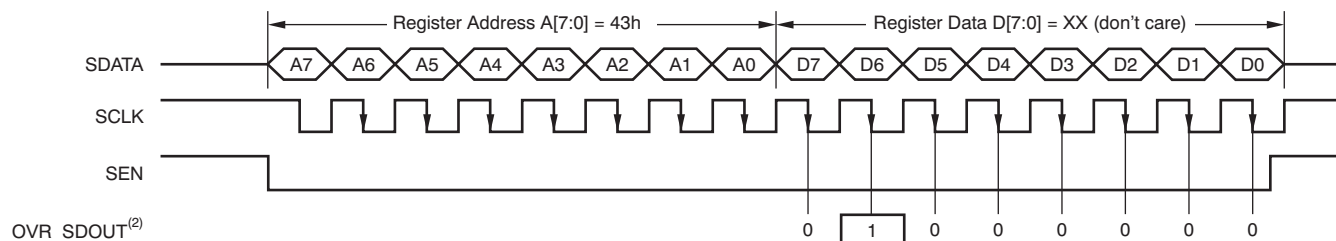

b) Read Contents of Register 43h. This Register Has Been Initialized with 40h (device is put in global power-down mode).

(1) The OVR\_SDOOUT pin functions as OVR (READOUT = 0).

(2) The OVR\_SDOOUT pin functions as a serial readout (READOUT = 1).

**Figure 10. Serial Readout Timing Diagram**

### RESET TIMING CHARACTERISTICS

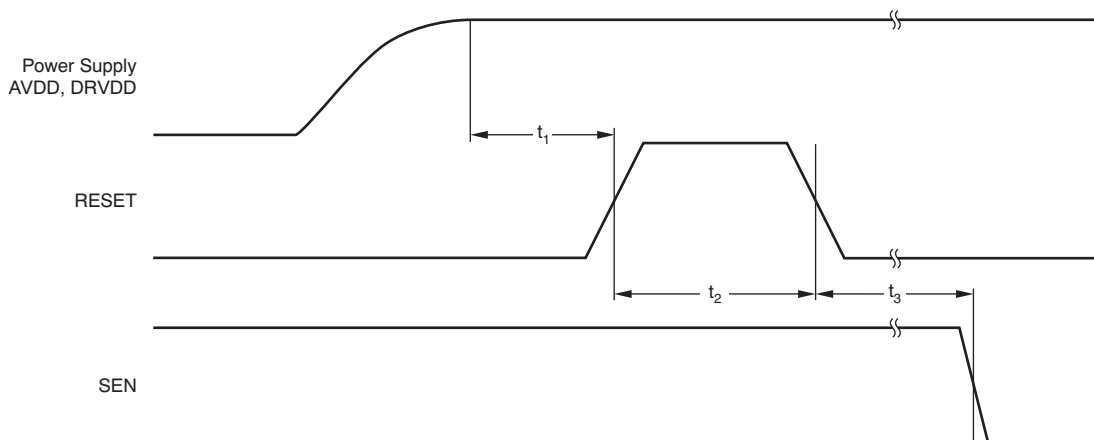

NOTE: A high pulse on the RESET pin is required in the serial interface mode in case of initialization through hardware reset. For parallel interface operation, RESET must be permanently tied high.

Figure 11. Reset Timing Diagram

### RESET TIMING REQUIREMENTS

Typical values at +25°C and minimum and maximum values across the full temperature range:  $T_{MIN} = -40^{\circ}C$  to  $T_{MAX} = +85^{\circ}C$ , unless otherwise noted.

PARAMETER	TEST CONDITIONS	MIN	TYP	MAX	UNIT
$t_1$	Power-on delay Delay from power-up of AVDD and DRVDD to RESET pulse active	1			ms
$t_2$	Reset pulse width Pulse width of active RESET signal that resets the serial registers	10			ns
				1 <sup>(1)</sup>	μs
$t_3$	Delay from RESET disable to SEN active	100			ns

(1) The reset pulse is needed only when using the serial interface configuration. If the pulse width is greater than 1μs, the device could enter the parallel configuration mode briefly and then return back to serial interface mode.

## SERIAL REGISTER MAP

Table 6 summarizes the functions supported by the serial interface.

**Table 6. Serial Interface Register Map<sup>(1)</sup>**

REGISTER ADDRESS	DEFAULT VALUE AFTER RESET	REGISTER DATA							
		D7	D6	D5	D4	D3	D2	D1	D0
A[7:0] (Hex)	D[7:0] (Hex)								
00	00	0	0	0	0	0	0	RESET	READOUT
01	00	LVDS SWING						0	0
03	00	0	0	0	0	0	0	HIGH PERF MODE 1	
25	50	GAIN				0	TEST PATTERNS		
26	00	0	0	0	0	0	0	LVDS CLKOUT STRENGTH	LVDS DATA STRENGTH
3D	00	DATA FORMAT		EN OFFSET CORR	0	0	0	0	0
3F	00	0	0	CUSTOM PATTERN D[11:6]					
40	00	CUSTOM PATTERN D[5:0]						0	0
41	00	LVDS CMOS		CMOS CLKOUT STRENGTH		EN CLKOUT RISE	CLKOUT RISE POSN		EN CLKOUT FALL
42	08	CLKOUT FALL POSN		0	0	1	STBY	0	0
43	00	0	PDN GLOBAL	0	PDN OBUF	0	0	EN LVDS SWING	
4A	00	0	0	0	0	0	0	0	HIGH PERF MODE 2
BF	00	OFFSET PEDESTAL				0	0	0	0
CF	00	FREEZE OFFSET CORR	0	OFFSET CORR TIME CONSTANT				0	0
DF	00	0	0	LOW SPEED		0	0	0	0

(1) Multiple functions in a register can be programmed in a single write operation.

### DESCRIPTION OF SERIAL REGISTERS

For best performance, two special mode register bits must be enabled:

- HI PERF MODE 1 and
- HI PERF MODE 2

#### Register Address 00h (Default = 00h)

7	6	5	4	3	2	1	0
0	0	0	0	0	0	RESET	READOUT

**Bits[7:2] Always write '0'**

**Bit 1 RESET: Software reset applied**

This bit resets all internal registers to the default values and self-clears to 0 (default = 1).

**Bit 0 READOUT: Serial readout**

This bit sets the serial readout of the registers.

0 = Serial readout of registers disabled; the OVR\_SDOOUT pin functions as an over-voltage indicator.

1 = Serial readout enabled; the OVR\_SDOOUT pin functions as a serial data readout.

**Register Address 01h (Default = 00h)**

7	6	5	4	3	2	1	0
LVDS SWING						0	0

**Bits[7:2] LVDS SWING: LVDS swing programmability<sup>(1)</sup>**

- 000000 = Default LVDS swing;  $\pm 350\text{mV}$  with external  $100\Omega$  termination
- 011011 = LVDS swing *increases* to  $\pm 410\text{mV}$
- 110010 = LVDS swing *increases* to  $\pm 465\text{mV}$
- 010100 = LVDS swing *increases* to  $\pm 570\text{mV}$
- 111110 = LVDS swing *decreases* to  $\pm 200\text{mV}$
- 001111 = LVDS swing *decreases* to  $\pm 125\text{mV}$

**Bits[1:0] Always write '0'**

(1) The EN LVDS SWING register bits must be set to enable LVDS swing control.

**Register Address 03h (Default = 00h)**

7	6	5	4	3	2	1	0
0	0	0	0	0	0	HI PERF MODE 1	

**Bits[7:2] Always write '0'**

**Bits[1:0] HI PERF MODE 1: High performance mode 1**

- 00 = Default performance after reset
- 01 = Do not use
- 10 = Do not use
- 11 = For best performance across sampling clock and input signal frequencies, set the HIGH PERF MODE 1 bits

**Register Address 25h (Default = 50h)**

7	6	5	4	3	2	1	0
GAIN				0	TEST PATTERNS		

**Bits[7:4] GAIN: Gain programmability**

These bits set the gain programmability in 0.5dB steps.

0000, 0001, 0010, 0011, 0100 = Do not use

0101 = 0dB gain (default after reset)

0110 = 0.5dB gain

0111 = 1dB gain

1000 = 1.5dB gain

1001 = 2dB gain

1010 = 2.5dB gain

1011 = 3dB gain

1100 = 3.5dB gain

**Bit 3 Always write '0'**
**Bits[2:0] TEST PATTERNS: Data capture**

These bits verify data capture.

000 = Normal operation

001 = Outputs all 0s

010 = Outputs all 1s

011 = Outputs toggle pattern

Output data D[11:0] is an alternating sequence of *010101010101* and *101010101010*.

100 = Outputs digital ramp

Output data increments by one LSB (12-bit) every fourth clock cycle from code 0 to code 4095

101 = Output custom pattern (use registers 3Fh and 40h for setting the custom pattern)

110 = Unused

111 = Unused

**Register Address 26h (Default = 00h)**

7	6	5	4	3	2	1	0
0	0	0	0	0	0	LVDS CLKOUT STRENGTH	LVDS DATA STRENGTH

**Bits[7:2] Always write '0'**

**Bit 1 LVDS CLKOUT STRENGTH: LVDS output clock buffer strength**

This bit determines the external termination to be used with the LVDS output clock buffer.  
 0 = 100Ω external termination (default strength)  
 1 = 50Ω external termination (2x strength)

**Bit 0 LVDS DATA STRENGTH: LVDS data buffer strength**

This bit determines the external termination to be used with all of the LVDS data buffers.  
 0 = 100Ω external termination (default strength)  
 1 = 50Ω external termination (2x strength)

**Register Address 3Dh (Default = 00h)**

7	6	5	4	3	2	1	0
DATA FORMAT		EN OFFSET CORR	0	0	0	0	0

**Bits[7:6] DATA FORMAT: Data format selection**

These bits selects the data format.  
 00 = The DFS pin controls data format selection  
 10 = Twos complement  
 11 = Offset binary

**Bit 5 ENABLE OFFSET CORR: Offset correction setting**

This bit sets the offset correction.  
 0 = Offset correction disabled  
 1 = Offset correction enabled

**Bits[4:0] Always write '0'**

**Register Address 3Fh (Default = 00h)**

7	6	5	4	3	2	1	0
0	0	CUSTOM PATTERN D11	CUSTOM PATTERN D10	CUSTOM PATTERN D9	CUSTOM PATTERN D8	CUSTOM PATTERN D7	CUSTOM PATTERN D6

**Bits[7:6] Always write '0'**

**Bits[5:0] CUSTOM PATTERN**

These bits set the custom pattern.

**Register Address 40h (Default = 00h)**

7	6	5	4	3	2	1	0
CUSTOM PATTERN D5	CUSTOM PATTERN D4	CUSTOM PATTERN D3	CUSTOM PATTERN D2	CUSTOM PATTERN D1	CUSTOM PATTERN D0	0	0

**Bits[7:2] CUSTOM PATTERN**

These bits set the custom pattern.

**Bits[1:0] Always write '0'**

**Register Address 41h (Default = 00h)**

7	6	5	4	3	2	1	0
LVDS CMOS		CMOS CLKOUT STRENGTH		EN CLKOUT RISE	CLKOUT RISE POSN		EN CLKOUT FALL

**Bits[7:6] LVDS CMOS: Interface selection**

These bits select the interface.

00, 10 = The DFS pin controls the selection of either LVDS or CMOS interface

01 = DDR LVDS interface

11 = Parallel CMOS interface

**Bits[5:4] CMOS CLKOUT STRENGTH**

Controls strength of CMOS output clock only.

00 = Maximum strength (recommended and used for specified timings)

01 = Medium strength

10 = Low strength

11 = Very low strength

**Bit 3 ENABLE CLKOUT RISE**

0 = Disables control of output clock rising edge

1 = Enables control of output clock rising edge

**Bits[2:1] CLKOUT RISE POSN: CLKOUT rise control**

Controls position of output clock rising edge

LVDS interface:

00 = Default position (timings are specified in this condition)

01 = Setup reduces by 500ps, hold increases by 500ps

10 = Data transition is aligned with rising edge

11 = Setup reduces by 200ps, hold increases by 200ps

CMOS interface:

00 = Default position (timings are specified in this condition)

01 = Setup reduces by 100ps, hold increases by 100ps

10 = Setup reduces by 200ps, hold increases by 200ps

11 = Setup reduces by 1.5ns, hold increases by 1.5ns

**Bit 0 ENABLE CLKOUT FALL**

0 = Disables control of output clock fall edge

1 = Enables control of output clock fall edge

**Register Address 42h (Default = 08h)**

7	6	5	4	3	2	1	0
CLKOUT FALL POSN		0	0	1	STBY	0	0

**Bits[7:6] CLKOUT FALL POSN**

Controls position of output clock falling edge

LVDS interface:

00 = Default position (timings are specified in this condition)

01 = Setup reduces by 400ps, hold increases by 400ps

10 = Data transition is aligned with rising edge

11 = Setup reduces by 200ps, hold increases by 200ps

CMOS interface:

00 = Default position (timings are specified in this condition)

01 = Falling edge is advanced by 100ps

10 = Falling edge is advanced by 200ps

11 = Falling edge is advanced by 1.5ns

**Bits[5:4] Always write '0'****Bit 3 Always write '1'****Bit 2 STBY: Standby mode**

This bit sets the standby mode.

0 = Normal operation

1 = Only the ADC and output buffers are powered down; internal reference is active; wake-up time from standby is fast

**Bits[1:0] Always write '0'**



**Register Address 43h (Default = 00h)**

7	6	5	4	3	2	1	0
0	PDN GLOBAL	0	PDN OBUF	0	0	EN LVDS SWING	

**Bit 0** Always write '0'

**Bit 6** **PDN GLOBAL: Power-down**

This bit sets the state of operation.

0 = Normal operation

1 = Total power down; the ADC, internal references, and output buffers are powered down; slow wake-up time.

**Bit 5** Always write '0'

**Bit 4** **PDN OBUF: Power-down output buffer**

This bit set the output data and clock pins.

0 = Output data and clock pins enabled

1 = Output data and clock pins powered down and put in high- impedance state

**Bits[3:2]** Always write '0'

**Bits[1:0]** **EN LVDS SWING: LVDS swing control**

00 = LVDS swing control using LVDS SWING register bits is disabled

01, 10 = Do not use

11 = LVDS swing control using LVDS SWING register bits is enabled

**Register Address 4Ah (Default = 00h)**

7	6	5	4	3	2	1	0
0	0	0	0	0	0	0	HI PERF MODE 2

**Bits[7:1]** Always write '0'

**Bit[0]** **HI PERF MODE 2: High performance mode 2**

This bit is recommended for high input signal frequencies greater than 230MHz.

0 = Default performance after reset

1 = For best performance with high-frequency input signals, set the HIGH PERF MODE 2 bit

**Register Address BFh (Default = 00h)**

7	6	5	4	3	2	1	0
OFFSET PEDESTAL				0	0	0	0

**Bits[7:4] OFFSET PEDESTAL**

These bits set the offset pedestal.

When the offset correction is enabled, the final converged value after the offset is corrected is the ADC mid-code value. A pedestal can be added to the final converged value by programming these bits.

VALUE	PEDESTAL
0111	7LSB
0110	6LSB
0101	5LSB
—	—
0000	0LSB
—	—
1111	-1LSB
1110	-2LSB
—	—
1000	-8LSB

**Bits[3:0] Always write '0'**

**Register Address CFh (Default = 00h)**

7	6	5	4	3	2	1	0
FREEZE OFFSET CORR	0	OFFSET CORR TIME CONSTANT				0	0

**Bit 7 FREEZE OFFSET CORR**

This bit sets the freeze offset correction.

0 = Estimation of offset correction is not frozen (bit EN OFFSET CORR must be set)

1 = Estimation of offset correction is frozen (bit EN OFFSET CORR must be set). When frozen, the last estimated value is used for offset correction every clock cycle; see the [OFFSET CORRECTION](#) section.

**Bit 6 Always write '0'**
**Bits[5:2] OFFSET CORR TIME CONSTANT**

These bits set the offset correction time constant for the correction loop time constant in number of clock cycles.

VALUE	TIME CONSTANT (Number of Clock Cycles)
0000	1M
0001	2M
0010	4M
0011	8M
0100	16M
0101	32M
0110	64M
0111	128M
1000	256M
1001	512M
1010	1G
1011	2G

**Bits[1:0] Always write '0'**
**Register Address DFh (Default = 00h)**

7	6	5	4	3	2	1	0
0	0	LOW SPEED		0	0	0	0

**Bits[7:6] Always write '0'**
**Bits[5:4] LOW SPEED: Low-speed mode**

00, 01, 10 = Low-speed mode disabled (default state after reset); this setting is recommended for sampling rates greater than 80MSPS.

11 = Low-speed mode enabled; this setting is recommended for sampling rates less than or equal to 80MSPS.

**Bits[3:0] Always write '0'**

**TYPICAL CHARACTERISTICS**

At +25°C, AVDD = 1.8V, AVDD\_BUF = 3.3V, DRVDD = 1.8V, maximum rated sampling frequency, sine wave input clock, 1.5V<sub>pp</sub> differential clock amplitude, 50% clock duty cycle, -1dBFS differential analog input, DDR LVDS output interface, and 32k-point FFT, unless otherwise noted.

**FFT FOR 10MHz INPUT SIGNAL**

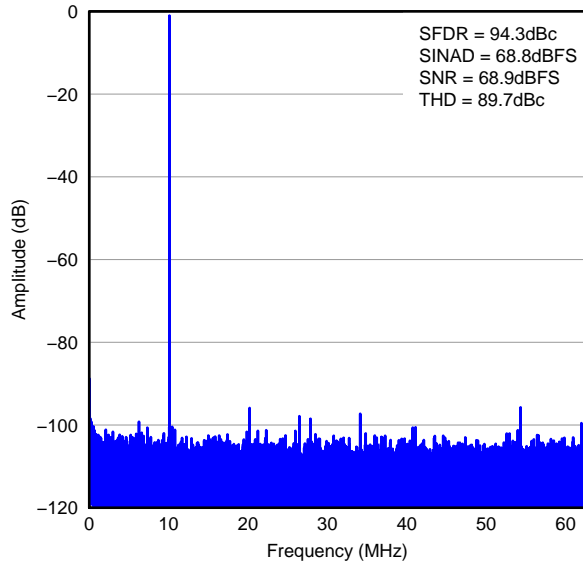

**Figure 12.**

**FFT FOR 70MHz INPUT SIGNAL**

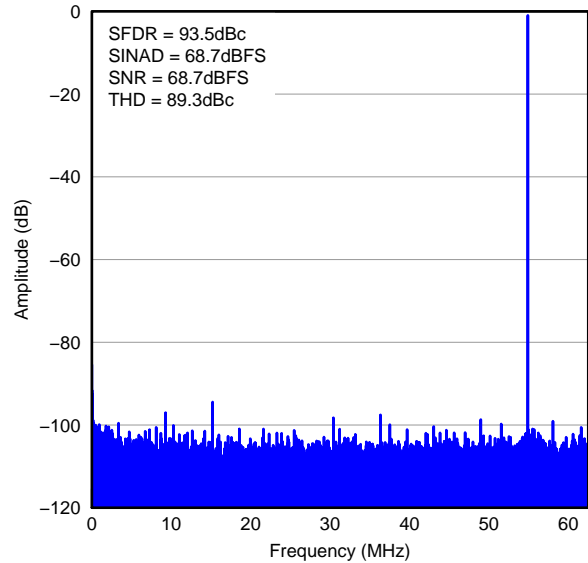

**Figure 13.**

**FFT FOR 170MHz INPUT SIGNAL**

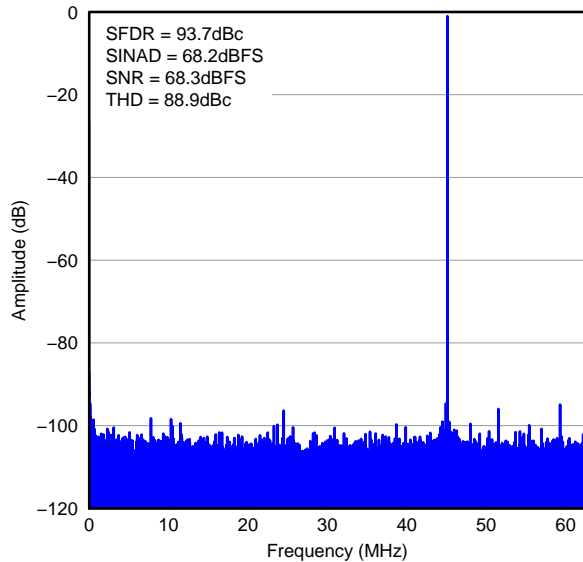

**Figure 14.**

**FFT FOR 300MHz INPUT SIGNAL**

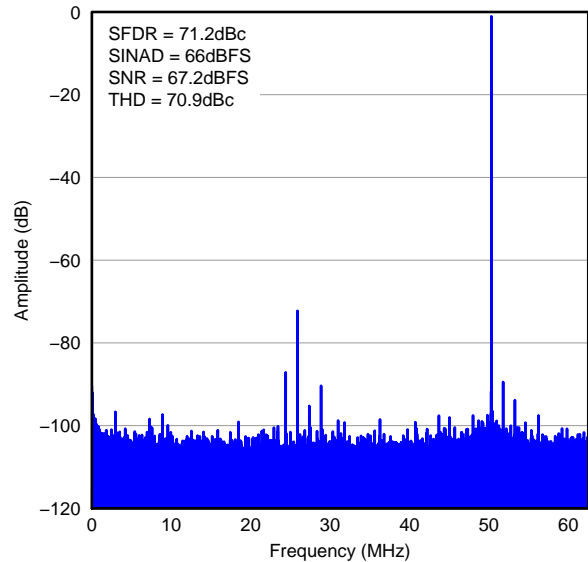

**Figure 15.**

**TYPICAL CHARACTERISTICS (continued)**

At +25°C, AVDD = 1.8V, AVDD\_BUF = 3.3V, DRVDD = 1.8V, maximum rated sampling frequency, sine wave input clock, 1.5V<sub>PP</sub> differential clock amplitude, 50% clock duty cycle, -1dBFS differential analog input, DDR LVDS output interface, and 32k-point FFT, unless otherwise noted.

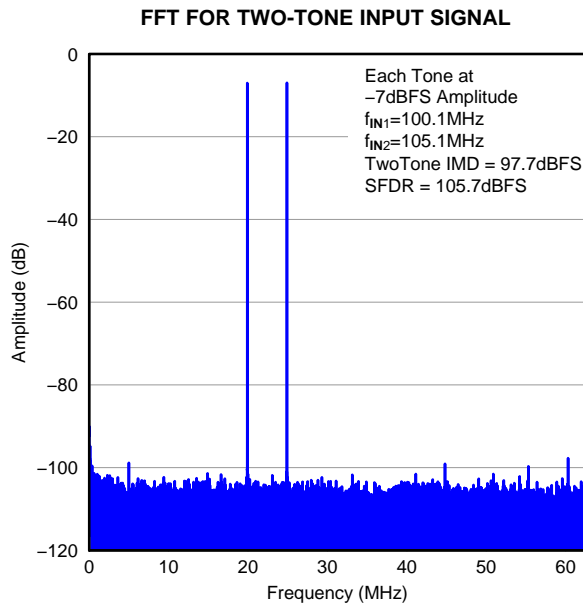

Figure 16.

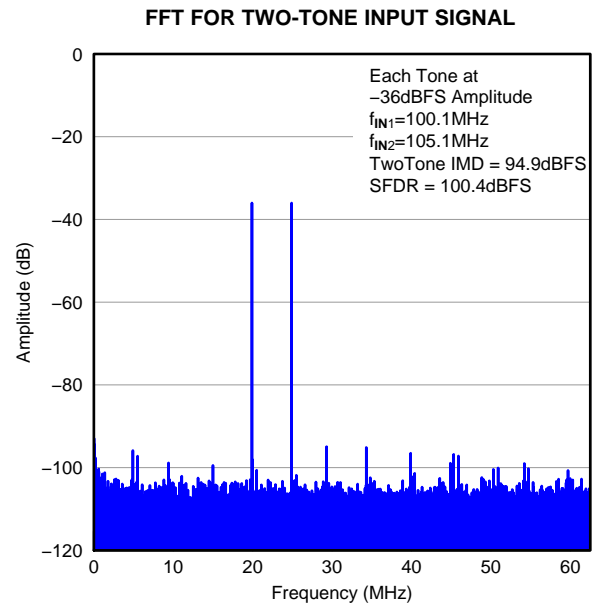

Figure 17.

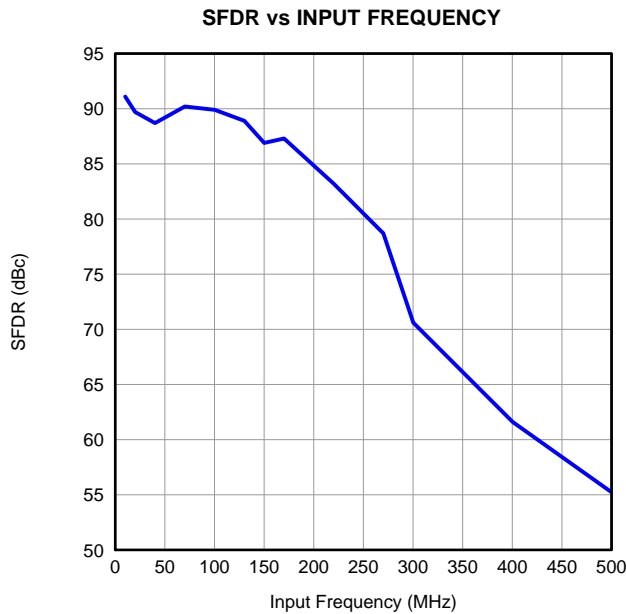

Figure 18.

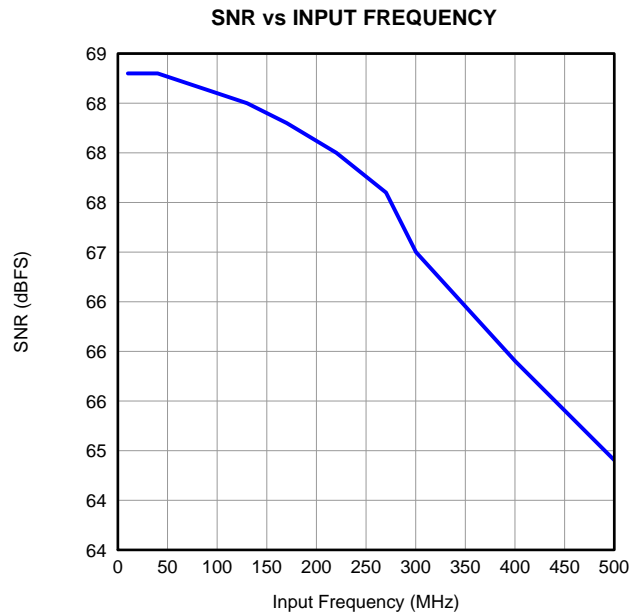

Figure 19.

**TYPICAL CHARACTERISTICS (continued)**

At +25°C, AVDD = 1.8V, AVDD\_BUF = 3.3V, DRVDD = 1.8V, maximum rated sampling frequency, sine wave input clock, 1.5V<sub>PP</sub> differential clock amplitude, 50% clock duty cycle, -1dBFS differential analog input, DDR LVDS output interface, and 32k-point FFT, unless otherwise noted.

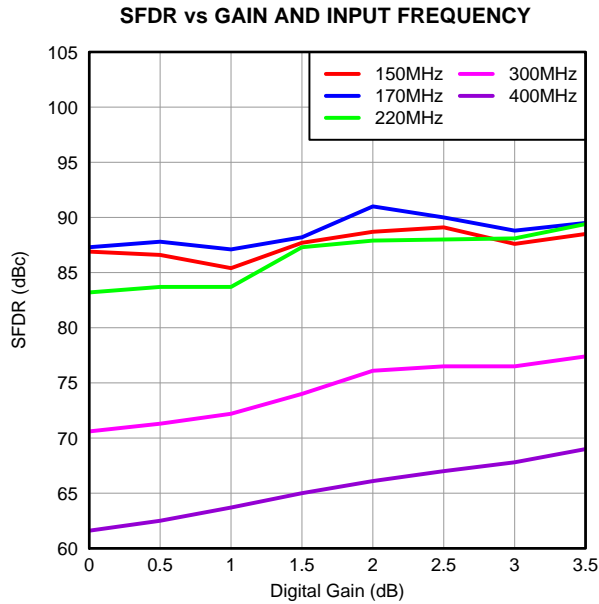

Figure 20.

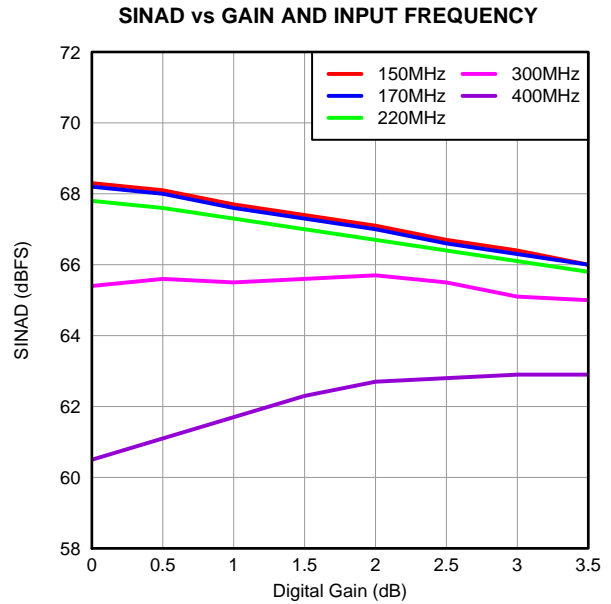

Figure 21.

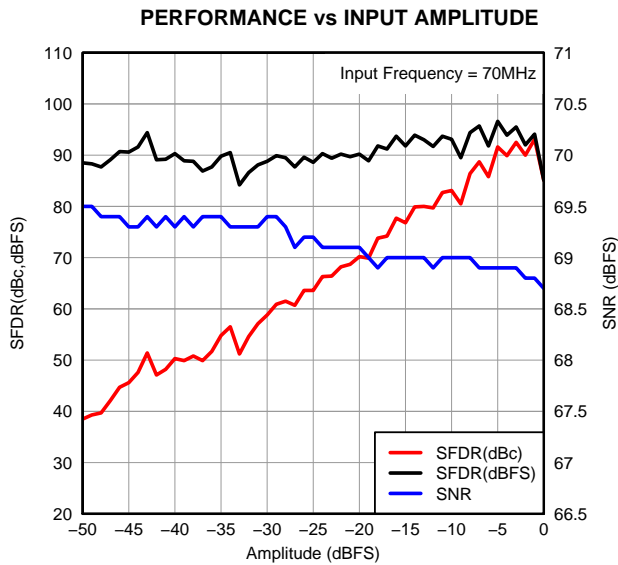

Figure 22.

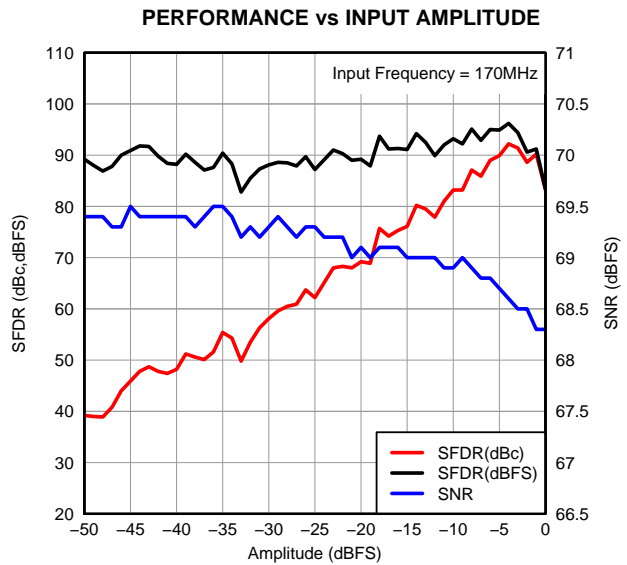

Figure 23.

**TYPICAL CHARACTERISTICS (continued)**

At +25°C, AVDD = 1.8V, AVDD\_BUF = 3.3V, DRVDD = 1.8V, maximum rated sampling frequency, sine wave input clock, 1.5V<sub>PP</sub> differential clock amplitude, 50% clock duty cycle, -1dBFS differential analog input, DDR LVDS output interface, and 32k-point FFT, unless otherwise noted.

**PERFORMANCE vs INPUT COMMON-MODE VOLTAGE**

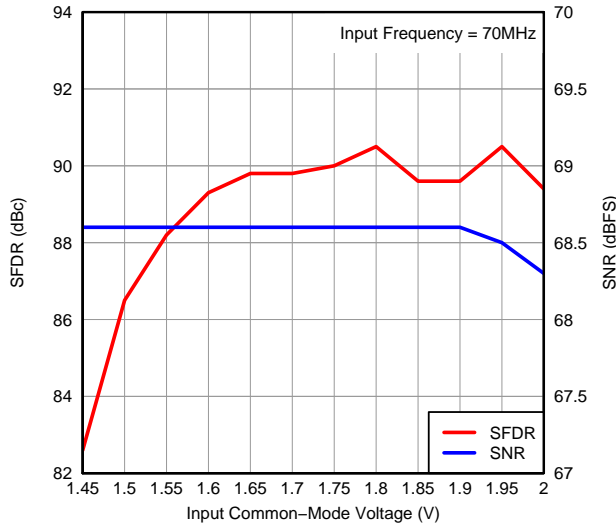

Figure 24.

**SFDR ACROSS TEMPERATURE vs AVDD SUPPLY**

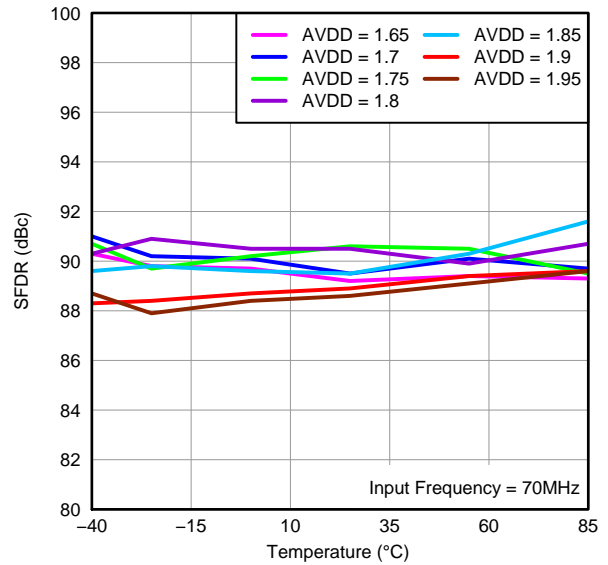

Figure 25.

**SNR ACROSS TEMPERATURE vs AVDD SUPPLY**

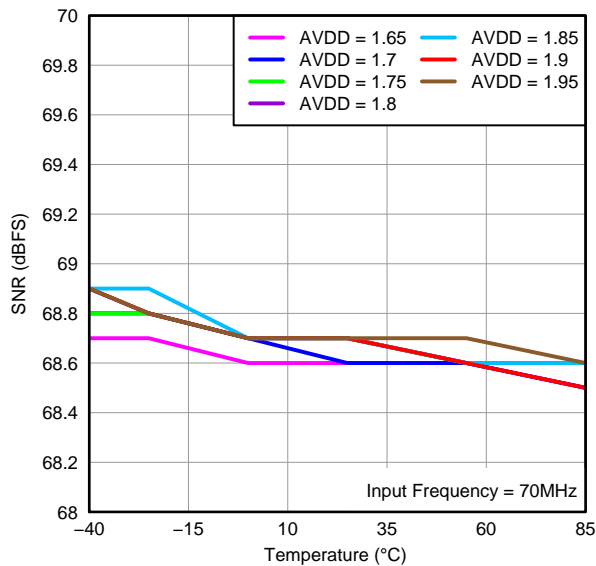

Figure 26.

**PERFORMANCE vs DRVDD SUPPLY VOLTAGE**

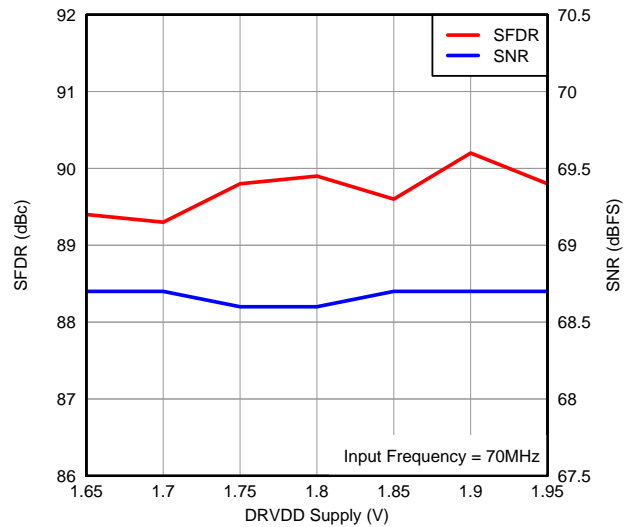

Figure 27.

**TYPICAL CHARACTERISTICS (continued)**

At +25°C, AVDD = 1.8V, AVDD\_BUF = 3.3V, DRVDD = 1.8V, maximum rated sampling frequency, sine wave input clock, 1.5V<sub>PP</sub> differential clock amplitude, 50% clock duty cycle, -1dBFS differential analog input, DDR LVDS output interface, and 32k-point FFT, unless otherwise noted.

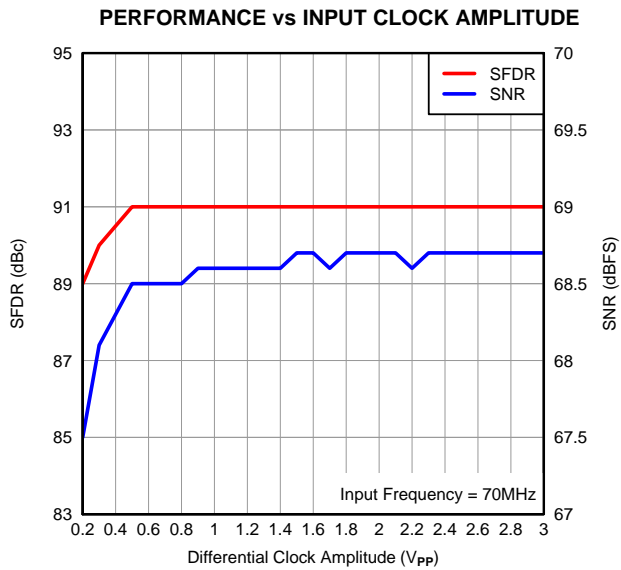

Figure 28.

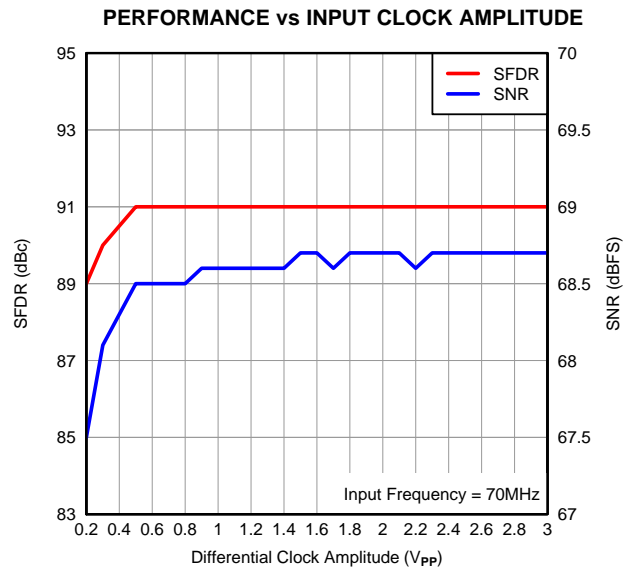

Figure 29.

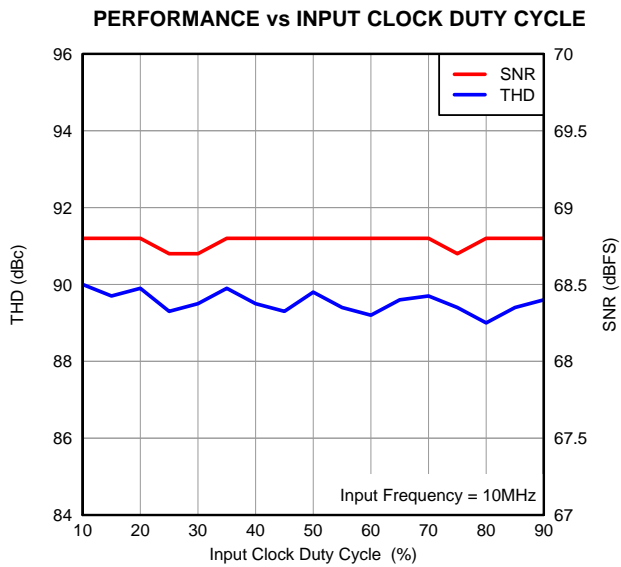

Figure 30.

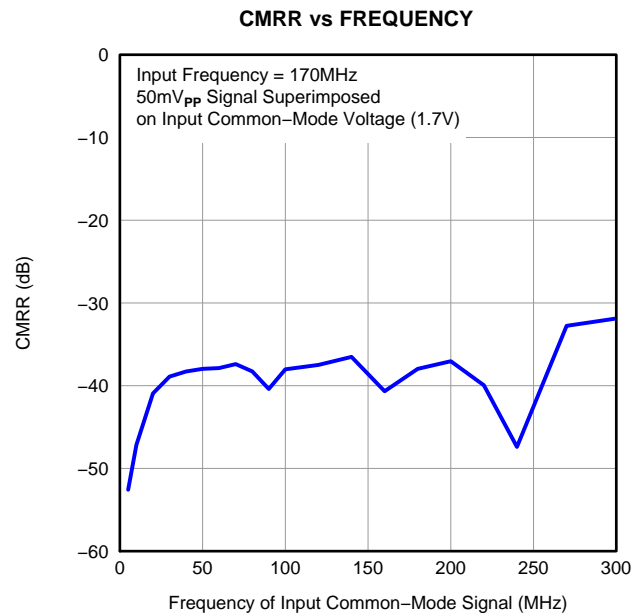

Figure 31.



**TYPICAL CHARACTERISTICS (continued)**

At +25°C, AVDD = 1.8V, AVDD\_BUF = 3.3V, DRVDD = 1.8V, maximum rated sampling frequency, sine wave input clock, 1.5V<sub>PP</sub> differential clock amplitude, 50% clock duty cycle, -1dBFS differential analog input, DDR LVDS output interface, and 32k-point FFT, unless otherwise noted.

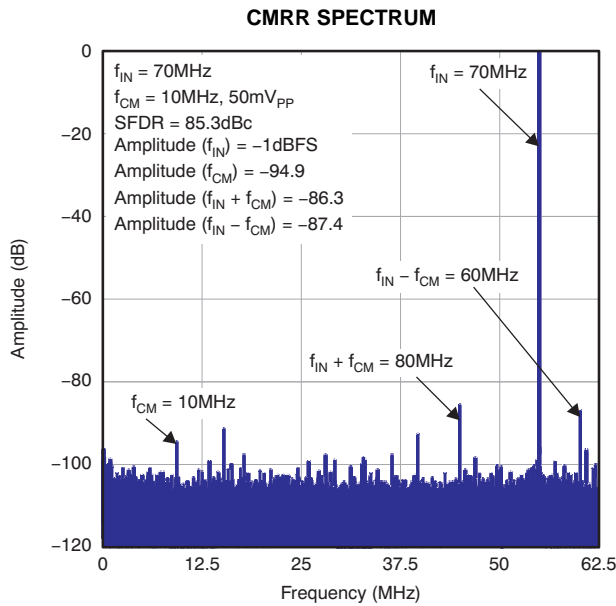

Figure 32.

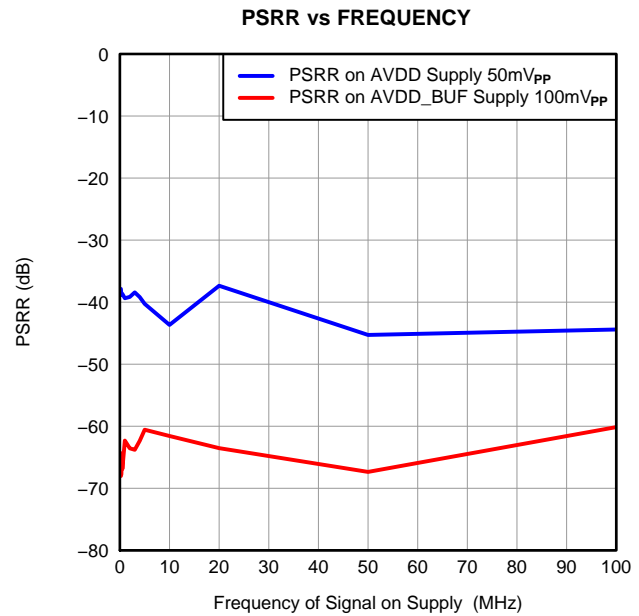

Figure 33.

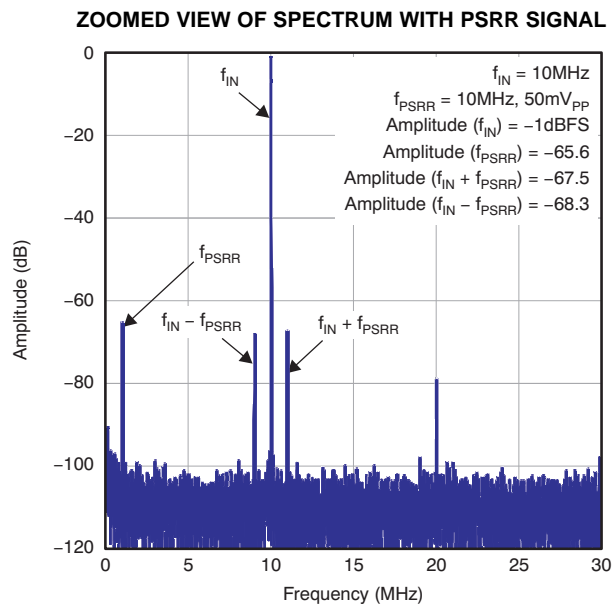

Figure 34.

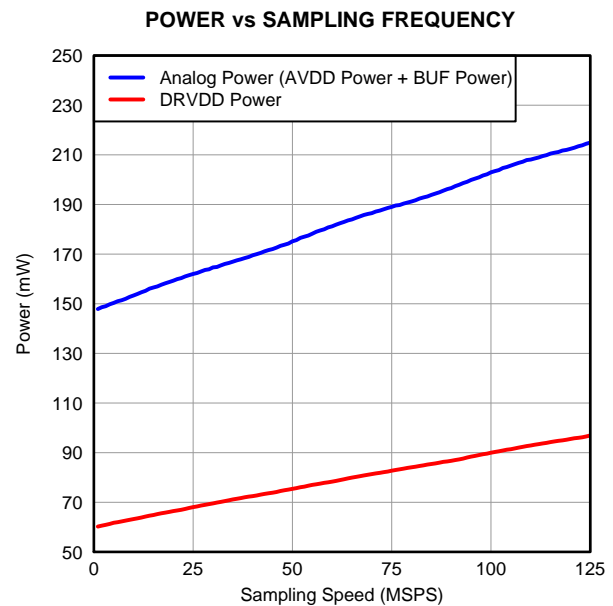
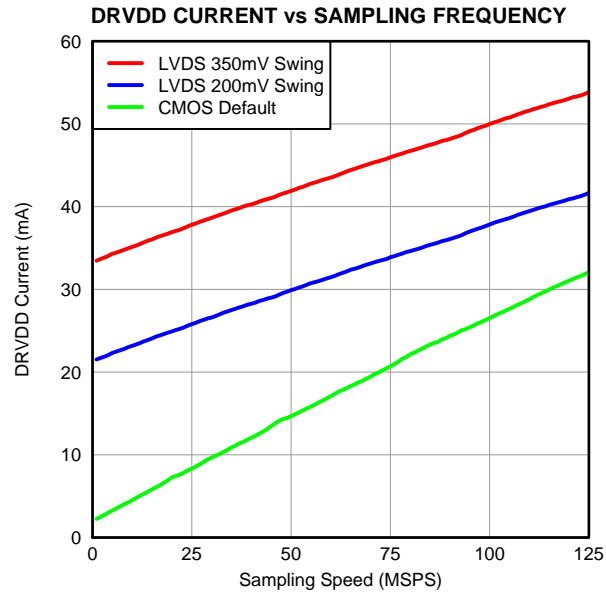

Figure 35.

**TYPICAL CHARACTERISTICS (continued)**

At +25°C, AVDD = 1.8V, AVDD\_BUF = 3.3V, DRVDD = 1.8V, maximum rated sampling frequency, sine wave input clock, 1.5V<sub>PP</sub> differential clock amplitude, 50% clock duty cycle, -1dBFS differential analog input, DDR LVDS output interface, and 32k-point FFT, unless otherwise noted.



**Figure 36.**

**TYPICAL CHARACTERISTICS: CONTOUR**

At +25°C, AVDD = 1.8V, AVDD\_BUF = 3.3V, DRVDD = 1.8V, maximum rated sampling frequency, sine wave input clock, 1.5V<sub>pp</sub> differential clock amplitude, 50% clock duty cycle, -1dBFS differential analog input, DDR LVDS output interface, and 32k-point FFT, unless otherwise noted.

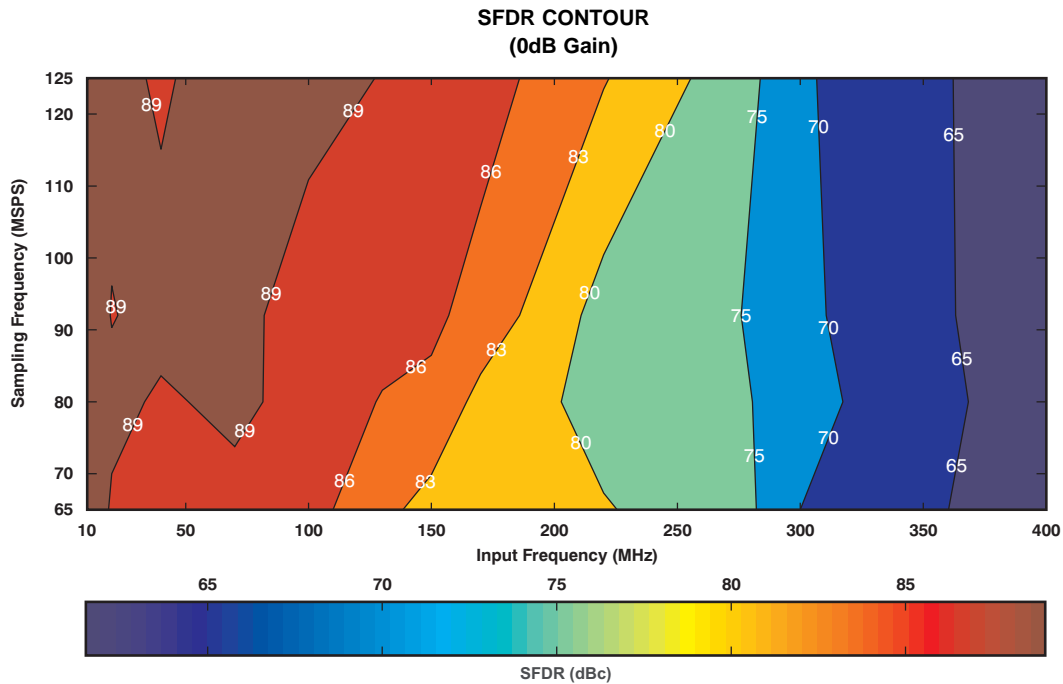

Figure 37.

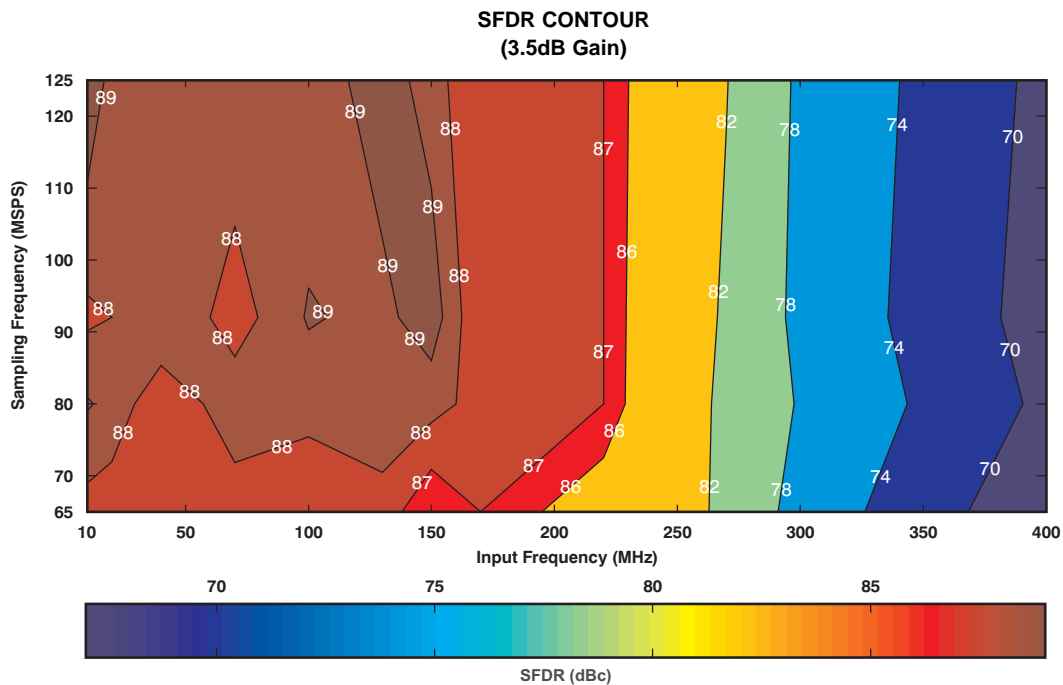

Figure 38.

**TYPICAL CHARACTERISTICS: CONTOUR (continued)**

At +25°C, AVDD = 1.8V, AVDD\_BUF = 3.3V, DRVDD = 1.8V, maximum rated sampling frequency, sine wave input clock, 1.5V<sub>PP</sub> differential clock amplitude, 50% clock duty cycle, -1dBFS differential analog input, DDR LVDS output interface, and 32k-point FFT, unless otherwise noted.

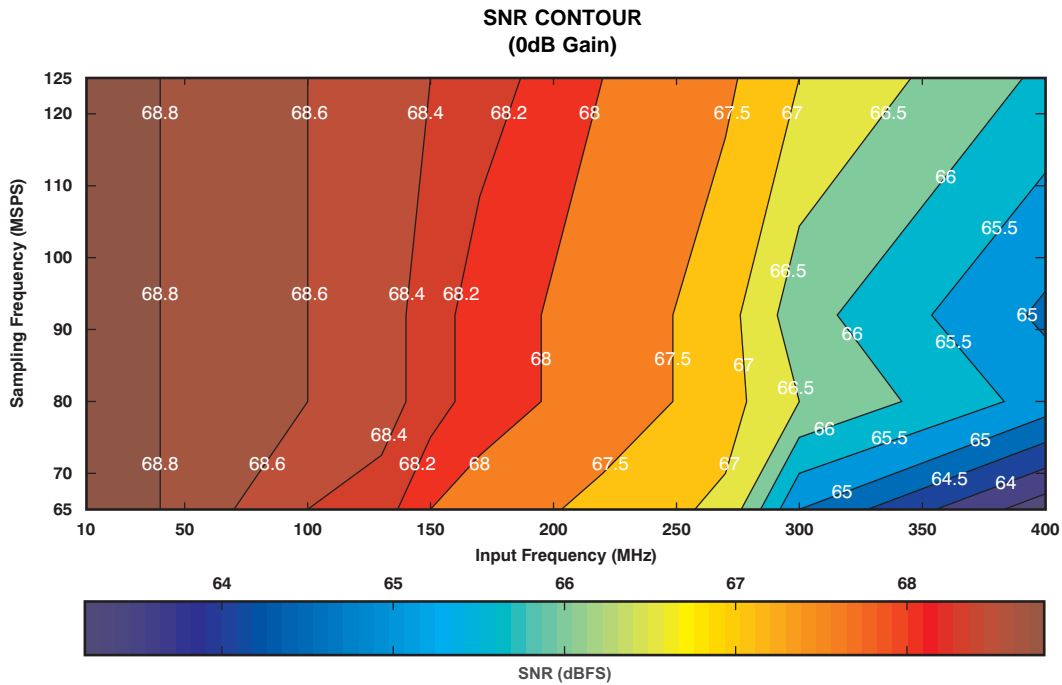

Figure 39.

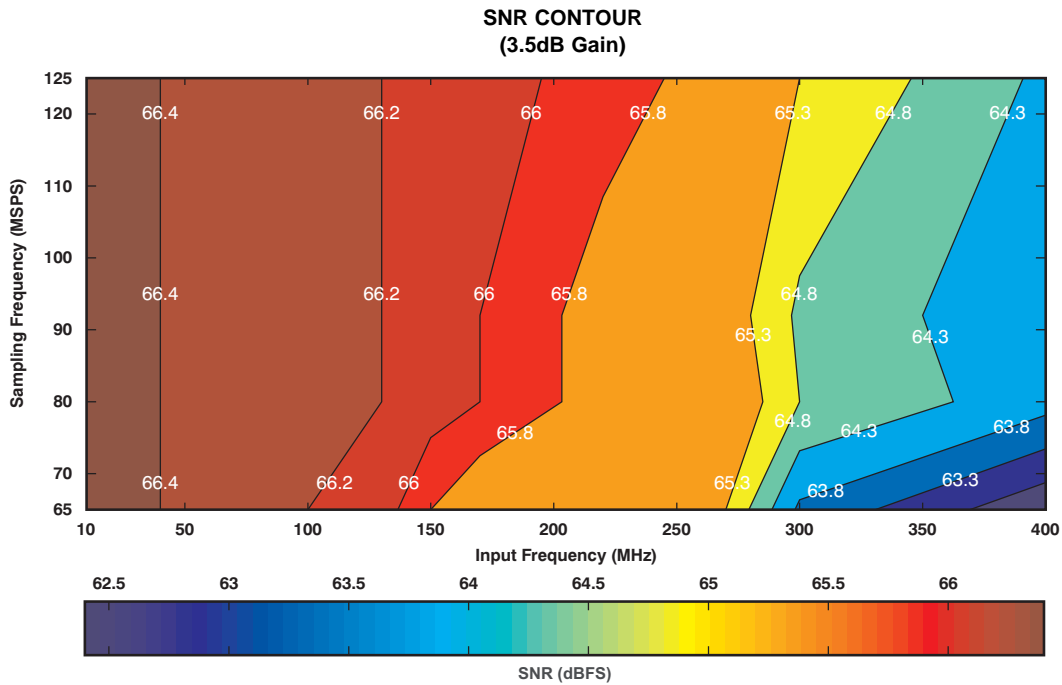

Figure 40.

## APPLICATION INFORMATION

### THEORY OF OPERATION

The ADS41B25 is a buffered analog input and ultralow power ADC with maximum sampling rates up to 125MSPS. The conversion process is initiated by a rising edge of the external input clock and the analog input signal is sampled. The sampled signal is sequentially converted by a series of small resolution stages, with the outputs combined in a digital correction logic block. At every clock edge the sample propagates through the pipeline, resulting in a data latency of 21 clock cycles. The output is available as 12-bit data, in DDR LVDS mode or CMOS mode, and coded in either straight offset binary or binary two's complement format.

### ANALOG INPUT

The analog input pins have analog buffers (powered from the AVDD\_BUF supply) that internally drive the differential sampling circuit. As a result of the analog buffer, the input pins present high input impedance to the external driving source (10kΩ dc resistance and 3.5pF input capacitance). The buffer helps to isolate the external driving source from the switching currents of the sampling circuit. This buffering makes it easy to drive the buffered inputs compared to an ADC without the buffer.

The input common-mode is set internally using a 5kΩ resistor from each input pin to 1.7V, so the input signal can be ac-coupled to the pins. Each input pin (INP, INM) must swing symmetrically between (VCM + 0.375V) and (VCM – 0.375V), resulting in a 1.5V<sub>PP</sub> differential input swing.

The input sampling circuit has a high 3dB bandwidth that extends up to 800MHz (measured from the input pins to the sampled voltage). [Figure 41](#) shows an equivalent circuit for the analog input.

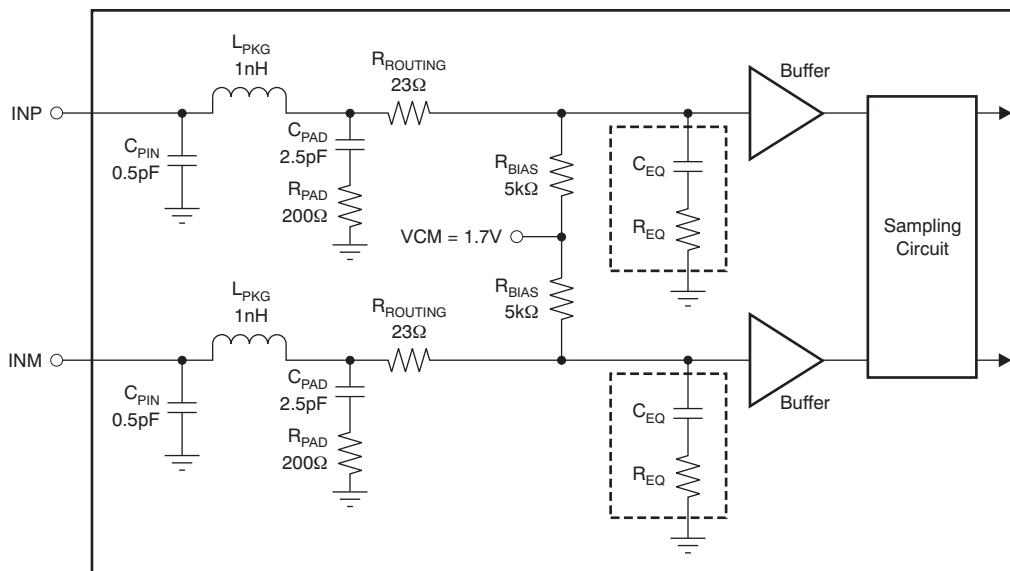

- (1)  $C_{EQ}$  refers to the equivalent input capacitance of the buffer = 4pF.
- (2)  $R_{EQ}$  refers to the  $R_{EQ}$  buffer = 10Ω.
- (3) This equivalent circuit is an approximation and valid for frequencies less than 700MHz.

**Figure 41. Analog Input Equivalent Circuit<sup>(3)</sup>**

### Drive Circuit Requirements

For optimum performance, the analog inputs must be driven differentially. This technique improves the common-mode noise immunity and even-order harmonic rejection. A small resistor (5Ω to 10Ω) in series with each input pin is recommended to damp out ringing caused by package parasitics.

Figure 42 and Figure 43 show the differential impedance ( $Z_{IN} = R_{IN} \parallel C_{IN}$ ) seen by looking into the ADC input pins. The presence of the analog input buffer produces an almost constant input capacitance, as shown in Figure 42.

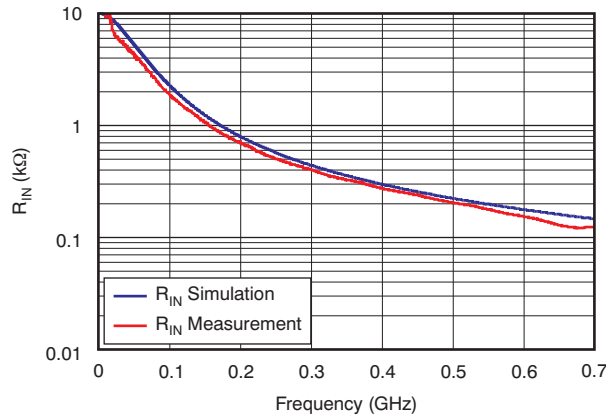

Figure 42. ADC Analog Input Resistance ( $R_{IN}$ ) Across Frequency

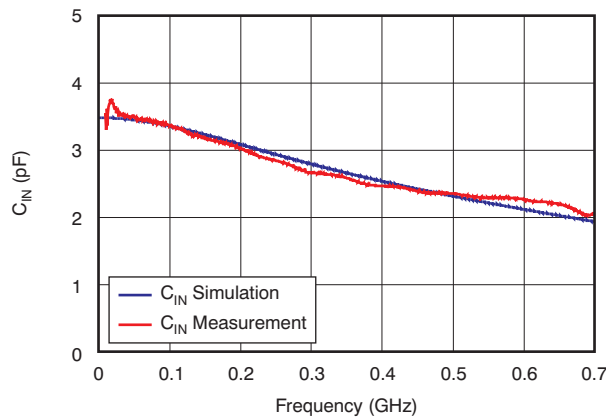
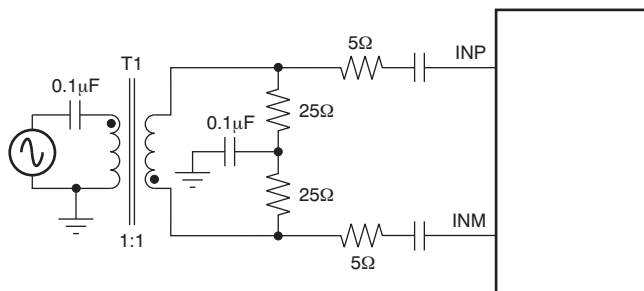

Figure 43. ADC Analog Input Capacitance ( $C_{IN}$ ) Across Frequency

## Driving Circuit

Two example driving circuit configurations are shown in [Figure 44](#) and [Figure 45](#)—one optimized for low input frequencies and the other optimized for high input frequencies.

In [Figure 44](#), a single transformer is used and is suited for low input frequencies. To optimize even-harmonic performance at high input frequencies (greater than the first Nyquist), the use of back-to-back transformers is recommended (see [Figure 45](#)). Note that both drive circuits have been terminated by  $50\Omega$  near the ADC side. The ac-coupling capacitors allow the analog inputs to self-bias around the required common-mode voltage.



**Figure 44. Drive Circuit for Low Input Frequencies**

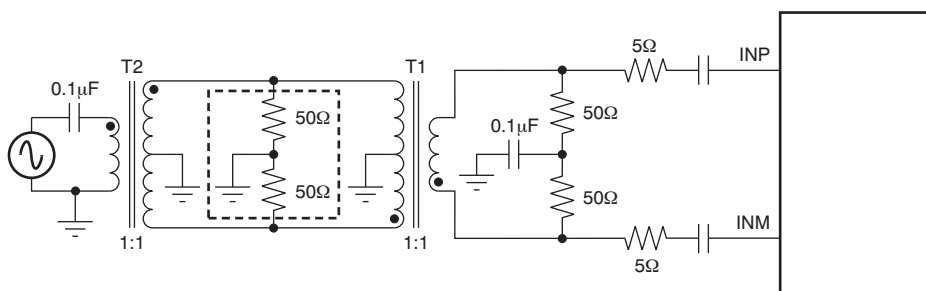
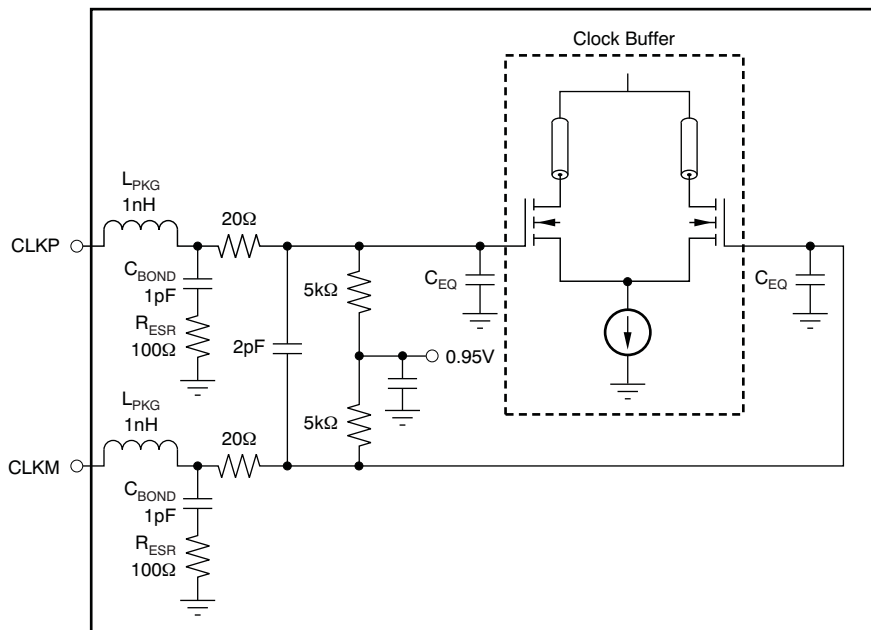

**Figure 45. Drive Circuit for High Input Frequencies**

The mismatch in the transformer parasitic capacitance (between the windings) results in degraded even-order harmonic performance. Connecting two identical RF transformers back-to-back helps minimize this mismatch and good performance is obtained for high-frequency input signals. An additional termination resistor pair may be required between the two transformers, as shown in [Figure 44](#) and [Figure 45](#). The center point of this termination is connected to ground to improve the balance between the P (positive) and M (negative) sides. The values of the terminations between the transformers and on the secondary side must be chosen to obtain an effective  $50\Omega$  (for a  $50\Omega$  source impedance).

### CLOCK INPUT

The ADS41B25 clock inputs can be driven differentially (sine, LVPECL, or LVDS) or single-ended (LVCMOS), with little or no difference in performance between them. The common-mode voltage of the clock inputs is set to VCM using internal 5kΩ resistors. This setting allows the use of transformer-coupled drive circuits for sine-wave clock or ac-coupling for LVPECL and LVDS clock sources. Figure 46 shows an equivalent circuit for the input clock.



NOTE: C<sub>EQ</sub> is 1pF to 3pF and is the equivalent input capacitance of the clock buffer.

**Figure 46. Input Clock Equivalent Circuit**

A single-ended CMOS clock can be ac-coupled to the CLKP input, with CLKM connected to ground with a 0.1μF capacitor, as shown in Figure 47. For best performance, the clock inputs must be driven differentially, reducing susceptibility to common-mode noise. For high input frequency sampling, it is recommended to use a clock source with very low jitter. Band-pass filtering of the clock source can help reduce the effects of jitter. There is no change in performance with a non-50% duty cycle clock input. Figure 48 shows a differential circuit.

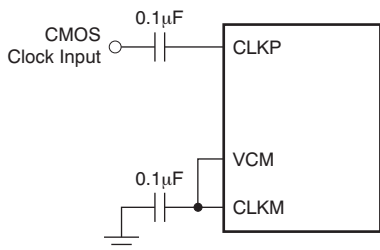

**Figure 47. Single-Ended Clock Driving Circuit**

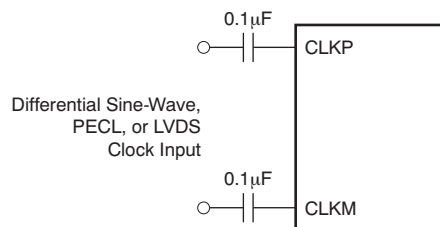

**Figure 48. Differential Clock Driving Circuit**



## GAIN FOR SFDR/SNR TRADE-OFF

The ADS41B25 includes gain settings that can be used to get improved SFDR performance. The gain is programmable from 0dB to 3.5dB (in 0.5dB steps) using the GAIN register bits. For each gain setting, the analog input full-scale range scales proportionally, as shown in [Table 7](#).

The SFDR improvement is achieved at the expense of SNR; for each gain setting, the SNR degrades approximately between 0.5dB and 1dB. The SNR degradation is reduced at high input frequencies. As a result, the gain is very useful at high input frequencies because the SFDR improvement is significant with marginal degradation in SNR. Therefore, the gain can be used to trade-off between SFDR and SNR.

After a reset, the gain is enabled with 0dB gain setting. For other gain settings, program the GAIN register bits.

**Table 7. Full-Scale Range Across Gains**

GAIN (dB)	TYPE	FULL-SCALE ( $V_{PP}$ )
0	Default after reset	1.5
0.5	Programmable gain	1.41
1	Programmable gain	1.33
1.5	Programmable gain	1.26
2	Programmable gain	1.19
2.5	Programmable gain	1.12
3	Programmable gain	1.06
3.5	Programmable gain	1

## OFFSET CORRECTION

The ADS41B25 has an internal offset correction algorithm that estimates and corrects dc offset up to  $\pm 10\text{mV}$ . The correction can be enabled using the EN OFFSET CORR serial register bit. Once enabled, the algorithm estimates the channel offset and applies the correction every clock cycle. The time constant of the correction loop is a function of the sampling clock frequency. The time constant can be controlled using the OFFSET CORR TIME CONSTANT register bits, as described in [Table 8](#).

**Table 8. Time Constant of Offset Correction Loop**

OFFSET CORR TIME CONSTANT	TIME CONSTANT, $T_{C_{CLK}}$ (Number of Clock Cycles)	TIME CONSTANT, $T_{C_{CLK}} \times 1/f_S$ (sec) <sup>(1)</sup>
0000	1M	8ms
0001	2M	16ms
0010	4M	33.5ms
0011	8M	67ms
0100	16M	134ms
0101	32M	268ms
0110	64M	537ms
0111	128M	1.1s
1000	256M	2.2s
1001	512M	4.3s
1010	1G	8.6s
1011	2G	17s
1100	Reserved	—
1101	Reserved	—
1110	Reserved	—
1111	Reserved	—

(1) Sampling frequency,  $f_S = 125\text{MSPS}$ .

After the offset is estimated, the correction can be frozen by setting `FREEZE OFFSET CORR = 1`. Once frozen, the last estimated value is used for the offset correction of every clock cycle. Note that offset correction is disabled by a default after reset.

After a reset, the offset correction is disabled. To use offset correction set `EN OFFSET CORR` to '1' and program the required time constant. Figure 49 shows the time response of the offset correction algorithm after it is enabled.

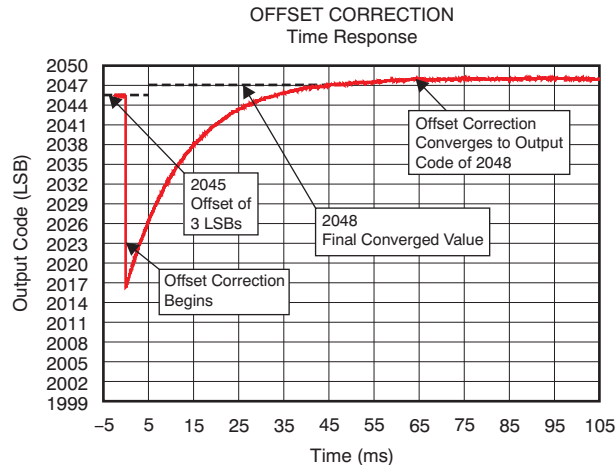

**Figure 49. Time Response of Offset Correction**

## POWER DOWN

The ADS41B25 has three power-down modes: power-down global, standby, and output buffer disable.

### Power-Down Global

In this mode, the entire chip (including the ADC, internal reference, and the output buffers) is powered down, resulting in reduced total power dissipation of about 7mW. The output buffers are in a high-impedance state. The wake-up time from the global power-down to data becoming valid in normal mode is typically 100µs. To enter the global power-down mode, set the `PDN GLOBAL` register bit.

### Standby

In this mode, only the ADC is powered down and the internal references are active, resulting in a fast wake-up time of 5µs. The total power dissipation in standby mode is approximately 145mW. To enter the standby mode, set the `STBY` register bit.

### Output Buffer Disable

The output buffers can be disabled and put in a high-impedance state; wakeup time from this mode is fast, approximately 100ns. This can be controlled using the `PDN OBUF` register bit or using the `OE` pin.

### Input Clock Stop

In addition, the converter enters a low-power mode when the input clock frequency falls below 1MSPS. The power dissipation is approximately 92mW.

## POWER-SUPPLY SEQUENCE

During power-up, the `AVDD`, `AVDD_BUF`, and `DRVDD` supplies can come up in any sequence. These supplies are separated in the device. Externally, they can be driven from separate supplies or from a single supply.

## DIGITAL OUTPUT INFORMATION

The ADS41B25 provides 12-bit data and an output clock synchronized with the data.

### Output Interface

Two output interface options are available: double data rate (DDR) LVDS and parallel CMOS. They can be selected using the LVDS CMOS serial interface register bit or using the DFS pin.

### DDR LVDS Outputs

In this mode, the data bits and clock are output using low voltage differential signal (LVDS) levels. Two data bits are multiplexed and output on each LVDS differential pair, as shown in [Figure 50](#).

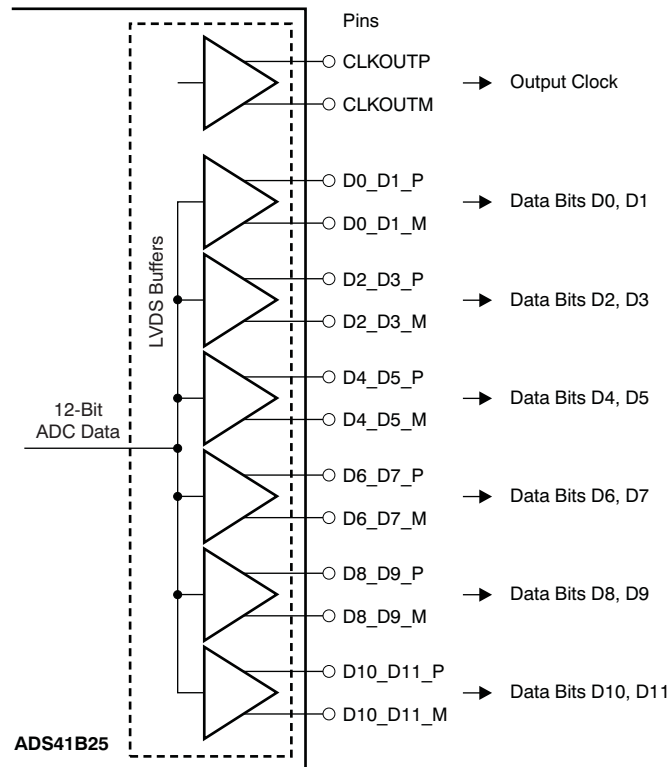
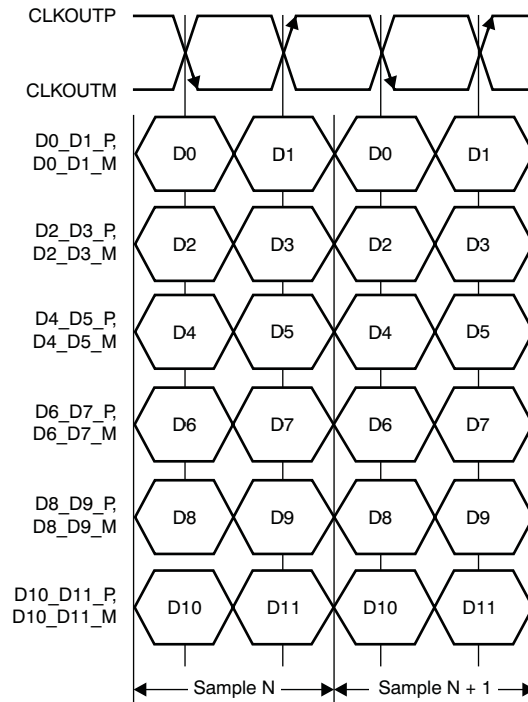

Figure 50. ADS41B25 LVDS Data Outputs

Even data bits (D0, D2, D4, etc.) are output at the falling edge of CLKOUTP and the odd data bits (D1, D3, D5, etc.) are output at the rising edge of CLKOUTP. Both the rising and falling edges of CLKOUTP must be used to capture all 12 data bits, as shown in Figure 51.



**Figure 51. DDR LVDS Interface**

## LVDS Output Data and Clock Buffers

The equivalent circuit of each LVDS output buffer is shown in [Figure 52](#). After reset, the buffer presents an output impedance of 100Ω to match with the external 100Ω termination.

The  $V_{DIFF}$  voltage is nominally 350mV, resulting in an output swing of  $\pm 350$ mV with 100Ω external termination. The  $V_{DIFF}$  voltage is programmable using the LVDS SWING register bits from  $\pm 125$ mV to  $\pm 570$ mV.

Additionally, a mode exists to double the strength of the LVDS buffer to support 50Ω differential termination. This mode can be used when the output LVDS signal is routed to two separate receiver chips, each using a 100Ω termination. The mode can be enabled using the LVDS DATA STRENGTH and LVDS CLKOUT STRENGTH register bits for data and output clock buffers, respectively.

The buffer output impedance behaves in the same way as a source-side series termination. By absorbing reflections from the receiver end, it helps to improve signal integrity.

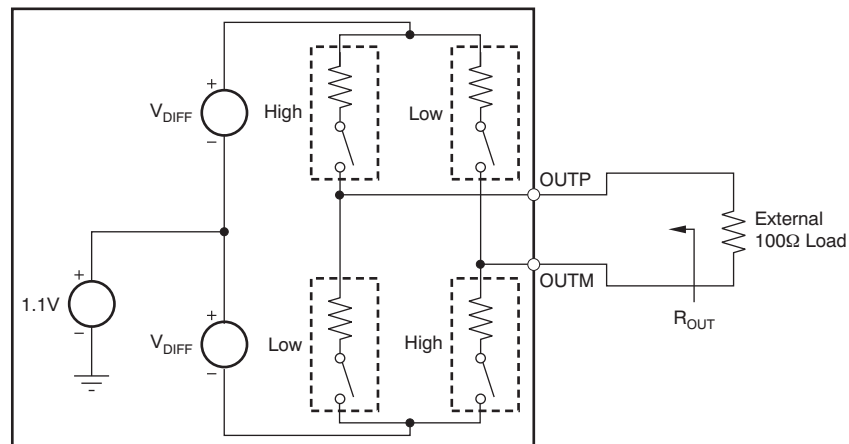

NOTE: Use the default buffer strength to match 100Ω external termination ( $R_{OUT} = 100\Omega$ ). To match with a 50Ω external termination, set the LVDS STRENGTH bit ( $R_{OUT} = 50\Omega$ ).

**Figure 52. LVDS Buffer Equivalent Circuit**

## Parallel CMOS Interface

In CMOS mode, each data bit is output on a separate pin as the CMOS voltage level, for every clock cycle. The rising edge of the output clock CLKOUT can be used to latch data in the receiver. [Figure 53](#) depicts the CMOS output interface.

Switching noise (caused by CMOS output data transitions) can couple into the analog inputs and degrade SNR. The coupling and SNR degradation increases as the output buffer drive is made stronger. To minimize this degradation, the CMOS output buffers are designed with controlled drive strength. The default drive strength ensures a wide data stable window (even at 125MSPS) is provided so the data outputs have minimal load capacitance. It is recommended to use short traces (one to two inches or 2,54cm to 5,08cm) terminated with less than 5pF load capacitance, as shown in [Figure 54](#).

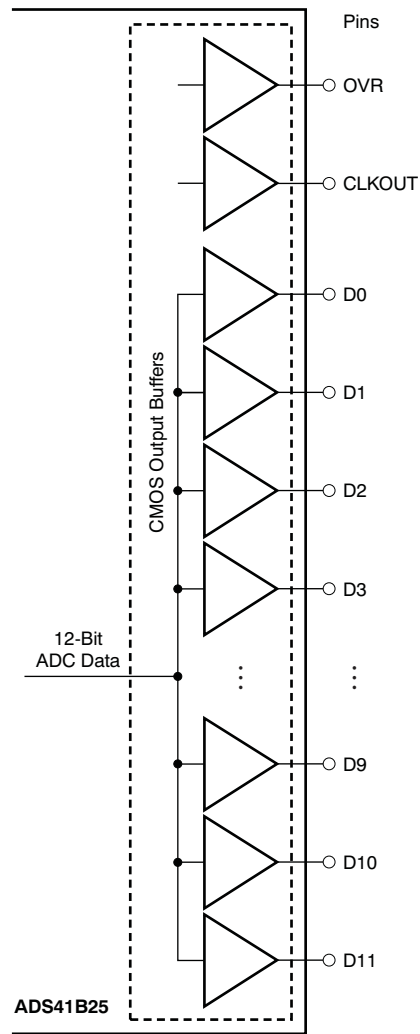

**Figure 53. CMOS Output Interface**

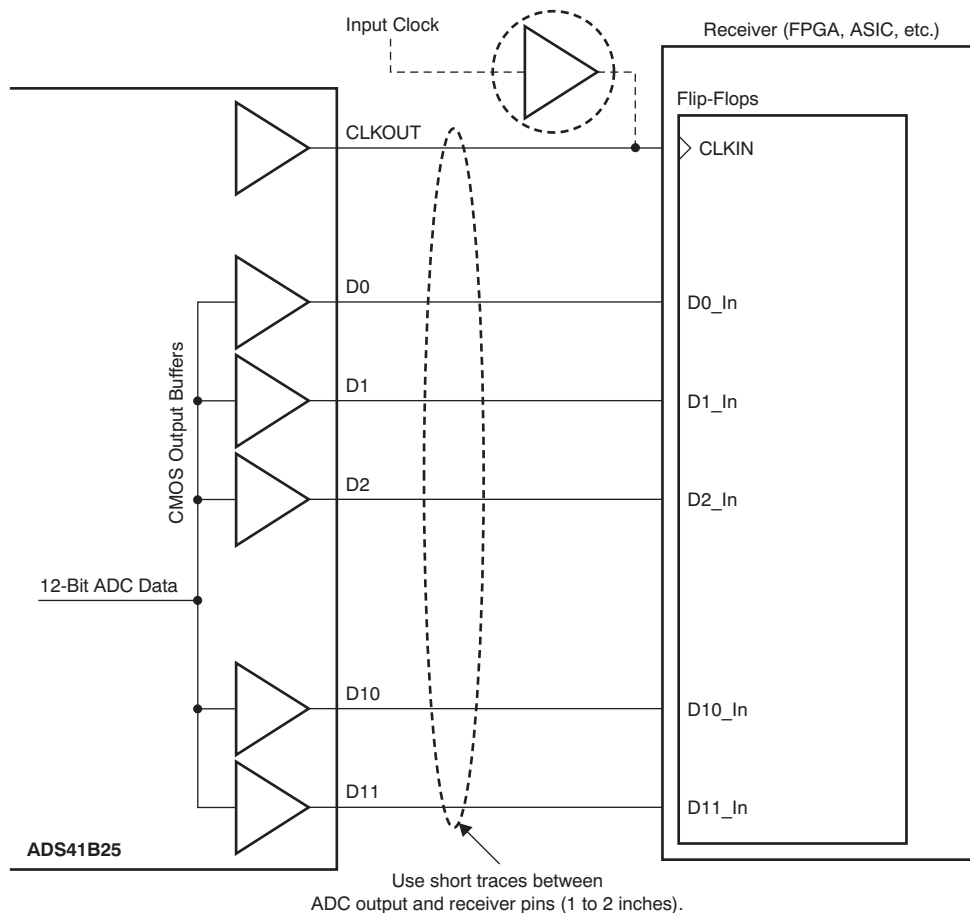

**Figure 54. Using the CMOS Data Outputs**

### CMOS Interface Power Dissipation

With CMOS outputs, the DRVDD current scales with the sampling frequency and the load capacitance on every output pin. The maximum DRVDD current occurs when each output bit toggles between '0' and '1' every clock cycle. In actual applications, this condition is unlikely to occur. The actual DRVDD current would be determined by the average number of output bits switching, which is a function of the sampling frequency and the nature of the analog input signal.

Digital Current as a Result of CMOS Output Switching =  $C_L \times \text{DRVDD} \times (N \times f_{\text{AVG}})$

where:

$C_L$  = load capacitance,

$N \times f_{\text{AVG}}$  = average number of output bits switching.

(1)

Figure 36 illustrates the current across sampling frequencies at 2MHz analog input frequency.

### Input Over-Voltage Indication (OVR Pin)

The device has an OVR pin that provides information about analog input overload. At any clock cycle, if the sampled input voltage exceeds the positive or negative full-scale range, the OVR pin goes high. The OVR remains high as long as the overload condition persists. The OVR pin is a CMOS output buffer (running off DRVDD supply), independent of the type of output data interface (DDR LVDS or CMOS).

For a positive overload, the D[11:0] output data bits are FFFh in offset binary output format and 7FFh in twos complement output format. For a negative input overload, the output code is 000h in offset binary output format and 800h in twos complement output format.

### Output Data Format

Two output data formats are supported: twos complement and offset binary. They can be selected using the DATA FORMAT serial interface register bit or controlling the DFS pin in parallel configuration mode. In the event of an input voltage overdrive, the digital outputs go to the appropriate full-scale level.

## BOARD DESIGN CONSIDERATIONS

### Grounding

A single ground plane is sufficient to give good performance, provided the analog, digital, and clock sections of the board are cleanly partitioned. See the *ADS414x, ADS412x EVM User Guide (SLWU067)* for details on layout and grounding.

### Supply Decoupling

Because the ADS41B25 already includes internal decoupling, minimal external decoupling can be used without loss in performance. Note that decoupling capacitors can help filter external power-supply noise, so the optimum number of capacitors depends on the actual application. The decoupling capacitors should be placed very close to the converter supply pins.

### Exposed Pad

In addition to providing a path for heat dissipation, the PowerPAD is also electrically internally connected to the digital ground. Therefore, it is necessary to solder the exposed pad to the ground plane for best thermal and electrical performance. For detailed information, see application notes *QFN Layout Guidelines (SLOA122)* and *QFN/SON PCB Attachment (SLUA271)*, both available for download at the TI web site ([www.ti.com](http://www.ti.com)).



## DEFINITION OF SPECIFICATIONS

**Analog Bandwidth** – The analog input frequency at which the power of the fundamental is reduced by 3 dB with respect to the low-frequency value.

**Aperture Delay** – The delay in time between the rising edge of the input sampling clock and the actual time at which the sampling occurs. This delay is different across channels. The maximum variation is specified as aperture delay variation (channel-to-channel).

**Aperture Uncertainty (Jitter)** – The sample-to-sample variation in aperture delay.

**Clock Pulse Width/Duty Cycle** – The duty cycle of a clock signal is the ratio of the time the clock signal remains at a logic high (clock pulse width) to the period of the clock signal. Duty cycle is typically expressed as a percentage. A perfect differential sine-wave clock results in a 50% duty cycle.

**Maximum Conversion Rate** – The maximum sampling rate at which specified operation is given. All parametric testing is performed at this sampling rate unless otherwise noted.

**Minimum Conversion Rate** – The minimum sampling rate at which the ADC functions.

**Differential Nonlinearity (DNL)** – An ideal ADC exhibits code transitions at analog input values spaced exactly 1 LSB apart. The DNL is the deviation of any single step from this ideal value, measured in units of LSBs.

**Integral Nonlinearity (INL)** – The INL is the deviation of the ADC transfer function from a best fit line determined by a least squares curve fit of that transfer function, measured in units of LSBs.

**Gain Error** – Gain error is the deviation of the ADC actual input full-scale range from its ideal value. The gain error is given as a percentage of the ideal input full-scale range. Gain error has two components: error as a result of reference inaccuracy and error as a result of the channel. Both errors are specified independently as  $E_{GREF}$  and  $E_{GCHAN}$ .

To a first-order approximation, the total gain error is  $E_{TOTAL} \sim E_{GREF} + E_{GCHAN}$ .

For example, if  $E_{TOTAL} = \pm 0.5\%$ , the full-scale input varies from  $(1 - 0.5/100) \times FS_{ideal}$  to  $(1 + 0.5/100) \times FS_{ideal}$ .

**Offset Error** – The offset error is the difference, given in number of LSBs, between the ADC actual average idle channel output code and the ideal average idle channel output code. This quantity is often mapped into millivolts.

**Temperature Drift** – The temperature drift coefficient (with respect to gain error and offset error) specifies the change per degree Celsius of the parameter from  $T_{MIN}$  to  $T_{MAX}$ . It is calculated by dividing the maximum deviation of the parameter across the  $T_{MIN}$  to  $T_{MAX}$  range by the difference  $T_{MAX} - T_{MIN}$ .

**Signal-to-Noise Ratio** – SNR is the ratio of the power of the fundamental ( $P_S$ ) to the noise floor power ( $P_N$ ), excluding the power at dc and the first nine harmonics.

$$SNR = 10 \log_{10} \frac{P_S}{P_N} \quad (2)$$

SNR is either given in units of dBc (dB to carrier) when the absolute power of the fundamental is used as the reference, or dBFS (dB to full-scale) when the power of the fundamental is extrapolated to the converter full-scale range.

**Signal-to-Noise and Distortion (SINAD)** – SINAD is the ratio of the power of the fundamental ( $P_S$ ) to the power of all the other spectral components including noise ( $P_N$ ) and distortion ( $P_D$ ), but excluding dc.

$$SINAD = 10 \log_{10} \frac{P_S}{P_N + P_D} \quad (3)$$

SINAD is either given in units of dBc (dB to carrier) when the absolute power of the fundamental is used as the reference, or dBFS (dB to full-scale) when the power of the fundamental is extrapolated to the converter full-scale range.

**Effective Number of Bits (ENOB)** – ENOB is a measure of the converter performance as compared to the theoretical limit based on quantization noise.

$$\text{ENOB} = \frac{\text{SINAD} - 1.76}{6.02} \quad (4)$$

**Total Harmonic Distortion (THD)** – THD is the ratio of the power of the fundamental ( $P_S$ ) to the power of the first nine harmonics ( $P_D$ ).

$$\text{THD} = 10 \log^{10} \frac{P_S}{P_N} \quad (5)$$

THD is typically given in units of dBc (dB to carrier).

**Spurious-Free Dynamic Range (SFDR)** – The ratio of the power of the fundamental to the highest other spectral component (either spur or harmonic). SFDR is typically given in units of dBc (dB to carrier).

**Two-Tone Intermodulation Distortion** – IMD3 is the ratio of the power of the fundamental (at frequencies  $f_1$  and  $f_2$ ) to the power of the worst spectral component at either frequency  $2f_1 - f_2$  or  $2f_2 - f_1$ . IMD3 is either given in units of dBc (dB to carrier) when the absolute power of the fundamental is used as the reference, or dBFS (dB to full-scale) when the power of the fundamental is extrapolated to the converter full-scale range.

**DC Power-Supply Rejection Ratio (DC PSRR)** – DC PSRR is the ratio of the change in offset error to a change in analog supply voltage. The dc PSRR is typically given in units of mV/V.

**AC Power-Supply Rejection Ratio (AC PSRR)** – AC PSRR is the measure of rejection of variations in the supply voltage by the ADC. If  $\Delta V_{\text{SUP}}$  is the change in supply voltage and  $\Delta V_{\text{OUT}}$  is the resultant change of the ADC output code (referred to the input), then:

$$\text{PSRR} = 20 \log^{10} \frac{\Delta V_{\text{OUT}}}{\Delta V_{\text{SUP}}} \quad (\text{Expressed in dBc}) \quad (6)$$

**Voltage Overload Recovery** – The number of clock cycles taken to recover to less than 1% error after an overload on the analog inputs. This is tested by separately applying a sine wave signal with 6dB positive and negative overload. The deviation of the first few samples after the overload (from the expected values) is noted.

**Common-Mode Rejection Ratio (CMRR)** – CMRR is the measure of rejection of variation in the analog input common-mode by the ADC. If  $\Delta V_{\text{CM\_IN}}$  is the change in the common-mode voltage of the input pins and  $\Delta V_{\text{OUT}}$  is the resulting change of the ADC output code (referred to the input), then:

$$\text{CMRR} = 20 \log^{10} \frac{\Delta V_{\text{OUT}}}{\Delta V_{\text{CM}}} \quad (\text{Expressed in dBc}) \quad (7)$$

**Crosstalk (only for multi-channel ADCs)** – This is a measure of the internal coupling of a signal from an adjacent channel into the channel of interest. It is specified separately for coupling from the immediate neighboring channel (near-channel) and for coupling from channel across the package (far-channel). It is usually measured by applying a full-scale signal in the adjacent channel. Crosstalk is the ratio of the power of the coupling signal (as measured at the output of the channel of interest) to the power of the signal applied at the adjacent channel input. It is typically expressed in dBc.

**PACKAGING INFORMATION**

Orderable Device	Status (1)	Package Type	Package Drawing	Pins	Package Qty	Eco Plan (2)	Lead/Ball Finish (6)	MSL Peak Temp (3)	Op Temp (°C)	Device Marking (4/5)	Samples
ADS41B25IRGZR	ACTIVE	VQFN	RGZ	48	2500	Green (RoHS & no Sb/Br)	NIPDAU	Level-3-260C-168 HR	-40 to 85	AZ41B25	<a href="#">Samples</a>
ADS41B25IRGZT	ACTIVE	VQFN	RGZ	48	250	Green (RoHS & no Sb/Br)	NIPDAU	Level-3-260C-168 HR	-40 to 85	AZ41B25	<a href="#">Samples</a>

(1) The marketing status values are defined as follows:

**ACTIVE:** Product device recommended for new designs.

**LIFEBUY:** TI has announced that the device will be discontinued, and a lifetime-buy period is in effect.

**NRND:** Not recommended for new designs. Device is in production to support existing customers, but TI does not recommend using this part in a new design.

**PREVIEW:** Device has been announced but is not in production. Samples may or may not be available.

**OBSOLETE:** TI has discontinued the production of the device.

(2) **RoHS:** TI defines "RoHS" to mean semiconductor products that are compliant with the current EU RoHS requirements for all 10 RoHS substances, including the requirement that RoHS substance do not exceed 0.1% by weight in homogeneous materials. Where designed to be soldered at high temperatures, "RoHS" products are suitable for use in specified lead-free processes. TI may reference these types of products as "Pb-Free".

**RoHS Exempt:** TI defines "RoHS Exempt" to mean products that contain lead but are compliant with EU RoHS pursuant to a specific EU RoHS exemption.

**Green:** TI defines "Green" to mean the content of Chlorine (Cl) and Bromine (Br) based flame retardants meet JS709B low halogen requirements of <=1000ppm threshold. Antimony trioxide based flame retardants must also meet the <=1000ppm threshold requirement.

(3) MSL, Peak Temp. - The Moisture Sensitivity Level rating according to the JEDEC industry standard classifications, and peak solder temperature.

(4) There may be additional marking, which relates to the logo, the lot trace code information, or the environmental category on the device.

(5) Multiple Device Markings will be inside parentheses. Only one Device Marking contained in parentheses and separated by a "~" will appear on a device. If a line is indented then it is a continuation of the previous line and the two combined represent the entire Device Marking for that device.

(6) Lead/Ball Finish - Orderable Devices may have multiple material finish options. Finish options are separated by a vertical ruled line. Lead/Ball Finish values may wrap to two lines if the finish value exceeds the maximum column width.

**Important Information and Disclaimer:**The information provided on this page represents TI's knowledge and belief as of the date that it is provided. TI bases its knowledge and belief on information provided by third parties, and makes no representation or warranty as to the accuracy of such information. Efforts are underway to better integrate information from third parties. TI has taken and continues to take reasonable steps to provide representative and accurate information but may not have conducted destructive testing or chemical analysis on incoming materials and chemicals. TI and TI suppliers consider certain information to be proprietary, and thus CAS numbers and other limited information may not be available for release.

In no event shall TI's liability arising out of such information exceed the total purchase price of the TI part(s) at issue in this document sold by TI to Customer on an annual basis.



## TAPE AND REEL INFORMATION



### QUADRANT ASSIGNMENTS FOR PIN 1 ORIENTATION IN TAPE



\*All dimensions are nominal

Device	Package Type	Package Drawing	Pins	SPQ	Reel Diameter (mm)	Reel Width W1 (mm)	A0 (mm)	B0 (mm)	K0 (mm)	P1 (mm)	W (mm)	Pin1 Quadrant
ADS41B25IRGZR	VQFN	RGZ	48	2500	330.0	16.4	7.3	7.3	1.5	12.0	16.0	Q2
ADS41B25IRGZT	VQFN	RGZ	48	250	180.0	16.4	7.3	7.3	1.5	12.0	16.0	Q2

**TAPE AND REEL BOX DIMENSIONS**

\*All dimensions are nominal

Device	Package Type	Package Drawing	Pins	SPQ	Length (mm)	Width (mm)	Height (mm)
ADS41B25IRGZR	VQFN	RGZ	48	2500	350.0	350.0	43.0
ADS41B25IRGZT	VQFN	RGZ	48	250	213.0	191.0	55.0

## GENERIC PACKAGE VIEW

**RGZ 48**

**VQFN - 1 mm max height**

7 x 7, 0.5 mm pitch

PLASTIC QUADFLAT PACK- NO LEAD



Images above are just a representation of the package family, actual package may vary.  
Refer to the product data sheet for package details.

4224671/A

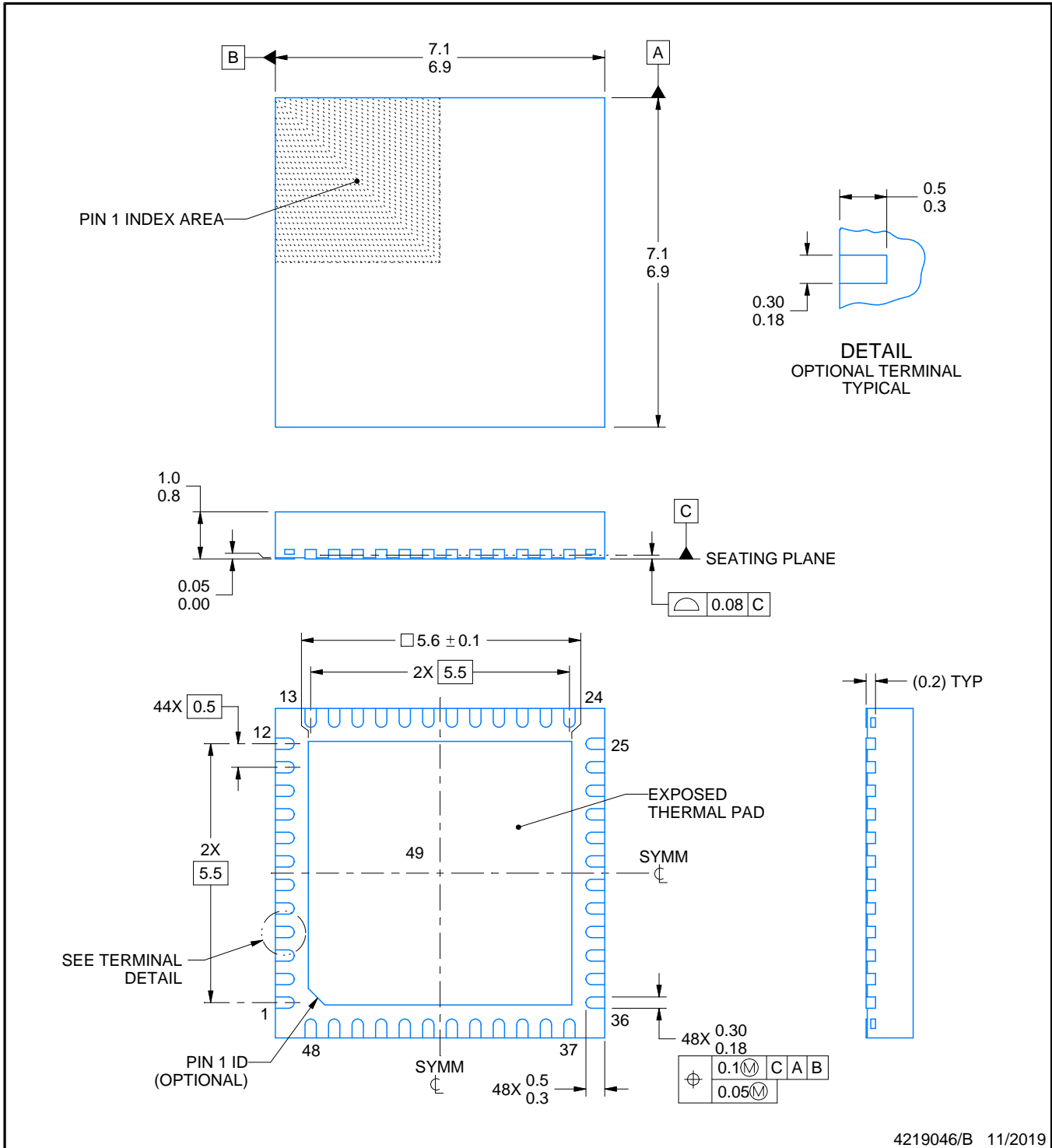

4219046/B 11/2019

NOTES:

1. All linear dimensions are in millimeters. Any dimensions in parenthesis are for reference only. Dimensioning and tolerancing per ASME Y14.5M.
2. This drawing is subject to change without notice.
3. The package thermal pad must be soldered to the printed circuit board for thermal and mechanical performance.



# EXAMPLE BOARD LAYOUT

RGZ0048D

VQFN - 1 mm max height

PLASTIC QUAD FLATPACK - NO LEAD



LAND PATTERN EXAMPLE  
EXPOSED METAL SHOWN  
SCALE:12X

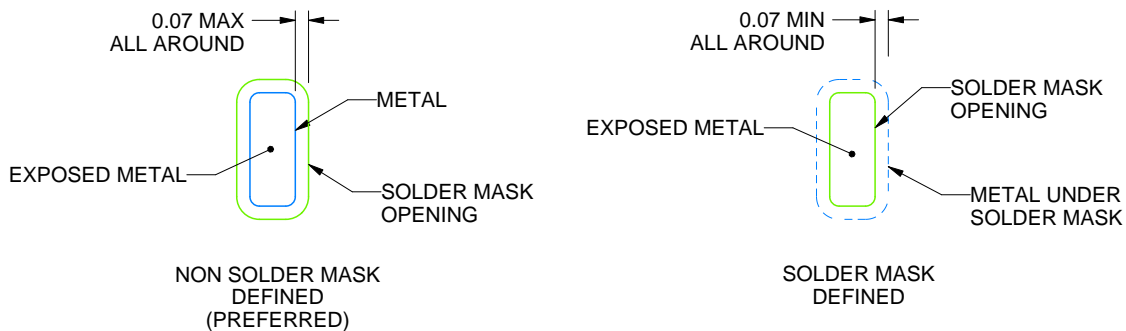

SOLDER MASK DETAILS

4219046/B 11/2019

NOTES: (continued)

- This package is designed to be soldered to a thermal pad on the board. For more information, see Texas Instruments literature number SLUA271 ([www.ti.com/lit/slua271](http://www.ti.com/lit/slua271)).
- Vias are optional depending on application, refer to device data sheet. If any vias are implemented, refer to their locations shown on this view. It is recommended that vias under paste be filled, plugged or tented.

# EXAMPLE STENCIL DESIGN

RGZ0048D

VQFN - 1 mm max height

PLASTIC QUAD FLATPACK - NO LEAD

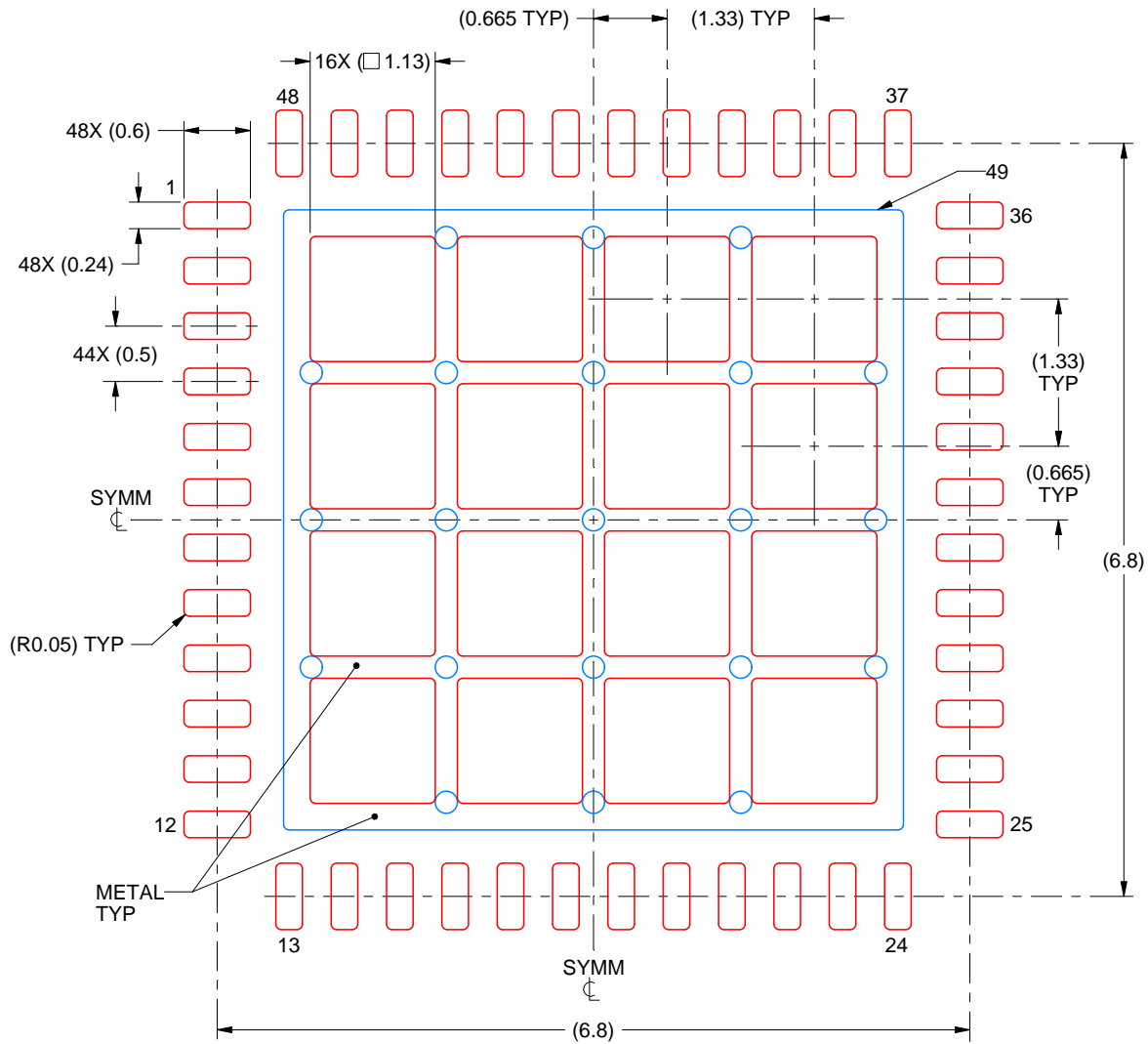

**SOLDER PASTE EXAMPLE**  
 BASED ON 0.125 mm THICK STENCIL

EXPOSED PAD 49  
 66% PRINTED SOLDER COVERAGE BY AREA UNDER PACKAGE  
 SCALE:15X

4219046/B 11/2019

NOTES: (continued)

6. Laser cutting apertures with trapezoidal walls and rounded corners may offer better paste release. IPC-7525 may have alternate design recommendations.

## IMPORTANT NOTICE AND DISCLAIMER

TI PROVIDES TECHNICAL AND RELIABILITY DATA (INCLUDING DATASHEETS), DESIGN RESOURCES (INCLUDING REFERENCE DESIGNS), APPLICATION OR OTHER DESIGN ADVICE, WEB TOOLS, SAFETY INFORMATION, AND OTHER RESOURCES "AS IS" AND WITH ALL FAULTS, AND DISCLAIMS ALL WARRANTIES, EXPRESS AND IMPLIED, INCLUDING WITHOUT LIMITATION ANY IMPLIED WARRANTIES OF MERCHANTABILITY, FITNESS FOR A PARTICULAR PURPOSE OR NON-INFRINGEMENT OF THIRD PARTY INTELLECTUAL PROPERTY RIGHTS.

These resources are intended for skilled developers designing with TI products. You are solely responsible for (1) selecting the appropriate TI products for your application, (2) designing, validating and testing your application, and (3) ensuring your application meets applicable standards, and any other safety, security, or other requirements. These resources are subject to change without notice. TI grants you permission to use these resources only for development of an application that uses the TI products described in the resource. Other reproduction and display of these resources is prohibited. No license is granted to any other TI intellectual property right or to any third party intellectual property right. TI disclaims responsibility for, and you will fully indemnify TI and its representatives against, any claims, damages, costs, losses, and liabilities arising out of your use of these resources.

TI's products are provided subject to TI's Terms of Sale ([www.ti.com/legal/termsofsale.html](http://www.ti.com/legal/termsofsale.html)) or other applicable terms available either on [ti.com](http://ti.com) or provided in conjunction with such TI products. TI's provision of these resources does not expand or otherwise alter TI's applicable warranties or warranty disclaimers for TI products.

Mailing Address: Texas Instruments, Post Office Box 655303, Dallas, Texas 75265  
Copyright © 2020, Texas Instruments Incorporated