



TigerSHARC® Embedded Processor

Preliminary Technical Data

ADSP-TS202S

KEY FEATURES

- 500 MHz, 2.0 ns Instruction Cycle Rate
- 12M Bits of Internal—On-Chip—DRAM Memory
- 25x25 mm (576-Ball) Thermally Enhanced Ball Grid Array Package
- Dual Computation Blocks—Each Containing an ALU, a Multiplier, a Shifter, and a Register File
- Dual Integer ALUs, providing Data Addressing and Pointer Manipulation
- Integrated I/O Includes 14 Channel DMA Controller, External Port, Four Link Ports, SDRAM Controller, Programmable Flag Pins, Two Timers, and Timer Expired Pin for System Integration
- 1149.1 IEEE Compliant JTAG Test Access Port for On-Chip Emulation
- On-Chip Arbitration for Glueless Multiprocessing

KEY BENEFITS

- Provides High-Performance Static Superscalar DSP Operations, Optimized for Large, Demanding Multiprocessor DSP Applications
- Performs Exceptionally Well on DSP Algorithm and I/O Benchmarks (See Benchmarks in [Table 1](#))
- Supports Low-Overhead DMA Transfers Between Internal Memory, External Memory, Memory-Mapped Peripherals, Link Ports, Host Processors, and Other (Multiprocessor) DSPs
- Eases DSP Programming Through Extremely Flexible Instruction Set and High-Level-Language Friendly DSP Architecture
- Enables Scalable Multiprocessing Systems With Low Communications Overhead

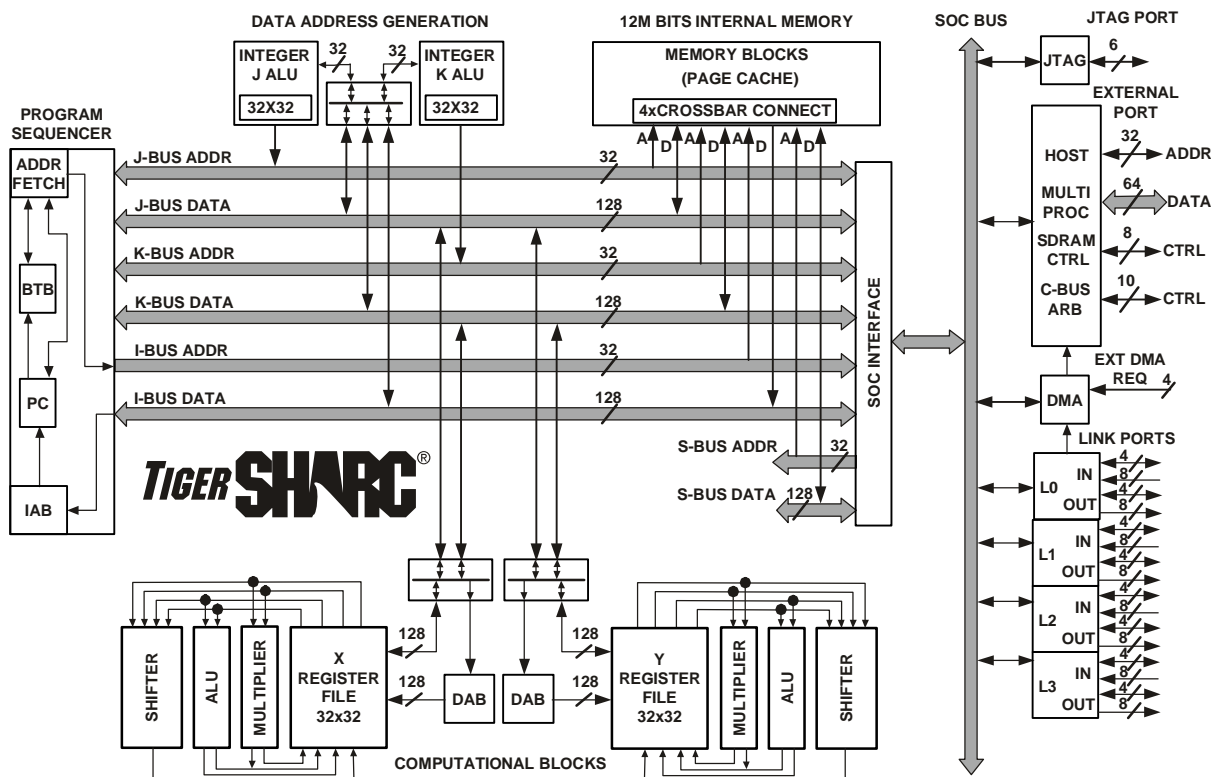

Figure 1. Functional block diagram

TigerSHARC and the TigerSHARC logo are registered trademarks of Analog Devices, Inc.

Rev. PrB

Information furnished by Analog Devices is believed to be accurate and reliable. However, no responsibility is assumed by Analog Devices for its use, nor for any infringements of patents or other rights of third parties that may result from its use. Specifications subject to change without notice. No license is granted by implication or otherwise under any patent or patent rights of Analog Devices. Trademarks and registered trademarks are the property of their respective owners.

One Technology Way, P.O. Box 9106, Norwood, MA 02062-9106 U.S.A.
Tel: 781/329-4700 www.analog.com
Fax: 781/326-8703 © 2003 Analog Devices, Inc. All rights reserved.

TABLE OF CONTENTS

| | | | |
|---------------------------------------------------------|----|---------------------------------------------------|----|
| General Description | 3 | Pin Function Descriptions | 12 |
| Dual Compute Blocks | 4 | Strap Pin Function Descriptions | 19 |
| Data Alignment Buffer (DAB) | 4 | ADSP-TS202S—Specifications | 21 |
| Dual Integer ALU (IALU) | 4 | Recommended Operating Conditions | 21 |
| Program Sequencer | 5 | Electrical Characteristics | 21 |
| Interrupt Controller | 5 | Absolute Maximum Ratings | 22 |
| Flexible Instruction Set | 5 | ESD Sensitivity | 22 |
| DSP Memory | 5 | Timing Specifications | 23 |
| External Port (Off-Chip Memory/Peripherals Interface) . | 5 | General AC Timing | 23 |
| Host Interface | 6 | Link Port Low-Voltage, Differential-Signal (LVDS) | |
| Multiprocessor Interface | 7 | Electrical Characteristics and Timing | 27 |
| SDRAM Controller | 7 | Link Port—Data Out Timing | 28 |
| EPROM Interface | 7 | Link Port—Data In Timing | 31 |
| DMA Controller | 7 | Output Drive Currents | 32 |
| Link Ports (LVDS) | 8 | Test Conditions | 33 |
| Timer and General-Purpose I/O | 9 | Output Disable Time | 33 |
| Reset and Booting | 9 | Output Enable Time | 34 |
| Clock Domains | 9 | Capacitive Loading | 34 |
| Power Domains | 9 | Environmental Conditions | 36 |
| Filtering Reference Voltage and Clocks | 9 | Thermal Characteristics | 36 |
| Development Tools | 10 | 576-Ball BGA_ED Pin Configurations | 36 |
| Designing an Emulator-Compatible DSP Board (Target) 11 | | Outline Dimensions | 40 |
| Additional Information | 11 | Ordering Guide | 40 |

REVISION HISTORY

Revision PrB:

- Applies corrections and additional information to VREF Filtering Scheme (page 9), SCLK_VREF filtering scheme (page 10), Drive Strength/Output Impedance Selection (page 18), Recommended Operating Conditions (page 21), Electrical Characteristics (page 21), Power-Up Reset Timing (page 23), AC Signal Specifications (page 25), Link Port—Data Out Timing (page 28), Link Port—Data In Timing (page 31), and Ordering Guide (page 40).
- Provides unused pin termination data in Pin Function Descriptions (page 12).
- Changes pins R2 and R3 to NC in 576-Ball (25 mm × 25 mm) BGA_ED Pin Assignments (page 37).

GENERAL DESCRIPTION

The ADSP-TS202S TigerSHARC processor is an ultra-high performance, static superscalar processor optimized for large signal processing tasks and communications infrastructure. The DSP combines very wide memory widths with dual computation blocks—supporting 32- and 40-bit floating-point and supporting 8-, 16-, 32-, and 64-bit fixed-point processing—to set a new standard of performance for digital signal processors. The TigerSHARC static superscalar architecture lets the DSP execute up to four instructions each cycle, performing twenty-four 16-bit fixed-point operations or six floating-point operations.

Four independent 128-bit wide internal data buses, each connecting to the six 2M bit memory banks, enable quad-word data, instruction, and I/O accesses and provide 28G bytes per second of internal memory bandwidth. Operating at 500 MHz, the ADSP-TS202S processor's core has a 2.0 ns instruction cycle time. Using its Single-Instruction, Multiple-Data (SIMD) features, the ADSP-TS202S processor can perform four billion 40-bit MACs or one billion 80-bit MACs per second. Table 1 shows the DSP's performance benchmarks.

Table 1. General Purpose Algorithm Benchmarks at 500 MHz

| Benchmark | Speed | Clock Cycles |
|---------------------------------------------------------------|------------|--------------|
| 32-bit Algorithm, one billion MACs/s peak performance | | |
| 1K Point Complex FFT ¹ (Radix 2) | 18.8 μs | 9419 |
| 64K Point Complex FFT ¹ (Radix 2) | 2.8 ms | 1397544 |
| FIR Filter (per real tap) | 1 ns | 0.5 |
| [8 × 8][8 × 8] Matrix Multiply (Complex, Floating-point) | 2.8 μs | 1399 |
| 16-bit Algorithm, four billion MACs/s peak performance | | |
| 256 Point Complex FFT ¹ (Radix 2) | 1.9 μs | 928 |
| I/O DMA Transfer Rate | | |
| External port | 1G bytes/s | n/a |
| Link ports (each) | 1G bytes/s | n/a |

¹ Cache preloaded

The ADSP-TS202S processor is code-compatible with the other TigerSHARC processors.

The Functional Block Diagram on page 1 shows the ADSP-TS202S processor's architectural blocks. These blocks include:

- Dual compute blocks, each consisting of an ALU, multiplier, 64-bit shifter, and 32-word register file and associated Data Alignment Buffers (DABs)
- Dual integer ALUs (IALUs), each with its own 31-word register file for data addressing and a status register
- A program sequencer with Instruction Alignment Buffer (IAB) and Branch Target Buffer (BTB)
- An interrupt controller that supports hardware and software interrupts, supports level- or edge-triggers, and supports prioritized, nested interrupts

- Four 128-bit internal data buses, each connecting to the six 2M bit memory banks
- On-chip DRAM (12M bit)
- An external port that provides the interface to host processors, multiprocessing space (DSPs), off-chip memory-mapped peripherals, and external SRAM and SDRAM
- A 14 channel DMA controller
- Four full-duplex LVDS link ports
- Two 64-bit interval timers and timer expired pin
- A 1149.1 IEEE compliant JTAG test access port for on-chip emulation

Figure 2 on page 3 shows a typical single-processor system with external SRAM and SDRAM. Figure 4 on page 8 shows a typical multiprocessor system.

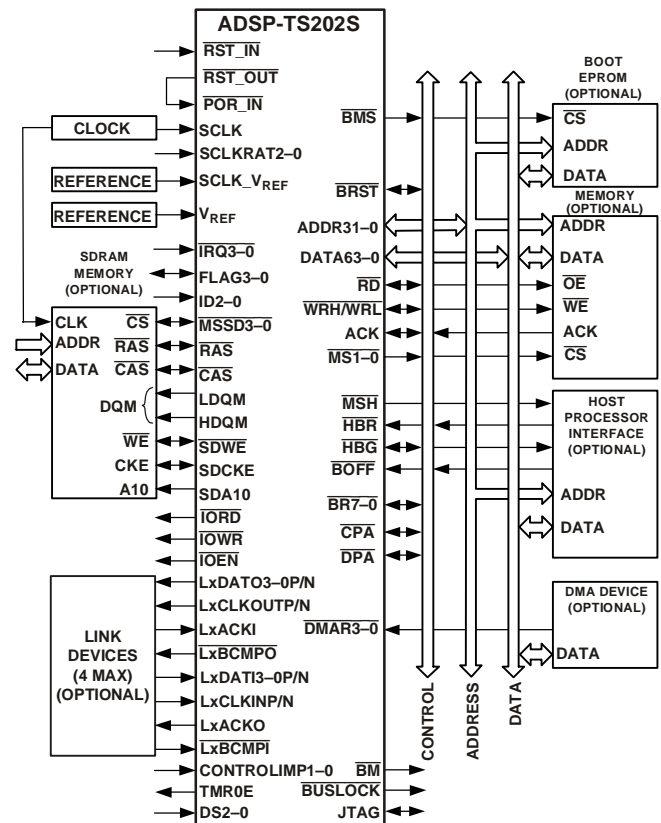

Figure 2. ADSP-TS202S Single-Processor System With External SDRAM

The TigerSHARC DSP uses a Static Superscalar[†] architecture. This architecture is superscalar in that the ADSP-TS202S processor's core can execute simultaneously from one to four 32-bit instructions encoded in a Very Large Instruction Word (VLIW) instruction line using the DSP's dual compute blocks. Because

[†] Static Superscalar™ is a trademark of Analog Devices, Inc.

the DSP does not perform instruction re-ordering at runtime—the programmer selects which operations will execute in parallel prior to runtime—the order of instructions is static.

With few exceptions, an instruction line, whether it contains one, two, three, or four 32-bit instructions, executes with a throughput of one cycle in a ten-deep processor pipeline.

For optimal DSP program execution, programmers must follow the DSP's set of instruction parallelism rules when encoding an instruction line. In general, the selection of instructions that the DSP can execute in parallel each cycle depends on the instruction line resources each instruction requires and on the source and destination registers used in the instructions. The programmer has direct control of three core components—the IALUs, the compute blocks, and the program sequencer.

The ADSP-TS202S processor, in most cases, has a two-cycle execution pipeline that is fully interlocked, so—whenever a computation result is unavailable for another operation dependent on it—the DSP automatically inserts one or more stall cycles as needed. Efficient programming with dependency-free instructions can eliminate most computational and memory transfer data dependencies.

In addition, the ADSP-TS202S processor supports SIMD operations two ways—SIMD compute blocks and SIMD computations. The programmer can load both compute blocks with the same data (broadcast distribution) or different data (merged distribution).

DUAL COMPUTE BLOCKS

The ADSP-TS202S processor has compute blocks that can execute computations either independently or together as a Single-Instruction, Multiple-Data (SIMD) engine. The DSP can issue up to two compute instructions per compute block each cycle, instructing the ALU, multiplier, or shifter to perform independent, simultaneous operations. Each compute block can execute eight 8-bit, four 16-bit, two 32-bit, or one 64-bit SIMD computations in parallel with the operation in the other block.

The compute blocks are referred to as X and Y in assembly syntax, and each block contains three computational units—an ALU, a multiplier, a 64-bit shifter—and a 32-word register file.

- **Register File**—Each Compute Block has a multiplexed 32-word, fully orthogonal register file used for transferring data between the computation units and data buses and for storing intermediate results. Instructions can access the registers in the register file individually (word-aligned), in sets of two (dual-aligned), or in sets of four (quad-aligned).
- **ALU**—The ALU performs a standard set of arithmetic operations in both fixed- and floating-point formats. It also performs logic and PERMUTE operations.
- **Multiplier**—The multiplier performs both fixed- and floating-point multiplication and fixed-point multiply and accumulate.
- **Shifter**—The 64-bit shifter performs logical and arithmetic shifts, bit and bitstream manipulation, and field deposit and extraction operations.

Using these features, the compute blocks can:

- Provide 8 MACs per cycle peak and 7.1 MACs per cycle sustained 16-bit performance and provide 2 MACs per cycle peak and 1.8 MACs per cycle sustained 32-bit performance (based on FIR)
- Execute six single-precision floating-point or execute twenty-four 16-bit fixed-point operations per cycle, providing 3 GFLOPS or 12.0 GOPS performance
- Perform two complex 16-bit MACs per cycle

DATA ALIGNMENT BUFFER (DAB)

The DAB is a quad-word FIFO that enables loading of quad-word data from nonaligned addresses. Normally, load instructions must be aligned to their data size so that quad words are loaded from a quad-aligned address. Using the DAB significantly improves the efficiency of some applications, such as FIR filters.

DUAL INTEGER ALU (IALU)

The ADSP-TS202S processor has two IALUs that provide powerful address generation capabilities and perform many general-purpose integer operations. The IALUs are referred to as J and K in assembly syntax and have the following features:

- Provides memory addresses for data and update pointers
- Supports circular buffering and bit-reverse addressing
- Performs general-purpose integer operations, increasing programming flexibility
- Includes a 31-word register file for each IALU

As address generators, the IALUs perform immediate or indirect (pre- and post-modify) addressing. They perform modulus and bit-reverse operations with no constraints placed on memory addresses for the modulus data buffer placement. Each IALU can specify either a single-, dual-, or quad-word access from memory.

The IALUs have hardware support for circular buffers, bit reverse, and zero-overhead looping. Circular buffers facilitate efficient programming of delay lines and other data structures required in digital signal processing, and they are commonly used in digital filters and Fourier transforms. Each IALU provides registers for four circular buffers, so applications can set up a total of eight circular buffers. The IALUs handle address pointer wraparound automatically, reducing overhead, increasing performance, and simplifying implementation. Circular buffers can start and end at any memory location.

Because the IALU's computational pipeline is one cycle deep, in most cases integer results are available in the next cycle. Hardware (register dependency check) causes a stall if a result is unavailable in a given cycle.

PROGRAM SEQUENCER

The ADSP-TS202S processor's program sequencer supports the following:

- A fully interruptible programming model with flexible programming in assembly and C/C++ languages; handles hardware interrupts with high throughput and no aborted instruction cycles
- A ten-cycle instruction pipeline—four-cycle fetch pipe and six-cycle execution pipe—computation results available two cycles after operands are available
- Supply of instruction fetch memory addresses; the sequencer's Instruction Alignment Buffer (IAB) caches up to five fetched instruction lines waiting to execute; the program sequencer extracts an instruction line from the IAB and distributes it to the appropriate core component for execution
- Management of program structures and program flow determined according to JUMP, CALL, RTI, RTS instructions, loop structures, conditions, interrupts, and software exceptions
- Branch prediction and a 128-entry branch target buffer (BTB) to reduce branch delays for efficient execution of conditional and unconditional branch instructions and zero-overhead looping; correctly predicted branches that are taken occur with zero overhead cycles, overcoming the five-to-nine stage branch penalty
- Compact code without the requirement to align code in memory; the IAB handles alignment

Interrupt Controller

The DSP supports nested and nonnested interrupts. Each interrupt type has a register in the interrupt vector table. Also, each has a bit in both the interrupt latch register and the interrupt mask register. All interrupts are fixed as either level-sensitive or edge-sensitive, except the $\overline{IRQ3-0}$ hardware interrupts, which are programmable.

The DSP distinguishes between hardware interrupts and software exceptions, handling them differently. When a software exception occurs, the DSP aborts all other instructions in the instruction pipe. When a hardware interrupt occurs, the DSP continues to execute instructions already in the instruction pipe.

Flexible Instruction Set

The 128-bit instruction line, which can contain up to four 32-bit instructions, accommodates a variety of parallel operations for concise programming. For example, one instruction line can direct the DSP to conditionally execute a multiply, an add, and a subtract in both computation blocks while it also branches to another location in the program. Some key features of the instruction set include:

- Algebraic assembly language syntax
- Direct support for all DSP, imaging, and video arithmetic types

- Eliminates toggling DSP hardware modes because modes are supported as options (for example, rounding, saturation, and others) within instructions
- Branch prediction encoded in instruction; enables zero-overhead loops
- Parallelism encoded in instruction line
- Conditional execution optional for all instructions
- User defined partitioning between program and data memory

DSP MEMORY

The DSP's internal and external memory is organized into a unified memory map, which defines the location (address) of all elements in the system, as shown in [Figure 3](#).

The memory map is divided into four memory areas—host space, external memory, multiprocessor space, and internal memory—and each memory space, except host memory, is subdivided into smaller memory spaces.

The ADSP-TS202S processor internal memory has 12M bits of on-chip DRAM memory, divided into six blocks of 2M bits (64K words \times 32 bits). Each block—M0, M2, M4, M6, M8, and M10—can store program, data, or both, so applications can configure memory to suit specific needs. Placing program instructions and data in different memory blocks, however, enables the DSP to access data while performing an instruction fetch. Each memory segment contains a 128K bit cache to enable single cycle accesses to internal DRAM.

The six internal memory blocks connect to the four 128-bit wide internal buses through a crossbar connection, enabling the DSP to perform four memory transfers in the same cycle. The DSP's internal bus architecture provides a total memory bandwidth of 28G bytes per second, enabling the core and I/O to access eight 32-bit data words and four 32-bit instructions each cycle. The DSP's flexible memory structure enables:

- DSP core and I/O accesses to different memory blocks in the same cycle
- DSP core access to three memory blocks in parallel—one instruction and two data accesses
- Programmable partitioning of program and data memory
- Program access of all memory as 32-, 64-, or 128-bit words—16-bit words with the DAB

EXTERNAL PORT (OFF-CHIP MEMORY/PERIPHERALS INTERFACE)

The ADSP-TS202S processor's external port provides the DSP's interface to off-chip memory and peripherals. The 4G word address space is included in the DSP's unified address space. The separate on-chip buses—four 128-bit data buses and four 32-bit address buses—are multiplexed at the SOC interface and transferred to the external port over the SOC bus to create an external system bus transaction. The external system bus provides a single 64-bit data bus and a single 32-bit address bus. The external port supports data transfer rates of 1G bytes per second over the external bus.

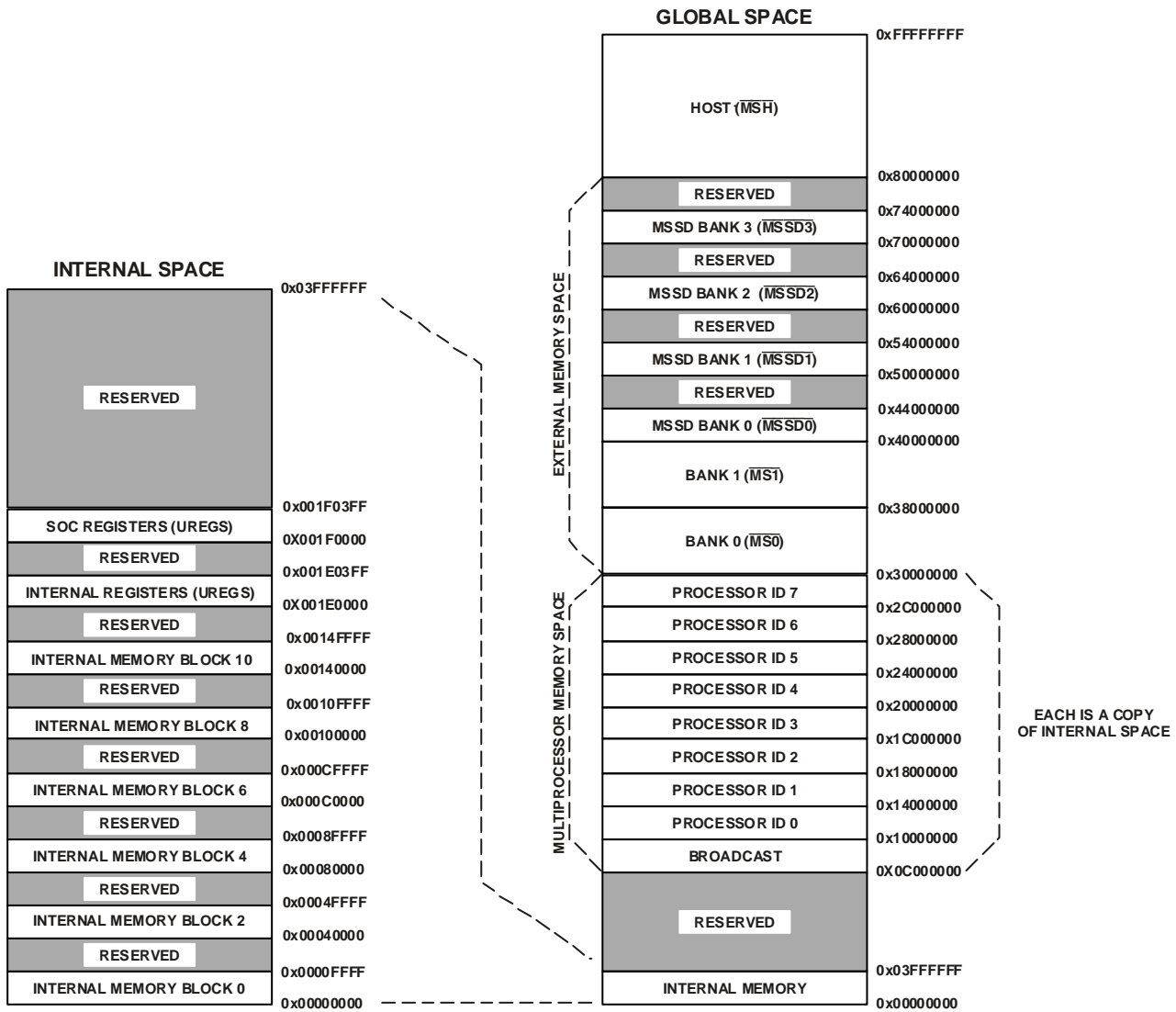

Figure 3. ADSP-TS202S Memory Map

The external bus can be configured for 32- or 64-bit, little-endian operations. When the system bus is configured for 64-bit operations, the lower 32 bits of the external data bus connect to even addresses, and the upper 32 bits connect to odd addresses.

The external port supports pipelined, slow, and SDRAM protocols. Addressing of external memory devices and memory-mapped peripherals is facilitated by on-chip decoding of high-order address lines to generate memory bank select signals.

The ADSP-TS202S processor provides programmable memory, pipeline depth, and idle cycle for synchronous accesses, and external acknowledge controls to support interfacing to pipelined or slow devices, host processors, and other memory-mapped peripherals with variable access, hold, and disable time requirements.

Host Interface

The ADSP-TS202S processor provides an easy and configurable interface between its external bus and host processors through the external port. To accommodate a variety of host processors, the host interface supports pipelined or slow protocols for ADSP-TS202S processor accesses of the host as slave or pipelined for host accesses of the ADSP-TS202S processor as slave. Each protocol has programmable transmission parameters, such as idle cycles, pipe depth, and internal wait cycles.

The host interface supports burst transactions initiated by a host processor. After the host issues the starting address of the burst and asserts the BRST signal, the DSP increments the address internally while the host continues to assert BRST.

The host interface provides a deadlock recovery mechanism that enables a host to recover from deadlock situations involving the DSP. The BOFF signal provides the deadlock recovery mecha-

nism. When the host asserts $\overline{\text{BOFF}}$, the DSP backs off the current transaction and asserts $\overline{\text{HBG}}$ and relinquishes the external bus.

The host can directly read or write the internal memory of the ADSP-TS202S processor, and it can access most of the DSP registers, including DMA control (TCB) registers. Vector interrupts support efficient execution of host commands.

Multiprocessor Interface

The ADSP-TS202S processor offers powerful features tailored to multiprocessing DSP systems through the external port and link ports. This multiprocessing capability provides highest bandwidth for interprocessor communication, including:

- Up to eight DSPs on a common bus
- On-chip arbitration for glueless multiprocessing
- Link ports for point to point communication

The external port and link ports provide integrated, glueless multiprocessing support.

The external port supports a unified address space (see Figure 3) that enables direct interprocessor accesses of each ADSP-TS202S processor's internal memory and registers. The DSP's on-chip distributed bus arbitration logic provides simple, glueless connection for systems containing up to eight ADSP-TS202S processors and a host processor. Bus arbitration has a rotating priority. Bus lock supports indivisible read-modify-write sequences for semaphores. A bus fairness feature prevents one DSP from holding the external bus too long.

The DSP's four link ports provide a second path for interprocessor communications with throughput of 4G bytes per second. The cluster bus provides 1G bytes per second throughput—with a total of 4G bytes per second interprocessor bandwidth (limited by SOC bandwidth).

SDRAM Controller

The SDRAM controller controls the ADSP-TS202S processor's transfers of data to and from external synchronous DRAM (SDRAM) at a throughput of 32 or 64 bits per SCLK cycle using the external port and SDRAM control pins.

The SDRAM interface provides a glueless interface with standard SDRAMs—16M bit, 64M bit, 128M bit, and 256M bit. The DSP supports directly a maximum of four banks of 64M words \times 32 bit of SDRAM. The SDRAM interface is mapped in external memory in each DSP's unified memory map.

EPROM Interface

The ADSP-TS202S processor can be configured to boot from an external 8-bit EPROM at reset through the external port. An automatic process (which follows reset) loads a program from the EPROM into internal memory. This process uses sixteen wait cycles for each read access. During booting, the $\overline{\text{BMS}}$ pin functions as the EPROM chip select signal. The EPROM boot procedure uses DMA channel 0, which packs the bytes into 32-bit instructions. Applications can also access the EPROM (write flash memories) during normal operation through DMA.

The EPROM or Flash Memory interface is not mapped in the DSP's unified memory map. It is a byte address space limited to a maximum of 16M bytes (twenty-four address bits). The EPROM or Flash Memory interface can be used after boot via a DMA.

DMA CONTROLLER

The ADSP-TS202S processor's on-chip DMA controller, with 14 DMA channels, provides zero-overhead data transfers without processor intervention. The DMA controller operates independently and invisibly to the DSP's core, enabling DMA operations to occur while the DSP's core continues to execute program instructions.

The DMA controller performs DMA transfers between internal memory and external memory and memory-mapped peripherals, the internal memory of other DSPs on a common bus, a host processor, or link port I/O; between external memory and external peripherals or link port I/O; and between an external bus master and internal memory or link port I/O. The DMA controller performs the following DMA operations:

- External port block transfers. Four dedicated bidirectional DMA channels transfer blocks of data between the DSP's internal memory and any external memory or memory-mapped peripheral on the external bus. These transfers support master mode and handshake mode protocols.
- Link port transfers. Eight dedicated DMA channels (four transmit and four receive) transfer quad-word data only between link ports and between a link port and internal or external memory. These transfers only use handshake mode protocol. DMA priority rotates between the four receive channels.
- AutoDMA transfers. Two dedicated unidirectional DMA channels transfer data received from an external bus master to internal memory or to link port I/O. These transfers only use slave mode protocol, and an external bus master must initiate the transfer.

The DMA controller provides these additional features:

- Flyby transfers. Flyby operations only occur through the external port (DMA channel 0) and do not involve the DSP's core. The DMA controller acts as a conduit to transfer data from an external I/O device and external SDRAM memory. During a transaction, the DSP relinquishes the external data bus; outputs addresses, memory selects ($\overline{\text{MSSD3-0}}$) and the $\overline{\text{IORD}}$, $\overline{\text{IOWR}}$, $\overline{\text{IOEN}}$, and $\overline{\text{RD}}/\overline{\text{WR}}$ strobes; and responds to ACK.
- DMA chaining. DMA chaining operations enable applications to automatically link one DMA transfer sequence to another for continuous transmission. The sequences can occur over different DMA channels and have different transmission attributes.
- Two-dimensional transfers. The DMA controller can access and transfer two-dimensional memory arrays on any DMA transmit or receive channel. These transfers are implemented with index, count, and modify registers for both the X and Y dimensions.

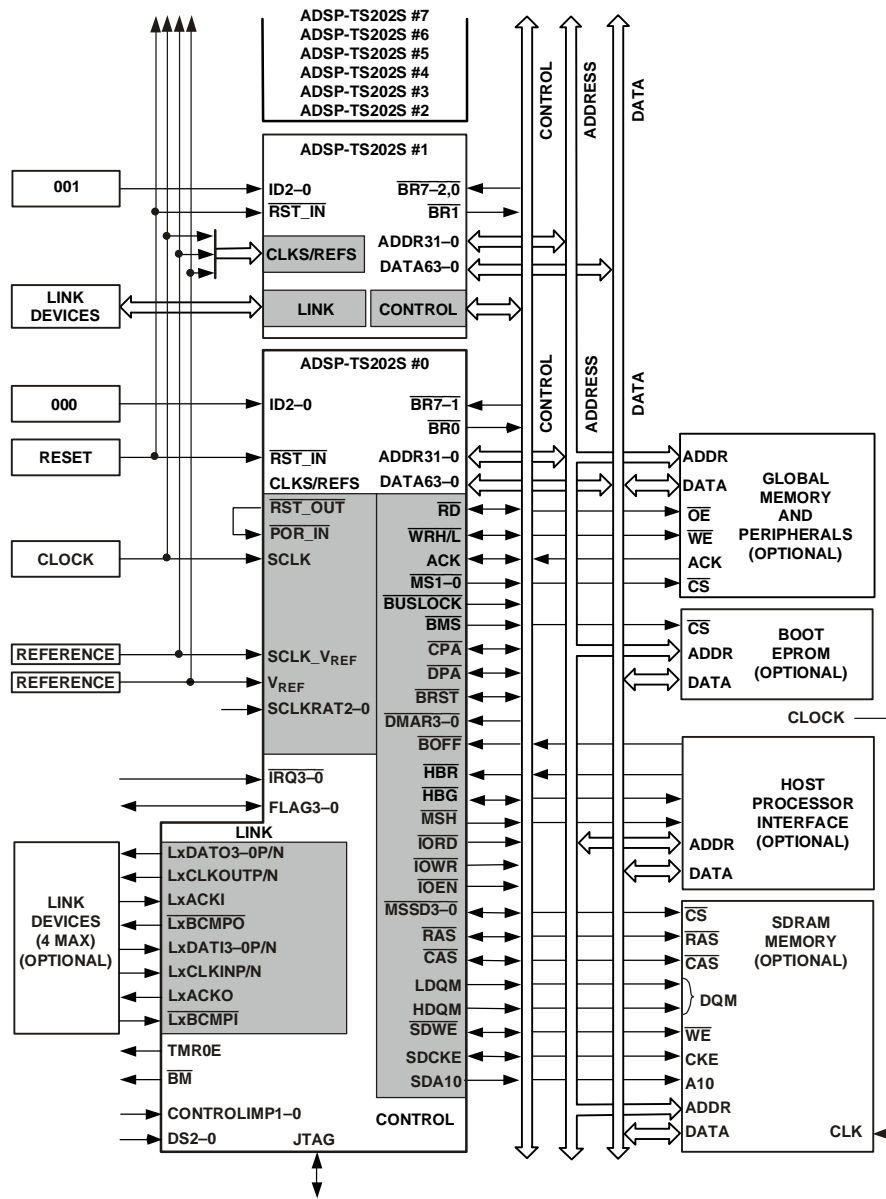

Figure 4. ADSP-TS202S Shared Memory Multiprocessing System

LINK PORTS (LVDS)

The DSP's four full-duplex link ports each provide additional four-bit receive and four-bit transmit I/O capability, using Low-Voltage, Differential-Signal (LVDS) technology. With the ability to operate at a double data rate—latching data on both the rising and falling edges of the clock—running at 500 MHz, each link port can support up to 500M bytes per second per direction, for a combined maximum throughput of 4G bytes per second.

The link ports provide an optional communications channel that is useful in multiprocessor systems for implementing point-to-point interprocessor communications. Applications can also use the link ports for booting.

Each link port has its own triple-buffered quad-word input and double-buffered quad-word output registers. The DSP's core can write directly to a link port's transmit register and read from a receive register, or the DMA controller can perform DMA transfers through eight (four transmit and four receive) dedicated link port DMA channels.

Each link port direction has three signals that control its operation. For the transmitter, LxCLKOUT is the output transmit clock, LxACKI is the handshake input to control the data flow, and the $\overline{\text{LxBCMPO}}$ output indicates that the block transfer is complete. For the receiver, LxCLKIN is the input receive clock, LxACKO is the handshake output to control the data flow, and

the $\overline{\text{LxBMPi}}$ input indicates that the block transfer is complete. The LxDAT03-0 pins are the data output bus for the transmitter and the LxDAT13-0 pins are the input data bus for the receiver.

Applications can program separate error detection mechanisms for transmit and receive operations (applications can use the checksum mechanism to implement consecutive link port transfers), the size of data packets, and the speed at which bytes are transmitted.

TIMER AND GENERAL-PURPOSE I/O

The ADSP-TS202S processor has a timer pin (TMR0E) that generates output when a programmed timer counter has expired and four programmable general-purpose I/O pins (FLAG3-0) that can function as either single-bit input or output. As outputs, these pins can signal peripheral devices; as inputs, they can provide the test for conditional branching.

RESET AND BOOTING

The ADSP-TS202S processor has three levels of reset:

- Power-up reset—After power-up of the system (SCLK, all static inputs, and strap pins are stable), the $\overline{\text{RST_IN}}$ pin must be asserted (low).
- Normal reset—For any chip reset following the power-up reset, the $\overline{\text{RST_IN}}$ pin must be asserted (low).
- DSP-core reset—When setting the SWRST bit in EMUCTL, the DSP core is reset, but not the external port or I/O.

For normal operations, tie the $\overline{\text{RST_OUT}}$ pin to the $\overline{\text{POR_IN}}$ pin.

After reset, the ADSP-TS202S processor has four boot options for beginning operation:

- Boot from EPROM.
- Boot by an external master (host or another ADSP-TS202S processor).
- Boot by link port.
- No boot—Start running from memory address selected with one of the $\overline{\text{IRQ3-0}}$ interrupt signals. See Table 2.

Using the ‘no boot’ option, the ADSP-TS202S processor must start running from memory when one of the interrupts is asserted.

Table 2. No Boot, Run From Memory Addresses

| Interrupt | Address |
|--------------------------|-------------------------------|
| $\overline{\text{IRQ0}}$ | 0x3000 0000 (External Memory) |
| $\overline{\text{IRQ1}}$ | 0x3800 0000 (External Memory) |
| $\overline{\text{IRQ2}}$ | 0x8000 0000 (External Memory) |
| $\overline{\text{IRQ3}}$ | 0x0000 0000 (Internal Memory) |

The ADSP-TS202S processor core always exits from reset in the idle state and waits for an interrupt. Some of the interrupts in the interrupt vector table are initialized and enabled after reset.

For more information on boot options, see the *EE-200: ADSP-TS20xS Boot Loader Kernels Operation* on the Analog Devices website (www.analog.com)

CLOCK DOMAINS

The DSP uses calculated ratios of the SCLK clock to operate as shown in Figure 5. The instruction execution rate is equal to CCLK. A PLL from SCLK generates CCLK which is phase-locked. The SCLKRATx pins define the clock multiplication of SCLK to CCLK (see Table 4 on page 12). The link port clock is generated from CCLK via a software programmable divisor, and the SOC bus operates at 1/2 CCLK. Memory transfers to external and link port buffers operate at the SOCCLK rate. SCLK also provides clock input for the external bus interface and defines the AC specification reference for the external bus signals. The external bus interface runs at the SCLK frequency. The maximum SCLK frequency is one quarter the internal DSP clock (CCLK) frequency.

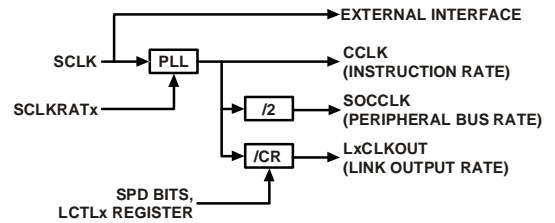

Figure 5. Clock Domains

POWER DOMAINS

The ADSP-TS202S processor has separate power supply connections for internal logic (V_{DD}), analog circuits (V_{DD_A}), I/O buffer (V_{DD_IO}), and internal DRAM (V_{DD_DRAM}) power supply.

Note that the analog (V_{DD_A}) supply powers the clock generator PLLs. To produce a stable clock, systems must provide a clean power supply to power input V_{DD_A} . Designs must pay critical attention to bypassing the V_{DD_A} supply.

FILTERING REFERENCE VOLTAGE AND CLOCKS

Figure 6 and Figure 7 show possible circuits for filtering V_{REF} and SCLK_V_{REF} . These circuits provide the reference voltages for the switching voltage reference and system clock reference.

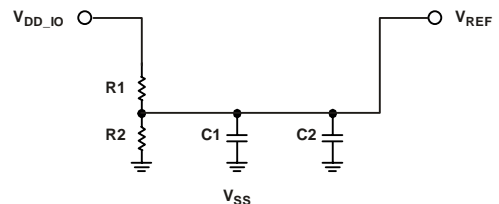

- R1: 2 kΩ SERIES RESISTOR (±1%)
- R2: 2.87 kΩ SERIES RESISTOR (±1%)
- C1: 1 μF CAPACITOR (SMD)
- C2: 1 nF CAPACITOR (HF SMD) PLACED CLOSE TO DSP'S PINS

Figure 6. V_{REF} Filtering Scheme

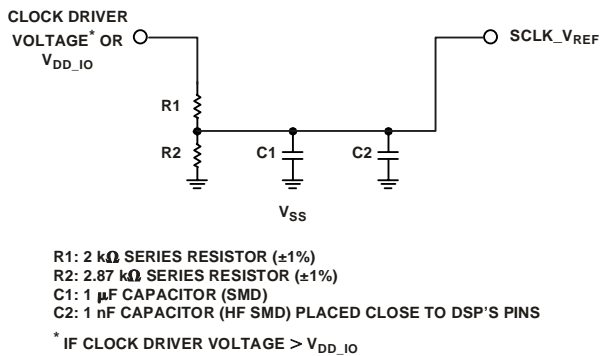

Figure 7. SCLK_VREF filtering scheme

DEVELOPMENT TOOLS

The ADSP-TS202S processor is supported with a complete set of CROSSCORE[†] software and hardware development tools, including Analog Devices emulators and VisualDSP++[‡] development environment. The same emulator hardware that supports other TigerSHARC processors also fully emulates the ADSP-TS202S processor.

The VisualDSP++ project management environment lets programmers develop and debug an application. This environment includes an easy to use assembler (which is based on an algebraic syntax), an archiver (librarian/library builder), a linker, a loader, a cycle-accurate instruction-level simulator, a C/C++ compiler, and a C/C++ runtime library that includes DSP and mathematical functions. A key point for these tools is C/C++ code efficiency. The compiler has been developed for efficient translation of C/C++ code to DSP assembly. The DSP has architectural features that improve the efficiency of compiled C/C++ code.

The VisualDSP++ debugger has a number of important features. Data visualization is enhanced by a plotting package that offers a significant level of flexibility. This graphical representation of user data enables the programmer to quickly determine the performance of an algorithm. As algorithms grow in complexity, this capability can have increasing significance on the designer's development schedule, increasing productivity. Statistical profiling enables the programmer to nonintrusively poll the processor as it is running the program. This feature, unique to VisualDSP++, enables the software developer to passively gather important code execution metrics without interrupting the realtime characteristics of the program. Essentially, the developer can identify bottlenecks in software quickly and efficiently. By using the profiler, the programmer can focus on those areas in the program that impact performance and take corrective action.

Debugging both C/C++ and assembly programs with the VisualDSP++ debugger, programmers can:

- View mixed C/C++ and assembly code (interleaved source and object information)
- Insert breakpoints
- Set conditional breakpoints on registers, memory, and stacks
- Trace instruction execution
- Perform linear or statistical profiling of program execution
- Fill, dump, and graphically plot the contents of memory
- Perform source level debugging
- Create custom debugger windows

The VisualDSP++ IDE lets programmers define and manage DSP software development. Its dialog boxes and property pages let programmers configure and manage all of the TigerSHARC processor development tools, including the color syntax highlighting in the VisualDSP++ editor. This capability permit programmers to:

- Control how the development tools process inputs and generate outputs
- Maintain a one-to-one correspondence with the tool's command line switches

The VisualDSP++™ Kernel (VDK) incorporates scheduling and resource management tailored specifically to address the memory and timing constraints of DSP programming. These capabilities enable engineers to develop code more effectively, eliminating the need to start from the very beginning, when developing new application code. The VDK features include Threads, Critical and Unscheduled regions, Semaphores, Events, and Device flags. The VDK also supports Priority-based, Preemptive, Cooperative and Time -Sliced scheduling approaches. In addition, the VDK was designed to be scalable. If the application does not use a specific feature, the support code for that feature is excluded from the target system.

Because the VDK is a library, a developer can decide whether to use it or not. The VDK is integrated into the VisualDSP++™ development environment, but can also be used via standard command line tools. When the VDK is used, the development environment assists the developer with many error-prone tasks and assists in managing system resources, automating the generation of various VDK based objects, and visualizing the system state, when debugging an application that uses the VDK.

VCSE is Analog Devices' technology for creating, using, and reusing software components (independent modules of substantial functionality) to quickly and reliably assemble software applications. Download components from the Web and drop them into the application. Publish component archives from within VisualDSP++™. VCSE supports component implementation in C/C++ or assembly language.

Use the Expert Linker to visually manipulate the placement of code and data on the embedded system. View memory utilization in a color-coded graphical form, easily move code and data to different areas of the DSP or external memory with the drag

[†] CROSSCORE is a registered trademark of Analog Devices, Inc.

[‡] VisualDSP++ is a registered trademark of Analog Devices, Inc.

of the mouse, examine run-time stack and heap usage. The Expert Linker is fully compatible with existing Linker Definition File (LDF), allowing the developer to move between the graphical and textual environments.

Analog Devices DSP emulators use the IEEE 1149.1 JTAG Test Access Port of the ADSP-TS202S processor to monitor and control the target board processor during emulation. The emulator provides full speed emulation, allowing inspection and modification of memory, registers, and processor stacks. Nonintrusive in-circuit emulation is assured by the use of the processor's JTAG interface—the emulator does not affect target system loading or timing.

In addition to the software and hardware development tools available from Analog Devices, third parties provide a wide range of tools supporting the TigerSHARC processor family. Hardware tools include TigerSHARC processor PC plug-in cards. Third party software tools include DSP libraries, real-time operating systems, and block diagram design tools.

DESIGNING AN EMULATOR-COMPATIBLE DSP BOARD (TARGET)

The Analog Devices family of emulators are tools that every DSP developer needs to test and debug hardware and software systems. Analog Devices has supplied an IEEE 1149.1 JTAG Test Access Port (TAP) on each JTAG DSP. The emulator uses the TAP to access the internal features of the DSP, allowing the developer to load code, set breakpoints, observe variables, observe memory, and examine registers. The DSP must be halted to send data and commands, but once an operation has been completed by the emulator, the DSP system is set running at full speed with no impact on system timing.

To use these emulators, the target board must include a header that connects the DSP's JTAG port to the emulator.

For details on target board design issues including mechanical layout, single processor connections, multiprocessor scan chains, signal buffering, signal termination, and emulator pod logic, see the *EE-68: Analog Devices JTAG Emulation Technical Reference* on the Analog Devices website (www.analog.com)—use site search on “EE-68”. This document is updated regularly to keep pace with improvements to emulator support.

ADDITIONAL INFORMATION

This data sheet provides a general overview of the ADSP-TS202S processor's architecture and functionality. For detailed information on the ADSP-TS202S processor's core architecture and instruction set, see the *ADSP-TS201 TigerSHARC Processor Hardware Reference* and the *ADSP-TS201 TigerSHARC Processor Programming Reference*. For detailed information on the development tools for this processor, see the *VisualDSP++ User's Guide for TigerSHARC Processors*.

PIN FUNCTION DESCRIPTIONS

While most of the ADSP-TS202S processor’s input pins are normally synchronous—tied to a specific clock—a few are asynchronous. For these asynchronous signals, an on-chip synchronization circuit prevents metastability problems. Use the AC specification for asynchronous signals when the system design requires predictable, cycle-by-cycle behavior for these signals.

The output pins can be three-stated during normal operation. The DSP three-states all outputs during reset, allowing these pins to get to their internal pullup or pulldown state. Some pins have an internal pullup or pulldown resistor ($\pm 30\%$ tolerance) that maintains a known value during transitions between different drivers.

Table 3. Pin Definitions—Clocks and Reset

| Signal | Type | Term | Description |
|------------------------------|----------------|------|--------------------------------------------------------------------------------------------------------------------------------------------------------------------------------------------------------------------------------------------------------------------------------------------------------------------------------------|
| SCLKRAT2-0 | I (pd) | au | Core Clock Ratio. The DSP’s core clock (CCLK) rate = $n \times \text{SCLK}$, where n is user-programmable using the SCLKRATx pins to the values shown in Table 4. These pins must have a constant value while the DSP is powered. The core clock rate (CCLK) is the instruction cycle rate. |
| SCLK | I ¹ | au | System Clock Input. The DSP’s system input clock for cluster bus. The core clock rate is user-programmable using the SCLKRATx pins. For more information, see Clock Domains on page 9 . |
| $\overline{\text{RST_IN}}$ | I/A | au | Reset. Sets the DSP to a known state and causes program to be in idle state. $\overline{\text{RST_IN}}$ must be asserted a specified time according to the type of reset operation. For details, see Reset and Booting on page 9 , Table 17 on page 23 , and Figure 10 on page 24 . |
| $\overline{\text{RST_OUT}}$ | O | au | Reset Output. Indicates that the DSP reset is complete. Connect to $\overline{\text{POR_IN}}$. |
| $\overline{\text{POR_IN}}$ | I/A | au | Power On Reset for internal DRAM. Connect to $\overline{\text{RST_OUT}}$. |

I = input; A = asynchronous; O = output; OD = open drain output; T = Three-State; P = power supply; G = ground; **pd** = internal pulldown 5 k Ω ; **pu** = internal pullup 5 k Ω ; **pd_0** = internal pulldown 5 k Ω on DSP ID=0; **pu_0** = internal pullup 5 k Ω on DSP ID=0; **pu_od_0** = internal pullup 500 Ω on DSP ID=0; **pd_m** = internal pulldown 5 k Ω on DSP bus master; **pu_m** = internal pullup 5 k Ω on DSP bus master; **pu_ad** = internal pullup 40 k Ω ; For more pulldown and pullup information, see [Electrical Characteristics on page 21](#).

Term (for termination) column symbols: epd = External pull-down approximately 5 k Ω to V_{SS} ; epu = External pull-up approximately 5 k Ω to V_{DD10} ; nc = Not connected; au = Always used.

¹ For more information on SCLK and SCLK_VREF on revision 0.x silicon, see the *EE-179: ADSP-TS20x TigerSHARC System Design Guidelines* on the Analog Devices website (www.analog.com).

Table 4. SCLK Ratio

| SCLKRAT2-0 | Ratio |
|---------------|----------|
| 000 (default) | 4 |
| 001 | 5 |
| 010 | 6 |
| 011 | 7 |
| 100 | 8 |
| 101 | 10 |
| 110 | 12 |
| 111 | Reserved |

Table 5. Pin Definitions—External Port Bus Controls

| Signal | Type | Term | Description |
|--------------------|-----------------------|------|-----------------------------------------------------------------------------------------------------------------------------------------------------------------------------------------------------------------------------------------------------------------------------------------------------------------------------------------------------------------------------------------------------------------------------------------------------------------------------------------------------------------------------------------------------------------------------------------------------------------------------------------------------------------------------|
| ADDR31–0 | I/O/T (pu_ad) | nc | Address Bus. The DSP issues addresses for accessing memory and peripherals on these pins. In a multiprocessor system, the bus master drives addresses for accessing internal memory or I/O processor registers of other ADSP-TS202S processors. The DSP inputs addresses when a host or another DSP accesses its internal memory or I/O processor registers. |
| DATA63–0 | I/O/T (pu_ad) | nc | External Data Bus. The DSP drives and receives data and instructions on these pins. Pullup/down resistors on unused DATA pins are unnecessary. |
| \overline{RD} | I/O/T (pu_0) | epu | Memory Read. \overline{RD} is asserted whenever the DSP reads from any slave in the system, excluding SDRAM. When the DSP is a slave, \overline{RD} is an input and indicates read transactions that access its internal memory or universal registers. In a multiprocessor system, the bus master drives \overline{RD} . \overline{RD} changes concurrently with ADDR pins. |
| \overline{WRL} | I/O/T (pu_0) | epu | Write Low. \overline{WRL} is asserted in two cases: When the ADSP-TS202S processor writes to an even address word of external memory or to another external bus agent; and when the ADSP-TS202S processor writes to a 32-bit zone (host, memory or DSP programmed to 32-bit bus). An external master (host or DSP) asserts \overline{WRL} for writing to a DSP's low word of internal memory. In a multiprocessor system, the bus master drives \overline{WRL} . \overline{WRL} changes concurrently with ADDR pins. When the DSP is a slave, \overline{WRL} is an input and indicates write transactions that access its internal memory or universal registers. |
| \overline{WRH} | I/O/T (pu_0) | epu | Write High. \overline{WRH} is asserted when the ADSP-TS202S processor writes a long word (64 bits) or writes to an odd address word of external memory or to another external bus agent on a 64-bit data bus. An external master (host or another DSP) must assert \overline{WRH} for writing to a DSP's high word of 64-bit data bus. In a multiprocessing system, the bus master drives \overline{WRH} . \overline{WRH} changes concurrently with ADDR pins. When the DSP is a slave, \overline{WRH} is an input and indicates write transactions that access its internal memory or universal registers. |
| ACK | I/O/T/OD (pu_od_0) | epu | Acknowledge. External slave devices can de-assert ACK to add wait states to external memory accesses. ACK is used by I/O devices, memory controllers and other peripherals on the data phase. The DSP can de-assert ACK to add wait states to read and write accesses of its internal memory. The pullup is 50 Ω on low-to-high transactions and is 500 Ω on all other transactions. |
| \overline{BMS} | O/T (pu_0) | au | Boot Memory Select. \overline{BMS} is the chip select for boot EPROM or flash memory. During reset, the DSP uses \overline{BMS} as a strap pin (EBOOT) for EPROM boot mode. In a multiprocessor system, the DSP bus master drives \overline{BMS} . For details, see Reset and Booting on page 9 and see the EBOOT signal description in Table 15 on page 19 . |
| $\overline{MS1-0}$ | O/T (pu_0) | nc | Memory Select. $\overline{MS0}$ or $\overline{MS1}$ is asserted whenever the DSP accesses memory banks 0 or 1 respectively. $\overline{MS1-0}$ are decoded memory address pins that change concurrently with ADDR pins. When ADDR31:27 = 0b00110, $\overline{MS0}$ is asserted. When ADDR31:27 = 0b00111, $\overline{MS1}$ is asserted. In multiprocessor systems, the master DSP drives $\overline{MS1-0}$. |
| \overline{MSH} | O/T (pu_0) | nc | Memory Select Host. \overline{MSH} is asserted whenever the DSP accesses the host address space (ADDR31 = 0b1). \overline{MSH} is a decoded memory address pin that changes concurrently with ADDR pins. In a multiprocessor system, the bus master DSP drives \overline{MSH} . |
| \overline{BRST} | I/O/T (pu_0) | epu | Burst. The current bus master (DSP or host) asserts this pin to indicate that it is reading or writing data associated with consecutive addresses. A slave device can ignore addresses after the first one and increment an internal address counter after each transfer. For host-to-DSP burst accesses, the DSP increments the address automatically while \overline{BRST} is asserted. |

I = input; A = asynchronous; O = output; OD = open drain output; T = Three-State; P = power supply; G = ground; **pd** = internal pulldown 5 k Ω ; **pu** = internal pullup 5 k Ω ; **pd_0** = internal pulldown 5 k Ω on DSP ID=0; **pu_0** = internal pullup 5 k Ω on DSP ID=0; **pu_od_0** = internal pullup 500 Ω on DSP ID=0; **pd_m** = internal pulldown 5 k Ω on DSP bus master; **pu_m** = internal pullup 5 k Ω on DSP bus master; **pu_ad** = internal pullup 40 k Ω ; For more pulldown and pullup information, see [Electrical Characteristics on page 21](#).

Term (for termination) column symbols: epd = External pull-down approximately 5 k Ω to V_{SS}; epu = External pull-up approximately 5 k Ω to V_{DD IO}; nc = Not connected; au = Always used.

Table 6. Pin Definitions—External Port Arbitration

| Signal | Type | Term | Description |
|----------------------|------------------|------------------|------------------------------------------------------------------------------------------------------------------------------------------------------------------------------------------------------------------------------------------------------------------------------------------------------------------------------------------------------------------------------------------------------------------------------------------------------------------------------------------------------------------------------------------------------------------------------------------------------------------------------------------------------------------------------------------------------------------------------------------------------------------------------------------------|
| $\overline{BR7-0}$ | I/O | $V_{DD_{IO}}$ | Multiprocessing Bus Request Pins. Used by the DSPs in a multiprocessor system to arbitrate for bus mastership. Each DSP drives its own \overline{BRx} line (corresponding to the value of its ID2–0 inputs) and monitors all others. In systems with fewer than eight DSPs, set the unused \overline{BRx} pins high ($V_{DD_{IO}}$). |
| ID2–0 | I (pd) | au | Multiprocessor ID. Indicates the DSP’s ID, from which the DSP determines its order in a multiprocessor system. These pins also indicate to the DSP which bus request ($\overline{BR0-7}$) to assert when requesting the bus: 000 = $\overline{BR0}$, 001 = $\overline{BR1}$, 010 = $\overline{BR2}$, 011 = $\overline{BR3}$, 100 = $\overline{BR4}$, 101 = $\overline{BR5}$, 110 = $\overline{BR6}$, or 111 = $\overline{BR7}$. ID2–0 must have a constant value during system operation and can change during reset only. |
| \overline{BM} | O | au | Bus Master. The current bus master DSP asserts \overline{BM} . For debugging only. At reset this is a strap pin. For more information, see Table 15 on page 19 . |
| \overline{BOFF} | I | epu | Back Off. A deadlock situation can occur when the host and a DSP try to read from each other’s bus at the same time. When deadlock occurs, the host can assert \overline{BOFF} to force the DSP to relinquish the bus before completing its outstanding transaction. |
| $\overline{BUSLOCK}$ | O/T (pu_0) | au | Bus Lock Indication. Provides an indication that the current bus master has locked the bus. At reset, this is a strap pin. For more information, see Table 15 on page 19 . |
| \overline{HBR} | I | epu | Host Bus Request. A host must assert \overline{HBR} to request control of the DSP’s external bus. When \overline{HBR} is asserted in a multiprocessing system, the bus master relinquishes the bus and asserts \overline{HBG} once the outstanding transaction is finished. |
| \overline{HBG} | I/O/T (pu_0) | epu ¹ | Host Bus Grant. Acknowledges \overline{HBR} and indicates that the host can take control of the external bus. When relinquishing the bus, the master DSP three-states the $\overline{ADDR31-0}$, $\overline{DATA63-0}$, \overline{MSH} , $\overline{MSSD3-0}$, $\overline{MS1-0}$, \overline{RD} , \overline{WRL} , \overline{WRH} , \overline{BMS} , \overline{BRST} , \overline{IORD} , \overline{IOWR} , \overline{IOEN} , \overline{RAS} , \overline{CAS} , \overline{SDWE} , SDA10, SDCKE, LDQM and HDQM pins, and the DSP puts the SDRAM in self-refresh mode. The DSP asserts \overline{HBG} until the host deasserts \overline{HBR} . In multiprocessor systems, the current bus master DSP drives \overline{HBG} , and all slave DSPs monitor it. |
| \overline{CPA} | I/O/OD (pu_od_0) | epu | Core Priority Access. Asserted while the DSP’s core accesses external memory. This pin enables a slave DSP to interrupt a master DSP’s background DMA transfers and gain control of the external bus for core-initiated transactions. \overline{CPA} is an open drain output, connected to all DSPs in the system. If not required in the system, leave \overline{CPA} unconnected (external pullups will be required for DSP ID=1 through ID=7). |
| \overline{DPA} | I/O/OD (pu_od_0) | epu | DMA Priority Access. Asserted while a high-priority DSP DMA channel accesses external memory. This pin enables a high-priority DMA channel on a slave DSP to interrupt transfers of a normal-priority DMA channel on a master DSP and gain control of the external bus for DMA-initiated transactions. \overline{DPA} is an open drain output, connected to all DSPs in the system. If not required in the system, leave \overline{DPA} unconnected (external pullups will be required for DSP ID=1 through ID=7). |

I = input; A = asynchronous; O = output; OD = open drain output; T = Three-State; P = power supply; G = ground; **pd** = internal pulldown 5 kΩ; **pu** = internal pullup 5 kΩ; **pd_0** = internal pulldown 5 kΩ on DSP ID=0; **pu_0** = internal pullup 5 kΩ on DSP ID=0; **pu_od_0** = internal pullup 500Ω on DSP ID=0; **pd_m** = internal pulldown 5 kΩ on DSP bus master; **pu_m** = internal pullup 5 kΩ on DSP bus master; **pu_ad** = internal pullup 40 kΩ; For more pulldown and pullup information, see [Electrical Characteristics on page 21](#).

Term (for termination) column symbols: epd = External pull-down approximately 5 kΩ to V_{SS} ; epu = External pull-up approximately 5 kΩ to $V_{DD_{IO}}$; nc = Not connected; au = Always used.

¹ This external pull-up resistor may be omitted for the ID=000 TigerSHARC processor.

Table 7. Pin Definitions—External Port DMA/Flyby

| Signal | Type | Term | Description |
|--------------------------|---------------|------|------------------------------------------------------------------------------------------------------------------------------------------------------------------------------------------------------------------------------------------------------------------------|
| DMAR3-0 | I/A | epu | DMA Request Pins. Enable external I/O devices to request DMA services from the DSP. In response to $\overline{\text{DMARx}}$, the DSP performs DMA transfers according to the DMA channel's initialization. The DSP ignores DMA requests from uninitialized channels. |
| $\overline{\text{IOWR}}$ | O/T (pu_0) | nc | I/O Write. When a DSP DMA channel initiates a flyby mode read transaction, the DSP asserts the $\overline{\text{IOWR}}$ signal during the data cycles. This assertion makes the I/O device sample the data instead of the TigerSHARC. |
| $\overline{\text{IORD}}$ | O/T (pu_0) | nc | I/O Read. When a DSP DMA channel initiates a flyby mode write transaction, the DSP asserts the $\overline{\text{IORD}}$ signal during the data cycle. This assertion with the $\overline{\text{IOEN}}$ makes the I/O device drive the data instead of the TigerSHARC. |
| $\overline{\text{IOEN}}$ | O/T (pu_0) | nc | I/O Device Output Enable. Enables the output buffers of an external I/O device for fly-by transactions between the device and external memory. Active on fly-by transactions. |

I = input; A = asynchronous; O = output; OD = open drain output; T = Three-State; P = power supply; G = ground; **pd** = internal pulldown 5 kΩ; **pu** = internal pullup 5 kΩ; **pd_0** = internal pulldown 5 kΩ on DSP ID=0; **pu_0** = internal pullup 5 kΩ on DSP ID=0; **pu_od_0** = internal pullup 500Ω on DSP ID=0; **pd_m** = internal pulldown 5 kΩ on DSP bus master; **pu_m** = internal pullup 5 kΩ on DSP bus master; **pu_ad** = internal pullup 40 kΩ; For more pulldown and pullup information, see [Electrical Characteristics on page 21](#).

Term (for termination) column symbols: epd = External pull-down approximately 5 kΩ to V_{SS} ; epu = External pull-up approximately 5 kΩ to $V_{DD_{IO}}$; nc = Not connected; au = Always used.

Table 8. Pin Definitions—External Port SDRAM Controller

| Signal | Type | Term | Description |
|-------------------------|-----------------|------|-----------------------------------------------------------------------------------------------------------------------------------------------------------------------------------------------------------------------------------------------------------------------------------------------------------------------------------------------------------------------------------------------------------------------------------------------------------------------------------------------------------------|
| MSSD3-0 | I/O/T (pu_0) | nc | Memory Select SDRAM. $\overline{\text{MSSD0}}$, $\overline{\text{MSSD1}}$, $\overline{\text{MSSD2}}$, or $\overline{\text{MSSD3}}$ is asserted whenever the DSP accesses SDRAM memory space. $\overline{\text{MSSD3-0}}$ are decoded memory address pins that are asserted whenever the DSP issues an SDRAM command cycle (access to ADDR31:30 = 0b01—except reserved spaces shown in Figure 3 on page 6). In a multi-processor system, the master DSP drives $\overline{\text{MSSD3-0}}$. |
| $\overline{\text{RAS}}$ | I/O/T (pu_0) | nc | Row Address Select. When sampled low, $\overline{\text{RAS}}$ indicates that a row address is valid in a read or write of SDRAM. In other SDRAM accesses, it defines the type of operation to execute according to SDRAM specification. |
| $\overline{\text{CAS}}$ | I/O/T (pu_0) | nc | Column Address Select. When sampled low, $\overline{\text{CAS}}$ indicates that a column address is valid in a read or write of SDRAM. In other SDRAM accesses, it defines the type of operation to execute according to the SDRAM specification. |
| LDQM | O/T (pu_0) | nc | Low Word SDRAM Data Mask. When sampled high, three-states the SDRAM DQ buffers. LDQM is valid on SDRAM transactions when $\overline{\text{CAS}}$ is asserted, and inactive on read transactions. On write transactions, LDQM is active when accessing an odd address word on a 64-bit memory bus to disable the write of the low word. |
| HDQM | O/T (pu_0) | nc | High Word SDRAM Data Mask. When sampled high, three-states the SDRAM DQ buffers. HDQM is valid on SDRAM transactions when $\overline{\text{CAS}}$ is asserted, and inactive on read transactions. On write transactions, HDQM is active when accessing an even address in word accesses or when memory is configured for a 32-bit bus to disable the write of the high word. |

I = input; A = asynchronous; O = output; OD = open drain output; T = Three-State; P = power supply; G = ground; **pd** = internal pulldown 5 kΩ; **pu** = internal pullup 5 kΩ; **pd_0** = internal pulldown 5 kΩ on DSP ID=0; **pu_0** = internal pullup 5 kΩ on DSP ID=0; **pu_od_0** = internal pullup 500Ω on DSP ID=0; **pd_m** = internal pulldown 5 kΩ on DSP bus master; **pu_m** = internal pullup 5 kΩ on DSP bus master; **pu_ad** = internal pullup 40 kΩ; For more pulldown and pullup information, see [Electrical Characteristics on page 21](#).

Term (for termination) column symbols: epd = External pull-down approximately 5 kΩ to V_{SS} ; epu = External pull-up approximately 5 kΩ to $V_{DD_{IO}}$; nc = Not connected; au = Always used.

Table 8. Pin Definitions—External Port SDRAM Controller (Continued)

| Signal | Type | Term | Description |
|-------------------|--------------------------|------|-------------------------------------------------------------------------------------------------------------------------------------------------------------------------------------------------------------------------------------------------------------------------------------------------------------------------------------------------------------------------------------------------------------------|
| SDA10 | O/T (pu_0) | nc | SDRAM Address bit 10 pin. Separate A10 signals enable SDRAM refresh operation while the DSP executes non-SDRAM transactions. |
| SDCKE | I/O/T (pu_m/ pd_m) | nc | SDRAM Clock Enable. Activates the SDRAM clock for SDRAM self-refresh or suspend modes. A slave DSP in a multiprocessor system does not have the pullup or pulldown. A master DSP (or ID=0 in a single processor system) has a pullup before granting the bus to the host, except when the SDRAM is put in self refresh mode. In self refresh mode, the master has a pulldown before granting the bus to the host. |
| \overline{SDWE} | I/O/T (pu_0) | nc | SDRAM Write Enable. When sampled low while \overline{CAS} is active, \overline{SDWE} indicates an SDRAM write access. When sampled high while \overline{CAS} is active, \overline{SDWE} indicates an SDRAM read access. In other SDRAM accesses, \overline{SDWE} defines the type of operation to execute according to SDRAM specification. |

I = input; A = asynchronous; O = output; OD = open drain output; T = Three-State; P = power supply; G = ground;
pd = internal pulldown 5 k Ω ; **pu** = internal pullup 5 k Ω ; **pd_0** = internal pulldown 5 k Ω on DSP ID=0; **pu_0** = internal pullup 5 k Ω on DSP ID=0; **pu_od_0** = internal pullup 500 Ω on DSP ID=0; **pd_m** = internal pulldown 5 k Ω on DSP bus master; **pu_m** = internal pullup 5 k Ω on DSP bus master; **pu_ad** = internal pullup 40 k Ω ; For more pulldown and pullup information, see [Electrical Characteristics on page 21](#).

Term (for termination) column symbols: epd = External pull-down approximately 5 k Ω to V_{SS} ; epu = External pull-up approximately 5 k Ω to $V_{DD_{IO}}$; nc = Not connected; au = Always used.

Table 9. Pin Definitions—JTAG Port

| Signal | Type | Term | Description |
|-------------------|----------------|-------------------------|------------------------------------------------------------------------------------------------------------------------------------------------------------------------------------------------------------------------|
| \overline{EMU} | O/OD | nc ¹ | Emulation. Connected to the DSP's JTAG emulator target board connector only. |
| TCK | I | epd or epu ¹ | Test Clock (JTAG). Provides an asynchronous clock for JTAG scan. |
| TDI | I (pu_ad) | nc ¹ | Test Data Input (JTAG). A serial data input of the scan path. |
| TDO | O/T | nc ¹ | Test Data Output (JTAG). A serial data output of the scan path. |
| TMS | I (pu_ad) | nc ¹ | Test Mode Select (JTAG). Used to control the test state machine. |
| \overline{TRST} | I/A (pu_ad) | au | Test Reset (JTAG). Resets the test state machine. \overline{TRST} must be asserted or pulsed low after power up for proper device operation. For more information, see Reset and Booting on page 9 . |

I = input; A = asynchronous; O = output; OD = open drain output; T = Three-State; P = power supply; G = ground;
pd = internal pulldown 5 k Ω ; **pu** = internal pullup 5 k Ω ; **pd_0** = internal pulldown 5 k Ω on DSP ID=0; **pu_0** = internal pullup 5 k Ω on DSP ID=0; **pu_od_0** = internal pullup 500 Ω on DSP ID=0; **pd_m** = internal pulldown 5 k Ω on DSP bus master; **pu_m** = internal pullup 5 k Ω on DSP bus master; **pu_ad** = internal pullup 40 k Ω ; For more pulldown and pullup information, see [Electrical Characteristics on page 21](#)

Term (for termination) column symbols: epd = External pull-down approximately 5 k Ω to V_{SS} ; epu = External pull-up approximately 5 k Ω to $V_{DD_{IO}}$; nc = Not connected; au = Always used.

¹ See the reference on page 11 to the JTAG emulation technical reference EE-68.

Table 10. Pin Definitions—Flags, Interrupts, and Timer

| Signal | Type | Term | Description |
|------------------------------------|---------------|------|----------------------------------------------------------------------------------------------------------------------------------------------------------------------------------------------------------------------------------------------------------------------------------------------------------------------------------------------------|
| FLAG3–0 | I/O/A (pu) | nc | FLAG pins. Bidirectional input/output pins can be used as program conditions. Each pin can be configured individually for input or for output. FLAG3–0 are inputs after power-up and reset. |
| $\overline{\text{IRQ3}}\text{--}0$ | I/A (pu) | nc | Interrupt Request. When asserted, the DSP generates an interrupt. Each of the $\overline{\text{IRQ3}}\text{--}0$ pins can be independently set for edge-triggered or level-sensitive operation. After reset, these pins are disabled unless the $\overline{\text{IRQ3}}\text{--}0$ strap option and interrupt vectors are initialized for booting. |
| TMROE | O | au | Timer 0 expires. This output pulses whenever timer 0 expires. At reset, this is a strap pin. For more information, see Table 15 on page 19 . |

I = input; A = asynchronous; O = output; OD = open drain output; T = Three-State; P = power supply; G = ground; **pd** = internal pulldown 5 k Ω ; **pu** = internal pullup 5 k Ω ; **pd_0** = internal pulldown 5 k Ω on DSP ID=0; **pu_0** = internal pullup 5 k Ω on DSP ID=0; **pu_od_0** = internal pullup 500 Ω on DSP ID=0; **pd_m** = internal pulldown 5 k Ω on DSP bus master; **pu_m** = internal pullup 5 k Ω on DSP bus master; **pu_ad** = internal pullup 40 k Ω ; For more pulldown and pullup information, see [Electrical Characteristics on page 21](#).

Term (for termination) column symbols: epd = External pull-down approximately 5 k Ω to V_{SS} ; epu = External pull-up approximately 5 k Ω to $V_{DD_{IO}}$; nc = Not connected; au = Always used.

Table 11. Pin Definitions—Link Ports

| Signal | Type | Term | Description |
|-----------------------------|--------|-----------------|-------------------------------------------------------------------------------------------------------------------------------------------------------------------------------------------------------------------------------------------------------------------------------------------------------------------------------------------------------------|
| LxDATO3–0P | O | nc | Link Ports 3–0 Data 3–0 Transmit LVDS P |
| LxDATO3–0N | O | nc | Link Ports 3–0 Data 3–0 Transmit LVDS N |
| LxCLKOUTP | O | nc | Link Ports 3–0 Transmit Clock LVDS P |
| LxCLKOUTN | O | nc | Link Ports 3–0 Transmit Clock LVDS N |
| LxACKI | I (pd) | nc | Link Ports 3–0 Receive Acknowledge. Using this signal, the receiver indicates to the transmitter that it may continue the transmission |
| $\overline{\text{LxBCMPO}}$ | O | nc ¹ | Link Ports 3–0 Block Completion. When the transmission is executed using DMA, this signal indicates to the receiver that the transmitted block is completed. At reset, the $\overline{\text{L1BCMPO}}$, $\overline{\text{L2BCMPO}}$, and $\overline{\text{L3BCMPO}}$ pins are strap pins. For more information, see Table 15 on page 19 . |
| LxDATI3–0P | I | $V_{DD_{IO}}$ | Link Ports 3–0 Data 3–0 Receive LVDS P |
| LxDATI3–0N | I | $V_{DD_{IO}}$ | Link Ports 3–0 Data 3–0 Receive LVDS N |
| LxCLKINP | I/A | $V_{DD_{IO}}$ | Link Ports 3–0 Receive Clock LVDS P |
| LxCLKINN | I/A | V_{SS} | Link Ports 3–0 Receive Clock LVDS N |
| LxACKO | O | nc | Link Ports 3–0 Transmit Acknowledge. Using this signal, the receiver indicates to the transmitter that it may continue the transmission. |
| $\overline{\text{LxBCMPI}}$ | I | V_{SS} | Link Ports 3–0 Block Completion. When the reception is executed using DMA, this signal indicates to the transmitter that the receive block is completed. |

I = input; A = asynchronous; O = output; OD = open drain output; T = Three-State; P = power supply; G = ground; **pd** = internal pulldown 5 k Ω ; **pu** = internal pullup 5 k Ω ; **pd_0** = internal pulldown 5 k Ω on DSP ID=0; **pu_0** = internal pullup 5 k Ω on DSP ID=0; **pu_od_0** = internal pullup 500 Ω on DSP ID=0; **pd_m** = internal pulldown 5 k Ω on DSP bus master; **pu_m** = internal pullup 5 k Ω on DSP bus master; **pu_ad** = internal pullup 40 k Ω ; For more pulldown and pullup information, see [Electrical Characteristics on page 21](#).

Term (for termination) column symbols: epd = External pull-down approximately 5 k Ω to V_{SS} ; epu = External pull-up approximately 5 k Ω to $V_{DD_{IO}}$; nc = Not connected; au = Always used.

¹The $\overline{\text{L1BCMPO}}$ and $\overline{\text{L2BCMPO}}$ pins have different termination requirements on revision 0.x silicon, see the *EE-179: ADSP-TS20xS TigerSHARC System Design Guidelines* on the Analog Devices website (www.analog.com).

Table 12. Pin definitions—Impedance Control , Drive Strength Control, and Regulator Enable

| Signal | Type | Term | Description |
|--------------|------------------|-----------------|------------------------------------------------------------------------------------------------------------------------------------------------------------------------------------------------------------------------------------------------------------------------------------------------------------------------------------------------------------------------------------------------------------------------------------------------------------------------------------------------------------------------------------------------------------------------------|
| CONTROLIMP0 | I (pd) | au | Impedance Control. CONTROLIMP0 enables Pulse Mode. When CONTROLIMP0 = 0, Pulse Mode is disabled and the output drive strength is continuously controlled by DS2–0, both in the digital mode and in the analog mode (See analog and digital modes below). When CONTROLIMP0 = 1, Pulse Mode is enabled. In Pulse Mode, whenever a new value is driven to the output pin, drive strength is set to 100% for a short period of 1.5–2.5ns after rising edge of SCLK and afterwards it is set back to the value defined by the resistance control DS2–0 pins as shown in Table 13. |
| CONTROLIMP1 | I (pu) | au | Impedance Control. CONTROLIMP1 enables A/D mode of the control impedance circuitry. When CONTROLIMP1 = 0, A/D mode is disabled, and output drive strength is set relative to maximum drive strength according to table in DS2–0 explanation. When CONTROLIMP1 = 1, A/D mode is enabled, and the resistance control operates in the analog mode, where drive strength is continuously controlled to match a specific line impedance as shown in Table 13. |
| DS2,0 DS1 | I (pu) I (pd) | au | Digital Drive Strength Selection. Selected as shown in Table 13. For drive strength calculation, see Output Drive Currents on page 32 . The drive strength for some pins is preset, not controlled by the DS2–0 pins. The pins that are always at drive strength 7 (100%) include: CPA, DPA, TDO, EMU, and RST_OUT. The drive strength for the ACK pin is always x2 drive strength 7 (100%). |
| ENEDREG | I (pu) | V _{SS} | Enable on-chip DRAM regulator. Connect the ENEDREG pin to V _{SS} . Connect the V _{DD_DRAM} pins to a properly decoupled DRAM power supply. |

I = input; A = asynchronous; O = output; OD = open drain output; T = Three-State; P = power supply; G = ground;
 pd = internal pulldown 5 kΩ; pu = internal pullup 5 kΩ; pd_0 = internal pulldown 5 kΩ on DSP ID=0; pu_0 = internal pullup 5 kΩ on DSP ID=0; pu_od_0 = internal pullup 500Ω on DSP ID=0; pd_m = internal pulldown 5 kΩ on DSP bus master; pu_m = internal pullup 5 kΩ on DSP bus master; pu_ad = internal pullup 40 kΩ; For more pulldown and pullup information, see [Electrical Characteristics on page 21](#).

Term (for termination) column symbols: epd = External pull-down approximately 5 kΩ to V_{SS}; epu = External pull-up approximately 5 kΩ to V_{DD_IO}; nc = Not connected; au = Always used.

Table 13. Drive Strength/Output Impedance Selection

| DS2–0 Pins | Drive Strength ¹ | Output Impedance ² |
|---------------|-----------------------------|-------------------------------|
| 000 | Strength 0 (11.1%) | 26 Ω |
| 001 | Strength 1 (23.8%) | 32 Ω |
| 010 | Strength 2 (36.5%) | 40 Ω |
| 011 | Strength 3 (49.2%) | 50 Ω |
| 100 | Strength 4 (61.9%) | 62 Ω |
| 101 (default) | Strength 5 (74.6%) | 70 Ω |
| 110 | Strength 6 (87.3%) | 96 Ω |
| 111 | Strength 7 (100%) | 120 Ω |

¹ CONTROLIMP1 = 0, A/D mode disabled.

² CONTROLIMP1 = 1, A/D mode enabled.

Table 14. Pin Definitions—Power, Ground, and Reference

| Signal | Type | Term | Description |
|-----------------------|----------------|------|-----------------------------------------------------------------------------------------------------------------------------------------------------------------------------------------------------------------------------------------------------------------------------------------------------------------------------------------------------------------------------------------------------------------------------------------------------------------------------------------------------------------------------------------------------------------------|
| V _{DD} | P | au | V _{DD} pins for internal logic. |
| V _{DD_A} | P | au | V _{DD} pins for analog circuits. Pay critical attention to bypassing this supply. |
| V _{DD_IO} | P | au | V _{DD} pins for I/O buffers. |
| V _{DD_DRAM} | P | au | V _{DD} pins for internal DRAM. |
| V _{REF} | I | au | Reference voltage defines the trip point for all input buffers, except SCLK, $\overline{\text{RST_IN}}$, $\overline{\text{POR_IN}}$, $\overline{\text{IRQ3-0}}$, $\overline{\text{FLAG3-0}}$, $\overline{\text{DMAR3-0}}$, ID2-0, CONTROLIMP1-0, LxDATO3-0P/N, LxCLKOUTP/N, LxDATI3-0P/N, LxCLKINP/N, TCK, TDI, TMS, and $\overline{\text{TRST}}$. V _{REF} can be connected to a power supply or set by a voltage divider circuit as shown in Figure 6. For more information, see Filtering Reference Voltage and Clocks on page 9 . |
| SCLK_V _{REF} | I ¹ | au | System Clock Reference. Connect this pin to a reference voltage as shown in Figure 7. For more information, see Filtering Reference Voltage and Clocks on page 9 . |
| V _{SS} | G | au | Ground pins. |
| NC | — | nc | No Connect. Do not connect these pins to anything (not to any supply, signal, or each other). These pins are reserved and must be left unconnected. |

I = input; A = asynchronous; O = output; OD = open drain output; T = Three-State; P = power supply; G = ground; **pd** = internal pulldown 5 kΩ; **pu** = internal pullup 5 kΩ; **pd_0** = internal pulldown 5 kΩ on DSP ID=0; **pu_0** = internal pullup 5 kΩ on DSP ID=0; **pu_od_0** = internal pullup 500Ω on DSP ID=0; **pd_m** = internal pulldown 5 kΩ on DSP bus master; **pu_m** = internal pullup 5 kΩ on DSP bus master; **pu_ad** = internal pullup 40 kΩ; For more pulldown and pullup information, see [Electrical Characteristics on page 21](#).

Term (for termination) column symbols: epd = External pull-down approximately 5 kΩ to V_{SS}; epu = External pull-up approximately 5 kΩ to V_{DD_IO}; nc = Not connected; au = Always used.

¹For more information on SCLK and SCLK_V_{REF} on revision 0.0 silicon, see the EE-179: ADSP-TS20xS TigerSHARC System Design Guidelines on the Analog Devices website (www.analog.com).

STRAP PIN FUNCTION DESCRIPTIONS

Some pins have alternate functions at reset. Strap options set DSP operating modes. During reset, the DSP samples the strap option pins. Strap pins have an internal pullup or pulldown for the default value. If a strap pin is not connected to an overdriving external pullup, pulldown, or logic load, the DSP samples the default value during reset. If strap pins are connected to

logic inputs, a stronger external pullup or pulldown may be required to ensure default value depending on leakage and/or low level input current of the logic load. To set a mode other than the default mode, connect the strap pin to a sufficiently stronger external pullup or pulldown. Table 15 lists and describes each of the DSP's strap pins.

Table 15. Pin Definitions—I/O Strap Pins

| Signal | Type (at Reset) | On Pin... | Description |
|-------------|-----------------|-------------------------|-------------------------------------------------------------------------------------------------------------------------------------------------------------------------------------------------------------------------------|
| EBOOT | I (pd_0) | $\overline{\text{BMS}}$ | EPROM boot. 0 = boot from EPROM immediately after reset (default) 1 = idle after reset and wait for an external device to boot DSP through the external port or a link port |
| IRQEN | I (pd) | $\overline{\text{BM}}$ | Interrupt Enable. 0 = disable and set $\overline{\text{IRQ3-0}}$ interrupts to level-sensitive after reset (default) 1 = enable and set $\overline{\text{IRQ3-0}}$ interrupts to edge-sensitive immediately after reset |
| LINK_DWIDTH | I (pd) | TMR0E | Link Port Input Default Data Width. 0 = 1-bit (default) 1 = 4-bit |

I = input; A = asynchronous; O = output; OD = open drain output; T = Three-State; P = power supply; G = ground; **pd** = internal pulldown 5 kΩ; **pu** = internal pullup 5 kΩ; **pd_0** = internal pulldown 5 kΩ on DSP ID=0; **pu_0** = internal pullup 5 kΩ on DSP ID=0; **pu_od_0** = internal pullup 500Ω on DSP ID=0; **pd_m** = internal pulldown 5 kΩ on DSP bus master; **pu_m** = internal pullup 5 kΩ on DSP bus master; **pu_ad** = internal pullup 40 kΩ; For more pulldown and pullup information, see [Electrical Characteristics on page 21](#).

Table 15. Pin Definitions—I/O Strap Pins (Continued)

| Signal | Type (at Reset) | On Pin... | Description |
|------------|-----------------|-----------------------------|--------------------------------------------------------------------------------------------------------|
| SYS_REG_WE | I (pd_0) | $\overline{\text{BUSLOCK}}$ | SYSICON and SDRCON Write Enable. 0 = one-time writable after reset (default) 1 = always writable |
| TM1 | I (pu) | $\overline{\text{L1BCMPO}}$ | Test Mode 1. Do not overdrive default value during reset. |
| TM2 | I (pu) | $\overline{\text{L2BCMPO}}$ | Test Mode 2. Do not overdrive default value during reset. |
| TM3 | I (pu) | $\overline{\text{L3BCMPO}}$ | Test Mode 3. Do not overdrive default value during reset. |

I = input; A = asynchronous; O = output; OD = open drain output; T = Three-State; P = power supply; G = ground;
pd = internal pulldown 5 kΩ; **pu** = internal pullup 5 kΩ; **pd_0** = internal pulldown 5 kΩ on DSP ID=0; **pu_0** = internal pullup 5 kΩ on DSP ID=0; **pu_od_0** = internal pullup 500Ω on DSP ID=0; **pd_m** = internal pulldown 5 kΩ on DSP bus master; **pu_m** = internal pullup 5 kΩ on DSP bus master; **pu_ad** = internal pullup 40 kΩ; For more pulldown and pullup information, see [Electrical Characteristics on page 21](#).

When default configuration is used, no external resistor is needed on the strap pins. To apply other configurations, a 500Ω resistor connected to V_{DD_IO} is required. If providing external pulldowns, do not strap these pins directly to V_{SS}; the strap pins require 500Ω resistor straps.

All strap pins are sampled on the rising edge of $\overline{\text{RST_IN}}$ (deassertion edge). Each pin latches the strapped pin state (state of the strap pin at the rising edge of $\overline{\text{RST_IN}}$). Shortly after deassertion of $\overline{\text{RST_IN}}$, these pins are re-configured to their normal functionality.

These strap pins have an internal pull-down resistor, pull-up resistor, or no-resistor (three-state) on each pin. The resistor type, which is connected to the I/O pad, depends on whether $\overline{\text{RST_IN}}$ is active (low) or if $\overline{\text{RST_IN}}$ is de-asserted (high).

Table 16 shows the resistors that are enabled during active reset and during normal operation

Table 16. Strap Pin Internal Resistors—Active Reset ($\overline{\text{RST_IN}} = 0$) Versus Normal Operation ($\overline{\text{RST_IN}} = 1$)

| PIN | $\overline{\text{RST_IN}} = 0$ | $\overline{\text{RST_IN}} = 1$ |
|-----------------------------|---------------------------------|---------------------------------|
| BMS | (pd_0) | (pu_0) |
| BM | (pd) | Driven |
| TMROE | (pd) | Driven |
| $\overline{\text{BUSLOCK}}$ | (pd_0) | (pu_0) |
| $\overline{\text{L1BCMPO}}$ | (pu) | Driven |
| $\overline{\text{L2BCMPO}}$ | (pu) | Driven |
| $\overline{\text{L3BCMPO}}$ | (pu) | Driven |

pd = internal pulldown 5 kΩ; **pu** = internal pullup 5 kΩ; **pd_0** = internal pulldown 5 kΩ on DSP ID=0; **pu_0** = internal pullup 5 kΩ on DSP ID=0

ADSP-TS202S—SPECIFICATIONS

Note that component specifications are subject to change without notice. For information on Link port electrical

characteristics, see [Link Port Low-Voltage, Differential-Signal \(LVDS\) Electrical Characteristics and Timing on page 27](#).

RECOMMENDED OPERATING CONDITIONS

| Parameter | Test Conditions | Min | Typ | Max | Unit |
|-----------------------|--------------------------------------------------------------------------------------------------------|---------------------------------------------------------------------------------|------------------------------------------|-------|------|
| V _{DD} | Internal Supply Voltage | 0.95 | | 1.05 | V |
| V _{DD_A} | Analog Supply Voltage | 0.95 | | 1.05 | V |
| V _{DD_IO} | I/O Supply Voltage | 2.38 | | 2.63 | V |
| V _{DD_DRAM} | Internal DRAM Supply Voltage | 1.425 | | 1.575 | V |
| T _{CASE} | Case Operating Temperature | -40 | | +85 | °C |
| V _{IH} | High-Level Input Voltage ¹ | @ V _{DD} , V _{DD_IO} = max | 1.7 | 3.63 | V |
| V _{IL} | Low-Level Input Voltage ¹ | @ V _{DD} , V _{DD_IO} = min | -0.5 | 0.8 | V |
| I _{DD} | V _{DD} supply current for typical activity ² | @ CCLK=500 MHz, V _{DD} =1.0 V, T _{CASE} =25°C | 2.39 | | A |
| I _{DD_A} | V _{DD_A} supply current for typical activity | @ CCLK=500 MHz, V _{DD} =1.0 V, T _{CASE} =25°C | 20 | 50 | mA |
| I _{DD_IO} | V _{DD_IO} supply current for typical activity ² (DRAM Internal Regulator Disabled) | @ SCLK=100 MHz, V _{DD_IO} =2.5 V, T _{CASE} =25°C, ENEDREG=0 | 0.16 | | A |
| I _{DD_DRAM} | V _{DD_DRAM} supply current for typical activity ² | @ CCLK=500 MHz, V _{DD_DRAM} =1.5 V, T _{CASE} =25°C, ENEDREG=0 | 0.40 | | A |
| V _{REF} | Voltage reference | | (V _{DD_IO} × 0.56) ³ | | V |
| SCLK_V _{REF} | Voltage reference | | (V _{DD_IO} × 0.56) ³ | | V |

¹ Applies to input and bidirectional pins.

² For details on internal and external power calculation issues, see the *EE-170, Estimating Power for the ADSP-TS201S* on the Analog Devices website.

³ If the clock driver voltage is > 2.8 V and the clock driver voltage is used to generate SCLK_V_{REF}, this formula becomes: (V_{CLOCK_DRIVE}/2) ±5%

ELECTRICAL CHARACTERISTICS

| Parameter | Test Conditions | Min | Max | Unit |
|------------------------|----------------------------------------|--------------------------------------------------------------------------|------|------|
| V _{OH} | High-Level Output Voltage ¹ | @V _{DD_IO} = min, I _{OH} = -2 mA | 2.18 | V |
| V _{OL} | Low-Level Output Voltage ¹ | @V _{DD_IO} = min, I _{OL} = 4 mA | | 0.4 |
| I _{IH} | High-Level Input Current | @V _{DD_IO} = max, V _{IN} = V _{DD_IO} max | | 10 |
| I _{IH_PU} | High-Level Input Current | @V _{DD_IO} = max, V _{IN} = V _{DD_IO} max | | 50 |
| I _{IH_PD} | High-Level Input Current | @V _{DD_IO} = max, V _{IN} = V _{DD_IO} max | 0.3 | 0.76 |
| I _{IL} | Low-Level Input Current | @V _{DD_IO} = max, V _{IN} = 0V | | 10 |
| I _{IL_PU} | Low-Level Input Current | @V _{DD_IO} = max, V _{IN} = 0V | 0.3 | 0.76 |
| I _{IL_PU_AD} | Low-Level Input Current | @V _{DD_IO} = max, V _{IN} = 0V | 0.03 | 0.1 |
| I _{OZH} | Three-State Leakage Current High | @V _{DD_IO} = max, V _{IN} = V _{DD_IO} max | | 10 |
| I _{OZH_PD} | Three-State Leakage Current High | @V _{DD_IO} = max, V _{IN} = V _{DD_IO} max | 0.3 | 0.76 |
| I _{OZL} | Three-State Leakage Current Low | @V _{DD_IO} = max, V _{IN} = 0V | | 10 |
| I _{OZL_PU} | Three-State Leakage Current Low | @V _{DD_IO} = max, V _{IN} = 0 | 0.3 | 0.76 |
| I _{OZL_PU_AD} | Three-State Leakage Current Low | @V _{DD_IO} = max, V _{IN} = 0 | 0.03 | 0.1 |
| I _{OZL_OD} | Three-State Leakage Current Low | @V _{DD_IO} = max, V _{IN} = 0V | 4 | 7.6 |
| C _{IN} | Input Capacitance ^{2,3} | @f _{IN} = 1MHz, T _{CASE} = 25C, V _{IN} = 2.5V | | 3 |

Parameter name suffix conventions: no suffix = applies to pins without pullup or pull down resistors, **_PD** = applies to pin types (pd) or (pd_0), **_PU** = applies to pin types (pu) or (pu_0), **_PU_AD** = applies to pin types (pu_ad), **_OD** = applies to pin types OD

¹ Applies to output and bidirectional pins.

² Applies to all signals.

³ Guaranteed but not tested.

ABSOLUTE MAXIMUM RATINGS

| | |
|----------------------------------------------------------------|--------------------------------|
| Internal (Core) Supply Voltage (V_{DD}) ¹ | -0.3 V to +1.40 V |
| Analog (PLL) Supply Voltage (V_{DD_A}) ¹ | -0.3 V to +1.40 V |
| External (I/O) Supply Voltage (V_{DD_IO}) ¹ | -0.3 V to +3.5 V |
| External (DRAM) Supply Voltage (V_{DD_DRAM}) ¹ | -0.3 V to +2.1 V |
| Input Voltage ¹ | -0.5 V to 3.63 V |
| Output Voltage Swing ¹ | -0.5 V to $V_{DD_IO} + 0.5$ V |
| Storage Temperature Range ¹ | -65°C to +150°C |

¹Stresses greater than those listed above may cause permanent damage to the device. These are stress ratings only. Functional operation of the device at these or any other conditions greater than those indicated in the operational sections of this specification is not implied. Exposure to absolute maximum rating conditions for extended periods may affect device reliability.

ESD SENSITIVITY**CAUTION**

ESD (electrostatic discharge) sensitive device. Electrostatic charges as high as 4000V readily accumulate on the human body and test equipment and can discharge without detection. Although the ADSP-TS202S features proprietary ESD protection circuitry, permanent damage may occur on devices subjected to high-energy electrostatic discharges. Therefore, proper ESD precautions are recommended to avoid performance degradation or loss of functionality.



TIMING SPECIFICATIONS

With the exception of $\overline{\text{DMAR3-0}}$, $\overline{\text{IRQ3-0}}$, TMR0E, and FLAG3-0 (input only) pins, all AC timing for the ADSP-TS202S processor is relative to a reference clock edge. Because input setup/hold, output valid/hold, and output enable/disable times are relative to a clock edge, the timing data for the ADSP-TS202S processor has few calculated (formula-based) values. For information on AC timing, see [General AC Timing on page 23](#). For information on Link port transfer timing, see [Link Port Low-Voltage, Differential-Signal \(LVDS\) Electrical Characteristics and Timing on page 27](#).

General AC Timing

Timing is measured on signals when they cross the 1.25 V level as described in [Figure 11 on page 26](#). All delays (in nanoseconds) are measured between the point that the first signal reaches 1.25 V and the point that the second signal reaches 1.25 V.

The general AC timing data appears in [Table 18](#) and [Table 22](#). The AC asynchronous timing data for the $\overline{\text{IRQ3-0}}$, $\overline{\text{DMAR3-0}}$, FLAG3-0, and TMR0E pins appears in [Table 17](#).

Table 17. AC Asynchronous Signal Specifications (all values in this table are in nanoseconds)

| Name | Description | Pulsewidth Low (min) | Pulsewidth High (min) |
|-------------------------------|-------------------|-------------------------------|-------------------------------|
| $\overline{\text{IRQ3-0}}^1$ | Interrupt Request | $2 \times t_{\text{SCLK}}$ ns | $2 \times t_{\text{SCLK}}$ ns |
| $\overline{\text{DMAR3-0}}^1$ | DMA Request | $2 \times t_{\text{SCLK}}$ ns | $2 \times t_{\text{SCLK}}$ ns |
| FLAG3-0 ² | FLAG3-0 Input | $2 \times t_{\text{SCLK}}$ ns | $2 \times t_{\text{SCLK}}$ ns |
| TMR0E ³ | Timer 0 Expired | $4 \times t_{\text{SCLK}}$ ns | – |

¹ These input pins have Schmitt triggers and therefore do not need to be synchronized to a clock reference.
² For output specifications on FLAG3-0 pins, see [Table 22](#).
³ This pin is a strap option. During reset, an internal resistor pulls the pin low.

Table 18. Reference Clocks

| Signal | Type | Description | Speed Grade (MHz) | Clock Cycle Min (ns) | Clock Cycle Max (ns) | Clock High Min (ns) | Clock Low Min (ns) | Input Jitter Tolerance (ps) |
|-----------------------|------|-------------------|-------------------|-------------------------|----------------------|-------------------------|--------------------|-----------------------------|
| CCLK ¹ | – | Core Clock | 500 | 2.0 | 12.5 | – | – | – |
| SCLK ^{2,3,4} | I | System Clock | All | Greater of 8 or CCLKx4 | 50 | {40% to 60% Duty Cycle} | | 100 |
| TCK | I | Test Clock (JTAG) | All | Greater of 30 or CCLKx4 | – | 12 | 12 | – |

¹ CCLK is the internal DSP clock or instruction cycle time. The period of this clock is equal to the System Clock (SCLK) period divided by the System Clock Ratio (SCLKRAT2-0). For information on available internal DSP clock rates, see the [Ordering Guide on page 40](#).
² Actual input jitter should be combined with ac specifications for accurate timing analysis.
³ For more information, see [Table 3 on page 12](#).
⁴ For more information, see [Clock Domains on page 9](#).

Table 19. Power-Up Reset Timing

| Parameter | Min | Max | Units |
|------------------------------|-----|-----|-------|
| <i>Timing Requirements</i> | | | |
| $t_{\text{VDD_DRAM}}^1$ | 0 | | ms |
| $t_{\text{VDD_DRAM_RAMP}}$ | | 0.2 | ms |

¹ Applies only when the internal DRAM regulator is disabled (ENEDREG=0)

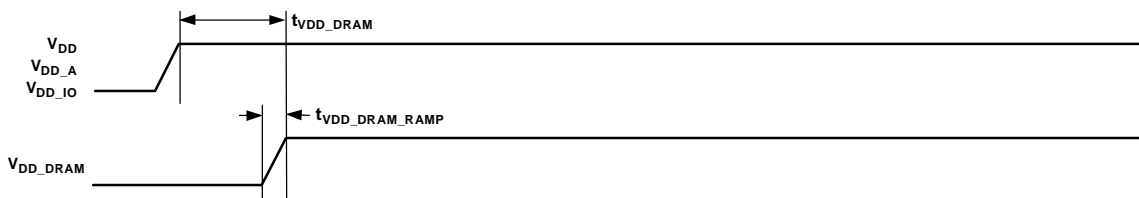

Figure 8. Power-Up Timing

Table 20. Power-Up Reset Timing

| Parameter | Min | Max | Units |
|---------------------------------|--------------------------------------------------------------------------------------------------------------------------------|-----|-------|
| <i>Timing Requirements</i> | | | |
| $t_{RST_IN_PWR}$ | RST_IN Deasserted After V_{DD} , V_{DD_A} , V_{DD_IO} , V_{DD_DRAM} (ENEDREG=0), SCLK, and Static/Strap Pins Stable | | ms |
| $t_{TRST_IN_PWR}^1$ | TRST Asserted During Power-Up Reset | | ns |
| <i>Switching Characteristic</i> | | | |
| $t_{RST_OUT_PWR}$ | RST_OUT Deasserted After RST_IN Deasserted | | ms |

¹ Applies after V_{DD} , V_{DD_A} , V_{DD_IO} , V_{DD_DRAM} (ENEDREG=0), and SCLK are stable and before RST_IN deasserted.

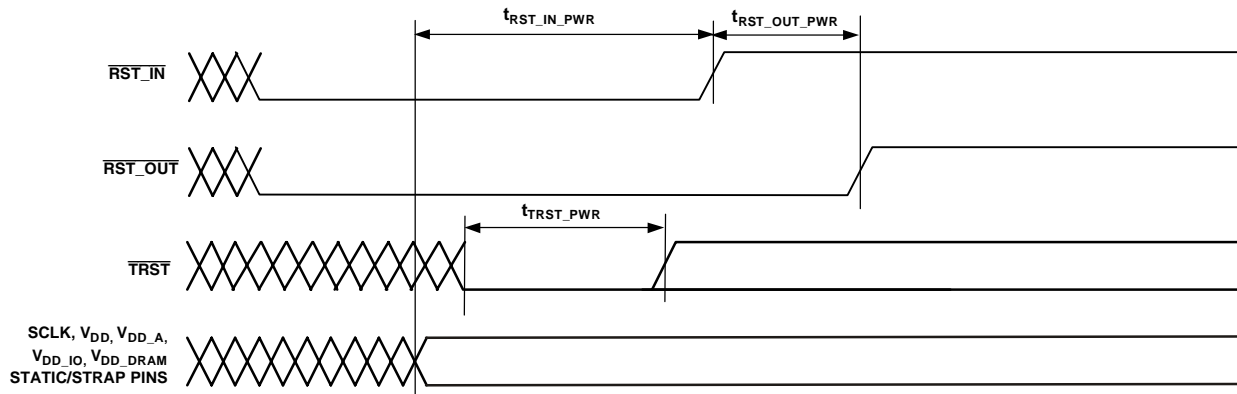

Figure 9. Power-Up Reset Timing

Table 21. Normal Reset Timing

| Parameter | Min | Max | Units |
|---------------------------------|--------------------------------------------|-----|-------|
| <i>Timing Requirements</i> | | | |
| t_{RST_IN} | RST_IN Asserted | | ms |
| t_{STRAP} | RST_IN Deasserted After Strap Pins Stable | | ms |
| <i>Switching Characteristic</i> | | | |
| t_{RST_OUT} | RST_OUT Deasserted After RST_IN Deasserted | | ms |

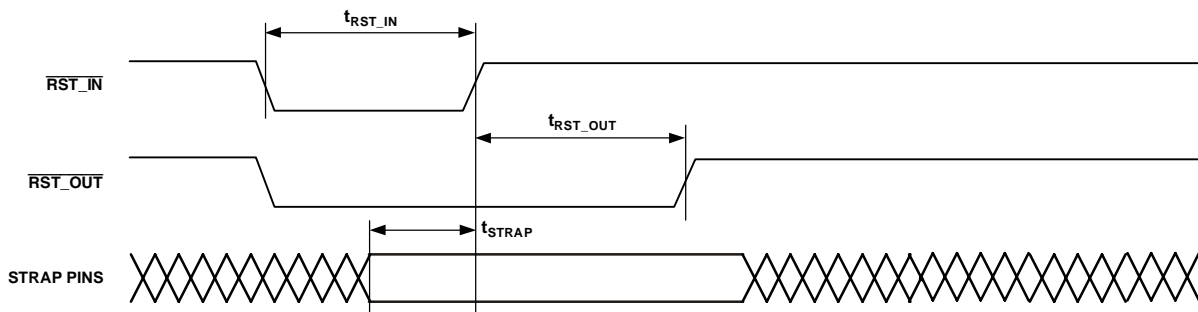

Figure 10. Normal Reset Timing

Table 22. AC Signal Specifications

(all values in this table are in nanoseconds)

| Name | Description | Input Setup (min) | Input Hold (min) | Output Valid (max) | Output Hold (min) | Output Enable (min) ¹ | Output Disable (max) ¹ | Reference Clock |
|---------------------------------------|----------------------------------|----------------------|---------------------|-----------------------|----------------------|-------------------------------------|--------------------------------------|--------------------|
| ADDR31–0 | External Address Bus | 1.5 | 0.5 | 4.0 | 1.0 | 1.15 | 2.0 | SCLK |
| DATA63–0 | External Data Bus | 1.5 | 0.5 | 4.0 | 1.0 | 1.15 | 2.0 | SCLK |
| $\overline{\text{MSH}}$ | Memory Select HOST Line | — | — | 4.0 | 1.0 | 1.15 | 2.0 | SCLK |
| $\overline{\text{MSSD3}}\text{--}0$ | Memory Select SDRAM Lines | 1.5 | 0.5 | 4.0 | 1.0 | 1.15 | 2.0 | SCLK |
| $\overline{\text{MS1}}\text{--}0$ | Memory Select for Static Blocks | — | — | 4.0 | 1.0 | 1.15 | 2.0 | SCLK |
| $\overline{\text{RD}}$ | Memory Read | 1.5 | 0.5 | 4.0 | 1.0 | 1.15 | 2.0 | SCLK |
| $\overline{\text{WRL}}$ | Write Low Word | 1.5 | 0.5 | 4.0 | 1.0 | 1.15 | 2.0 | SCLK |
| $\overline{\text{WRH}}$ | Write High Word | 1.5 | 0.5 | 4.0 | 1.0 | 1.15 | 2.0 | SCLK |
| ACK | Acknowledge for Data Hi to Low | 1.5 | 0.5 | 3.6 | 2.0 | 1.15 | 2.0 | SCLK |
| | Acknowledge for Data Low to High | 1.5 | 0.5 | 4.2 | 2.0 | 1.15 | 2.0 | SCLK |
| SDCKE | SDRAM Clock Enable | 1.5 | 0.5 | 4.0 | 1.0 | 1.15 | 2.0 | SCLK |
| $\overline{\text{RAS}}$ | Row Address Select | 1.5 | 0.5 | 4.0 | 1.0 | 1.15 | 2.0 | SCLK |
| $\overline{\text{CAS}}$ | Column Address Select | 1.5 | 0.5 | 4.0 | 1.0 | 1.15 | 2.0 | SCLK |
| $\overline{\text{SDWE}}$ | SDRAM Write Enable | 1.5 | 0.5 | 4.0 | 1.0 | 1.15 | 2.0 | SCLK |
| LDQM | Low Word SDRAM Data Mask | — | — | 4.0 | 1.0 | 1.15 | 2.0 | SCLK |
| HDQM | High Word SDRAM Data Mask | — | — | 4.0 | 1.0 | 1.15 | 2.0 | SCLK |
| SDA10 | SDRAM ADDR10 | — | — | 4.0 | 1.0 | 1.15 | 2.0 | SCLK |
| $\overline{\text{HBR}}$ | Host Bus Request | 1.5 | 0.5 | — | — | — | — | SCLK |
| $\overline{\text{HBG}}$ | Host Bus Grant | 1.5 | 0.5 | 4.0 | 1.0 | 1.15 | 2.0 | SCLK |
| $\overline{\text{BOFF}}$ | Back Off Request | 1.5 | 0.5 | — | — | — | — | SCLK |
| $\overline{\text{BUSLOCK}}$ | Bus Lock | — | — | 4.0 | 1.0 | 1.15 | 2.0 | SCLK |
| $\overline{\text{BRST}}$ | Burst pin | 1.5 | 0.5 | 4.0 | 1.0 | 1.15 | 2.0 | SCLK |
| $\overline{\text{BR7}}\text{--}0$ | Multiprocessing Bus Request pins | 1.5 | 0.5 | 4.0 | 1.0 | — | — | SCLK |
| $\overline{\text{BM}}$ | Bus Master Debug aid only | — | — | 4.0 | 1.0 | — | — | SCLK |
| $\overline{\text{IORD}}$ | I/O Read pin | — | — | 4.0 | 1.0 | 1.15 | 2.0 | SCLK |
| $\overline{\text{IOWR}}$ | I/O Write pin | — | — | 4.0 | 1.0 | 1.15 | 2.0 | SCLK |
| $\overline{\text{IOEN}}$ | I/O Enable pin | — | — | 4.0 | 1.0 | 1.15 | 2.0 | SCLK |
| $\overline{\text{CPA}}$ | Core Priority Access Hi to Low | 1.5 | 0.5 | 4.0 | 1.0 | 1.15 | 2.0 | SCLK |
| | Core Priority Access Low to Hi | 1.5 | 0.5 | 23.5 | 2.0 | 1.15 | 2.0 | SCLK |
| $\overline{\text{DPA}}$ | DMA Priority Access Hi to Low | 1.5 | 0.5 | 4.0 | 1.0 | 1.15 | 2.0 | SCLK |
| | DMA Priority Access Low to Hi | 1.5 | 0.5 | 23.5 | 2.0 | 1.15 | 2.0 | SCLK |
| $\overline{\text{BMS}}$ | Boot Memory Select | 1.5 | 0.5 | 4.0 | 1.0 | 1.15 | 2.0 | SCLK |
| FLAG3–0 ² | FLAG pins | — | — | 4.0 | 1.0 | 1.15 | 2.0 | SCLK |
| $\overline{\text{RST_IN}}\text{3,4}$ | Global Reset pin | 1.5 | 0.5 | — | — | — | — | SCLK |
| TMS | Test Mode Select (JTAG) | 1.5 | 0.5 | — | — | — | — | TCK |
| TDI | Test Data Input (JTAG) | 1.5 | 0.5 | — | — | — | — | TCK |
| TDO | Test Data Output (JTAG) | — | — | 4.0 | 1.0 | 1.15 | 2.0 | TCK |
| $\overline{\text{TRST}}\text{3,4}$ | Test Reset (JTAG) | 1.5 | 0.5 | — | — | — | — | TCK |
| $\overline{\text{EMU}}\text{5}$ | Emulation High to Low | — | — | 3.6 | 2.0 | 1.15 | 2.0 | TCK or SCLK |
| ID2–0 ⁶ | Static pins – must be constant | — | — | — | — | — | — | — |
| CONTROLIMP1–0 ⁶ | Static pins – must be constant | — | — | — | — | — | — | — |

Table 22. AC Signal Specifications (Continued)

(all values in this table are in nanoseconds)

| Name | Description | Input Setup (min) | Input Hold (min) | Output Valid (max) | Output Hold (min) | Output Enable (min) ¹ | Output Disable (max) ¹ | Reference Clock |
|--------------------------|----------------------------------------------------|-------------------|------------------|--------------------|-------------------|----------------------------------|-----------------------------------|-----------------|
| DS2-0 ⁶ | Static pins – must be constant | — | — | — | — | — | — | — |
| SCLKRAT2-0 ⁶ | Static pins – must be constant | — | — | — | — | — | — | — |
| ENEDREG ⁶ | Static pins – must be connected to V _{SS} | — | — | — | — | — | — | — |
| STRAP SYS ^{7,8} | Strap pins | 1.5 | 0.5 | — | — | — | — | SCLK |
| JTAG SYS ⁹ | JTAG system pins | 1.5 | 0.5 | 4.0 | 1.0 | — | — | TCK |

¹ The external port protocols employ bus IDLE cycles for bus mastership transitions as well as slave address boundary crossings to avoid any potential bus contention. The apparent driver overlap, due to output disables being larger than output enables, is not actual.

² For input specifications on FLAG3-0 pins, see Table 17.

³ These input pins are asynchronous and therefore do not need to be synchronized to a clock reference.

⁴ For additional requirement details, see Reset and Booting on page 9.

⁵ Reference clock depends on function.

⁶ These pins may change only during reset; recommend connecting it to V_{DD10}/V_{SS}.

⁷ STRAP pins include: BMS, BM, BUSLOCK, TMR0E, L1BCMPO, L2BCMPO, and L3BCMPO.

⁸ Specifications applicable during reset only.

⁹ JTAG system pins include: RST_IN, RST_OUT, POR_IN, IRQ3-0, DMAR3-0, HBR, BOFF, MS1-0, MSH, SDCKE, LDQM, HDQM, BMS, TOWR, IORD, BM, EMU, SDA10, IOEN, BUSLOCK, TMR0E, DATA63-0, ADDR31-0, RD, WR, WRH, BRST, MSSD3-0, RAS, CAS, SDWE, HBG, BR7-0, FLAG3-0, L0DATOP3-0, L0DATON3-0, L1DATOP3-0, L1DATON3-0, L2DATOP3-0, L2DATON3-0, L3DATOP3-0, L3DATON3-0, L0CLKOUTP, L0CLKOUTN, L1CLKOUTP, L1CLKOUTN, L2CLKOUTP, L2CLKOUTN, L3CLKOUTP, L3CLKOUTN, L0ACKI, L1ACKI, L2ACKI, L3ACKI, L0DATIP3-0, L0DATIN3-0, L1DATIP3-0, L1DATIN3-0, L2DATIP3-0, L2DATIN3-0, L3DATIP3-0, L3DATIN3-0, L0CLKINP, L0CLKINN, L1CLKINP, L1CLKINN, L2CLKINP, L2CLKINN, L3CLKINP, L3CLKINN, L0ACKO, L1ACKO, L2ACKO, L3ACKO, ACK, CPA, DPA, L0BCMPO, L1BCMPO, L2BCMPO, L3BCMPO, L0BCMPI, L1BCMPI, L2BCMPI, L3BCMPI, ID2-0, CTRL_IMPDI-0, SCLKRAT2-0, DS2-0, ENEDREG.

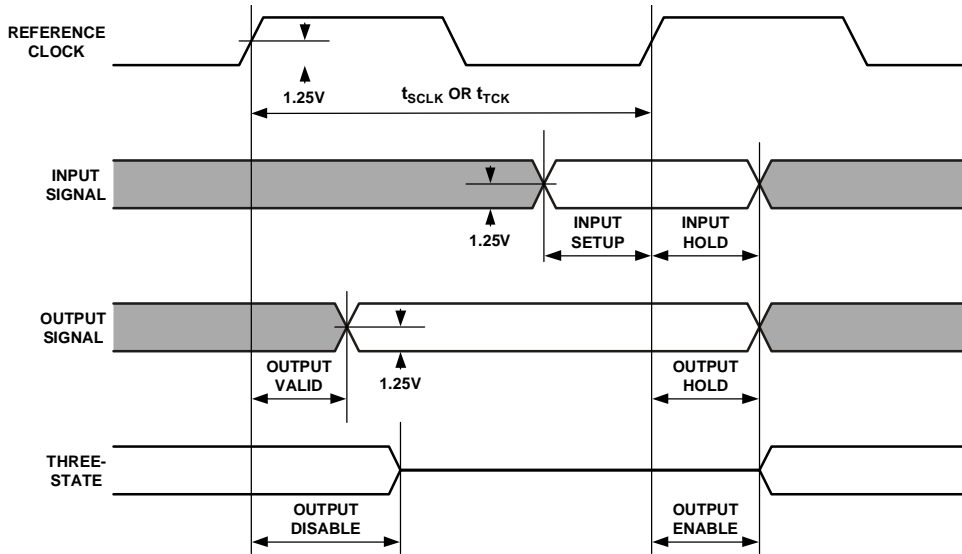

Figure 11. General AC Parameters Timing

**Link Port Low-Voltage, Differential-Signal (LVDS)
Electrical Characteristics and Timing**

Table 23 and Table 24 with Figure 12 provide the electrical characteristics for the LVDS link ports. The LVDS link port signal definitions represent all differential signals with a $V_{OD} = 0$ V level and use signal naming without N (negative) and P (positive) suffixes (see Figure 12).

Table 23. Link Port LVDS Transmit Electrical Characteristics

| Parameter | Test Conditions | Min | Max | Units |
|------------|-----------------------------------------------|--------------------------------|--------|-------|
| V_{OH} | Output Voltage High, V_{O_P} or V_{O_N} | | 1.58 | V |
| V_{OL} | Output Voltage Low, V_{O_P} or V_{O_N} | 0.92 | | V |
| $ V_{OD} $ | Output Differential Voltage | 150 | 450 | mV |
| I_{OS} | Short-circuit Output Current | V_{O_P} or $V_{O_N} = 0$ V | +/- 40 | mA |
| V_{OCM} | Common Mode Output Voltage | $V_{OD} = 0$ V | +/- 5 | mA |
| | | 1.13 | 1.38 | V |

Table 24. Link Port LVDS Receive Electrical Characteristics

| Parameter | Test Conditions | Min | Max | Units |
|------------|----------------------------|-----|------|-------|
| $ V_{ID} $ | Differential Input Voltage | 100 | 600 | mV |
| V_{ICM} | Common Mode Input Voltage | 0.6 | 1.57 | V |

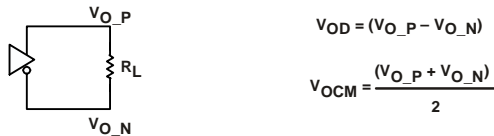

Figure 12. Link Ports—Transmit Electrical Characteristics

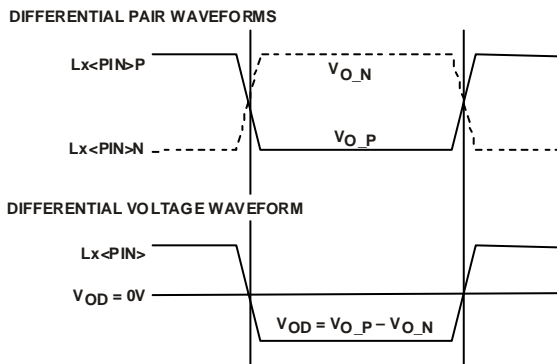

Figure 13. Link Ports—Signals Definition

Link Port—Data Out Timing

Table 25 with Figure 14, Figure 15, Figure 16, Figure 17, Figure 18, and Figure 19 provide the data out timing for the LVDS link ports.

Table 25. Link Port—Data Out Timing

| Parameter | | Min | Max | Units |
|----------------|------------------------------------------------------------------------------------------------------------------------------------------------------------------------------------------------------------|------------------------------------------------------------------------|----------------------------------------|-------|
| <i>Outputs</i> | | | | |
| t_{REO} | Rising Edge (Figure 14) | | 200 | ps |
| t_{FEO} | Falling Edge (Figure 14) | | 200 | ps |
| t_{LCLKOP} | LxCLKOUT Period (Figure 15) | greater of 2.0 or $0.9 \times LCR \times t_{CCLK}^{1,2}$ | $1.1 \times LCR \times t_{CCLK}^{1,2}$ | ns |
| t_{LCLKOH} | LxCLKOUT High (Figure 15) | $0.4 \times t_{LCLKOP}^1$ | $0.6 \times t_{LCLKOP}^1$ | ns |
| t_{LCLKOL} | LxCLKOUT Low (Figure 15) | $0.4 \times t_{LCLKOP}^1$ | $0.6 \times t_{LCLKOP}^1$ | ns |
| t_{COJT} | LxCLKOUT Jitter (Figure 15) | | -/+70 | ps |
| t_{LDOS} | LxDATO Output Setup, LCR = 1 and LCR = 1.5 (Figure 16) | smaller of 2.5^3 or $0.25 \times LCR \times t_{CCLK} - 0.15^{1,2,4}$ | | ns |
| | LxDATO Output Setup, LCR = 2 and LCR = 4 (Figure 16) | smaller of 2.5^3 or $0.25 \times LCR \times t_{CCLK} - 0.3^{1,2,4}$ | | ns |
| t_{LDOH} | LxDATO Output Hold, LCR = 1 and LCR = 1.5 (Figure 16) | $0.25 \times LCR \times t_{CCLK} - 0.15^{1,2,4}$ | | ns |
| | LxDATO Output Hold, LCR = 2 and LCR = 4 (Figure 16) | $0.25 \times LCR \times t_{CCLK} - 0.3^{1,2,4}$ | | ns |
| t_{LACKID} | Delay from LxACKI rising edge to first transmission clock edge (Figure 17) | | $14 \times LCR \times t_{CCLK}^{1,2}$ | ns |
| t_{BCMPOV} | $\overline{LxBCMPO}$ Valid (Figure 17) | | $2 \times LCR \times t_{CCLK}^{1,2}$ | ns |
| t_{BCMPOH} | $\overline{LxBCMPO}$ Hold (Figure 18). | $3 \times TSW - 0.5^{1,5}$ | | ns |
| <i>Inputs</i> | | | | |
| t_{LACKIS} | LxACKI low setup to guarantee that the transmitter stops transmitting (Figure 18). LxACKI high setup to guarantee that the transmitter continues its transmission without any interruption (Figure 19). | $14 \times LCR \times t_{CCLK}^{1,2}$ | | ns |
| t_{LACKIH} | LxACKI high hold time (Figure 18). | 0.5^1 | | ns |

¹ Timing is relative to the 0 differential voltage ($V_{OD} = 0$)

² LCR (Link port Clock Ratio) = 1, 1.5, 2 or 4. t_{CCLK} is the core period

³ The 2.5 value for t_{LDOS} applies for $LCLKOUT \leq 100$ MHz.

⁴ t_{LDOS} and t_{LDOH} values include LCLKOUT jitter.

⁵ TSW is a short-word transmission period. For a 4-Bit Link it is $2 \times LCR \times t_{CCLK}$ and for a 1-Bit Link is $8 \times LCR \times t_{CCLK}$ ns

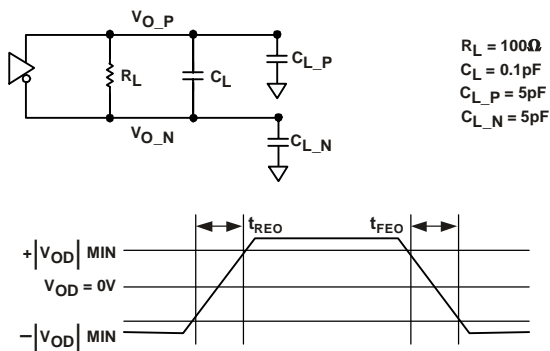

Figure 14. Link Ports—Differential Output Signals Transition Time

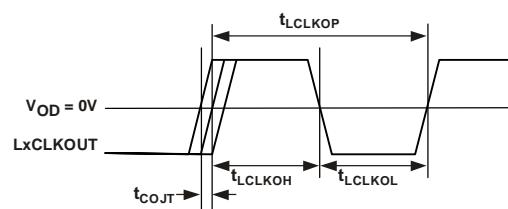

Figure 15. Link Ports—Output Clock

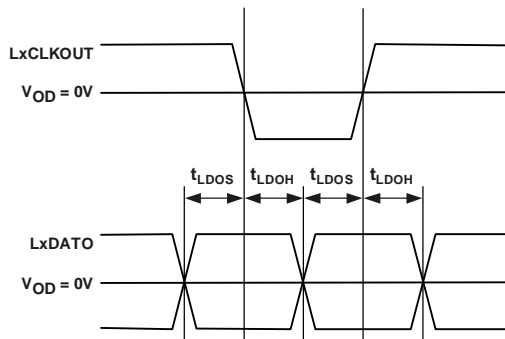

Figure 16. Link Ports—Data Output Setup and Hold¹

¹These parameters are valid for both clock edges

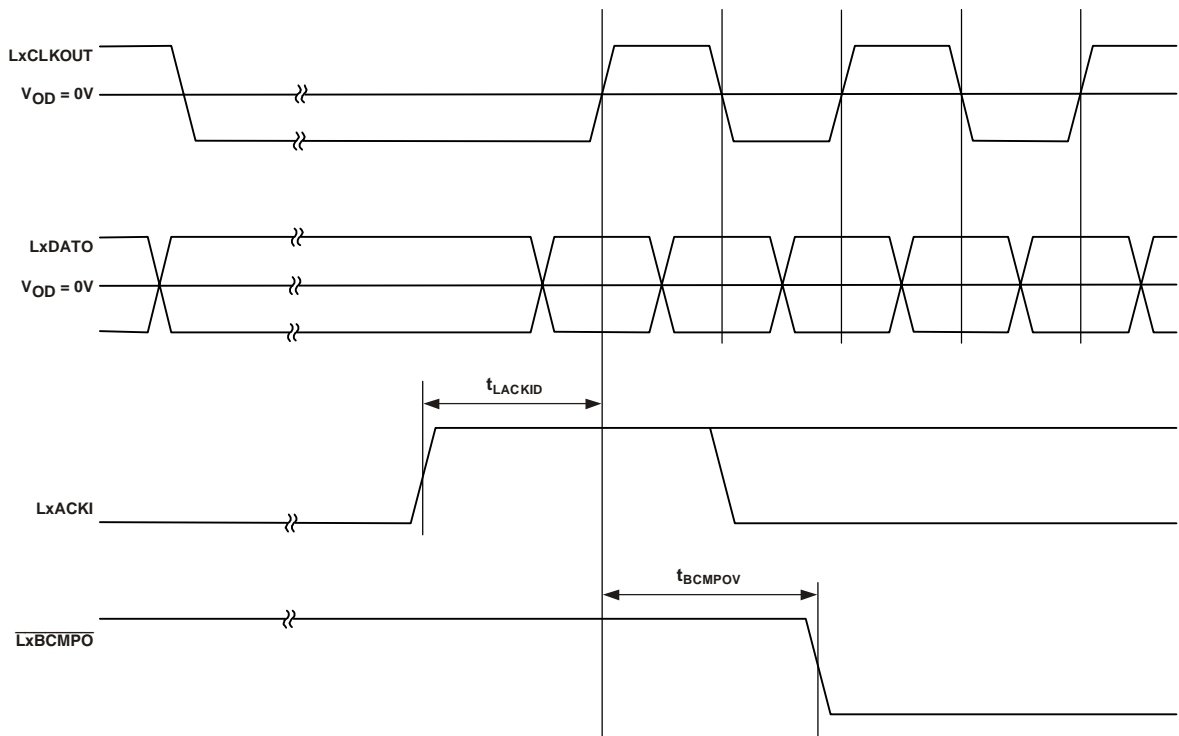

Figure 17. Link Ports—Transmission Start

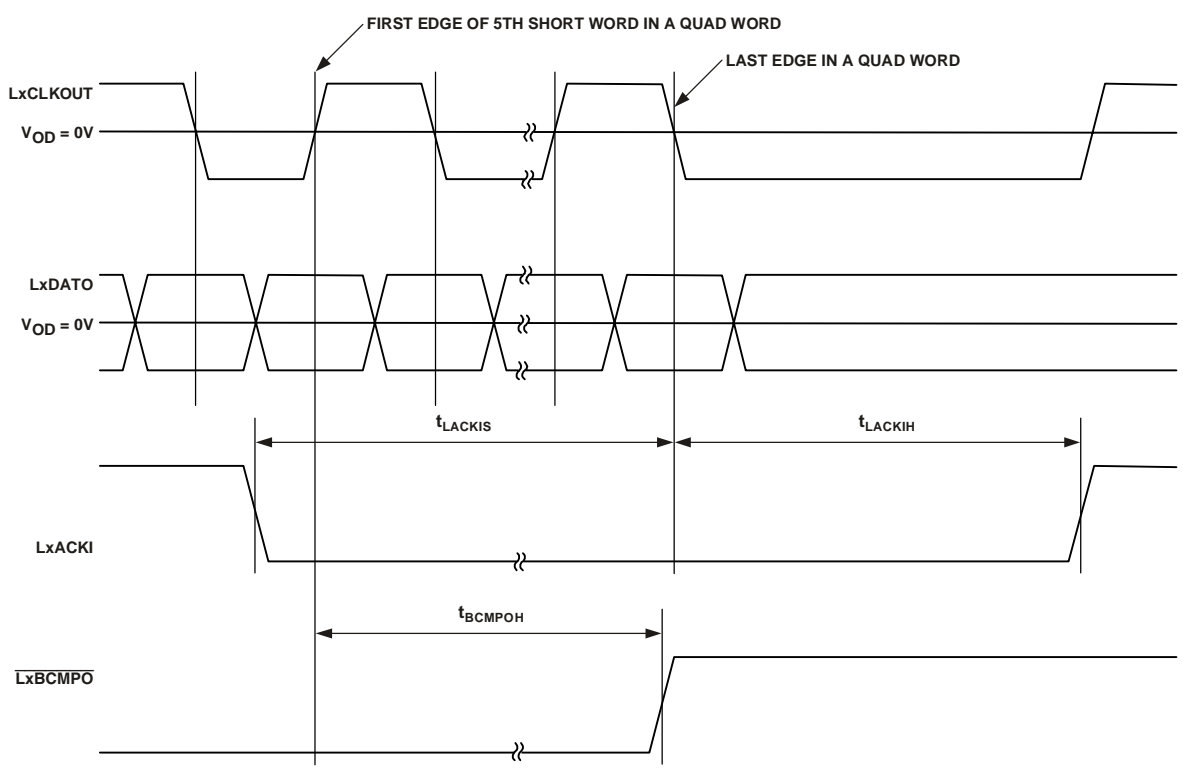

Figure 18. Link Ports—Transmission End and Stops

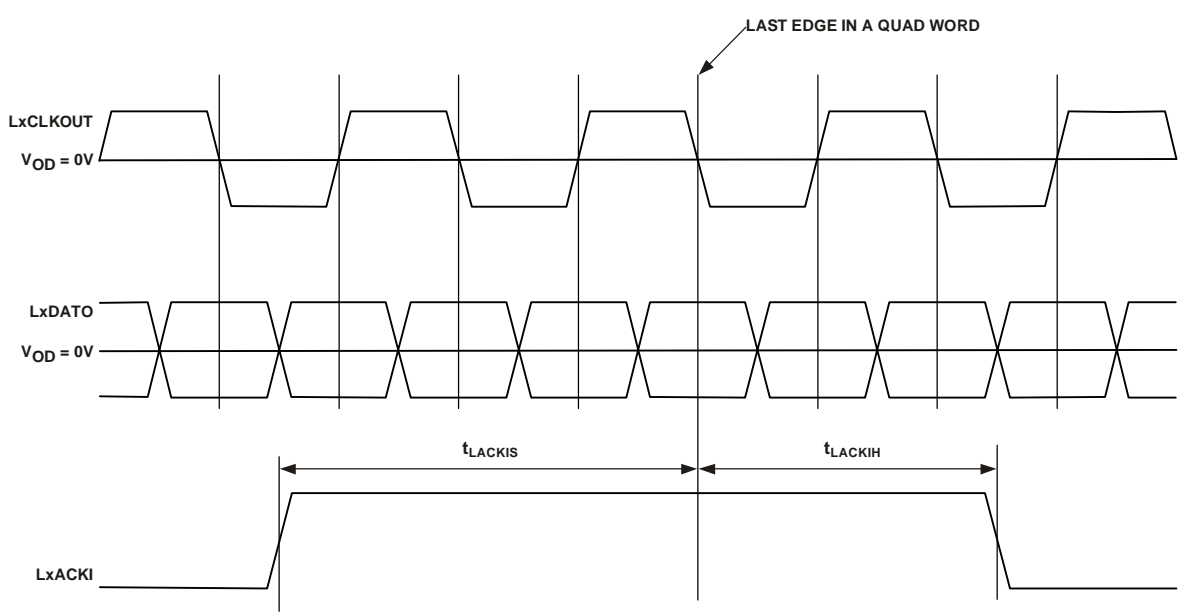

Figure 19. Link Ports—Back to Back Transmission

Link Port—Data In Timing

Table 26 with Figure 20, Figure 21, and Figure 22 provide the data in timing for the LVDS link ports.

Table 26. Link Port—Data In Timing

| Parameter | Min | Max | Units |
|---------------|--------------------------------|-----|-------|
| <i>Inputs</i> | | | |
| t_{LCLKIP} | LxCLKIN Period (Figure 22) | | ns |
| t_{REI} | Rising Edge (Figure 21) | 400 | ps |
| t_{FEI} | Falling Edge (Figure 21) | 400 | ps |
| t_{LDIS} | LxDATI Input Setup (Figure 22) | | ns |
| t_{LDIH} | LxDATI Input Hold (Figure 22) | | ns |
| t_{BCMPIS} | LxBCMPI Valid (Figure 20) | | ns |
| t_{BCMPIH} | LxBCMPI Hold (Figure 20) | | ns |

¹Timing is relative to the 0 differential voltage ($V_{OD} = 0$)

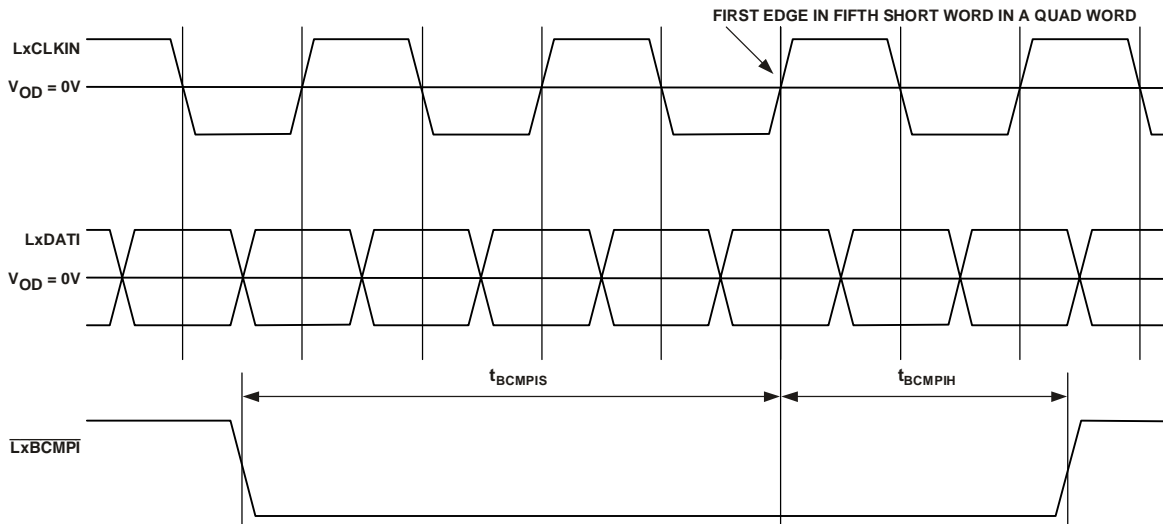

Figure 20. Link Ports—Last Received Quad Word

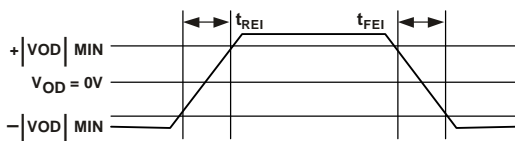

Figure 21. Link Ports—Differential Input Signals Transition Time

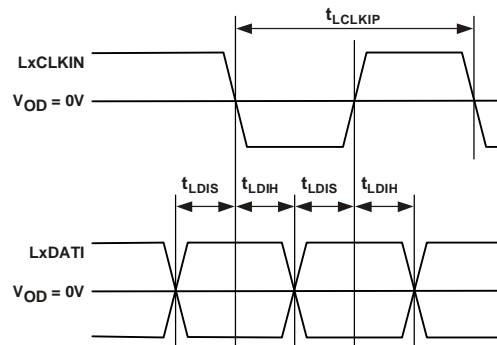

Figure 22. Link Ports—Data Input Setup and Hold¹

¹These parameters are valid for both clock edges

OUTPUT DRIVE CURRENTS

Figure 23 through Figure 30 show typical I-V characteristics for the output drivers of the ADSP-TS202S processor. The curves in these diagrams represent the current drive capability of the output drivers as a function of output voltage over the range of drive strengths. For complete output driver characteristics, refer to the DSP's IBIS models, available on the Analog Devices website (www.analog.com).

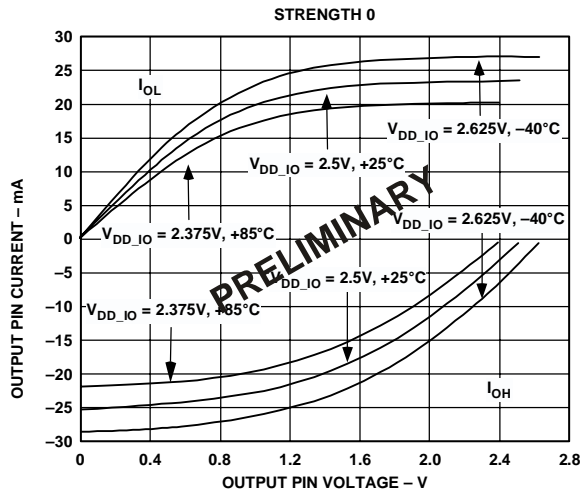

Figure 23. Typical Drive Currents at Strength 0

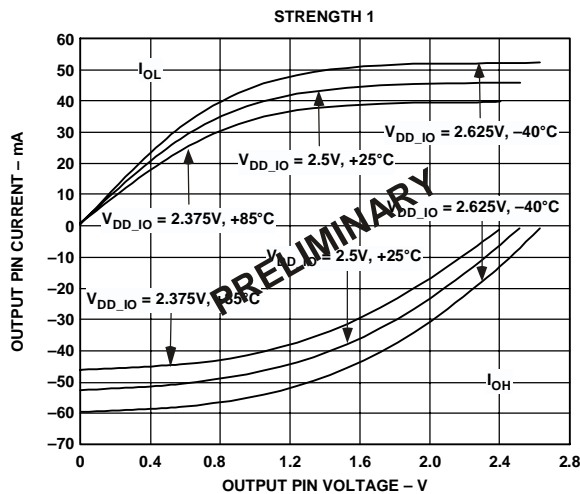

Figure 24. Typical Drive Currents at Strength 1

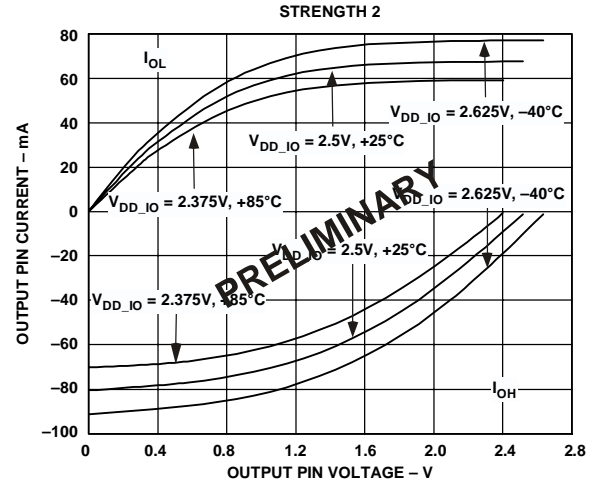

Figure 25. Typical Drive Currents at Strength 2

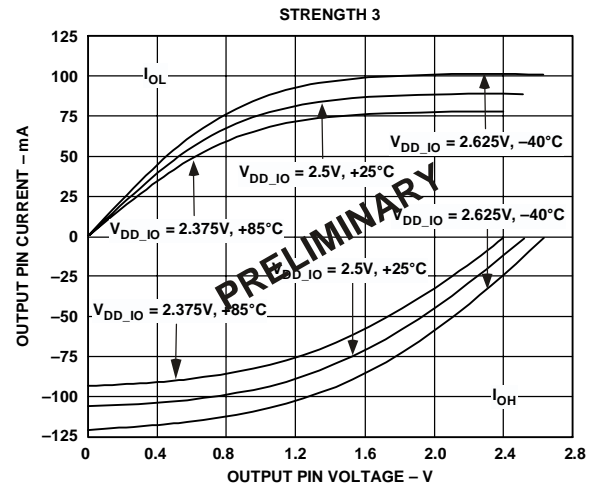

Figure 26. Typical Drive Currents at Strength 3

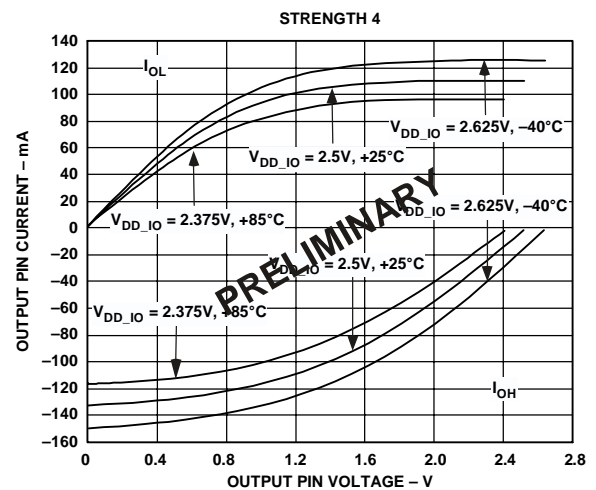

Figure 27. Typical Drive Currents at Strength 4

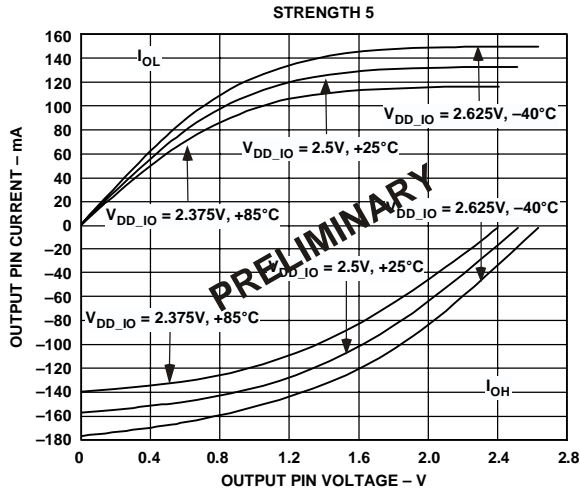

Figure 28. Typical Drive Currents at Strength 5

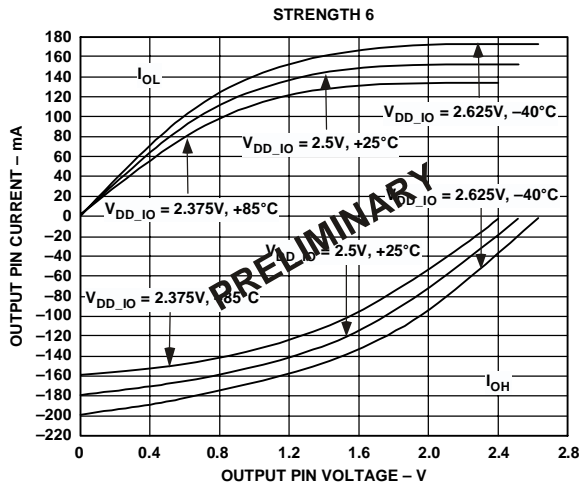

Figure 29. Typical Drive Currents at Strength 6

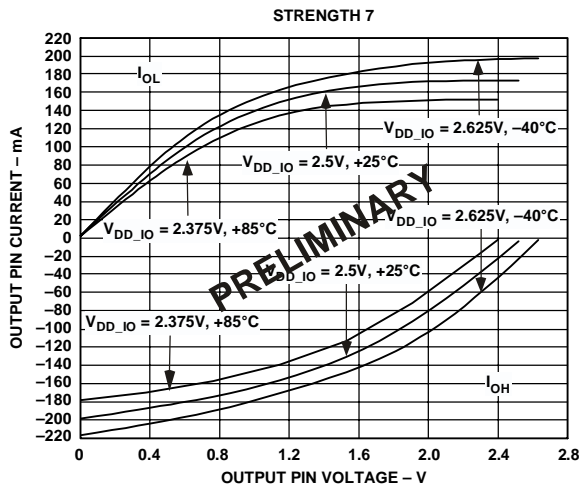

Figure 30. Typical Drive Currents at Strength 7

TEST CONDITIONS

The ac signal specifications (timing parameters) appear Table 22 on page 25. These include output disable time, output enable time, and capacitive loading. The timing specifications for the DSP apply for the voltage reference levels in Figure 31.

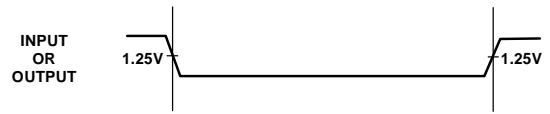

Figure 31. Voltage reference levels for AC measurements (except output enable/disable)

Output Disable Time

Output pins are considered to be disabled when they stop driving, go into a high impedance state, and start to decay from their output high or low voltage. The time for the voltage on the bus to decay by ΔV is dependent on the capacitive load, C_L and the load current, I_L . This decay time can be approximated by the following equation:

$$t_{DECAY} = (C_L \Delta V) / I_L$$

The output disable time t_{DIS} is the difference between $t_{MEASURED_DIS}$ and t_{DECAY} as shown in Figure 32. The time $t_{MEASURED_DIS}$ is the interval from when the reference signal switches to when the output voltage decays ΔV from the measured output high or output low voltage. t_{DECAY} is calculated with test loads C_L and I_L , and with ΔV equal to 0.4 V.

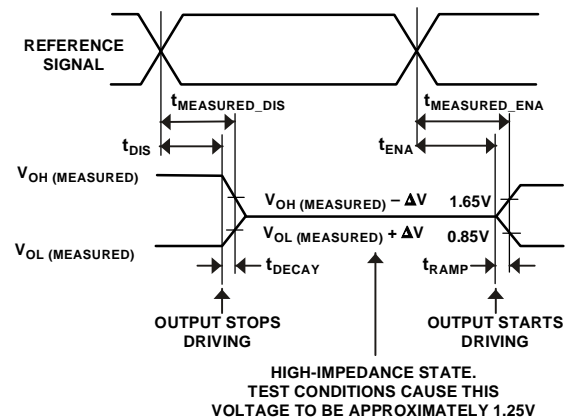

Figure 32. Output Enable/Disable

Output Enable Time

Output pins are considered to be enabled when they have made a transition from a high impedance state to when they start driving. The time for the voltage on the bus to ramp by ΔV is dependent on the capacitive load, C_L , and the drive current, I_D . This ramp time can be approximated by the following equation:

$$t_{RAMP} = (C_L \Delta V) / I_D$$

The output enable time t_{ENA} is the difference between $t_{MEASURED_ENA}$ and t_{RAMP} as shown in Figure 32. The time $t_{MEASURED_ENA}$ is the interval from when the reference signal switches to when the output voltage ramps ΔV from the measured three-stated output level. t_{RAMP} is calculated with test load C_L , drive current I_D , and with ΔV equal to 0.4 V.

Capacitive Loading

Output valid and hold are based on standard capacitive loads: 30 pF on all pins (see Figure 33). The delay and hold specifications given should be derated by a drive strength related factor for loads other than the nominal value of 30 pF. Figure 34 through Figure 41 show how output rise time varies with capacitance. Figure 42 graphically shows how output valid varies with load capacitance. (Note that this graph or derating does not apply to output disable delays; see Output Disable Time on page 33.) The graphs of Figure 34 through Figure 42 may not be linear outside the ranges shown.

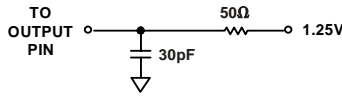

Figure 33. Equivalent Device Loading for AC Measurements (Includes All Fixtures)

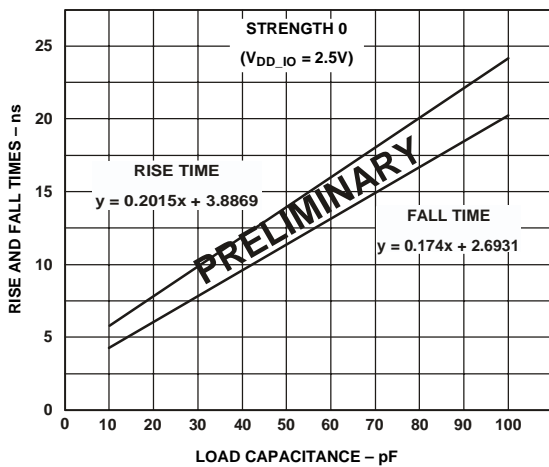

Figure 34. Typical Output Rise and Fall Time (10%–90%, $V_{DD_IO} = 2.5V$) vs. Load Capacitance at Strength 0

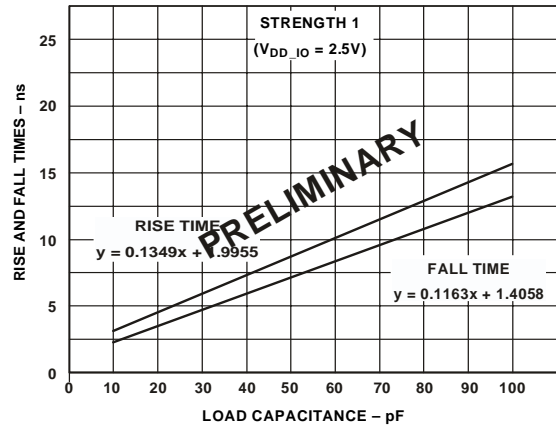

Figure 35. Typical Output Rise and Fall Time (10%–90%, $V_{DD_IO} = 2.5V$) vs. Load Capacitance at Strength 1

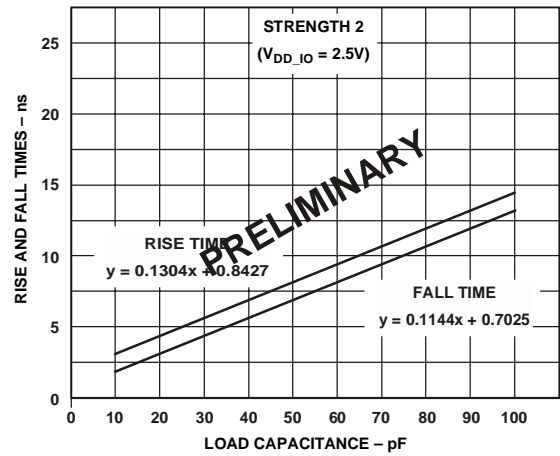

Figure 36. Typical Output Rise and Fall Time (10%–90%, $V_{DD_IO} = 2.5V$) vs. Load Capacitance at Strength 2

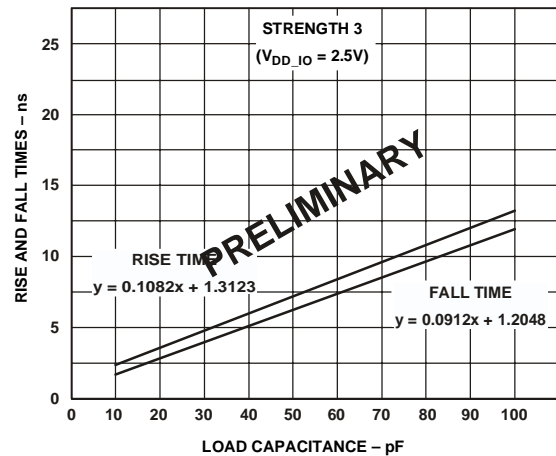

Figure 37. Typical Output Rise and Fall Time (10%–90%, $V_{DD_IO} = 2.5V$) vs. Load Capacitance at Strength 3

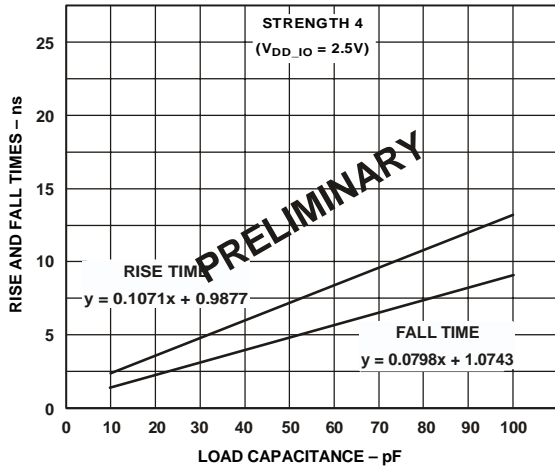

Figure 38. Typical Output Rise and Fall Time (10%–90%, $V_{DD_IO} = 2.5\text{ V}$) vs. Load Capacitance at Strength 4

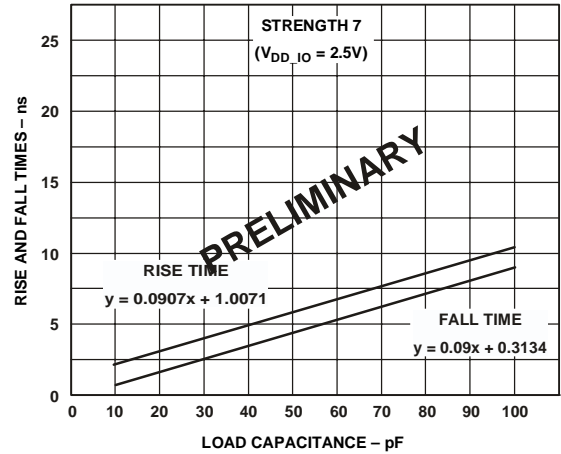

Figure 41. Typical Output Rise and Fall Time (10%–90%, $V_{DD_IO} = 2.5\text{ V}$) vs. Load Capacitance at Strength 7

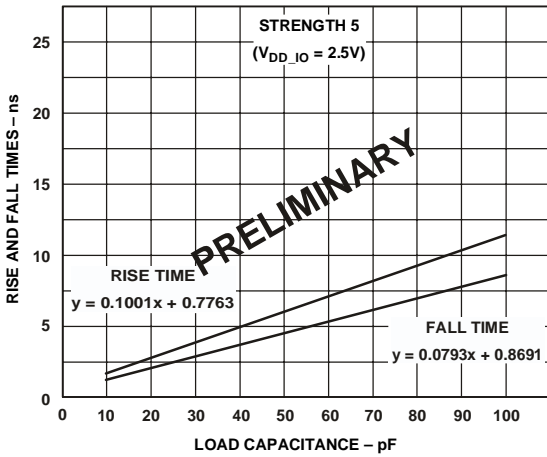

Figure 39. Typical Output Rise and Fall Time (10%–90%, $V_{DD_IO} = 2.5\text{ V}$) vs. Load Capacitance at Strength 5

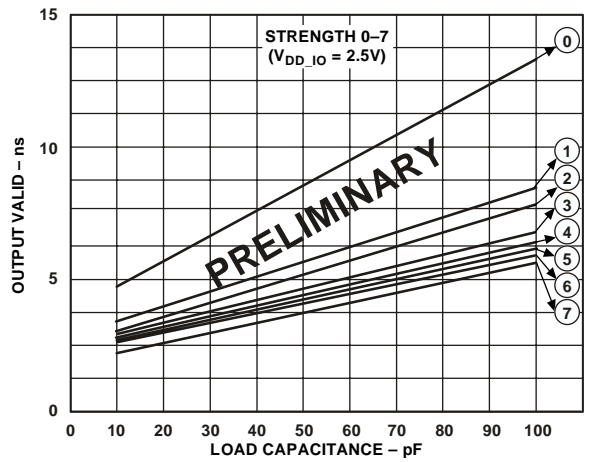

Figure 42. Typical Output Valid ($V_{DD_IO} = 2.5\text{ V}$) vs. Load Capacitance at Max Case Temperature and Strength 0–7¹

¹The line equations for the output valid versus load capacitance are:

- Strength 0: $y = 0.0956x + 3.5662$
- Strength 1: $y = 0.0523x + 3.2144$
- Strength 2: $y = 0.0433x + 3.1319$
- Strength 3: $y = 0.0391x + 2.9675$
- Strength 4: $y = 0.0393x + 2.7653$
- Strength 5: $y = 0.0373x + 2.6515$
- Strength 6: $y = 0.0379x + 2.1206$
- Strength 7: $y = 0.0399x + 1.9080$

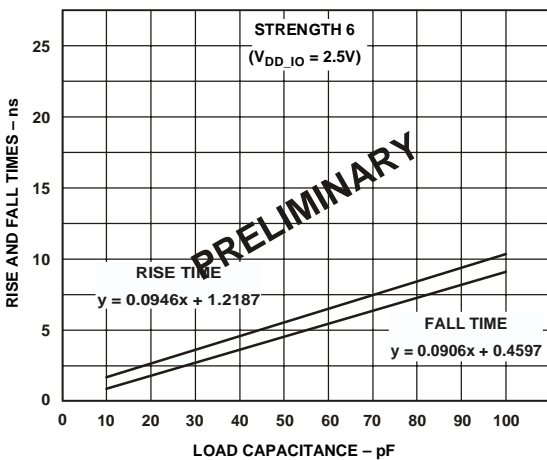

Figure 40. Typical Output Rise and Fall Time (10%–90%, $V_{DD_IO} = 2.5\text{ V}$) vs. Load Capacitance at Strength 6

ENVIRONMENTAL CONDITIONS

The ADSP-TS202S processor is rated for performance over the extended commercial temperature range, $T_{CASE} = -40^{\circ}\text{C}$ to 85°C .

Thermal Characteristics

The ADSP-TS202S processor is packaged in a 25 mm × 25 mm thermally enhanced Ball Grid Array (BGA_ED). The ADSP-TS202S processor is specified for a case temperature (T_{CASE}). To ensure that the T_{CASE} data sheet specification is not exceeded, a heatsink and/or an air flow source may be used.

Table 27 shows the thermal characteristics of the 25 mm × 25 mm BGA_ED package.

Table 27. Thermal Characteristics for 25 mm × 25 mm Package

| Parameter | Condition | Typical | Units |
|---------------|-----------------|---------|-----------------------------|
| θ_{JA} | Airflow = 0 m/s | 19.6 | $^{\circ}\text{C}/\text{W}$ |
| | Airflow = 1 m/s | 15.4 | $^{\circ}\text{C}/\text{W}$ |
| | Airflow = 2 m/s | 13.7 | $^{\circ}\text{C}/\text{W}$ |
| θ_{JC} | – | 0.7 | $^{\circ}\text{C}/\text{W}$ |
| θ_{JB} | – | 8.3 | $^{\circ}\text{C}/\text{W}$ |

576-BALL BGA_ED PIN CONFIGURATIONS

Figure 43 shows a summary of pin configurations for the 576-ball BGA_ED package and Table 28 lists the signal-to-ball assignments.

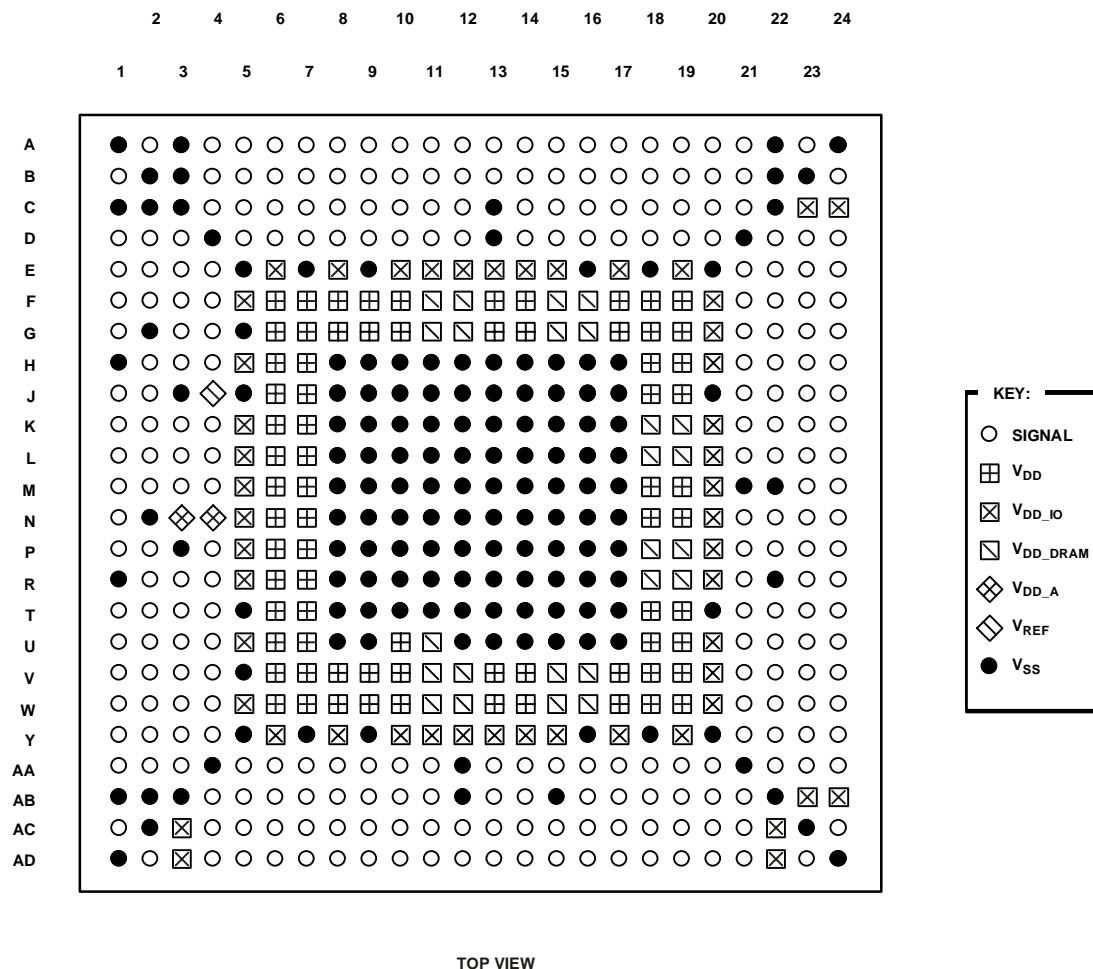

Figure 43. 576-ball BGA_ED Pin Configurations¹ (top view, Summary)

¹ For a more detailed pin summary diagram, see the EE-179: ADSP-TS201S System Design Guidelines on the Analog Devices website (www.analog.com)

Table 28. 576-Ball (25 mm × 25 mm) BGA_ED Pin Assignments

| Pin# | Signal Name | Pin# | Signal Name | Pin# | Signal Name | Pin# | Signal Name |
|------|-------------------------|------|-------------------------|------|---------------------------|------|---------------------------|
| A1 | V _{SS} | B1 | DATA53 | C1 | V _{SS} | D1 | DATA55 |
| A2 | DATA51 | B2 | V _{SS} | C2 | V _{SS} | D2 | DATA56 |
| A3 | V _{SS} | B3 | V _{SS} | C3 | V _{SS} | D3 | DATA54 |
| A4 | DATA49 | B4 | DATA50 | C4 | DATA52 | D4 | V _{SS} |
| A5 | DATA43 | B5 | DATA44 | C5 | DATA47 | D5 | DATA48 |
| A6 | DATA41 | B6 | DATA42 | C6 | DATA45 | D6 | DATA46 |
| A7 | DATA37 | B7 | DATA38 | C7 | DATA39 | D7 | DATA40 |
| A8 | DATA33 | B8 | DATA34 | C8 | DATA35 | D8 | DATA36 |
| A9 | DATA29 | B9 | DATA30 | C9 | DATA31 | D9 | DATA32 |
| A10 | DATA25 | B10 | DATA26 | C10 | DATA27 | D10 | DATA28 |
| A11 | DATA23 | B11 | DATA24 | C11 | DATA21 | D11 | DATA22 |
| A12 | DATA19 | B12 | DATA20 | C12 | DATA17 | D12 | DATA18 |
| A13 | DATA15 | B13 | DATA16 | C13 | V _{SS} | D13 | V _{SS} |
| A14 | DATA11 | B14 | DATA12 | C14 | DATA13 | D14 | DATA14 |
| A15 | DATA9 | B15 | DATA10 | C15 | DATA7 | D15 | DATA8 |
| A16 | DATA5 | B16 | DATA6 | C16 | DATA3 | D16 | DATA4 |
| A17 | DATA1 | B17 | DATA2 | C17 | ACK | D17 | DATA0 |
| A18 | $\overline{\text{WRL}}$ | B18 | $\overline{\text{WRH}}$ | C18 | $\overline{\text{RD}}$ | D18 | $\overline{\text{BRST}}$ |
| A19 | ADDR30 | B19 | ADDR31 | C19 | ADDR26 | D19 | ADDR27 |
| A20 | ADDR28 | B20 | ADDR29 | C20 | ADDR24 | D20 | ADDR25 |
| A21 | ADDR22 | B21 | ADDR23 | C21 | ADDR20 | D21 | V _{SS} |
| A22 | V _{SS} | B22 | V _{SS} | C22 | V _{SS} | D22 | ADDR19 |
| A23 | ADDR21 | B23 | V _{SS} | C23 | V _{DD_IO} | D23 | ADDR17 |
| A24 | V _{SS} | B24 | ADDR18 | C24 | V _{DD_IO} | D24 | ADDR16 |
| E1 | DATA61 | F1 | DATA63 | G1 | $\overline{\text{MSSD1}}$ | H1 | V _{SS} |
| E2 | DATA62 | F2 | $\overline{\text{MST}}$ | G2 | V _{SS} | H2 | $\overline{\text{MSH}}$ |
| E3 | DATA57 | F3 | DATA59 | G3 | $\overline{\text{MS0}}$ | H3 | $\overline{\text{MSSD3}}$ |
| E4 | DATA58 | F4 | DATA60 | G4 | $\overline{\text{BMS}}$ | H4 | SCLKRATO |
| E5 | V _{SS} | F5 | V _{DD_IO} | G5 | V _{SS} | H5 | V _{DD_IO} |
| E6 | V _{DD_IO} | F6 | V _{DD} | G6 | V _{DD} | H6 | V _{DD} |
| E7 | V _{SS} | F7 | V _{DD} | G7 | V _{DD} | H7 | V _{DD} |
| E8 | V _{DD_IO} | F8 | V _{DD} | G8 | V _{DD} | H8 | V _{SS} |
| E9 | V _{SS} | F9 | V _{DD} | G9 | V _{DD} | H9 | V _{SS} |
| E10 | V _{DD_IO} | F10 | V _{DD} | G10 | V _{DD} | H10 | V _{SS} |
| E11 | V _{DD_IO} | F11 | V _{DD_DRAM} | G11 | V _{DD_DRAM} | H11 | V _{SS} |
| E12 | V _{DD_IO} | F12 | V _{DD_DRAM} | G12 | V _{DD_DRAM} | H12 | V _{SS} |
| E13 | V _{DD_IO} | F13 | V _{DD} | G13 | V _{DD} | H13 | V _{SS} |
| E14 | V _{DD_IO} | F14 | V _{DD} | G14 | V _{DD} | H14 | V _{SS} |
| E15 | V _{DD_IO} | F15 | V _{DD_DRAM} | G15 | V _{DD_DRAM} | H15 | V _{SS} |
| E16 | V _{SS} | F16 | V _{DD_DRAM} | G16 | V _{DD_DRAM} | H16 | V _{SS} |
| E17 | V _{DD_IO} | F17 | V _{DD} | G17 | V _{DD} | H17 | V _{SS} |
| E18 | V _{SS} | F18 | V _{DD} | G18 | V _{DD} | H18 | V _{DD} |
| E19 | V _{DD_IO} | F19 | V _{DD} | G19 | V _{DD} | H19 | V _{DD} |
| E20 | V _{SS} | F20 | V _{DD_IO} | G20 | V _{DD_IO} | H20 | V _{DD_IO} |
| E21 | ADDR15 | F21 | ADDR13 | G21 | ADDR7 | H21 | ADDR3 |
| E22 | ADDR14 | F22 | ADDR12 | G22 | ADDR6 | H22 | ADDR2 |
| E23 | ADDR11 | F23 | ADDR9 | G23 | ADDR5 | H23 | ADDR1 |
| E24 | ADDR10 | F24 | ADDR8 | G24 | ADDR4 | H24 | ADDR0 |

Table 28. 576-Ball (25 mm × 25 mm) BGA_ED Pin Assignments (Continued)

| Pin# | Signal Name | Pin# | Signal Name | Pin# | Signal Name | Pin# | Signal Name |
|------|--------------------|------|----------------------|------|-----------------------------|------|--------------------|
| J1 | RAS | K1 | SDA10 | L1 | SDWE | M1 | BR3 |
| J2 | CAS | K2 | SDCKE | L2 | BR0 | M2 | SCLKRAT1 |
| J3 | V _{SS} | K3 | LDQM | L3 | BR1 | M3 | BR5 |
| J4 | V _{REF} | K4 | HDQM | L4 | BR2 | M4 | BR6 |
| J5 | V _{SS} | K5 | V _{DD_IO} | L5 | V _{DD_IO} | M5 | V _{DD_IO} |
| J6 | V _{DD} | K6 | V _{DD} | L6 | V _{DD} | M6 | V _{DD} |
| J7 | V _{DD} | K7 | V _{DD} | L7 | V _{DD} | M7 | V _{DD} |
| J8 | V _{SS} | K8 | V _{SS} | L8 | V _{SS} | M8 | V _{SS} |
| J9 | V _{SS} | K9 | V _{SS} | L9 | V _{SS} | M9 | V _{SS} |
| J10 | V _{SS} | K10 | V _{SS} | L10 | V _{SS} | M10 | V _{SS} |
| J11 | V _{SS} | K11 | V _{SS} | L11 | V _{SS} | M11 | V _{SS} |
| J12 | V _{SS} | K12 | V _{SS} | L12 | V _{SS} | M12 | V _{SS} |
| J13 | V _{SS} | K13 | V _{SS} | L13 | V _{SS} | M13 | V _{SS} |
| J14 | V _{SS} | K14 | V _{SS} | L14 | V _{SS} | M14 | V _{SS} |
| J15 | V _{SS} | K15 | V _{SS} | L15 | V _{SS} | M15 | V _{SS} |
| J16 | V _{SS} | K16 | V _{SS} | L16 | V _{SS} | M16 | V _{SS} |
| J17 | V _{SS} | K17 | V _{SS} | L17 | V _{SS} | M17 | V _{SS} |
| J18 | V _{DD} | K18 | V _{DD_DRAM} | L18 | V _{DD_DRAM} | M18 | V _{DD} |
| J19 | V _{DD} | K19 | V _{DD_DRAM} | L19 | V _{DD_DRAM} | M19 | V _{DD} |
| J20 | V _{SS} | K20 | V _{DD_IO} | L20 | V _{DD_IO} | M20 | V _{DD_IO} |
| J21 | LOACKO | K21 | LODAT11_N | L21 | LODAT13_N | M21 | V _{SS} |
| J22 | LOBCMPI | K22 | LODAT11_P | L22 | LODAT13_P | M22 | V _{SS} |
| J23 | LODAT10_N | K23 | LOCLKINN | L23 | LODAT12_N | M23 | LODATO3_N |
| J24 | LODAT10_P | K24 | LOCLKINP | L24 | LODAT12_P | M24 | LODATO3_P |
| N1 | ID0 | P1 | SCLK | R1 | V _{SS} | T1 | RST_IN |
| N2 | V _{SS} | P2 | SCLK_VREF | R2 | NC (SCLK) ¹ | T2 | SCLKRAT2 |
| N3 | V _{DD_A} | P3 | V _{SS} | R3 | NC (SCLK_VREF) ¹ | T3 | BR4 |
| N4 | V _{DD_A} | P4 | BM | R4 | BR7 | T4 | DSO |
| N5 | V _{DD_IO} | P5 | V _{DD_IO} | R5 | V _{DD_IO} | T5 | V _{SS} |
| N6 | V _{DD} | P6 | V _{DD} | R6 | V _{DD} | T6 | V _{DD} |
| N7 | V _{DD} | P7 | V _{DD} | R7 | V _{DD} | T7 | V _{DD} |
| N8 | V _{SS} | P8 | V _{SS} | R8 | V _{SS} | T8 | V _{SS} |
| N9 | V _{SS} | P9 | V _{SS} | R9 | V _{SS} | T9 | V _{SS} |
| N10 | V _{SS} | P10 | V _{SS} | R10 | V _{SS} | T10 | V _{SS} |
| N11 | V _{SS} | P11 | V _{SS} | R11 | V _{SS} | T11 | V _{SS} |
| N12 | V _{SS} | P12 | V _{SS} | R12 | V _{SS} | T12 | V _{SS} |
| N13 | V _{SS} | P13 | V _{SS} | R13 | V _{SS} | T13 | V _{SS} |
| N14 | V _{SS} | P14 | V _{SS} | R14 | V _{SS} | T14 | V _{SS} |
| N15 | V _{SS} | P15 | V _{SS} | R15 | V _{SS} | T15 | V _{SS} |
| N16 | V _{SS} | P16 | V _{SS} | R16 | V _{SS} | T16 | V _{SS} |
| N17 | V _{SS} | P17 | V _{SS} | R17 | V _{SS} | T17 | V _{SS} |
| N18 | V _{DD} | P18 | V _{DD_DRAM} | R18 | V _{DD_DRAM} | T18 | V _{DD} |
| N19 | V _{DD} | P19 | V _{DD_DRAM} | R19 | V _{DD_DRAM} | T19 | V _{DD} |
| N20 | V _{DD_IO} | P20 | V _{DD_IO} | R20 | V _{DD_IO} | T20 | V _{SS} |
| N21 | LODATO2_N | P21 | LODATO1_N | R21 | NC | T21 | L1DATIO_N |
| N22 | LODATO2_P | P22 | LODATO1_P | R22 | V _{SS} | T22 | L1DATIO_P |
| N23 | LOCLKON | P23 | LODATO0_N | R23 | LOBCMPO | T23 | L1ACKO |
| N24 | LOCLKOP | P24 | LODATO0_P | R24 | LOACKI | T24 | L1TCMPI |

Table 28. 576-Ball (25 mm × 25 mm) BGA_ED Pin Assignments (Continued)

| Pin# | Signal Name | Pin# | Signal Name | Pin# | Signal Name | Pin# | Signal Name |
|------|----------------------|------|----------------------|------|----------------------|------|--------------------|
| U1 | MSSD0 | V1 | MSSD2 | W1 | CONTROLIMPO | Y1 | EMU |
| U2 | RST_OUT | V2 | DS2 | W2 | ENEDREG | Y2 | TCK |
| U3 | ID2 | V3 | POR_IN | W3 | TDI | Y3 | TMROE |
| U4 | DS1 | V4 | CONTROLIMP1 | W4 | TDO | Y4 | FLAG3 |
| U5 | V _{DD_IO} | V5 | V _{SS} | W5 | V _{DD_IO} | Y5 | V _{SS} |
| U6 | V _{DD} | V6 | V _{DD} | W6 | V _{DD} | Y6 | V _{DD_IO} |
| U7 | V _{DD} | V7 | V _{DD} | W7 | V _{DD} | Y7 | V _{SS} |
| U8 | V _{SS} | V8 | V _{DD} | W8 | V _{DD} | Y8 | V _{DD_IO} |
| U9 | V _{SS} | V9 | V _{DD} | W9 | V _{DD} | Y9 | V _{SS} |
| U10 | V _{DD} | V10 | V _{DD} | W10 | V _{DD} | Y10 | V _{DD_IO} |
| U11 | V _{DD_DRAM} | V11 | V _{DD_DRAM} | W11 | V _{DD_DRAM} | Y11 | V _{DD_IO} |
| U12 | V _{SS} | V12 | V _{DD_DRAM} | W12 | V _{DD_DRAM} | Y12 | V _{DD_IO} |
| U13 | V _{SS} | V13 | V _{DD} | W13 | V _{DD} | Y13 | V _{DD_IO} |
| U14 | V _{SS} | V14 | V _{DD} | W14 | V _{DD} | Y14 | V _{DD_IO} |
| U15 | V _{SS} | V15 | V _{DD_DRAM} | W15 | V _{DD_DRAM} | Y15 | V _{DD_IO} |
| U16 | V _{SS} | V16 | V _{DD_DRAM} | W16 | V _{DD_DRAM} | Y16 | V _{SS} |
| U17 | V _{SS} | V17 | V _{DD} | W17 | V _{DD} | Y17 | V _{DD_IO} |
| U18 | V _{DD} | V18 | V _{DD} | W18 | V _{DD} | Y18 | V _{SS} |
| U19 | V _{DD} | V19 | V _{DD} | W19 | V _{DD} | Y19 | V _{DD_IO} |
| U20 | V _{DD_IO} | V20 | V _{DD_IO} | W20 | V _{DD_IO} | Y20 | V _{SS} |
| U21 | L1CLKINN | V21 | L1DATI3_N | W21 | L1CLKON | Y21 | L1DATO1_N |
| U22 | L1CLKINP | V22 | L1DATI3_P | W22 | L1CLKOP | Y22 | L1DATO1_P |
| U23 | L1DATI1_N | V23 | L1DATI2_N | W23 | L1DATO3_N | Y23 | L1DATO2_N |
| U24 | L1DATI1_P | V24 | L1DATI2_P | W24 | L1DATO3_P | Y24 | L1DATO2_P |
| AA1 | FLAG2 | AB1 | V _{SS} | AC1 | FLAG0 | AD1 | V _{SS} |
| AA2 | FLAG1 | AB2 | V _{SS} | AC2 | V _{SS} | AD2 | ID1 |
| AA3 | TRQ3 | AB3 | V _{SS} | AC3 | V _{DD_IO} | AD3 | V _{DD_IO} |
| AA4 | V _{SS} | AB4 | NC | AC4 | TMS | AD4 | TRST |
| AA5 | TRQ0 | AB5 | TRQ2 | AC5 | TOWR | AD5 | TRD |
| AA6 | IOEN | AB6 | TRQ1 | AC6 | DMAR2 | AD6 | DMAR3 |
| AA7 | DMAR0 | AB7 | DMAR1 | AC7 | CPA | AD7 | DPA |
| AA8 | HBR | AB8 | HBG | AC8 | BOFF | AD8 | BUSLOCK |
| AA9 | L3BCMPO | AB9 | L3ACKI | AC9 | L3DATO0_N | AD9 | L3DATO0_P |
| AA10 | L3DATO1_N | AB10 | L3DATO1_P | AC10 | L3CLKON | AD10 | L3CLKOP |
| AA11 | L3DATO3_N | AB11 | L3DATO3_P | AC11 | L3DATO2_N | AD11 | L3DATO2_P |
| AA12 | V _{SS} | AB12 | V _{SS} | AC12 | L3DATI3_N | AD12 | L3DATI3_P |
| AA13 | L3DATI2_N | AB13 | L3DATI2_P | AC13 | L3CLKINN | AD13 | L3CLKINP |
| AA14 | L3DATI1_N | AB14 | L3DATI1_P | AC14 | L3DATI0_N | AD14 | L3DATI0_P |
| AA15 | NC | AB15 | V _{SS} | AC15 | L3ACKO | AD15 | L3BCMPI |
| AA16 | L2DATO0_N | AB16 | L2DATO0_P | AC16 | L2BCMPO | AD16 | L2ACKI |
| AA17 | L2CLKON | AB17 | L2CLKOP | AC17 | L2DATO1_N | AD17 | L2DATO1_P |
| AA18 | L2DATO3_N | AB18 | L2DATO3_P | AC18 | L2DATO2_N | AD18 | L2DATO2_P |
| AA19 | L2CLKINN | AB19 | L2CLKINP | AC19 | L2DATI3_N | AD19 | L2DATI3_P |
| AA20 | L2DATI1_N | AB20 | L2DATI1_P | AC20 | L2DATI2_N | AD20 | L2DATI2_P |
| AA21 | V _{SS} | AB21 | L2ACKO | AC21 | L2DATI0_N | AD21 | L2DATI0_P |
| AA22 | L1BCMPO | AB22 | V _{SS} | AC22 | V _{DD_IO} | AD22 | V _{DD_IO} |
| AA23 | L1DATO0_N | AB23 | V _{DD_IO} | AC23 | V _{SS} | AD23 | L2BCMPI |
| AA24 | L1DATO0_P | AB24 | V _{DD_IO} | AC24 | L1ACKI | AD24 | V _{SS} |

¹ On revision 1.x silicon, the R2 and R3 pins are NC. On revision 0.x silicon, the R2 pin is SCLK, and the R3 pin is SCLK_V_{REF}. For more information on SCLK and SCLK_V_{REF} on revision 0.x silicon, see the EE-179: ADSP-TS20x TigerSHARC System Design Guidelines on the Analog Devices website (www.analog.com).

OUTLINE DIMENSIONS

The ADSP-TS202S processor is available in a 25 mm × 25 mm, 576-ball metric thermally enhanced Ball Grid Array (BGA_ED) package with 24 rows of balls (BP-576).

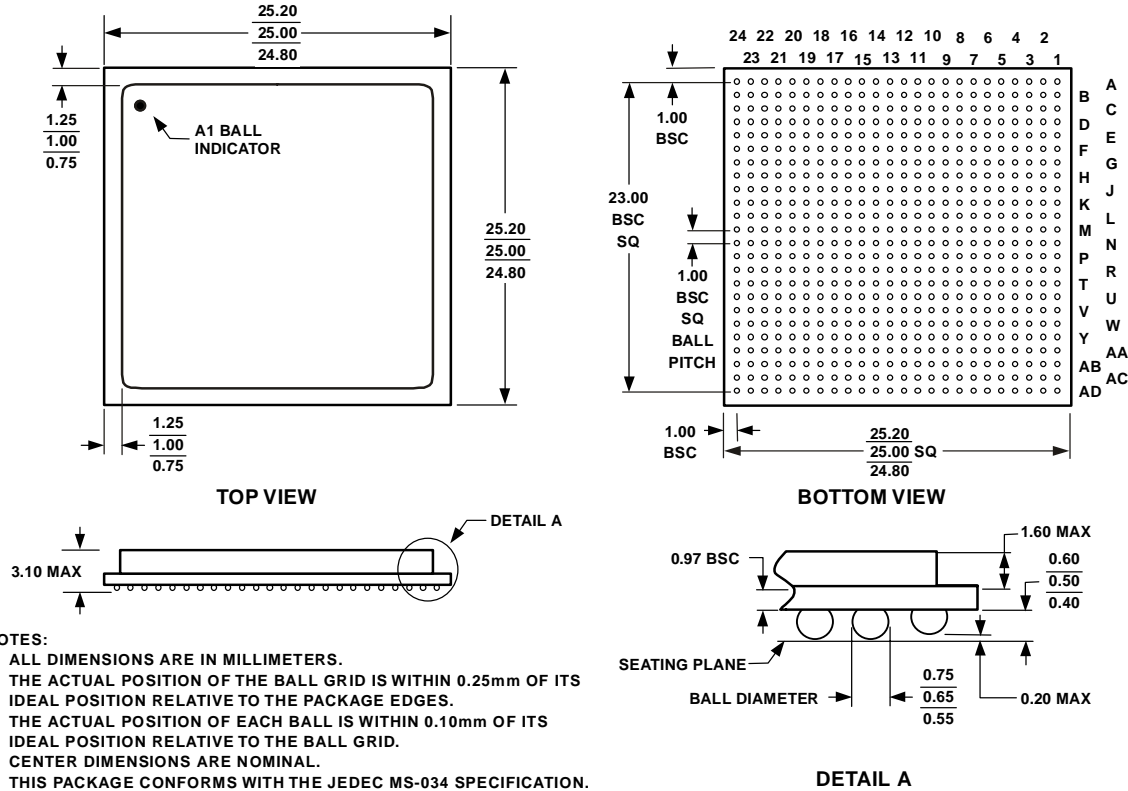

Figure 44. 576-ball BGA_ED (BP-576)

ORDERING GUIDE

| Part Number ^{1,2,3,4} | Case Temperature Range | Instruction Rate ⁵ | On-chip DRAM | Operating Voltage | Package |
|--------------------------------|------------------------|-------------------------------|--------------|---------------------------------------------------------------------------|-----------------------|
| ADSP-TS202SABP-X | -40°C to 85°C | 500 MHz | 12Mbit | 1.0 V _{DD} 2.5 V _{DD,IO} 1.5 V _{DD,DRAM} | (BP-576) ⁶ |

¹ S indicates 1.0/2.5 V supplies.

² A indicates -40°C to 85°C temperature.

³ BP indicated thermally enhanced Ball Grid Array (BGA_ED) package.

⁴ -X indicates engineering grade product.

⁵ The instruction rate is the same as the internal DSP clock (CCLK) rate.

⁶ The BP-576 package measures 25mm × 25mm.