

## SCRs

### General Description

Available either in sensitive or standard gate triggering levels, the 12A SCR series is suitable to fit all modes of control found in applications such as overvoltage crowbar protection, motor control circuits in power tools and kitchen aids, in-rush current limiting circuits, capacitive discharge ignition, voltage regulation circuits...

### Features

- ◆ Repetitive Peak Off-State Voltage : 600V and 800V
- ◆ R.M.S On-State Current (  $I_{T(RMS)} = 12\text{ A}$  )
- ◆ These are Pb-Free Devices

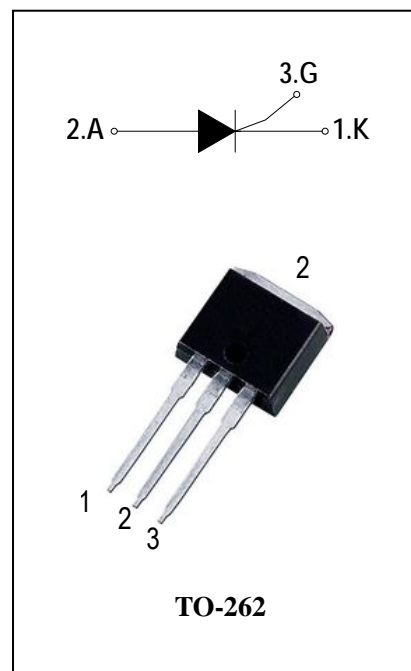

### Absolute Maximum Ratings

Symbol	Items	Conditions		Ratings	Unit
$V_{DRM}$	Repetitive Peak Off-State Voltage	$T_j = 25^\circ\text{C}$	ADT12A60I	600	V
$V_{RRM}$	Repetitive peak reverse voltage		ADT12A80I	800	V
$I_{T(AV)}$	Average On-State Current	Half Sine Wave , $T_c = 110^\circ\text{C}$		10	A
$I_{T(RMS)}$	R.M.S On-State Current	Half Sine Wave , $T_c = 110^\circ\text{C}$		12	A
$I_{TSM}$	Surge On-State Current	1/2 Cycle, Sine Wave Non-Repetitive, $t_p = 10\text{ms}(50\text{Hz}) T_j = 25^\circ\text{C}$		190	A
$I^2t$	$I^2t$ for Fusing	$T_j = 25^\circ\text{C}, t_p = 10\text{ms}$		98	$\text{A}^2\text{S}$
$P_{GM}$	Forward Peak Gate Power Dissipation	$T_j = 125^\circ\text{C}, \text{Pulse Width} \leq 20\mu\text{s}$		5	W
$P_{G(AV)}$	Forward Average Gate Power Dissipation	$T_j = 25^\circ\text{C}, t_p = 10\text{ms}$		1	W
$I_{GM}$	Peak Gate Current	$T_j = 125^\circ\text{C}, \text{Pulse Width} \leq 20\mu\text{s}$		4	A
$T_j$	Operating Junction Temperature			- 40 ~ 125	$^\circ\text{C}$
$T_{STG}$	Storage Temperature			- 40 ~ 150	$^\circ\text{C}$



## Electrical Characteristics ( $T_j = 25^\circ\text{C}$ unless otherwise specified )

Symbol	Items	Conditions		ADT12A60I/80I			Unit
				T	S	Blank	
$I_{DRM}$	Peak Forward Reverse	$V_{DRM} = V_{RRM}, R_{GK} = 1K\Omega$ $T_j = 25^\circ\text{C}$	Max.	5			$\mu\text{A}$
$I_{RRM}$	Blocking Current	$V_{DRM} = V_{RRM}, R_{GK} = 1K\Omega$ $T_j = 125^\circ\text{C}$		2			$\text{mA}$
$V_{TM}$	Peak On-State Voltage	$I_{TM} = 24\text{A}, t_p = 380 \mu\text{s}$	Max.	1.55			$\text{V}$
$V_{GD}$	Non-Trigger Gate Voltage	$V_D = V_{DRM} \quad R_L = 3.3 k\Omega$ $R_{GK} = 1K\Omega \quad T_j = 125^\circ\text{C}$	Min.	0.2			$\text{V}$
$V_{GT}$	Gate Trigger Voltage	$V_D = 12\text{V} , R_L = 33\Omega$	Max.	1.5			$\text{V}$
$I_{GT}$	Gate Trigger Current		Max.	0.2	15	30	$\text{mA}$
$I_H$	Holding Current	$I_T = 0.5\text{A} \quad R_{GK} = 1K\Omega$	Max.	5	30	40	$\text{mA}$
$I_L$	Latching Current	$I_G = 1.2 I_{GT} \quad R_{GK} = 1K\Omega$	Max.	7	50	60	$\text{mA}$
$dV/dt$	Critical Rate of Rise of Off-State Voltage	$V_D = 2/3V_{DRM} \quad \text{gate open}$ $R_{GK} = 1K\Omega \quad T_j = 125^\circ\text{C}$	Min.	200	500	600	$\text{V}/\mu\text{s}$
$R_{th(j-c)}$	Junction to case (AC)		Max.	1.3			$^\circ\text{C}/\text{W}$
$R_{th(j-a)}$	Junction to ambient		Max.	75			$^\circ\text{C}/\text{W}$

**FIG.1: Maximum average power dissipation (Single phase half wave)**

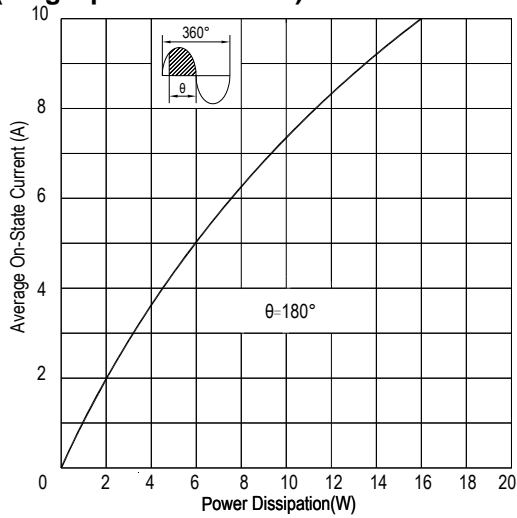

**FIG.2: Average on-state current VS Allowable case Temperature(Single phase half wave)**

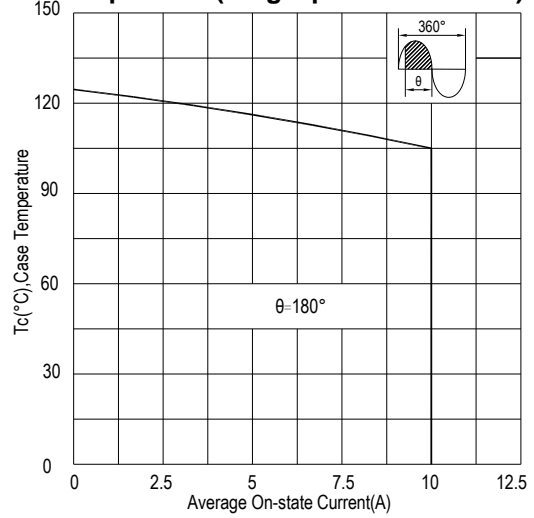

**FIG.3: Gate trigger current VS Junction temperature**

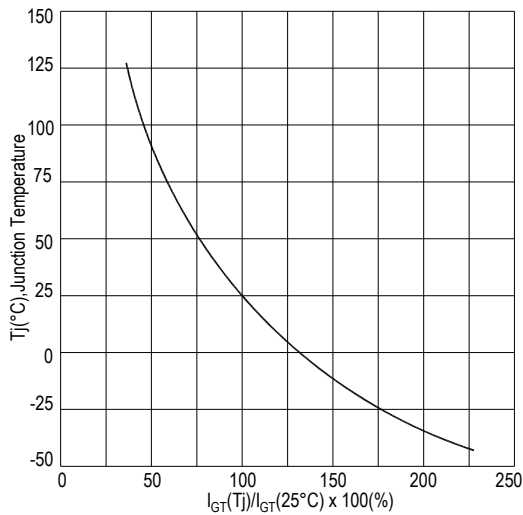

**FIG.4: Rated surge on-state current (Non-Repetitive)**

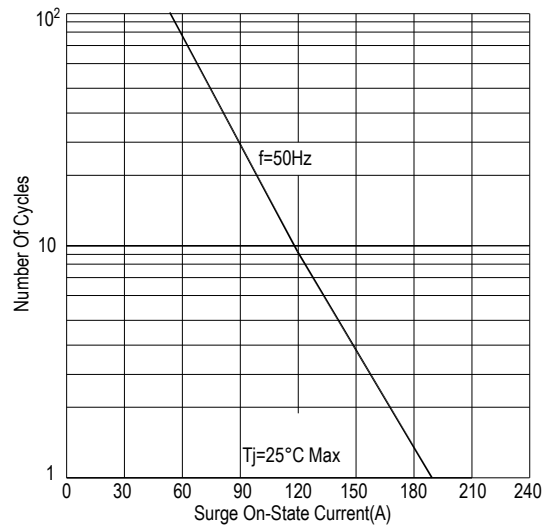

**FIG.5: On-state characteristics(Max)**

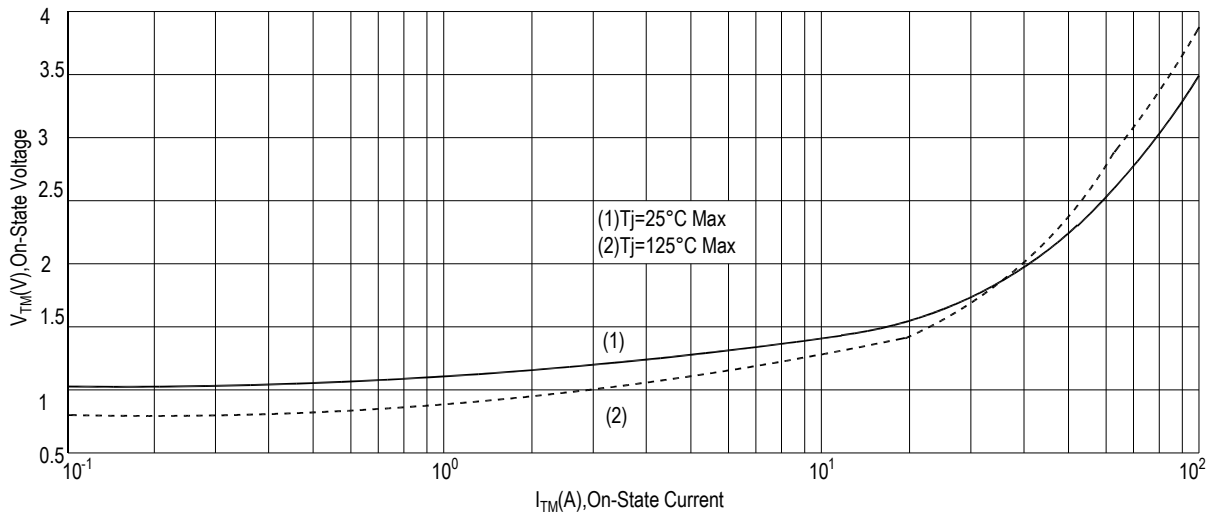

**FIG.6: Holding current and Latching current VS Junction temperature**

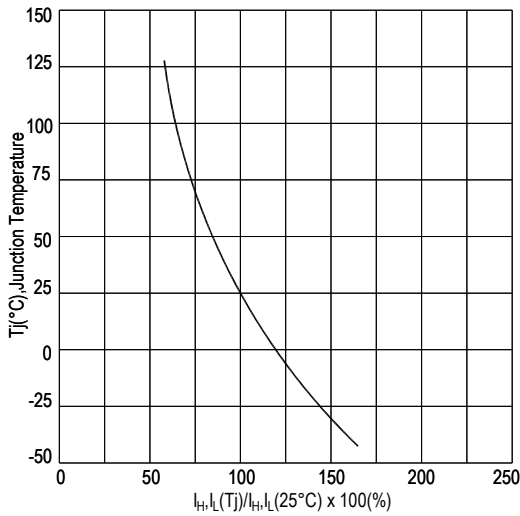

**FIG.7: Gate trigger voltage VS Junction temperature**

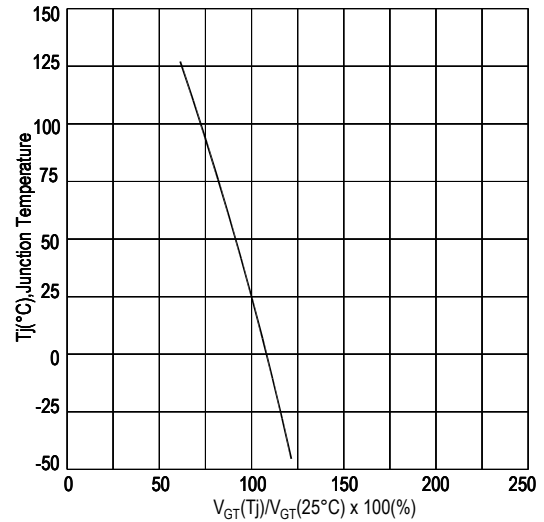

**FIG.8: Gate trigger current VS Junction temperature for type T gate triggering**

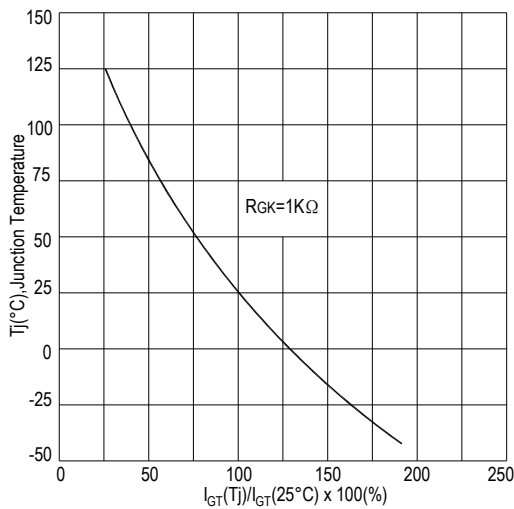

**FIG.8: Holding current and Latching current VS Junction temperature for type T gate triggering**

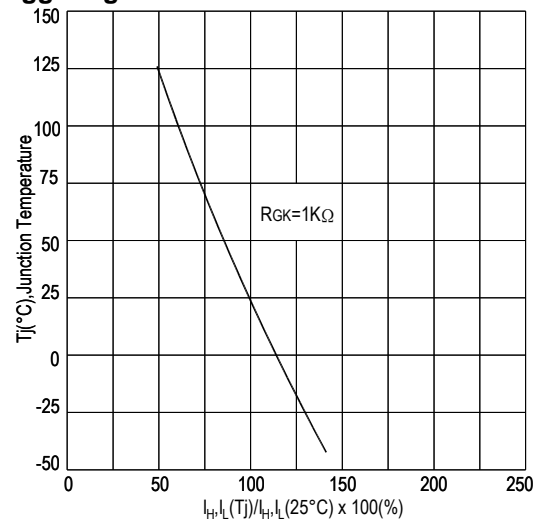

## PACKAGE MECHANICAL DATA TO-262 Package Dimension

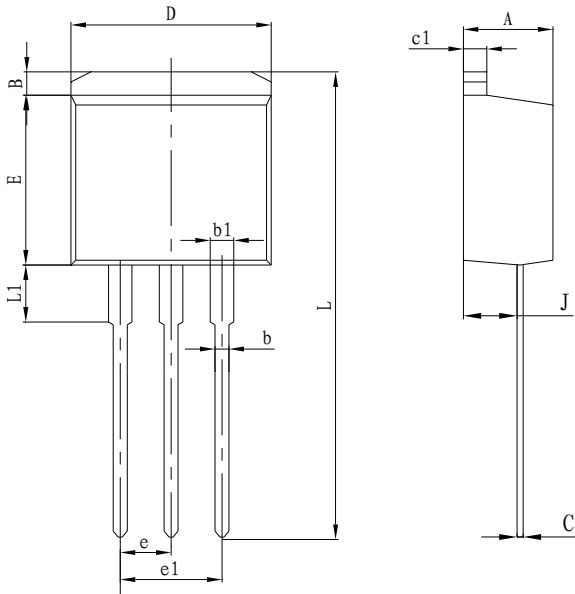

Symbol	Dimensions In Millimeters		Dimensions In Inches	
	Min	Max	Min	Max
A	4.450	4.670	0.175	0.184
B	1.170	1.370	0.046	0.054
b	0.710	0.910	0.028	0.036
b1	1.170	1.370	0.046	0.054
c	0.310	0.530	0.012	0.021
c1	1.170	1.370	0.046	0.054
D	9.950	10.310	0.392	0.406
E	9.400	9.600	0.370	0.378
e	2.540 TYP		0.100 TYP	
e1	4.980	5.180	0.196	0.204
L	23.25	23.45	0.915	0.923
L1	3.300	3.600	0.130	0.141
J	2.500	2.700	0.098	0.106

### Making Diagram

**ADV**: Logo  
**ADT12A60IS**: Part number  
**X**: Internal control code  
**H**: Halogen Free

AD T 12 A 80 I T(S)(W)

ADVANCED			
Internal control code			
Current: 12=12A			
SCR Series			
Voltage: 60=600V 80=800V			

Sensitivity and type:  
 T=0.2mA  
 S=15mA  
 Blank=30mA  
 W=80mA  
 Package explain: I=TO-262

### Ordering information

Part number	Package	Marking	Packing	Quantity
ADT12A60I#	TO-262	ADT12A60I#	Tube	50pcs
ADT12A80I#	TO-262	ADT12A80I#	Tube	50pcs

Note: # = Gate Trigger Current Sensitivity and type

### Notice

- 1 . All information included in this document such as product data, diagrams, charts, programs, algorithms, and application circuit examples, is current as of the date this document is issued. Such information, however, is subject to change without any prior notice. Before purchasing or using any ADV products listed in this document, please confirm the latest product information with a ADV sales office. Also, please pay regular and careful attention to additional and different information to be disclosed by ADV such as that disclosed through our website. (<http://www.advsemi.com> )
- 2 . ADV has used reasonable care in compiling the information included in this document, but ADV assumes no liability whatsoever for any damages incurred as a result of errors or omissions in the information included in this document.
- 3 . You should use the products described herein within the range specified by ADV, especially with respect to the maximum rating, operating supply voltage range, movement power voltage range, heat radiation characteristics, installation and other product characteristics. ADV shall have no liability for malfunctions or damages arising out of the use of ADV products beyond such specified ranges.
- 4 . When using or otherwise relying on the information in this document, you should evaluate the information in light of the total system before deciding about the applicability of such information to the intended application. ADV makes no representations, warranties or guaranties regarding the suitability of its products for any particular application and specifically disclaims any liability arising out of the application and use of the information in this document or ADV products.
- 5 . Although ADV endeavors to improve the quality and reliability of its products, IC products have specific characteristics such as the occurrence of failure at a certain rate and malfunctions under certain use conditions. Please be sure to implement safety measures to guard against the possibility of physical injury, and injury or damage caused by fire in the event of the failure of a ADV product, such as safety design for hardware and software including but not limited to redundancy, fire control and malfunction prevention, appropriate treatment for aging degradation or any other applicable measures. Among others, since the evaluation of microcomputer software alone is very difficult, please evaluate the safety of the final products or system manufactured by you.
- 6 . This document is provided for reference purposes only so that ADV customers may select the appropriate ADV products for their use. ADV neither makes warranties or representations with respect to the accuracy or completeness of the information contained in this document nor grants any license to any intellectual property rights or any other rights of ADV or any third party with respect to the information in this document.
- 7 . ADV shall have no liability for damages or infringement of any intellectual property or other rights arising out of the use of any information in this document, including, but not limited to, product data, diagrams, charts, programs, algorithms, and application circuit examples.
- 8 . This document may not be reproduced or duplicated, in any form, in whole or in part, without prior written approval from ADV.