



# Multiformat SDTV Video Decoder

## ADV7181B

### FEATURES

Multiformat video decoder supports NTSC-(M, J, 4.43), PAL-(B/D/G/H/I/M/N), SECAM

Integrates three 54 MHz, 9-bit ADCs

Clocked from a single 27 MHz crystal

Line-locked clock-compatible (LLC)

Adaptive Digital Line Length Tracking (ADLLT™), signal processing, and enhanced FIFO management give mini-TBC functionality

5-line adaptive comb filters

Proprietary architecture for locking to weak, noisy, and unstable video sources such as VCRs and tuners

Subcarrier frequency lock and status information output

Integrated AGC with adaptive peak white mode

Macrovision® copy protection detection

Chroma transient improvement (CTI)

Digital noise reduction (DNR)

Multiple programmable analog input formats

Composite video (CVBS)

S-Video (Y/C)

YPrPb component (VESA, MII, SMPTE, and BetaCam)

6 analog video input channels

Automatic NTSC/PAL/SECAM identification

Digital output formats (8-bit or 16-bit)

ITU-R BT.656 YCrCb 4:2:2 output + HS, VS, and FIELD

0.5 V to 1.6 V analog signal input range

Differential gain: 0.6% typ

Differential phase: 0.6° typ

### GENERAL DESCRIPTION

The ADV7181B integrated video decoder automatically detects and converts a standard analog baseband television signal compatible with worldwide standards NTSC, PAL, and SECAM into 4:2:2 component video data compatible with 16-bit/8-bit CCIR601/CCIR656.

The advanced, highly flexible digital output interface enables performance video decoding and conversion in line-locked clock-based systems. This makes the device ideally suited for a broad range of applications with diverse analog video characteristics, including tape-based sources, broadcast sources, security/surveillance cameras, and professional systems.

The six analog input channels accept standard composite, S-Video, and YPrPb video signals in an extensive number of combinations. AGC and clamp restore circuitry allow an input video signal peak-to-peak range of 0.5 V to 1.6 V. Alternatively, these can be bypassed for manual settings.

#### Rev. B

Information furnished by Analog Devices is believed to be accurate and reliable. However, no responsibility is assumed by Analog Devices for its use, nor for any infringements of patents or other rights of third parties that may result from its use. Specifications subject to change without notice. No license is granted by implication or otherwise under any patent or patent rights of Analog Devices. Trademarks and registered trademarks are the property of their respective owners.

### Programmable video controls

Peak white/hue/brightness/saturation/contrast

Integrated on-chip video timing generator

Free-run mode (generates stable video output with no I/P)

VBI decode support for

close captioning, WSS, CGMS, EDTV, Gemstar® 1×/2×

VBI decode support for

close captioning, WSS, CGMS, EDTV, and Gemstar® 1×/2×

Power-down mode

2-wire serial MPU interface (I<sup>2</sup>C®-compatible)

3.3 V analog, 1.8 V digital core; 3.3 V IO supply

Temperature grade: -40°C to +85°C

64-lead LQFP Pb-free package and 64-lead LFCSP package

### APPLICATIONS

DVD recorders

PC video

HDD-based PVRs/DVDRs

LCD TVs

Set-top boxes

Security systems

Digital televisions

Portable video devices

Automotive entertainment

AVR receivers

The fixed 54 MHz clocking of the ADCs and datapath for all modes allows very precise, accurate sampling and digital filtering. The line-locked clock output allows the output data rate, timing signals, and output clock signals to be synchronous, asynchronous, or line-locked even with ±5% line length variation. The output control signals allow glueless interface connections in almost any application. The ADV7181B modes are set up over a 2-wire, serial, bidirectional port (I<sup>2</sup>C-compatible).

The ADV7181B is fabricated in a 3.3 V CMOS process. Its monolithic CMOS construction ensures greater functionality with lower power dissipation.

The ADV7181B is available in two packages, a small 64-lead LQFP Pb-free package and a 64-lead LFCSP package.

## TABLE OF CONTENTS

Introduction .....	4	General Setup.....	20
Analog Front End.....	4	Color Controls.....	22
Standard Definition Processor .....	4	Clamp Operation.....	24
Functional Block Diagram .....	5	Luma Filter .....	25
Specifications.....	6	Chroma Filter.....	28
Electrical Characteristics.....	6	Gain Operation.....	29
Video Specifications.....	7	Chroma Transient Improvement (CTI) .....	32
Timing Specifications .....	8	Digital Noise Reduction (DNR).....	33
Analog Specifications.....	8	Comb Filters.....	33
Thermal Specifications .....	9	AV Code Insertion and Controls .....	36
Timing Diagrams.....	9	Synchronization Output Signals.....	38
Absolute Maximum Ratings.....	10	Sync Processing .....	46
ESD Caution.....	10	VBI Data Decode .....	46
Pin Configuration and Function Descriptions.....	11	Pixel Port Configuration .....	59
Analog Front End .....	13	MPU Port Description.....	60
Analog Input Muxing .....	13	Register Accesses.....	61
Global Control Registers .....	15	Register Programming.....	61
Power-Save Modes.....	15	I <sup>2</sup> C Sequencer.....	61
Reset Control .....	15	I <sup>2</sup> C Register Maps .....	62
Global Pin Control.....	16	I <sup>2</sup> C Register Map Details .....	67
Global Status Registers.....	18	I <sup>2</sup> C Programming Examples.....	88
Identification.....	18	Examples for 28 MHz Clock.....	88
Status 1 .....	18	Examples for 27 MHz Clock.....	92
Autodetection Result.....	18	PCB Layout Recommendations.....	95
Status 2 .....	18	Analog Interface Inputs.....	95
Status 3 .....	18	Power Supply Decoupling .....	95
Standard Definition Processor (SDP) .....	19	PLL .....	95
SD Luma Path .....	19	Digital Outputs (Both Data and Clocks) .....	95
SD Chroma Path.....	19	Digital Inputs .....	96
Sync Processing.....	20	Antialiasing Filters .....	96
VBI Data Recovery.....	20	Crystal Load Capacitor Value Selection.....	96

Typical Circuit Connection .....97  
 Outline Dimensions .....99

Ordering Guide .....100

**REVISION HISTORY**

**9/05—Rev. A to Rev. B**

Changes to Table 1 .....6  
 Changes to Table 2 .....7  
 Changes to Table 3 and Table 4 .....8  
 Changes to Table 5 .....9  
 Changes to Figure 5.....13  
 Changes to Figure 7.....19  
 Changes to Lock Related Controls Section.....21  
 Changes to Table References in BETACAM Section.....31  
 Changes to PAL Comb Filter Settings Section .....34  
 Changes to Figure 20 .....40  
 Change to NFTOG Section.....43  
 Changes to Table 84 .....67  
 Changes to Table 85 .....72

**7/05—Rev. 0 to Rev. A**

Changed Crystal References to 28 MHz Crystal..... Universal  
 Changes to General Description Section ..... 1  
 Changes to Analog Specifications Section .....8  
 Changes to Clamp Operation Section .....24

Changes to Figure 11 to Figure 14 .....28  
 Changes to Description of Chroma Filter.....28  
 Changes to Figure 15 .....29  
 Changes to Luma Gain LAGC[2:0] Bits Address.....30  
 Changes to VSEHE VS End Horizontal Position Section.....39  
 Changes to Table 54 .....41  
 Changes to Table 55 .....42  
 Changes to Table 83 .....67  
 Changes to Table 84 .....71  
 Changes to Table 85 .....88  
 Changes to Table 86 .....89  
 Changes to Table 87 .....90  
 Changes to Table 88 .....91  
 Added XTAL Load Capacitor Value Selection Section.....96  
 Replaced Figure 45.....98

**7/04—Revision 0: Initial Version**

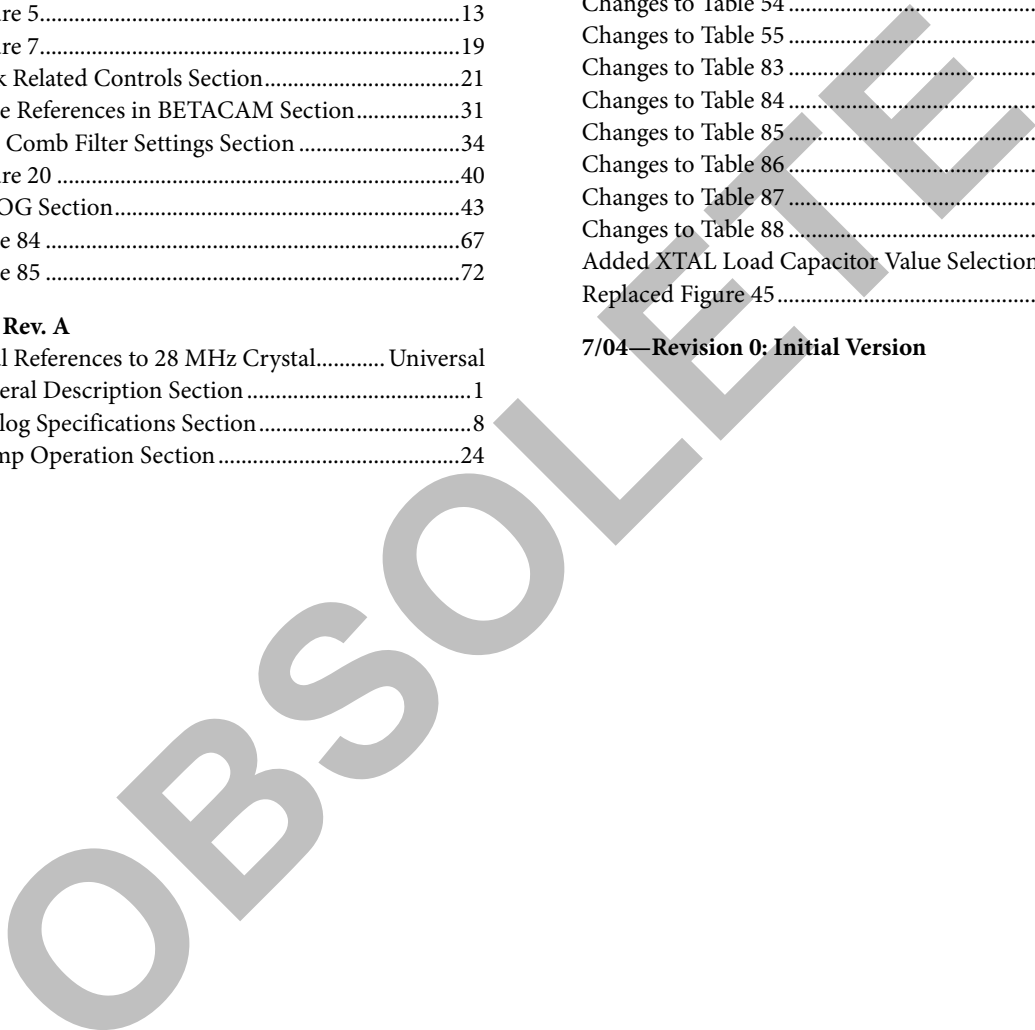

## INTRODUCTION

The ADV7181B is a high quality, single chip, multiformat video decoder that automatically detects and converts PAL, NTSC, and SECAM standards in the form of composite, S-Video, and component video into a digital ITU-R BT.656 format.

The advanced and highly flexible digital output interface enables performance video decoding and conversion in line-locked, clock-based systems. This makes the device ideally suited for a broad range of applications with diverse analog video characteristics, including tape-based sources, broadcast sources, security/surveillance cameras, and professional systems.

### ANALOG FRONT END

The ADV7181B analog front end comprises three 9-bit ADCs that digitize the analog video signal before applying it to the standard definition processor. The analog front end uses differential channels to each ADC to ensure high performance in mixed-signal applications.

The front end also includes a 6-channel input mux that enables multiple video signals to be applied to the ADV7181B. Current and voltage clamps are positioned in front of each ADC to ensure the video signal remains within the range of the converter. Fine clamping of the video signals is performed downstream by digital fine clamping within the ADV7181B. The ADCs are configured to run in 4× oversampling mode.

### STANDARD DEFINITION PROCESSOR

The ADV7181B is capable of decoding a large selection of baseband video signals in composite, S-Video, and component formats. The video standards supported by the ADV7181B

include PAL B/D/I/G/H, PAL60, PAL M, PAL N, PAL Nc, NTSC M/J, NTSC 4.43, and SECAM B/D/G/K/L. The ADV7181B can automatically detect the video standard and process it accordingly.

The ADV7181B has a 5-line, superadaptive, 2D comb filter that gives superior chrominance and luminance separation when decoding a composite video signal. This highly adaptive filter automatically adjusts its processing mode according to video standards and signal quality with no user intervention required. Video user controls, such as brightness, contrast, saturation, and hue, are also available within the ADV7181B.

The ADV7181B implements a patented ADLLT algorithm to track varying video line lengths from sources such as a VCR. ADLLT enables the ADV7181B to track and decode poor quality video sources such as VCRs, noisy sources from tuner outputs, VCD players, and camcorders. The ADV7181B contains a chroma transient improvement (CTI) processor that sharpens the edge rate of chroma transitions, resulting in sharper vertical transitions.

The ADV7181B can process a variety of VBI data services such as close captioning (CC), wide screen signaling (WSS), copy generation management system (CGMS), EDTV, Gemstar 1×/2×, and extended data service (XDS). The ADV7181B is fully Macrovision certified; detection circuitry enables Type I, Type II, and Type III protection levels to be identified and reported to the user. The decoder is also fully robust to all Macrovision signal inputs.

# FUNCTIONAL BLOCK DIAGRAM

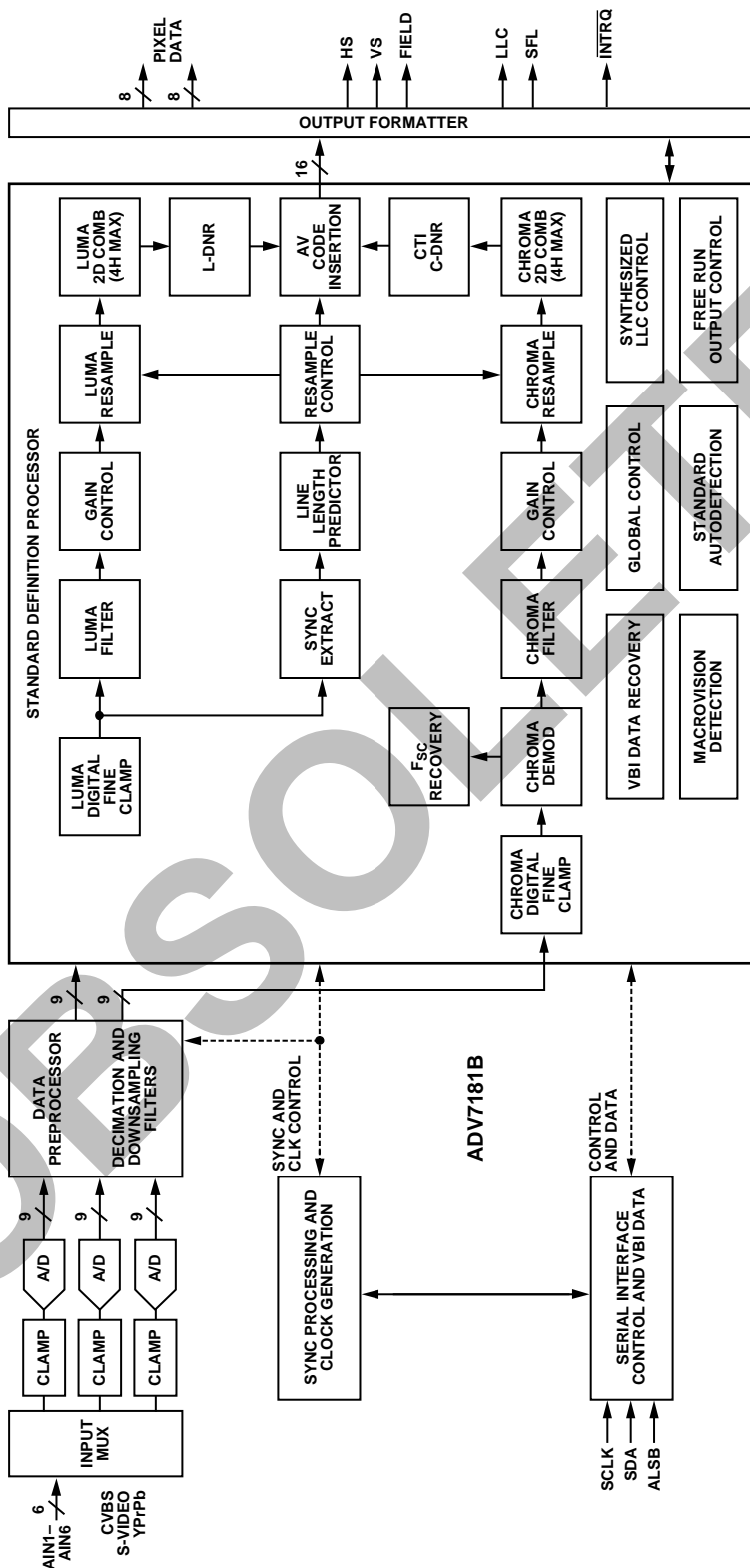

Figure 1.

04894-001

# ADV7181B

## SPECIFICATIONS

### ELECTRICAL CHARACTERISTICS

$A_{VDD} = 3.15\text{ V to }3.45\text{ V}$ ,  $D_{VDD} = 1.65\text{ V to }2.0\text{ V}$ ,  $D_{VDDIO} = 3.0\text{ V to }3.6\text{ V}$ ,  $P_{VDD} = 1.65\text{ V to }2.0\text{ V}$ ; operating temperature range, unless otherwise noted.

Table 1.

Parameter <sup>1, 2</sup>	Symbol	Test Conditions	Min	Typ	Max	Unit
<b>STATIC PERFORMANCE</b>						
Resolution (Each ADC)	N				9	Bits
Integral Nonlinearity	INL	BSL at 54 MHz		-0.475/+0.6	-1.5/+2	LSB
Differential Nonlinearity	DNL	BSL at 54 MHz		-0.25/+0.5	-0.7/+2	LSB
<b>DIGITAL INPUTS</b>						
Input High Voltage	$V_{IH}$		2			V
Input Low Voltage	$V_{IL}$				0.8	V
Input Current	$I_{IN}$	Pin 29 All other pins	-50 -10		+50 +10	$\mu\text{A}$ $\mu\text{A}$
Input Capacitance	$C_{IN}$				10	pF
<b>DIGITAL OUTPUTS</b>						
Output High Voltage	$V_{OH}$	$I_{SOURCE} = 0.4\text{ mA}$	2.4			V
Output Low Voltage	$V_{OL}$	$I_{SINK} = 3.2\text{ mA}$			0.4	V
High Impedance Leakage Current	$I_{LEAK}$				10	$\mu\text{A}$
Output Capacitance	$C_{OUT}$				20	pF
<b>POWER REQUIREMENTS<sup>3</sup></b>						
Digital Core Power Supply	$D_{VDD}$		1.65	1.8	2	V
Digital I/O Power Supply	$D_{VDDIO}$		3.0	3.3	3.6	V
PLL Power Supply	$P_{VDD}$		1.65	1.8	2.0	V
Analog Power Supply	$A_{VDD}$		3.15	3.3	3.45	V
Digital Core Supply Current	$I_{DVDD}$			80		mA
Digital I/O Supply Current	$I_{DVDDIO}$			2		mA
PLL Supply Current	$I_{PVDD}$			10.5		mA
Analog Supply Current	$I_{AVDD}$	CVBS input <sup>4</sup> YPrPb input <sup>5</sup>		85 180		mA mA
Power-Down Current	$I_{PWRDN}$			1.5		mA
Power-Up Time	$t_{PWUP}$			20		ms

<sup>1</sup>Temperature range:  $T_{MIN}$  to  $T_{MAX}$ , -40°C to +85°C.

<sup>2</sup>The min/max specifications are guaranteed over this range.

<sup>3</sup>Guaranteed by characterization.

<sup>4</sup>ADC1 and ADC2 powered down.

<sup>5</sup>All three ADCs powered on.

**VIDEO SPECIFICATIONS**

Guaranteed by characterization.  $A_{VDD} = 3.15\text{ V to }3.45\text{ V}$ ,  $D_{VDD} = 1.65\text{ V to }2.0\text{ V}$ ,  $D_{VDDIO} = 3.0\text{ V to }3.6\text{ V}$ ,  $P_{VDD} = 1.65\text{ V to }2.0\text{ V}$ ; operating temperature range, unless otherwise noted.

**Table 2.**

Parameter <sup>1, 2</sup>	Symbol	Test Conditions	Min	Typ	Max	Unit
<b>NONLINEAR SPECIFICATIONS</b>						
Differential Phase	DP	CVBS I/P, modulate 5-step		0.6	0.7	Degrees
Differential Gain	DG	CVBS I/P, modulate 5-step		0.6	0.7	%
Luma Nonlinearity	LNL	CVBS I/P, 5-step		0.6	0.7	%
<b>NOISE SPECIFICATIONS</b>						
SNR Unweighted		Luma ramp		54		dB
		Luma flat field		58		dB
Analog Front End Crosstalk				60		dB
<b>LOCK TIME SPECIFICATIONS</b>						
Horizontal Lock Range			-5		+5	%
Vertical Lock Range			40		70	Hz
$F_{SC}$ Subcarrier Lock Range				$\pm 1.3$		kHz
Color Lock In Time				60		Lines
Sync Depth Range			20		200	%
Color Burst Range			5		200	%
Vertical Lock Time				2		Fields
Autodetection Switch Speed				100		Lines
<b>CHROMA SPECIFICATIONS</b>						
Hue Accuracy	HUE			1		Degrees
Color Saturation Accuracy	CL_AC			1		%
Color AGC Range			5		400	%
Chroma Amplitude Error				0.5		%
Chroma Phase Error				0.5		Degrees
Chroma Luma Intermodulation				0.2		%
<b>LUMA SPECIFICATIONS</b>						
Luma Brightness Accuracy		CVBS, 1 V I/P		1		%
Luma Contrast Accuracy		CVBS, 1 V I/P		1		%

<sup>1</sup> Temperature range:  $T_{MIN}$  to  $T_{MAX}$ ,  $-40^{\circ}\text{C}$  to  $+85^{\circ}\text{C}$ .

<sup>2</sup> The min/max specifications are guaranteed over this range.

# ADV7181B

## TIMING SPECIFICATIONS

Guaranteed by characterization.  $A_{VDD} = 3.15 \text{ V to } 3.45 \text{ V}$ ,  $D_{VDD} = 1.65 \text{ V to } 2.0 \text{ V}$ ,  $D_{VDDIO} = 3.0 \text{ V to } 3.6 \text{ V}$ ,  $P_{VDD} = 1.65 \text{ V to } 2.0 \text{ V}$ ; operating temperature range, unless otherwise noted.

Table 3.

Parameter <sup>1,2</sup>	Symbol	Test Conditions	Min	Typ	Max	Unit
SYSTEM CLOCK AND CRYSTAL						
Nominal Frequency				27.00		MHz
Frequency Stability					±50	ppm
I <sup>2</sup> C PORT						
SCLK Frequency					400	kHz
SCLK Min Pulse Width High	t <sub>1</sub>		0.6			µs
SCLK Min Pulse Width Low	t <sub>2</sub>		1.3			µs
Hold Time (Start Condition)	t <sub>3</sub>		0.6			µs
Setup Time (Start Condition)	t <sub>4</sub>		0.6			µs
SDA Setup Time	t <sub>5</sub>		100			ns
SCLK and SDA Rise Time	t <sub>6</sub>				300	ns
SCLK and SDA Fall Time	t <sub>7</sub>				300	ns
Setup Time for Stop Condition	t <sub>8</sub>			0.6		µs
RESET FEATURE						
Reset Pulse Width			5			ms
CLOCK OUTPUTS						
LLC1 Mark Space Ratio	t <sub>9</sub> :t <sub>10</sub>		45:55		55:45	% duty cycle
DATA AND CONTROL OUTPUTS						
Data Output Transitional Time	t <sub>11</sub>	Negative clock edge to start of valid data (t <sub>ACCESS</sub> = t <sub>10</sub> - t <sub>11</sub> )			3.4	ns
Data Output Transitional Time	t <sub>12</sub>	End of valid data to negative clock edge (t <sub>HOLD</sub> = t <sub>9</sub> + t <sub>12</sub> )			2.4	ns

<sup>1</sup>Temperature range: T<sub>MIN</sub> to T<sub>MAX</sub>, -40°C to +85°C.

<sup>2</sup>The min/max specifications are guaranteed over this range.

## ANALOG SPECIFICATIONS

Guaranteed by characterization.  $A_{VDD} = 3.15 \text{ V to } 3.45 \text{ V}$ ,  $D_{VDD} = 1.65 \text{ V to } 2.0 \text{ V}$ ,  $D_{VDDIO} = 3.0 \text{ V to } 3.6 \text{ V}$ ,  $P_{VDD} = 1.65 \text{ V to } 2.0 \text{ V}$ ; operating temperature range, unless otherwise noted. Recommended analog input video signal range: 0.5 V to 1.6 V, typically 1 V p-p.

Table 4.

Parameter <sup>1,2</sup>	Symbol	Test Conditions	Min	Typ	Max	Unit
CLAMP CIRCUITRY						
External Clamp Capacitor		Clamps switched off		0.1		µF
Input Impedance				10		MΩ
Large Clamp Source Current				0.75		mA
Large Clamp Sink Current				0.75		mA
Fine Clamp Source Current				60		µA
Fine Clamp Sink Current				60		µA

<sup>1</sup>Temperature range: T<sub>MIN</sub> to T<sub>MAX</sub>, -40°C to +85°C.

<sup>2</sup>The min/max specifications are guaranteed over this range.



**THERMAL SPECIFICATIONS**

Table 5.

Parameter <sup>1, 2</sup>	Symbol	Test Conditions	Min	Typ	Max	Unit
<b>THERMAL CHARACTERISTICS</b>						
Junction-to-Ambient Thermal Resistance (Still Air)	$\theta_{JA}$	4-layer PCB with solid ground plane, 64-lead LFCSP		45.5		°C/W
Junction-to-Case Thermal Resistance	$\theta_{JC}$	4-layer PCB with solid ground plane, 64-lead LFCSP		9.2		°C/W
Junction-to-Ambient Thermal Resistance (Still Air)	$\theta_{JA}$	4-layer PCB with solid ground plane, 64-lead LQFP		47		°C/W
Junction-to-Case Thermal Resistance	$\theta_{JC}$	4-layer PCB with solid ground plane, 64-lead LQFP		11.1		°C/W

<sup>1</sup>Temperature range:  $T_{MIN}$  to  $T_{MAX}$ , -40°C to +85°C

<sup>2</sup>The min/max specifications are guaranteed over this range.

**TIMING DIAGRAMS**

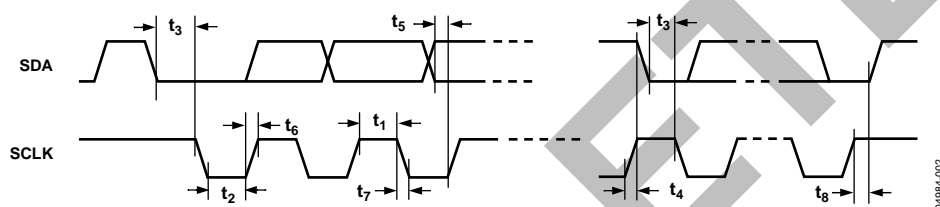

Figure 2. I<sup>2</sup>C Timing

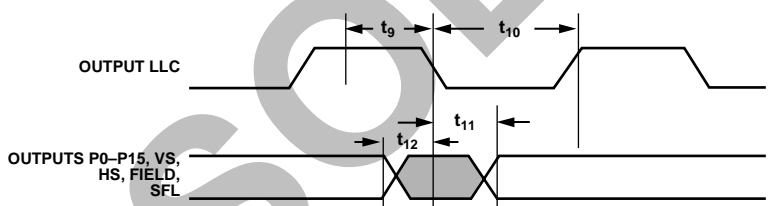

Figure 3. Pixel Port and Control Output Timing

## ABSOLUTE MAXIMUM RATINGS

Table 6.

Parameter	Rating
$A_{VDD}$ to GND	4 V
$A_{VDD}$ to AGND	4 V
$D_{VDD}$ to DGND	2.2 V
$P_{VDD}$ to AGND	2.2 V
$D_{VDDIO}$ to DGND	4 V
$D_{VDDIO}$ to $A_{VDD}$	-0.3 V to +0.3 V
$P_{VDD}$ to $D_{VDD}$	-0.3 V to +0.3 V
$D_{VDDIO} - P_{VDD}$	-0.3 V to +2 V
$D_{VDDIO} - D_{VDD}$	-0.3 V to +2 V
$A_{VDD} - P_{VDD}$	-0.3 V to +2 V
$A_{VDD} - D_{VDD}$	-0.3 V to +2 V
Digital Inputs Voltage to DGND	-0.3 V to $D_{VDDIO} + 0.3$ V
Digital Output Voltage to DGND	-0.3 V to $D_{VDDIO} + 0.3$ V
Analog Inputs to AGND	AGND - 0.3 V to $A_{VDD} + 0.3$ V
Maximum Junction Temperature ( $T_j$ max)	150°C
Storage Temperature Range	-65°C to +150°C
Infrared Reflow Soldering (20 sec)	260°C

Stresses above those listed under Absolute Maximum Ratings may cause permanent damage to the device. This is a stress rating only; functional operation of the device at these or any other conditions above those indicated in the operational section of this specification is not implied. Exposure to absolute maximum rating conditions for extended periods may affect device reliability.

### ESD CAUTION

ESD (electrostatic discharge) sensitive device. Electrostatic charges as high as 4000V readily accumulate on the human body and test equipment and can discharge without detection. Although this product features proprietary ESD protection circuitry, permanent damage may occur on devices subjected to high energy electrostatic discharges. Therefore, proper ESD precautions are recommended to avoid performance degradation or loss of functionality.



# PIN CONFIGURATION AND FUNCTION DESCRIPTIONS

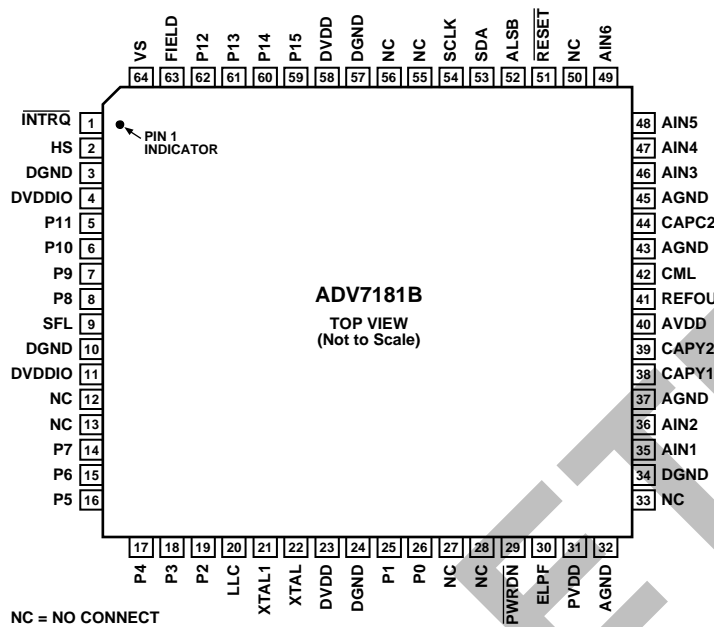

Figure 4. 64-Lead LFCSP/LQFP Pin Configuration

04984-004

# ADV7181B

**Table 7. Pin Function Descriptions**

Pin No.	Mnemonic	Type	Description
3, 10, 24, 34, 57	DGND	G	Digital Ground.
32, 37, 43, 45	AGND	G	Analog Ground.
4, 11	DVDDIO	P	Digital I/O Supply Voltage (3.3 V).
23, 58	DVDD	P	Digital Core Supply Voltage (1.8 V).
40	AVDD	P	Analog Supply Voltage (3.3 V).
31	PVDD	P	PLL Supply Voltage (1.8 V).
35, 36, 46 to 49	AIN1 to AIN6	I	Analog Video Input Channels.
12, 13, 27, 28, 33, 50, 55, 56	NC		No Connect Pins.
5 to 8, 14 to 19, 25, 26, 59 to 62	P0 to P15	O	Video Pixel Output Port.
2	HS	O	Horizontal Synchronization Output Signal.
64	VS	O	Vertical Synchronization Output Signal.
63	FIELD	O	Field Synchronization Output Signal.
1	INTRQ	O	Interrupt Request Output. Interrupt occurs when certain signals are detected on the input video. See the interrupt register map in Table 83.
53	SDA	I/O	I <sup>2</sup> C Port Serial Data Input/Output Pin.
54	SCLK	I	I <sup>2</sup> C Port Serial Clock Input. Maximum clock rate of 400 kHz.
52	ALSB	I	This pin selects the I <sup>2</sup> C address for the ADV7181B. ALSB set to a Logic 0 sets the address for a write as 0x40; for ALSB set to a logic high, the address selected is 0x42.
51	RESET	I	System Reset Input, Active Low. A minimum low reset pulse width of 5 ms is required to reset the ADV7181B circuitry.
20	LLC	O	This is a line-locked output clock for the pixel data output by the ADV7181B. Nominally 27 MHz, but varies up or down according to video line length.
22	XTAL	I	This is the input pin for the 28.6363 MHz crystal, or can be overdriven by an external 3.3 V, 27 MHz clock oscillator source. In crystal mode, the crystal must be a fundamental crystal.
21	XTAL1	O	This pin should be connected to the 28.6363 MHz crystal or left as a no connect if an external 3.3 V, 27 MHz clock oscillator source is used to clock the ADV7181B. In crystal mode, the crystal must be a fundamental crystal.
29	PWRDN	I	A logic low on this pin places the ADV7181B in power-down mode. Refer to the I2C Register Maps section for more options on power-down modes for the ADV7181B.
30	ELPF	I	The recommended external loop filter must be connected to this ELPF pin, as shown in Figure 45.
9	SFL	O	Subcarrier Frequency Lock. This pin contains a serial output stream that can be used to lock the subcarrier frequency when this decoder is connected to any Analog Devices digital video encoder.
41	REFOUT	O	Internal Voltage Reference Output. Refer to Figure 45 for a recommended capacitor network for this pin.
42	CML	O	The CML pin is a common-mode level for the internal ADCs. Refer to Figure 45 for a recommended capacitor network for this pin.
38, 39	CAPY1, CAPY2	I	ADC's Capacitor Network. Refer to Figure 45 for a recommended capacitor network for this pin.
44	CAPC2	I	ADC's Capacitor Network. Refer to Figure 45 for a recommended capacitor network for this pin.

## ANALOG FRONT END

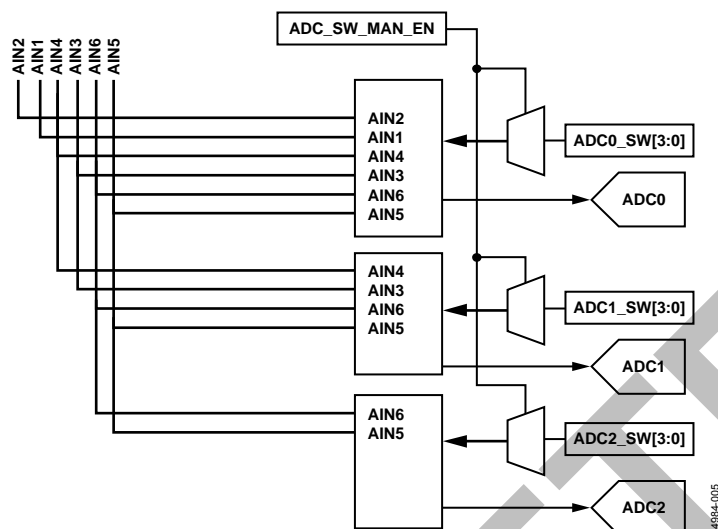

Figure 5. Internal Pin Connections

The two key steps to configure the ADV7181B to correctly decode the input video are:

- The analog input muxing section must be configured to correctly route the video from the analog input pins to the correct set of ADCs.
- The standard definition processor block, which decodes the digital data, should be configured to process either CVBS, YC, or YPrPb.

### ANALOG INPUT MUXING

The ADV7181B has an integrated analog muxing section that allows more than one source of video signal to be connected to the decoder. Figure 5 outlines the overall structure of the input muxing provided in the ADV7181B.

A maximum of six CVBS inputs can be connected and decoded by the ADV7181B. As seen in the Pin Configuration and Function Description section, these analog input pins lie near each other; therefore, a careful design of the PCB layout is required, such as ground shielding between all signals routed through tracks that are physically close together. It is strongly recommended to connect any unused analog input pins to AGND to act as a shield.

#### SETADC\_sw\_man\_en, Manual Input Muxing Enable, Address C4[7]

ADC0\_sw[3:0], ADC0 mux configuration, Address C3[3:0]

ADC1\_sw[3:0], ADC1 mux configuration, Address C3[7:4]

ADC2\_sw[3:0], ADC2 mux configuration, Address C4[3:0]

To configure the ADV7181B analog muxing section, the user must select the analog input (AIN1 to AIN6) that is to be processed by each ADC. SETADC\_sw\_man\_en must be set to 1 to enable the muxing blocks to be configured. The three mux sections are controlled by the signal buses ADC0/1/2\_sw[3:0]. Table 8 explains the control words used.

The input signal that contains the timing information (H/V syncs) must be processed by ADC0. For example, in the YC input configuration, ADC0 should be connected to the Y channel and ADC1 to the C channel. When one or more ADCs are not used to process video, such as CVBS input, the idle ADCs should be powered down (see the ADC Power-Down Control section).

Restrictions on the channel routing are imposed by the analog signal routing inside the IC; it is not possible for each input pin to be routed to each ADC. Refer to Table 8 for an overview on the routing capabilities inside the chip.

# ADV7181B

Table 8. Manual Mux Settings for All ADCs (SETADC\_sw\_man\_en = 1)

ADC0_sw[3:0]	ADC0 Connected to	ADC1_sw[3:0]	ADC1 Connected to	ADC2_sw[3:0]	ADC2 Connected to:
0000	No connection	0000	No connection	0000	No connection
0001	AIN2	0001	No connection	0001	No connection
0010	No connection	0010	No connection	0010	No connection
0011	No connection	0011	No connection	0011	No connection
0100	AIN4	0100	AIN4	0100	No connection
0101	AIN6	0101	AIN6	0101	AIN6
0110	No connection	0110	No connection	0110	No connection
0111	No connection	0111	No connection	0111	No connection
1000	No connection	1000	No connection	1000	No connection
1001	AIN1	1001	No connection	1001	No connection
1010	No connection	1010	No connection	1010	No connection
1011	No connection	1011	No connection	1011	No connection
1100	AIN3	1100	AIN3	1100	No connection
1101	AIN5	1101	AIN5	1101	AIN5
1110	No connection	1110	No connection	1110	No connection
1111	No connection	1111	No connection	1111	No connection

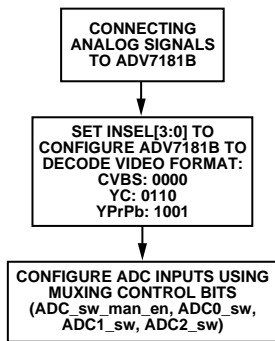

Figure 6. Input Muxing Overview

## INSEL[3:0] Input Selection, Address 0x00[3:0]

The INSEL bits allow the user to select the input format. It configures the standard definition processor core to process CVBS (Comp), S-Video (Y/C), or Component (YPrPb) format.

Table 9. Standard Definition Processor Format Selection, INSEL[3:0]

INSEL[3:0]	Video Format
0000	Composite
0110	Y/C
1001	YPrPb

## GLOBAL CONTROL REGISTERS

Register control bits listed in this section affect the whole chip.

### POWER-SAVE MODES

#### Power-Down

The digital core of the ADV7181B can be shut down by using a pin ( $\overline{\text{PWRDN}}$ ) and a bit ( $\text{PWRDN}$ ); see below. The PDBP controls which of the two has the higher priority. By default, the pin ( $\overline{\text{PWRDN}}$ ) is given priority. This allows the user to have the ADV7181B powered down by default.

#### PDBP, Address 0x0F[2]

When PDBP is 0 (default), the digital core power is controlled by the  $\overline{\text{PWRDN}}$  pin (the bit is disregarded).

When PDBP is 1, the bit has priority (the pin is disregarded).

#### PWRDN, Address 0x0F[5]

Setting the PWRDN bit switches the ADV7181B into a chip-wide power-down mode. The power-down stops the clock from entering the digital section of the chip, thereby freezing its operation. No I<sup>2</sup>C bits are lost during power-down. The PWRDN bit also affects the analog blocks and switches them into low current modes. The I<sup>2</sup>C interface is unaffected and remains operational in power-down mode.

The ADV7181B leaves the power-down state if the PWRDN bit is set to 0 (via I<sup>2</sup>C), or if the overall part is reset using the  $\overline{\text{RESET}}$  pin.

PDBP must be set to 1 for the PWRDN bit to power down the ADV7181B.

When PWRDN is 0 (default), the chip is operational.

When PWRDN is 1, the ADV7181B is in chip-wide power-down.

#### ADC Power-Down Control

The ADV7181B contains three 9-bit ADCs (ADC 0, ADC 1, and ADC 2). If required, it is possible to power down each ADC individually.

The ADCs should be powered down when in:

- CVBS mode. ADC 1 and ADC 2 should be powered down to save on power consumption.
- S-Video mode. ADC 2 should be powered down to save on power consumption.

#### PWRDN\_ADC\_0, Address 0x3A[3]

When PWRDN\_ADC\_0 is 0 (default), the ADC is in normal operation.

When PWRDN\_ADC\_0 is 1, ADC 0 is powered down.

#### PWRDN\_ADC\_1, Address 0x3A[2]

When PWRDN\_ADC\_1 is 0 (default), the ADC is in normal operation.

When PWRDN\_ADC\_1 is 1, ADC 1 is powered down.

#### PWRDN\_ADC\_2, Address 0x3A[1]

When PWRDN\_ADC\_2 is 0 (default), the ADC is in normal operation (default).

When PWRDN\_ADC\_2 is 1, ADC 2 is powered down.

### RESET CONTROL

#### Chip Reset (RES), Address 0x0F[7]

Setting this bit, equivalent to controlling the  $\overline{\text{RESET}}$  pin on the ADV7181B, issues a full chip reset. All I<sup>2</sup>C registers are reset to their default values. Note that some register bits do not have a reset value specified; they keep their last written value. Those bits are marked as having a reset value of x in the register table. After the reset sequence, the part immediately starts to acquire the incoming video signal.

After setting the RES bit (or initiating a reset via the pin), the part returns to the default mode of operation with respect to its primary mode of operation. All I<sup>2</sup>C bits are loaded with their default values, making this bit self-clearing.

Executing a software reset takes approximately 2 ms. However, it is recommended to wait 5 ms before any further I<sup>2</sup>C writes are performed.

The I<sup>2</sup>C master controller receives a no acknowledge condition on the ninth clock cycle when chip reset is implemented. See the MPU Port Description section.

When RES is 0 (default), operation is normal.

When RES is 1, the reset sequence starts.

## GLOBAL PIN CONTROL

### Three-State Output Drivers

**TOD, Address 0x03[6]**

This bit allows the user to three-state the output drivers of the ADV7181B.

Upon setting the TOD bit, the P15 to P0, HS, VS, FIELD, and SFL pins are three-stated.

The timing pins (HS/VS/FIELD) can be forced active via the TIM\_OE bit. For more information on three-state control, refer to the Three-State LLC Driver and the Timing Signals Output Enable sections.

Individual drive strength controls are provided via the DR\_STR\_XX bits.

When TOD is 0 (default), the output drivers are enabled.

When TOD is 1, the output drivers are three-stated.

### Three-State LLC Driver

**TRI\_LLC, Address 0x1D[7]**

This bit allows the output drivers for the LLC pin of the ADV7181B to be three-stated. For more information on three-state control, see the Three-State Output Drivers and the Timing Signals Output Enable sections.

Individual drive strength controls are provided via the DR\_STR\_XX bits.

When TRI\_LLC is 0 (default), the LLC pin drivers work according to the DR\_STR\_C[1:0] setting (pin enabled).

When TRI\_LLC is 1, the LLC pin drivers are three-stated.

### Timing Signals Output Enable

**TIM\_OE, Address 0x04[3]**

The TIM\_OE bit should be regarded as an addition to the TOD bit. Setting it high forces the output drivers for HS, VS, and FIELD into the active (driving) state even if the TOD bit is set. If set to low, the HS, VS, and FIELD pins are three-state dependent on the TOD bit. This functionality is useful if the decoder is to be used as a timing generator only. This may be the case if only the timing signals are to be extracted from an incoming signal, or if the part is in free-run mode where a separate chip can output, for instance, a company logo.

For more information on three-state control, see the Three-State Output Drivers and the Three-State LLC Driver sections.

Individual drive strength controls are provided via the DR\_STR\_XX bits.

When TIM\_OE is 0 (default), HS, VS, and FIELD are three-stated according to the TOD bit.

When TIM\_OE is 1, HS, VS, and FIELD are forced active all the time.

### Drive Strength Selection (Data)

**DR\_STR[1:0] Address 0xF4[5:4]**

For EMC and crosstalk reasons, it can be desirable to strengthen or weaken the drive strength of the output drivers. The DR\_STR[1:0] bits affect the P[15:0] output drivers.

For more information on three-state control, refer to the Drive Strength Selection (Clock) and the Drive Strength Selection (Sync) sections.

**Table 10. DR\_STR Function**

DR_STR[1:0]	Description
00	Low drive strength (1×)
01 (default)	Medium low drive strength (2×)
10	Medium high drive strength (3×)
11	High drive strength (4×)

### Drive Strength Selection (Clock)

**DR\_STR\_C[1:0] Address 0xF4[3:2]**

The DR\_STR\_C[1:0] bits can be used to select the strength of the clock signal output driver (LLC pin). For more information, refer to the Drive Strength Selection (Sync) and the Drive Strength Selection (Data) sections.

**Table 11. DR\_STR\_C Function**

DR_STR[1:0]	Description
00	Low drive strength (1×)
01 (default)	Medium low drive strength (2×)
10	Medium high drive strength (3×)
11	High drive strength (4×)

### Drive Strength Selection (Sync)

**DR\_STR\_S[1:0] Address 0xF4[1:0]**

The DR\_STR\_S[1:0] bits allow the user to select the strength of the synchronization signals with which HS, VS, and F are driven. For more information, refer to the Drive Strength Selection (Data) section.

**Table 12. DR\_STR\_S Function**

DR_STR[1:0]	Description
00	Low drive strength (1×)
01 (default)	Medium low drive strength (2×).
10	Medium high drive strength (3×)
11	High drive strength (4×)



**Enable Subcarrier Frequency Lock Pin****EN\_SFL\_PIN Address 0x04[1]**

The EN\_SFL\_PIN bit enables the output of subcarrier lock information (also known as GenLock) from the ADV7181B core to an encoder in a decoder-encoder back-to-back arrangement.

When EN\_SFL\_PIN is 0 (default), the subcarrier frequency lock output is disabled.

When EN\_SFL\_PIN is 1, the subcarrier frequency lock information is presented on the SFL pin.

**Polarity LLC Pin****PCLK Address 0x37[0]**

The polarity of the clock that leaves the ADV7181B via the LLC pin can be inverted using the PCLK bit.

Changing the polarity of the LLC clock output can be necessary to meet the setup-and-hold time expectations of follow-on chips.

When PCLK is 0, the LLC output polarity is inverted.

When PCLK is 1 (default), the LLC output polarity is normal (as per the timing diagrams).

OBSOLETE

# ADV7181B

## GLOBAL STATUS REGISTERS

Four registers provide summary information about the video decoder. The IDENT register allows the user to identify the revision code of the ADV7181B. The other three registers contain status bits from the ADV7181B.

### IDENTIFICATION

**IDENT[7:0] Address 0x11[7:0]**

The register identification of the revision of the ADV7181B.

An identification value of 0x11 indicates the ADV7181 released silicon.

An identification value of 0x13 indicates the ADV7181B silicon.

### STATUS 1

**STATUS\_1[7:0] Address 0x10[7:0]**

This read-only register provides information about the internal status of the ADV7181B.

See the CIL[2:0] Count Into Lock, Address 0x51[2:0] and the COL[2:0] Count Out-of-Lock, Address 0x51[5:3] sections for information on the timing.

Depending on the setting of the FSCLE bit, the Status 0 and Status 1 are based solely on horizontal timing information or on the horizontal timing and lock status of the color subcarrier. See the FSCLE FSC Lock Enable, Address 0x51[7] section.

### AUTODETECTION RESULT

**AD\_RESULT[2:0] Address 0x10[6:4]**

The AD\_RESULT[2:0] bits report back on the findings from the ADV7181B autodetection block. Consult the General Setup section for more information on enabling the autodetection block, and the Autodetection of SD Modes section to determine how to configure it.

**Table 13. AD\_RESULT Function**

AD_RESULT[2:0]	Description
000	NTSM-MJ
001	NTSC-443
010	PAL-M
011	PAL-60
100	PAL-B/G/H/I/D
101	SECAM
110	PAL-Combination N
111	SECAM 525

**Table 14. STATUS 1 Function**

STATUS 1[7:0]	Bit Name	Description
0	IN_LOCK	In lock (right now).
1	LOST_LOCK	Lost lock (since last read of this register).
2	FSC_LOCK	F <sub>sc</sub> locked (right now).
3	FOLLOW_PW	AGC follows peak white algorithm.
4	AD_RESULT.0	Result of autodetection.
5	AD_RESULT.1	Result of autodetection.
6	AD_RESULT.2	Result of autodetection.
7	COL_KILL	Color kill active.

### STATUS 2

**STATUS\_2[7:0], Address 0x12[7:0]**

**Table 15. STATUS 2 Function**

STATUS 2[7:0]	Bit Name	Description
0	MVCS DET	Detected Macrovision color striping.
1	MVCST3	Macrovision color striping protection. Conforms to Type 3 (if high), and Type 2 (if low).
2	MV_PS DET	Detected Macrovision pseudo sync pulses.
3	MV_AGC DET	Detected Macrovision AGC pulses.
4	LL_NSTD	Line length is nonstandard.
5	FSC_NSTD	F <sub>sc</sub> frequency is nonstandard.
6	Reserved	
7	Reserved	

### STATUS 3

**STATUS\_3[7:0], Address 0x13[7:0]**

**Table 16. STATUS 3 Function**

STATUS 3[7:0]	Bit Name	Description
0	INST_HLOCK	Horizontal lock indicator (instantaneous).
1	GEMD	Gemstar Detect.
2	SD_OP_50HZ	Flags whether 50 Hz or 60 Hz are present at output.
3		Reserved for future use.
4	FREE_RUN_ACT	ADV7181B outputs a blue screen (see the DEF_VAL_EN Default Value Enable, Address 0x0C[0] section).
5	STD_FLD_LEN	Field length is correct for currently selected video standard.
6	INTERLACED	Interlaced video detected (field sequence found).
7	PAL_SW_LOCK	Reliable sequence of swinging bursts detected.

## STANDARD DEFINITION PROCESSOR (SDP)

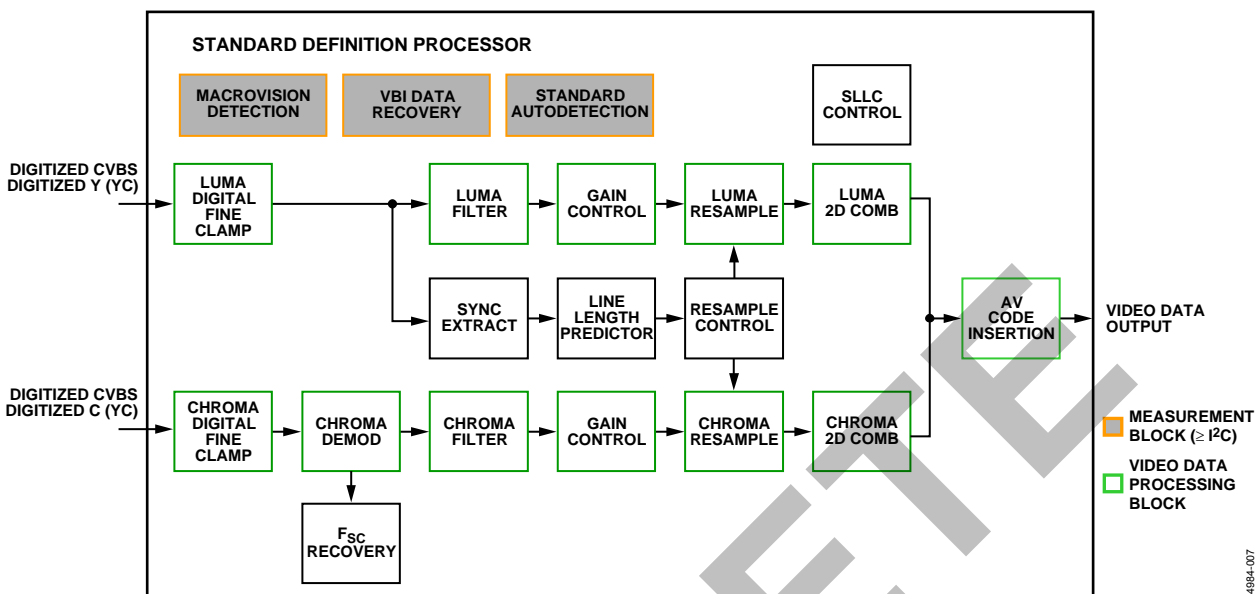

Figure 7. Block Diagram of the Standard Definition Processor

A block diagram of the ADV7181B's standard definition processor (SDP) is shown in Figure 7.

The ADV7181B can handle standard definition video in CVBS, YC, and YPrPb formats. It can be divided into a luminance and chrominance path. If the input video is of a composite type (CVBS), both processing paths are fed with the CVBS input.

### SD LUMA PATH

The input signal is processed by the following blocks:

- Digital Fine Clamp. This block uses a high precision algorithm to clamp the video signal.
- Luma Filter Block. This block contains a luma decimation filter (YAA) with a fixed response, and some shaping filters (YSH) that have selectable responses.
- Luma Gain Control. The automatic gain control (AGC) can operate on a variety of different modes, including gain based on the depth of the horizontal sync pulse, peak white mode, and fixed manual gain.
- Luma Resample. To correct for line-length errors as well as dynamic line-length changes, the data is digitally resampled.
- Luma 2D Comb. The two-dimensional comb filter provides YC separation.
- AV Code Insertion. At this point, the decoded luma (Y) signal is merged with the retrieved chroma values. AV codes (as per ITU-R BT.656) can be inserted.

### SD CHROMA PATH

The input signal is processed by the following blocks:

- Digital Fine Clamp. This block uses a high precision algorithm to clamp the video signal.
- Chroma Demodulation. This block uses a color subcarrier ( $F_{sc}$ ) recovery unit to regenerate the color subcarrier for any modulated chroma scheme. The demodulation block then performs an AM demodulation for PAL and NTSC, and an FM demodulation for SECAM.
- Chroma Filter Block. This block contains a chroma decimation filter (CAA) with a fixed response, and some shaping filters (CSH) that have selectable responses.
- Gain Control. Automatic gain control (AGC) can operate on several different modes, including gain based on the color subcarrier's amplitude, gain based on the depth of the horizontal sync pulse on the luma channel, or fixed manual gain.
- Chroma Resample. The chroma data is digitally resampled to keep it perfectly aligned with the luma data. The resampling is performed to correct for static and dynamic line-length errors of the incoming video signal.
- Chroma 2D Comb. The two-dimensional, 5-line, superadaptive comb filter provides high quality YC separation in case the input signal is CVBS.
- AV Code Insertion. At this point, the demodulated chroma (Cr and Cb) signal is merged with the retrieved luma values. AV codes (as per ITU-R BT.656) can be inserted.

## SYNC PROCESSING

The ADV7181B extracts syncs embedded in the video data stream. There is currently no support for external HS/VS inputs. The sync extraction has been optimized to support imperfect video sources such as VCRs with head switches. The actual algorithm used employs a coarse detection based on a threshold crossing followed by a more detailed detection using an adaptive interpolation algorithm. The raw sync information is sent to a line-length measurement and prediction block. The output of this is then used to drive the digital resampling section to ensure that the ADV7181B outputs 720 active pixels per line.

The sync processing on the ADV7181B also includes the following specialized postprocessing blocks that filter and condition the raw sync information retrieved from the digitized analog video:

- Vsync Processor. This block provides extra filtering of the detected Vsyncs to improve vertical lock.
- Hsync Processor. The Hsync processor is designed to filter incoming Hsyncs that are corrupted by noise, providing much improved performance for video signals with stable time base but poor SNR.

## VBI DATA RECOVERY

The ADV7181B can retrieve the following information from the input video:

- Wide-screen signaling (WSS)
- Copy generation management system (CGMS)
- Closed captioning (CC)
- Macrovision protection presence
- EDTV data
- Gemstar-compatible data slicing

The ADV7181B is also capable of automatically detecting the incoming video standard with respect to

- Color subcarrier frequency
- Field rate
- Line rate

The ADV7181B can configure itself to support PAL-B/G/H/I/D, PAL-M/N, PAL-combination N, NTSC-M, NTSC-J, SECAM 50 Hz/60 Hz, NTSC4.43, and PAL60.

## GENERAL SETUP

### Video Standard Selection

The VID\_SEL[3:0] register allows the user to force the digital core into a specific video standard. Under normal circumstances, this should not be necessary. The VID\_SEL[3:0] bits default to an autodetection mode that supports PAL, NTSC, SECAM, and variants thereof. The Autodetection of SD Modes section provides more information on the autodetection system.

### Autodetection of SD Modes

To guide the autodetect system of the ADV7181B, individual enable bits are provided for each of the supported video standards. Setting the relevant bit to 0 inhibits the standard from being detected automatically. Instead, the system picks the closest of the remaining enabled standards. The results of the autodetection block can be read back via the status registers. See the Global Status Registers section for more information.

VID\_SEL[3:0] Address 0x00[7:4]

Table 17. VID\_SEL Function

VID_SEL[3:0]	Description
0000 (default)	Autodetect (PAL BGHID) <-> NTSC J (no pedestal), SECAM.
0001	Autodetect (PAL BGHID) <-> NTSC M (pedestal), SECAM.
0010	Autodetect (PAL N) (pedestal) <-> NTSC J (no pedestal), SECAM.
0011	Autodetect (PAL N) (pedestal) <-> NTSC M (pedestal), SECAM.
0100	NTSC J (1).
0101	NTSC M (1).
0110	PAL60.
0111	NTSC 4.43 (1).
1000	PAL BGHID.
1001	PAL N = PAL BGHID (with pedestal).
1010	PAL M (without pedestal).
1011	PAL M.
1100	PAL-Combination N.
1101	PAL-Combination N (with pedestal).
1110	SECAM.
1111	SECAM (with pedestal).

### AD\_SEC525\_EN Enable Autodetection of SECAM 525 Line Video, Address 0x07 [7]

Setting AD\_SEC525\_EN to 0 (default) disables the autodetection of a 525-line system with a SECAM style, FM-modulated color component.

Setting AD\_SEC525\_EN to 1 enables the detection.

### AD\_SECAM\_EN Enable Autodetection of SECAM, Address 0x07 [6]

Setting AD\_SECAM\_EN to 0 (default) disables the autodetection of SECAM.

Setting AD\_SECAM\_EN to 1 enables the detection.

### AD\_N443\_EN Enable Autodetection of NTSC 443, Address 0x07 [5]

Setting AD\_N443\_EN to 0 disables the autodetection of NTSC style systems with a 4.43 MHz color subcarrier.

Setting AD\_N443\_EN to 1 (default) enables the detection.

### AD\_P60\_EN Enable Autodetection of PAL60, Address 0x07 [4]

Setting AD\_P60\_EN to 0 disables the autodetection of PAL systems with a 60 Hz field rate.

Setting AD\_P60\_EN to 1 (default) enables the detection.

### AD\_PALN\_EN Enable Autodetection of PAL N, Address 0x07 [3]

Setting AD\_PALN\_EN to 0 (default) disables the detection of the PAL N standard.

Setting AD\_PALN\_EN to 1 enables the detection.

### AD\_PALM\_EN Enable Autodetection of PAL M, Address 0x07 [2]

Setting AD\_PALM\_EN to 0 (default) disables the autodetection of PAL M.

Setting AD\_PALM\_EN to 1 enables the detection.

### AD\_NTSC\_EN Enable Autodetection of NTSC, Address 0x07 [1]

Setting AD\_NTSC\_EN to 0 (default) disables the detection of standard NTSC.

Setting AD\_NTSC\_EN to 1 enables the detection.

### AD\_PAL\_EN Enable Autodetection of PAL, Address 0x07 [0]

Setting AD\_PAL\_EN to 0 (default) disables the detection of standard PAL.

Setting AD\_PAL\_EN to 1 enables the detection.

### SFL\_INV Subcarrier Frequency Lock Inversion

This bit controls the behavior of the PAL switch bit in the SFL (GenLock Telegram) data stream. It was implemented to solve some compatibility issues with video encoders. It solves two problems.

First, the PAL switch bit is only meaningful in PAL. Some encoders (including Analog Devices encoders) also look at the state of this bit in NTSC.

Second, there was a design change in Analog Devices encoders from ADV717x to ADV719x. The older versions used the SFL (GenLock Telegram) bit directly, while the later ones invert the bit prior to using it; this is because the inversion compensated for the 1-line delay of an SFL (GenLock Telegram) transmission.

As a result, ADV717x encoders need the PAL switch bit in the SFL (GenLock Telegram) to be 1 for NTSC to work. Also, ADV7190/ADV7191/ADV7194 encoders need the PAL switch bit in the SFL to be 0 to work in NTSC. If the state of the PAL switch bit is wrong, a 180° phase shift occurs.

In a decoder/encoder back-to-back system in which SFL is used, the bit must be set up properly for the specific encoder used.

### SFL\_INV Function Address 0x41 [6]

Setting SFL\_INV to 0 makes the part SFL-compatible with ADV7190/ADV7191/ADV7194 encoders.

Setting SFL\_INV to 1 (default) makes the part SFL-compatible with ADV717x/ADV7173x encoders.

### Lock-Related Controls

Lock information is presented to the user through Bits[1:0] of the Status 1 register. See the STATUS\_1[7:0] Address 0x10[7:0] section. Figure 8 outlines the signal flow and the controls available to influence the way the lock status information is generated.

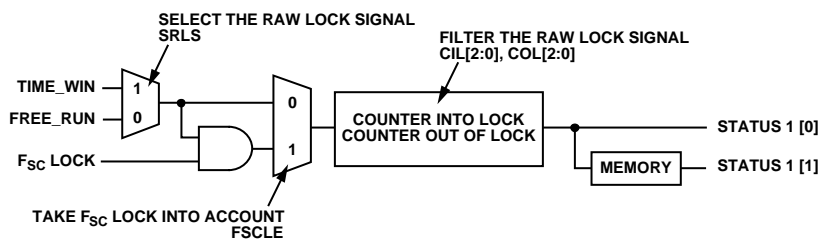

Figure 8. Lock-Related Signal Path

# ADV7181B

## SRLS Select Raw Lock Signal, Address 0x51[6]

Using the SRLS bit, the user can choose between two sources for determining the lock status (per Bits[1:0] in the Status 1 register).

- The time\_win signal is based on a line-to-line evaluation of the horizontal synchronization pulse of the incoming video. It reacts quite quickly.
- The free\_run signal evaluates the properties of the incoming video over several fields, and takes vertical synchronization information into account.

Setting SRLS to 0 (default) selects the free\_run signal.

Setting SRLS to 1 selects the time\_win signal.

## FSCLE F<sub>sc</sub> Lock Enable, Address 0x51[7]

The FSCLE bit allows the user to choose whether the status of the color subcarrier loop is taken into account when the overall lock status is determined and presented via Bits[1:0] in Status Register 1. This bit must be set to 0 when operating the ADV7181B in YPrPb component mode to generate a reliable HLOCK status bit.

When FSCLE is set to 0 (default), the overall lock status is only dependent on horizontal sync lock.

When FSCLE is set to 1, the overall lock status is dependent on horizontal sync lock and F<sub>sc</sub> Lock.

## VS\_COAST[1:0], Address 0xF9[3:2]

These bits are used to set VS free-run (coast) frequency.

**Table 18. VS\_COAST[1:0] Function**

VS_COAST[1:0]	Description
00 (default)	Auto coast mode – follows VS frequency from last video input
01	Forces 50 Hz coast mode
10	Forces 60 Hz coast mode
11	Reserved

## CIL[2:0] Count Into Lock, Address 0x51[2:0]

CIL[2:0] determines the number of consecutive lines for which the lock condition must be true before the system switches into the locked state, and reports this via Status 0[1:0]. It counts the value in lines of video.

**Table 19. CIL Function**

CIL[2:0]	Description
000	1
001	2
010	5
011	10
100 (default)	100
101	500
110	1000
111	100000

## COL[2:0] Count Out-of-Lock, Address 0x51[5:3]

COL[2:0] determines the number of consecutive lines for which the out-of-lock condition must be true before the system switches into unlocked state, and reports this via Status 0[1:0]. It counts the value in lines of video.

**Table 20. COL Function**

COL[2:0]	Description
000	1
001	2
010	5
011	10
100 (default)	100
101	500
110	1000
111	100000

## COLOR CONTROLS

These registers allow the user to control picture appearance, including control of the active data in the event of video being lost. These controls are independent of any other controls. For instance, brightness control is independent from picture clamping, although both controls affect the signal's dc level.

## CON[7:0] Contrast Adjust, Address 0x08[7:0]

This register allows the user to control contrast adjustment of the picture.

**Table 21. CON Function**

CON[7:0]	Description
0x80 (default)	Gain on luma channel = 1
0x00	Gain on luma channel = 0
0xFF	Gain on luma channel = 2

## SD\_SAT\_Cb[7:0] SD Saturation Cb Channel, Address 0xE3[7:0]

This register allows the user to control the gain of the Cb channel only, which in turn adjusts the saturation of the picture.

**Table 22. SD\_SAT\_Cb Function**

SD_SAT_Cb[7:0]	Description
0x80 (default)	Gain on Cb channel = 0 dB
0x00	Gain on Cb channel = -42 dB
0xFF	Gain on Cb channel = +6 dB

**SD\_SAT\_Cr[7:0] SD Saturation Cr Channel, Address 0xE4[7:0]**

This register allows the user to control the gain of the Cr channel only, which in turn adjusts the saturation of the picture.

**Table 23. SD\_SAT\_Cr Function**

SD_SAT_Cr[7:0]	Description
0x80 (default)	Gain on Cr channel = 0 dB
0x00	Gain on Cb channel = -42 dB
0xFF	Gain on Cb channel = +6 dB

**SD\_OFF\_Cb[7:0] SD Offset Cb Channel, Address 0xE1[7:0]**

This register allows the user to select an offset for the Cb channel only and adjust the hue of the picture. There is a functional overlap with the Hue[7:0] register.

**Table 24. SD\_OFF\_Cb Function**

SD_OFF_Cb[7:0]	Description
0x80 (default)	0 offset applied to the Cb channel
0x00	-312 mV offset applied to the Cb channel
0xFF	+312 mV offset applied to the Cb channel

**SD\_OFF\_Cr[7:0] SD Offset Cr Channel, Address 0xE2[7:0]**

This register allows the user to select an offset for the Cr channel only and adjust the hue of the picture. There is a functional overlap with the Hue[7:0] register.

**Table 25. SD\_OFF\_Cr Function**

SD_OFF_Cr[7:0]	Description
0x80 (default)	0 offset applied to the Cr channel
0x00	-312 mV offset applied to the Cr channel
0xFF	+312 mV offset applied to the Cr channel

**BRI[7:0] Brightness Adjust, Address 0x0A[7:0]**

This register controls the brightness of the video signal. It allows the user to adjust the brightness of the picture.

**Table 26. BRI Function**

BRI[7:0]	Description
0x00 (default)	Offset of the luma channel = 0IRE
0x7F	Offset of the luma channel = +100IRE
0x80	Offset of the luma channel = -100IRE

**HUE[7:0] Hue Adjust, Address 0x0B[7:0]**

This register contains the value for the color hue adjustment. It allows the user to adjust the hue of the picture.

HUE[7:0] has a range of  $\pm 90^\circ$ , with 0x00 equivalent to an adjustment of  $0^\circ$ . The resolution of HUE[7:0] is 1 bit =  $0.7^\circ$ .

The hue adjustment value is fed into the AM color demodulation block. Therefore, it applies only to video signals that contain chroma information in the form of an AM-modulated carrier (CVBS or Y/C in PAL or NTSC). It does not affect SECAM and does not work on component video inputs (YPrPb).

**Table 27. HUE Function**

HUE[7:0]	Description (Adjust Hue of the Picture)
0x00 (default)	Phase of the chroma signal = $0^\circ$
0x7F	Phase of the chroma signal = $-90^\circ$
0x80	Phase of the chroma signal = $+90^\circ$

**DEF\_Y[5:0] Default Value Y, Address 0x0C[7:2]**

When the ADV7181B loses lock on the incoming video signal or when there is no input signal, the DEF\_Y[5:0] register allows the user to specify a default luma value to be output. This value is used under the following conditions:

- If DEF\_VAL\_AUTO\_EN bit is set to high and the ADV7181B lost lock to the input video signal. This is the intended mode of operation (automatic mode).
- The DEF\_VAL\_EN bit is set, regardless of the lock status of the video decoder. This is a forced mode that may be useful during configuration.

The DEF\_Y[5:0] values define the 6 MSBs of the output video. The remaining LSBs are padded with 0s. For example, in 8-bit mode, the output is  $Y[7:0] = \{\text{DEF\_Y}[5:0], 0, 0\}$ .

DEF\_Y[5:0] is 0x0D (blue) is the default value for Y.

Register 0x0C has a default value of 0x36.

**DEF\_C[7:0] Default Value C, Address 0x0D[7:0]**

The DEF\_C[7:0] register complements the DEF\_Y[5:0] value. It defines the 4 MSBs of Cr and Cb values to be output if

- The DEF\_VAL\_AUTO\_EN bit is set high and the ADV7181B cannot lock to the input video (automatic mode).
- DEF\_VAL\_EN bit is set to high (forced output).

The data that is finally output from the ADV7181B for the chroma side is  $\text{Cr}[7:0] = \{\text{DEF\_C}[7:4], 0, 0, 0, 0\}$ ,  $\text{Cb}[7:0] = \{\text{DEF\_C}[3:0], 0, 0, 0, 0\}$ .

DEF\_C[7:0] is 0x7C (blue) is the default value for Cr and Cb.

# ADV7181B

## DEF\_VAL\_EN Default Value Enable, Address 0x0C[0]

This bit forces the use of the default values for Y, Cr, and Cb. Refer to the descriptions for DEF\_Y and DEF\_C for additional information. In this mode, the decoder also outputs a stable 27 MHz clock, HS, and VS.

Setting DEF\_VAL\_EN to 0 (default) outputs a colored screen determined by user-programmable Y, Cr, and Cb values when the decoder free-runs. Free-run mode is turned on and off by the DEF\_VAL\_AUTO\_EN bit.

Setting DEF\_VAL\_EN to 1 forces a colored screen output determined by user-programmable Y, Cr, and Cb values. This overrides picture data even if the decoder is locked.

## DEF\_VAL\_AUTO\_EN Default Value Automatic Enable, Address 0x0C[1]

This bit enables the automatic use of the default values for Y, Cr, and Cb when the ADV7181B cannot lock to the video signal.

Setting DEF\_VAL\_AUTO\_EN to 0 disables free-run mode. If the decoder is unlocked, it outputs noise.

Setting DEF\_VAL\_EN to 1 (default) enables free-run mode, and a colored screen set by user-programmable Y, Cr and Cb values is displayed when the decoder loses lock.

## CLAMP OPERATION

The input video is ac-coupled into the ADV7181B through a 0.1  $\mu\text{F}$  capacitor. It is recommended that the input video signal range be 0.5 V to 1.6 V (typically 1 V p-p). If the signal exceeds this range, it cannot be processed correctly in the decoder. Because the input signal is ac-coupled into the decoder, its dc value needs to be restored. This process is referred to as clamping the video. This section explains the general process of clamping on the ADV7181B and shows the different ways in which a user can configure its behavior.

The ADV7181B uses a combination of current sources and a digital processing block for clamping, as shown in Figure 9. The analog processing channel shown is replicated three times inside the IC. While only one single channel (and only one ADC) is needed for a CVBS signal, two independent channels are needed for YC (S-VHS) type signals, and three independent channels are needed to allow component signals (YPrPb) to be processed.

The clamping can be divided into two sections

- Clamping before the ADC (analog domain): current sources.
- Clamping after the ADC (digital domain): digital processing block.

The ADCs can digitize an input signal only if it resides within the ADC's 1.6 V input voltage range. An input signal with a dc level that is too large or too small is clipped at the top or bottom of the ADC range.

The primary task of the analog clamping circuits is to ensure that the video signal stays within the valid ADC input window so the analog-to-digital conversion can take place. It is not necessary to clamp the input signal with a very high accuracy in the analog domain as long as the video signal fits the ADC range.

After digitization, the digital fine clamp block corrects for any remaining variations in dc level. Since the dc level of an input video signal refers directly to the brightness of the picture transmitted, it is important to perform a fine clamp with high accuracy; otherwise, brightness variations can occur. Furthermore, dynamic changes in the dc level almost certainly lead to visually objectionable artifacts and must therefore be prohibited.

The clamping scheme has to complete two tasks. It must be able to acquire a newly connected video signal with a completely unknown dc level, and it must maintain the dc level during normal operation.

For quickly acquiring an unknown video signal, the large current clamps can be activated. It is assumed that the amplitude of the video signal at this point is of a nominal value. Control of the coarse and fine current clamp parameters is performed automatically by the decoder.

Standard definition video signals can have excessive noise on them. In particular, CVBS signals transmitted by terrestrial broadcast and demodulated using a tuner usually show very large levels of noise (>100 mV). A voltage clamp would be unsuitable for this type of video signal. Instead, the ADV7181B uses a set of four current sources that can cause coarse (>0.5 mA) and fine (<0.1 mA) currents to flow into and away from the high impedance node that carries the video signal (see Figure 9).

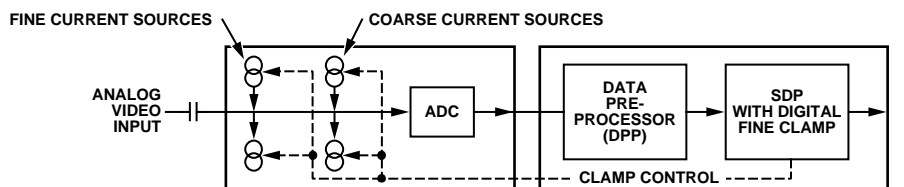

Figure 9. Clamping Overview



The following sections describe the I<sup>2</sup>C signals that can be used to influence the behavior of the clamping block.

Previous revisions of the ADV7181B had controls (FACL/FICL, fast and fine clamp length) to allow configuration of the length for which the coarse (fast) and fine current sources are switched on. These controls were removed on the ADV7181-FT and replaced by an adaptive scheme.

#### CCLEN Current Clamp Enable, Address 0x14[4]

The current clamp enable bit allows the user to switch off the current sources in the analog front end altogether. This can be useful if the incoming analog video signal is clamped externally.

When CCLEN is 0, the current sources are switched off.

When CCLEN is 1 (default), the current sources are enabled.

#### DCT[1:0] Digital Clamp Timing, Address 0x15[6:5]

The clamp timing register determines the time constant of the digital fine clamp circuitry. It is important to realize that the digital fine clamp reacts very quickly because it is supposed to immediately correct any residual dc level error for the active line. The time constant of the digital fine clamp must be much quicker than the one from the analog blocks.

By default, the time constant of the digital fine clamp is adjusted dynamically to suit the currently connected input signal.

**Table 28. DCT Function**

DCT[1:0]	Description
00	Slow (TC = 1 sec)
01	Medium (TC = 0.5 sec)
10 (default)	Fast (TC = 0.1 sec)
11	Determined by ADV7181B, depending on the input video parameters

#### DCFE Digital Clamp Freeze Enable, Address 0x15[4]

This register bit allows the user to freeze the digital clamp loop at any time. It is intended for users who would like to do their own clamping. Users should disable the current sources for analog clamping via the appropriate register bits, wait until the digital clamp loop settles, and then freeze it via the DCFE bit.

When DCFE is 0 (default), the digital clamp is operational.

When DCFE is 1, the digital clamp loop is frozen.

## LUMA FILTER

Data from the digital fine clamp block is processed by three sets of filters. The data format at this point is CVBS for CVBS input or luma only for Y/C and YPrPb input formats.

- Luma Antialias Filter (YAA). The ADV7181B receives video at a rate of 27 MHz. (In the case of 4× oversampled video, the ADCs sample at 54 MHz, and the first decimation is performed inside the DPP filters. Therefore, the data rate into the ADV7181B is always 27 MHz.) The ITU-R BT.601 recommends a sampling frequency of 13.5 MHz. The luma antialias filter decimates the oversampled video using a high quality, linear phase, low-pass filter that preserves the luma signal while at the same time attenuating out-of-band components. The luma antialias filter (YAA) has a fixed response.
- Luma Shaping Filters (YSH). The shaping filter block is a programmable low-pass filter with a wide variety of responses. It can be used to selectively reduce the luma video signal bandwidth (needed prior to scaling, for example). For some video sources that contain high frequency noise, reducing the bandwidth of the luma signal improves visual picture quality. A follow-on video compression stage can work more efficiently if the video is low-pass filtered.

The ADV7181B has two responses for the shaping filter: one that is used for good quality CVBS, component, and S-VHS type sources, and a second for nonstandard CVBS signals.

The YSH filter responses also include a set of notches for PAL and NTSC. However, it is recommended to use the comb filters for YC separation.

- Digital Resampling Filter. This block is used to allow dynamic resampling of the video signal to alter parameters such as the time base of a line of video. Fundamentally, the resampler is a set of low-pass filters. The actual response is chosen by the system with no requirement for user intervention.

Figure 11 through Figure 14 show the overall response of all filters together. Unless otherwise noted, the filters are set into a typical wideband mode.

## Y-Shaping Filter

For input signals in CVBS format, the luma shaping filters play an essential role in removing the chroma component from a composite signal. YC separation must aim for the best possible crosstalk reduction while still retaining as much bandwidth (especially on the luma component) as possible. High quality YC separation can be achieved by using the internal comb filters of the ADV7181B. Comb filtering, however, relies on the frequency relationship of the luma component (multiples of the video line rate) and the color subcarrier (Fsc). For good quality CVBS signals, this relationship is known; the comb filter algorithms can be used to separate out luma and chroma with high accuracy.

With nonstandard video signals, the frequency relationship can be disturbed and the comb filters may not be able to remove all crosstalk artifacts in an optimum fashion without the assistance of the shaping filter block.

An automatic mode is provided. Here, the ADV7181B evaluates the quality of the incoming video signal and selects the filter responses in accordance with the signal quality and video standard. YFSM, WYSFMOVR, and WYSFM allow the user to manually override the automatic decisions in part or in full.

The luma shaping filter has three control registers:

- YFSM[4:0] allows the user to manually select a shaping filter mode (applied to all video signals) or to enable an automatic selection (dependent on video quality and video standard).
- WYSFMOVR allows the user to manually override the WYSFM decision.
- WYSFM[4:0] allows the user to select a different shaping filter mode for good quality CVBS, component (YPrPb), and S-VHS (YC) input signals.

In automatic mode, the system preserves the maximum possible bandwidth for good CVBS sources (since they can successfully be combed) as well as for luma components of YPrPb and YC sources, since they need not be combed. For poor quality signals, the system selects from a set of proprietary shaping filter responses that complements comb filter operation to reduce visual artifacts.

The decisions of the control logic are shown in Figure 10.

### YFSM[4:0] Y-Shaping Filter Mode, Address 0x17[4:0]

The Y-shaping filter mode bits allow the user to select from a wide range of low-pass and notch filters. When switched in automatic mode, the filter is selected based on other register selections, such as detected video standard, and also certain properties extracted from the incoming video itself, such as quality and time-base stability. The automatic selection always picks the widest possible bandwidth for the video input encountered.

- If the YFSM settings specify a filter (such as, YFSM is set to values other than 00000 or 00001), the chosen filter is applied to all video, regardless of its quality.
- In automatic selection mode, the notch filters are only used for bad quality video signals. For all other video signals, wideband filters are used.

### WYSFMOVR Wideband Y-Shaping Filter Override, Address 0x18[7]

Setting the WYSFMOVR bit enables the use of the WYSFM[4:0] settings for good quality video signals. For more information, refer to the general discussion of the luma shaping filters in the Y-Shaping Filter section and the flowchart shown in Figure 10.

When WYSFMOVR is 0, the shaping filter for good quality video signals is selected automatically.

Setting WYSFMOVR to 1 (default) enables manual override via WYSFM[4:0].

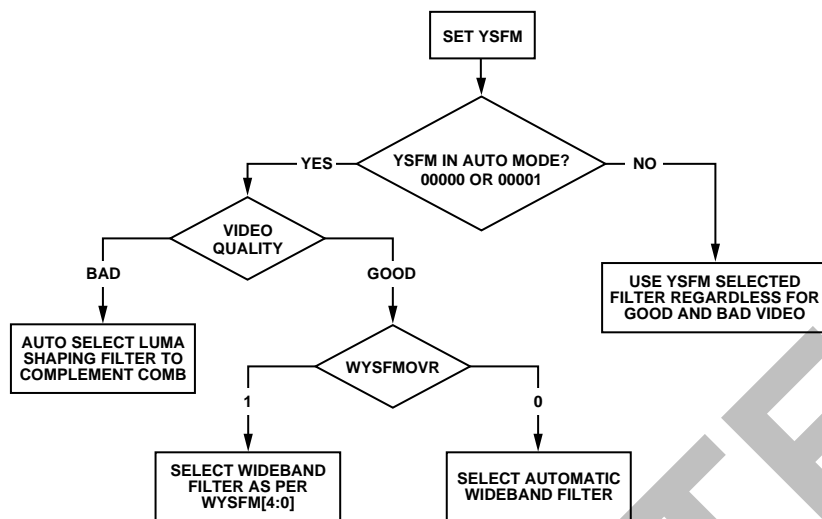

Figure 10. YSFM and WYSFM Control Flowchart

Table 29. YSFM Function

YSFM[4:0]	Description
0'0000	Automatic selection including a wide notch response (PAL/NTSC/SECAM)
0'0001 (default)	Automatic selection including a narrow notch response (PAL/NTSC/SECAM)
0'0010	SVHS 1
0'0011	SVHS 2
0'0100	SVHS 3
0'0101	SVHS 4
0'0110	SVHS 5
0'0111	SVHS 6
0'1000	SVHS 7
0'1001	SVHS 8
0'1010	SVHS 9
0'1011	SVHS 10
0'1100	SVHS 11
0'1101	SVHS 12
0'1110	SVHS 13
0'1111	SVHS 14
1'0000	SVHS 15
1'0001	SVHS 16
1'0010	SVHS 17
1'0011	SVHS 18 (CCIR 601)
1'0100	PAL NN 1
1'0101	PAL NN 2
1'0110	PAL NN 3
1'0111	PAL WN 1
1'1000	PAL WN 2
1'1001	NTSC NN 1
1'1010	NTSC NN 2
1'1011	NTSC NN 3
1'1100	NTSC WN 1
1'1101	NTSC WN 2
1'1110	NTSC WN 3
1'1111	Reserved

**WYSFM[4:0] Wideband Y Shaping Filter Mode, Address 0x18[4:0]**

The WYSFM[4:0] bits allow the user to manually select a shaping filter for good quality video signals, for example, CVBS with stable time base, luma component of YPrPb, luma component of YC. The WYSFM bits are active only if the WYSFMOVR bit is set to 1. See the general discussion of the shaping filter settings in the Y-Shaping Filter section.

Table 30. WYSFM Function

WYSFM[4:0]	Description
0'0000	Do not use
0'0001	Do not use
0'0010	SVHS 1
0'0011	SVHS 2
0'0100	SVHS 3
0'0101	SVHS 4
0'0110	SVHS 5
0'0111	SVHS 6
0'1000	SVHS 7
0'1001	SVHS 8
0'1010	SVHS 9
0'1011	SVHS 10
0'1100	SVHS 11
0'1101	SVHS 12
0'1110	SVHS 13
0'1111	SVHS 14
1'0000	SVHS 15
1'0001	SVHS 16
1'0010	SVHS 17
1'0011 (default)	SVHS 18 (CCIR 601)
1'0100 to 1'1111	Do not use

The filter plots in Figure 11 show the S-VHS 1 (narrowest) to S-VHS 18 (widest) shaping filter settings. Figure 13 shows the PAL notch filter responses. The NTSC-compatible notches are shown in Figure 14.

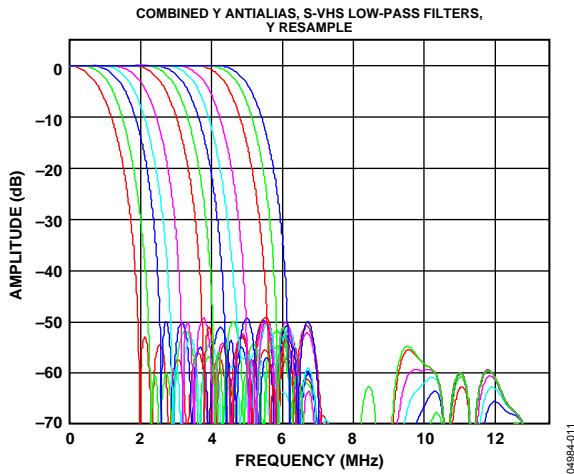

Figure 11. YS-VHS Combined Responses

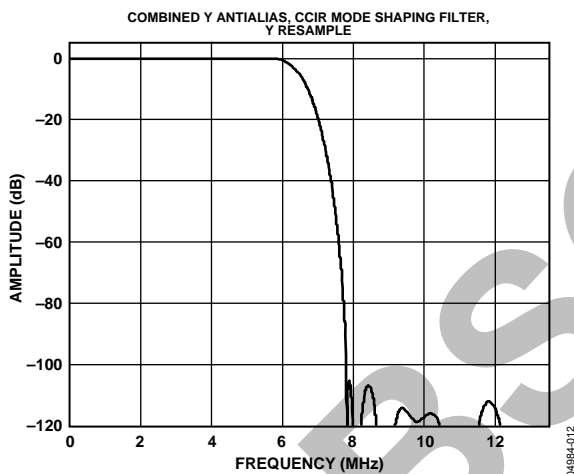

Figure 12. Y S-VHS 18 Extra Wideband Filter (CCIR 601 Compliant)

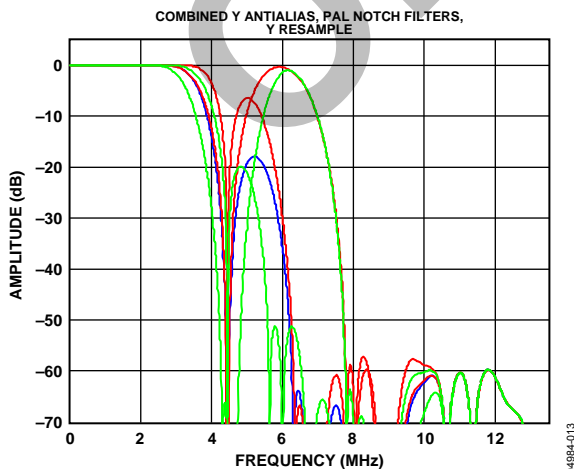

Figure 13. Pal Notch Filter Response

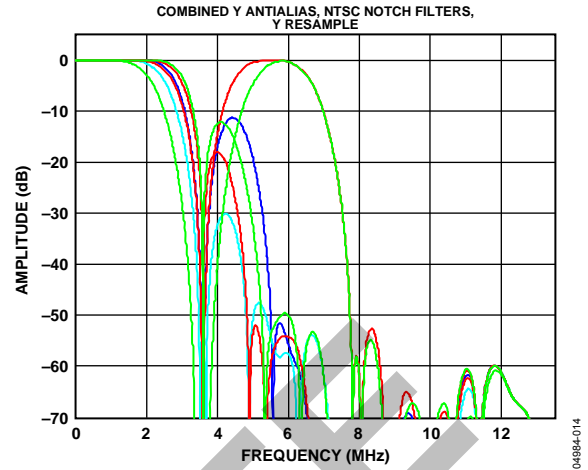

Figure 14. NTSC Notch Filter Response

## CHROMA FILTER

Data from the digital fine clamp block is processed by three sets of filters. The data format at this point is CVBS for CVBS inputs, chroma only for Y/C, or U/V interleaved for YPrPb input formats.

- Chroma Antialias Filter (CAA). The ADV7181B oversamples the CVBS by a factor of 2 and the Chroma/PrPb by a factor of 4. A decimating filter (CAA) is used to preserve the active video band and to remove any out-of-band components. The CAA filter has a fixed response.
- Chroma Shaping Filters (CSH). The shaping filter block (CSH) can be programmed to perform a variety of low-pass responses. It can be used to selectively reduce the bandwidth of the chroma signal for scaling or compression.
- Digital Resampling Filter. This block is used to allow dynamic resampling of the video signal to alter parameters such as the time base of a line of video. Fundamentally, the resampler is a set of low-pass filters. The actual response is chosen by the system without user intervention.

The plots in Figure 15 show the overall response of all filters together.

## CSFM[2:0] C Shaping Filter Mode, Address 0x17[7]

The C shaping filter mode bits allow the user to select from a range of low-pass filters, SH1 to SH5 and wideband mode, for the chrominance signal. The autoselection options automatically select from the filter options to give the specified response; see settings 000 and 001 in Table 31.

**Table 31. CSFM Function**

CSFM[2:0]	Description
000 (default)	Autoselect 1.5 MHz bandwidth
001	Autoselect 2.17 MHz bandwidth
010	SH1
011	SH2
100	SH3
101	SH4
110	SH5
111	Wideband mode

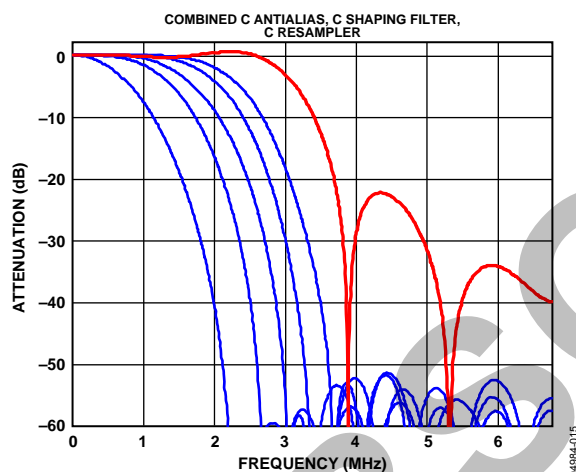

Figure 15. Chroma Shaping Filter Responses

Figure 15 shows the responses of SH1 (narrowest) to SH5 (widest) in addition to the wideband mode (in red).

## GAIN OPERATION

The gain control within the ADV7181B is done on a purely digital basis. The input ADCs support a 9-bit range, mapped into a 1.6 V analog voltage range. Gain correction takes place after the digitization in the form of a digital multiplier.

Advantages of this architecture over the commonly used programmable gain amplifier (PGA) before the ADC include the fact that the gain is now completely independent of supply, temperature, and process variations.

As shown in Figure 16, the ADV7181B can decode a video signal as long as it fits into the ADC window. The components to this are the amplitude of the input signal and the dc level it resides on. The dc level is set by the clamping circuitry (see the Clamp Operation section).

If the amplitude of the analog video signal is too high, clipping can occur, resulting in visual artifacts. The analog input range of the ADC, together with the clamp level, determines the maximum supported amplitude of the video signal.

The minimum supported amplitude of the input video is determined by the ADV7181B's ability to retrieve horizontal and vertical timing and to lock to the color burst, if present.

There are separate gain control units for luma and chroma data. Both can operate independently of each other. The chroma unit, however, can also take its gain value from the luma path.

The possible AGC modes are summarized in Table 32.

It is possible to freeze the automatic gain control loops. This causes the loops to stop updating. It also causes the AGC determined gain at the time of the freeze to stay active until the loop is either unfrozen or the gain mode of operation is changed.

The currently active gain from any of the modes can be read back. Refer to the description of the dual-function manual gain registers, LG[11:0] Luma Gain and CG[11:0] Chroma Gain, in the Luma Gain and the Chroma Gain sections.

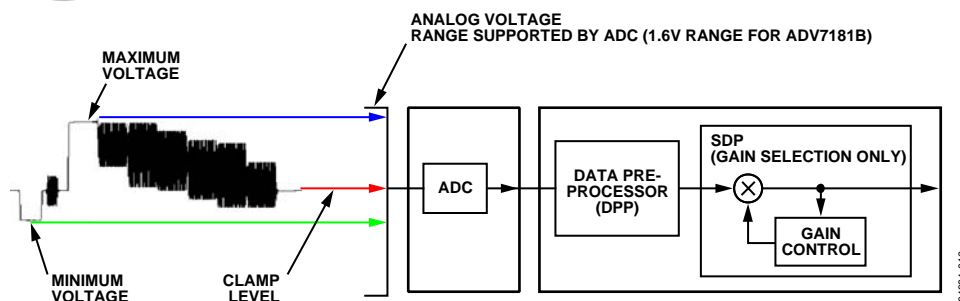

Figure 16. Gain Control Overview

# ADV7181B

**Table 32. AGC Modes**

Input Video Type	Luma Gain	Chroma Gain
Any	Manual gain luma	Manual gain chroma
CVBS	Dependent on horizontal sync depth  Peak white	Dependent on color burst amplitude; taken from luma path Dependent on color burst amplitude; taken from luma path
Y/C	Dependent on horizontal sync depth  Peak white	Dependent on color burst amplitude; taken from luma path Dependent on color burst amplitude; taken from luma path
YPrPb	Dependent on horizontal sync depth	Taken from luma path

## Luma Gain

### LAGC[2:0] Luma Automatic Gain Control, Address 0x2C[7:0]

The luma automatic gain control mode bits select the mode of operation for the gain control in the luma path.

There are ADI internal parameters to customize the peak white gain control. Contact ADI sales for more information.

**Table 33. LAGC Function**

LAGC[2:0]	Description
000	Manual fixed gain (use LMG[11:0])
001	AGC (blank level to sync tip); peak white algorithm off
010 (default)	AGC (blank level to sync tip); peak white algorithm on
011	Reserved
100	Reserved
101	Reserved
110	Reserved
111	Freeze gain

### LAGT[1:0] Luma Automatic Gain Timing, Address 0x2F[7:6]

The luma automatic gain timing register allows the user to influence the tracking speed of the luminance automatic gain control. This register only has an effect if the LAGC[2:0] register is set to 001, 010, 011, or 100 (automatic gain control modes).

If peak white AGC is enabled and active (see the STATUS\_1[7:0] Address 0x10[7:0] section), the actual gain update speed is dictated by the peak white AGC loop and, as a result, the LAGT settings have no effect. As soon as the part leaves peak white AGC, LAGT becomes relevant again.

The update speed for the peak white algorithm can be customized by the use of internal parameters. Contact ADI sales for more information.

**Table 34. LAGT Function**

LAGT[1:0]	Description
00	Slow (TC = 2 sec)
01	Medium (TC = 1 sec)
10	Fast (TC = 0.2 sec)
11 (default)	Adaptive

### LG[11:0] Luma Gain, Address 0x2F[3:0]; Address 0x30[7:0]; LMG[11:0] Luma Manual Gain, Address 0x2F[3:0]; Address 0x30[7:0]

Luma gain[11:0] is a dual-function register. If written to, a desired manual luma gain can be programmed. This gain becomes active if the LAGC[2:0] mode is switched to manual fixed gain. Equation 1 shows how to calculate a desired gain.

If read back, this register returns the current gain value. Depending on the setting in the LAGC[2:0] bits, one of these gain values is returned:

- Luma manual gain value (LAGC[2:0] set to luma manual gain mode)
- Luma automatic gain value (LAGC[2:0] set to any of the automatic modes)

**Table 35. LG/LMG Function**

LG[11:0]/LMG[11:0]	Read/Write	Description
LMG[11:0] = X	Write	Manual gain for luma path
LG[11:0]	Read	Actually used gain

$$Luma\_Gain = \frac{(0 < LG \leq 4095)}{2048} = 0...2 \quad (1)$$

For example, program the ADV7181B into manual fixed gain mode with a desired gain of 0.89.

1. Use Equation 1 to convert the gain:  
 $0.89 \times 2048 = 1822.72$
2. Truncate to integer value:  
 $1822.72 = 1822$
3. Convert to hexadecimal:  
 $1822d = 0x71E$
4. Split into two registers and program:  
Luma Gain Control 1[3:0] = 0x7  
Luma Gain Control 2[7:0] = 0x1E
5. Enable manual fixed gain mode:  
Set LAGC[2:0] to 000

**BETCAM Enable Betacam Levels, Address 0x01[5]**

If YPrPb data is routed through the ADV7181B, the automatic gain control modes can target different video input levels, as outlined in Table 39. The BETACAM bit is valid only if the input mode is YPrPb (component). The BETACAM bit basically sets the target value for AGC operation.

A review of the following sections is useful:

- SETADC\_sw\_man\_en, Manual Input Muxing Enable, Address C4[7] to find how component video (YPrPb) can be routed through the ADV7181B.
- Video Standard Selection to select the various standards, for example, with and without pedestal.

The automatic gain control (AGC) algorithms adjust the levels based on the setting of the BETACAM bit (see Table 36).

**Table 36. BETACAM Function**

BETACAM	Description
0 (default)	Assuming YPrPb is selected as input format Selecting PAL with pedestal selects MII Selecting PAL without pedestal selects SMPTE Selecting NTSC with pedestal selects MII Selecting NTSC without pedestal selects SMPTE
1	Assuming YPrPb is selected as input format Selecting PAL with pedestal selects BETACAM Selecting PAL without pedestal selects BETACAM variant Selecting NTSC with pedestal selects BETACAM Selecting NTSC without pedestal selects BETACAM variant

**Table 39. Betacam Levels**

Name	Betacam (mV)	Betacam Variant (mV)	SMPTE (mV)	MIl (mV)
Y Range	0 to 714 (includes 7.5% pedestal)	0 to 714	0 to 700	0 to 700 (includes 7.5% pedestal)
Pb and Pr Range	-467 to +467	-505 to +505	-350 to +350	-324 to +324
Sync Depth	286	286	300	300

**PW\_UPD Peak White Update, Address 0x2B[0]**

The peak white and average video algorithms determine the gain based on measurements taken from the active video. The PW\_UPD bit determines the rate of gain change. LAGC[2:0] must be set to the appropriate mode to enable the peak white or average video mode in the first place. For more information, refer to the LAGC[2:0] Luma Automatic Gain Control, Address 0x2C[7:0] section.

Setting PW\_UPD to 0 updates the gain once per video line.

Setting PW\_UPD to 1 (default) updates the gain once per field.

**Chroma Gain**

**CAGC[1:0] Chroma Automatic Gain Control, Address 0x2C[1:0]**

The two bits of color automatic gain control mode select the basic mode of operation for automatic gain control in the chroma path.

**Table 37. CAGC Function**

CAGC[1:0]	Description
00	Manual fixed gain (use CMG[11:0])
01	Use luma gain for chroma
10 (default)	Automatic gain (based on color burst)
11	Freeze chroma gain

**CAGT[1:0] Chroma Automatic Gain Timing, Address 0x2D[7:6]**

The chroma automatic gain timing register allows the user to influence the tracking speed of the chroma automatic gain control. This register has an effect only if the CAGC[1:0] register is set to 10 (automatic gain).

**Table 38. CAGT Function**

CAGT[1:0]	Description
00	Slow (TC = 2 sec)
01	Medium (TC = 1 sec)
10	Fast (TC = 0.2 sec)
11 (default)	Adaptive

**CG[11:0] Chroma Gain, Address 0x2D[3:0];  
Address 0x2E[7:0]; CMG[11:0] Chroma Manual Gain,  
Address 0x2D[3:0]; Address 0x2E[7:0]**

Chroma gain[11:0] is a dual-function register. If written to, a desired manual chroma gain can be programmed. This gain becomes active if the CAGC[1:0] mode is switched to manual fixed gain. Refer to Equation 2 for calculating a desired gain.

If read back, this register returns the current gain value. Depending on the setting in the CAGC[1:0] bits, this is either

- Chroma manual gain value (CAGC[1:0] set to chroma manual gain mode).
- Chroma automatic gain value (CAGC[1:0] set to any of the automatic modes).

**Table 40. CG/CMG Function**

CG[11:0]/CMG[11:0]	Read/Write	Description
CMG[11:0]	Write	Manual gain for chroma path
CG[11:0]	Read	Currently active gain

$$Chroma\_Gain = \frac{(0 < CG \leq 4095)}{1024} = 0...4 \quad (2)$$

For example, freezing the automatic gain loop and reading back the CG[11:0] register results in a value of 0x47A.

1. Convert the readback value to decimal  
0x47A = 1146d
2. Apply Equation 2 to convert the readback value  
1146/1024 = 1.12

**CKE Color Kill Enable, Address 0x2B[6]**

The color kill enable bit allows the optional color kill function to be switched on or off.

For QAM-based video standards (PAL and NTSC) and FM-based systems (SECAM), the threshold for the color kill decision is selectable via the CKILLTHR[2:0] bits.

If color kill is enabled, and if the color carrier of the incoming video signal is less than the threshold for 128 consecutive video lines, color processing is switched off (black and white output). To switch the color processing back on, another 128 consecutive lines with a color burst greater than the threshold are required.

The color kill option works only for input signals with a modulated chroma part. For component input (YPrPb), there is no color kill.

Setting CKE to 0 disables color kill.

Setting CKE to 1 (default) enables color kill.

**CKILLTHR[2:0] Color Kill Threshold,  
Address 0x3D[6:4]**

The CKILLTHR[2:0] bits allow the user to select a threshold for the color kill function. The threshold applies to only QAM-based (NTSC and PAL) or FM-modulated (SECAM) video standards.

To enable the color kill function, the CKE bit must be set. For settings 000, 001, 010, and 011, chroma demodulation inside the ADV7181B may not work satisfactorily for poor input video signals.

**Table 41. CKILLTHR Function**

CKILLTHR[2:0]	Description	
	SECAM	NTSC, PAL
000	No color kill	Kill at <0.5%
001	Kill at <5%	Kill at <1.5%
010	Kill at <7%	Kill at <2.5%
011	Kill at <8%	Kill at <4.0%
100 (default)	Kill at <9.5%	Kill at <8.5%
101	Kill at <15%	Kill at <16.0%
110	Kill at <32%	Kill at <32.0%
111	Reserved for ADI internal use only. Do not select.	

**CHROMA TRANSIENT IMPROVEMENT (CTI)**

The signal bandwidth allocated for chroma is typically much smaller than that of luminance. In the past, this was a valid way to fit a color video signal into a given overall bandwidth because the human eye is less sensitive to chrominance than to luminance.

The uneven bandwidth, however, can lead to visual artifacts in sharp color transitions. At the border of two bars of color, both components (luma and chroma) change at the same time (see Figure 17). Due to the higher bandwidth, the signal transition of the luma component is usually much sharper than that of the chroma component. The color edge is not sharp but blurred, in the worst case, over several pixels.

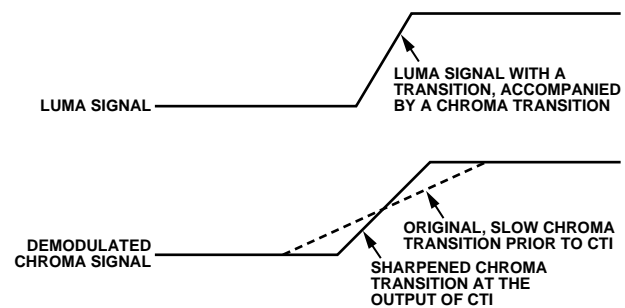

Figure 17. CTI Luma/Chroma Transition



The chroma transient improvement block examines the input video data. It detects transitions of chroma, and can be programmed to steepen the chroma edges in an attempt to artificially restore lost color bandwidth. The CTI block, however, operates only on edges above a certain threshold to ensure that noise is not emphasized. Care has been taken to ensure that edge ringing and undesirable saturation or hue distortion are avoided.

Chroma transient improvements are needed primarily for signals that experienced severe chroma bandwidth limitations. For those types of signals, it is strongly recommended to enable the CTI block via CTI\_EN.

#### **CTI\_EN Chroma Transient Improvement Enable, Address 0x4D[0]**

Setting CTI\_EN to 0 disables the CTI block.

Setting CTI\_EN to 1 (default) enables the CTI block.

#### **CTI\_AB\_EN Chroma Transient Improvement Alpha Blend Enable, Address 0x4D[1]**

The CTI\_AB\_EN bit enables an alpha-blend function within the CTI block. If set to 1, the alpha blender mixes the transient improved chroma with the original signal. The sharpness of the alpha blending can be configured via the CTI\_AB[1:0] bits.

For the alpha blender to be active, the CTI block must be enabled via the CTI\_EN bit.

Setting CTI\_AB\_EN to 0 disables the CTI alpha blender.

Setting CTI\_AB\_EN to 1 (default) enables the CTI alpha-blend mixing function.

#### **CTI\_AB[1:0] Chroma Transient Improvement Alpha Blend, Address 0x4D[3:2]**

The CTI\_AB[1:0] controls the behavior of alpha blend circuitry that mixes the sharpened chroma signal with the original one. It thereby controls the visual impact of CTI on the output data.

For CTI\_AB[1:0] to become active, the CTI block must be enabled via the CTI\_EN bit, and the alpha blender must be switched on via CTI\_AB\_EN.

Sharp blending maximizes the effect of CTI on the picture, but can also increase the visual impact of small amplitude, high frequency chroma noise.

**Table 42. CTI\_AB Function**

<b>CTI_AB[1:0]</b>	<b>Description</b>
00	Sharpest mixing between sharpened and original chroma signal
01	Sharp mixing
10	Smooth mixing
11 (default)	Smoothest alpha blend function

#### **CTI\_C\_TH[7:0] CTI Chroma Threshold, Address 0x4E[7:0]**

The CTI\_C\_TH[7:0] value is an unsigned, 8-bit number specifying how big the amplitude step in a chroma transition must be to be steepened by the CTI block. Programming a small value into this register causes even smaller edges to be steepened by the CTI block. Making CTI\_C\_TH[7:0] a large value causes the block to improve large transitions only.

The default value for CTI\_C\_TH[7:0] is 0x08, indicating the threshold for the chroma edges prior to CTI.

#### **DIGITAL NOISE REDUCTION (DNR)**

Digital noise reduction is based on the assumption that high frequency signals with low amplitude are probably noise and that their removal, therefore, improves picture quality.

#### **DNR\_EN Digital Noise Reduction Enable, Address 0x4D[5]**

The DNR\_EN bit enables the DNR block or bypasses it.

Setting DNR\_EN to 0 bypasses DNR (disables it).

Setting DNR\_EN to 1 (default) enables digital noise reduction on the luma data.

#### **DNR\_TH[7:0] DNR Noise Threshold, Address 0x50[7:0]**

The DNR\_TH[7:0] value is an unsigned 8-bit number used to determine the maximum edge that is interpreted as noise and therefore blanked from the luma data. Programming a large value into DNR\_TH[7:0] causes the DNR block to interpret even large transients as noise and remove them. The effect on the video data is, therefore, more visible.

Programming a small value causes only small transients to be seen as noise and to be removed.

The recommended DNR\_TH[7:0] setting for A/V inputs is 0x04, and the recommended DNR\_TH[7:0] setting for tuner inputs is 0x0A.

The default value for DNR\_TH[7:0] is 0x08, indicating the threshold for maximum luma edges to be interpreted as noise.

#### **COMB FILTERS**

The comb filters of the ADV7181B have been greatly improved to automatically handle video of all types, standards, and levels of quality. The NTSC and PAL configuration registers allow the user to customize comb filter operation, depending on which video standard is detected (by autodetection) or selected (by manual programming). In addition to the bits listed in this section, there are other ADI internal controls; contact ADI sales for more information.

#### **NTSC Comb Filter Settings**

Used for NTSC-M/J CVBS inputs.

# ADV7181B

## NSFSEL[1:0] Split Filter Selection NTSC, Address 0x19[3:2]

The NSFSEL[1:0] control selects how much of the overall signal bandwidth is fed to the combs. A narrow split filter selection gives better performance on diagonal lines, but leaves more dot crawl in the final output image. The opposite is true for selecting a wide bandwidth split filter.

**Table 43. NSFSEL Function**

NSFSEL[1:0]	Description
00 (default)	Narrow
01	Medium
10	Medium
11	Wide

## CTAPSN[1:0] Chroma Comb Taps NTSC, Address 0x38[7:6]

**Table 44. CTAPSN Function**

CTAPSN[1:0]	Description
00	Do not use
01	NTSC chroma comb adapts 3 lines (3 taps) to 2 lines (2 taps)
10 (default)	NTSC chroma comb adapts 5 lines (5 taps) to 3 lines (3 taps)
11	NTSC chroma comb adapts 5 lines (5 taps) to 4 lines (4 taps)

## CCMN[2:0] Chroma Comb Mode NTSC, Address 0x38[5:3]

**Table 45. CCMN Function**

CCMN[2:0]	Description	Configuration
0xx (default)	Adaptive comb mode	Adaptive 3-line chroma comb for CTAPSN = 01 Adaptive 4-line chroma comb for CTAPSN = 10 Adaptive 5-line chroma comb for CTAPSN = 11
100	Disable chroma comb	
101	Fixed chroma comb (top lines of line memory)	Fixed 2-line chroma comb for CTAPSN = 01 Fixed 3-line chroma comb for CTAPSN = 10 Fixed 4-line chroma comb for CTAPSN = 11
110	Fixed chroma comb (all lines of line memory)	Fixed 3-line chroma comb for CTAPSN = 01 Fixed 4-line chroma comb for CTAPSN = 10 Fixed 5-line chroma comb for CTAPSN = 11
111	Fixed chroma comb (bottom lines of line memory)	Fixed 2-line chroma comb for CTAPSN = 01 Fixed 3-line chroma comb for CTAPSN = 10 Fixed 4-line chroma comb for CTAPSN = 11

## YCMN[2:0] Luma Comb Mode NTSC, Address 0x38[2:0]

**Table 46. YCMN Function**

YCMN[2:0]	Description	Configuration
0xx (default)	Adaptive comb mode	Adaptive 3-line (3 taps) luma comb
100	Disable luma comb	Use low-pass/notch filter; see the Y-Shaping Filter section
101	Fixed luma comb (top lines of line memory)	Fixed 2-line (2 taps) luma comb
110	Fixed luma comb (all lines of line memory)	Fixed 3-line (3 taps) luma comb
111	Fixed luma comb (bottom lines of line memory)	Fixed 2-line (2 taps) luma comb

## PAL Comb Filter Settings

Used for PAL-B/G/H/I/D, PAL-M, PAL-combinational N, PAL-60, and NTSC443 CVBS inputs.

## PSFSEL[1:0] Split Filter Selection PAL, Address 0x19[1:0]

The PSFSEL[1:0] control selects how much of the overall signal bandwidth is fed to the combs. A wide split filter selection eliminates dot crawl, but shows imperfections on diagonal lines. The opposite is true for selecting a narrow bandwidth split filter.

**Table 47. PSFSEL Function**

PSFSEL[1:0]	Description
00	Narrow
01 (default)	Medium
10	Wide
11	Widest

## CTAPSP[1:0] Chroma Comb Taps PAL, Address 0x39[7:6]

Table 48. CTAPSP Function

CTAPSP[1:0]	Description
00	Do not use
01	PAL chroma comb adapts 5 lines (3 taps) to 3 lines (2 taps); cancels cross luma only
10	PAL chroma comb adapts 5 lines (5 taps) to 3 lines (3 taps); cancels cross luma and hue error less well
11 (default)	PAL chroma comb adapts 5 lines (5 taps) to 4 lines (4 taps); cancels cross luma and hue error well

## CCMP[2:0] Chroma Comb Mode PAL, Address 0x39[5:3]

Table 49. CCMP Function

CCMP[2:0]	Description	Configuration
0xx (default)	Adaptive comb mode	Adaptive 3-line chroma comb for CTAPSP = 01 Adaptive 4-line chroma comb for CTAPSP = 10 Adaptive 5-line chroma comb for CTAPSP = 11
100	Disable chroma comb	
101	Fixed chroma comb (top lines of line memory)	Fixed 2-line chroma comb for CTAPSP = 01 Fixed 3-line chroma comb for CTAPSP = 10 Fixed 4-line chroma comb for CTAPSP = 11
110	Fixed chroma comb (all lines of line memory)	Fixed 3-line chroma comb for CTAPSP = 01 Fixed 4-line chroma comb for CTAPSP = 10 Fixed 5-line chroma comb for CTAPSP = 11
111	Fixed chroma comb (bottom lines of line memory)	Fixed 2-line chroma comb for CTAPSP = 01 Fixed 3-line chroma comb for CTAPSP = 10 Fixed 4-line chroma comb for CTAPSP = 11

## YCMP[2:0] Luma Comb Mode PAL, Address 0x39[2:0]

Table 50. YCMP Function

YCMP[2:0]	Description	Configuration
0xx (default)	Adaptive comb mode.	Adaptive 5 lines (3 taps) luma comb
100	Disable luma comb	Use low-pass/notch filter; see the Y-Shaping Filter section
101	Fixed luma comb (top lines of line memory)	Fixed 3 lines (2 taps) luma comb
110	Fixed luma comb (all lines of line memory)	Fixed 5 lines (3 taps) luma comb
111	Fixed luma comb (bottom lines of line memory)	Fixed 3 lines (2 taps) luma comb

## AV CODE INSERTION AND CONTROLS

This section describes the I<sup>2</sup>C-based controls that affect:

- Insertion of AV codes into the data stream.
- Data blanking during the vertical blank interval (VBI).
- The range of data values permitted in the output data stream.
- The relative delay of luma vs. chroma signals.

Some of the decoded VBI data is being inserted during the horizontal blanking interval. See the Gemstar Data Recovery section for more information.

### BT656-4 ITU Standard BT-R.656-4 Enable, Address 0x04[7]

The ITU has changed the position for toggling of the V bit within the SAV EAV codes for NTSC between Revision 3 and Revision 4. The BT656-4 standard bit allows the user to select an output mode that is compliant with either the previous or the new standard. For more information, review the standard at [www.itu.int](http://www.itu.int).

The standard change affects NTSC only and has no bearing on PAL.

When BT656-4 is 0 (default), the BT656-3 specification is used. The V bit goes low at EAV of Line 10 and Line 273.

When BT656-4 is 1, the BT656-4 specification is used. The V bit goes low at EAV of Line 20 and Line 283.

### SD\_DUP\_AV Duplicate AV Codes, Address 0x03[0]

Depending on the output interface width, it can be necessary to duplicate the AV codes from the luma path into the chroma path.

In an 8-bit-wide output interface (Cb/Y/Cr/Y interleaved data), the AV codes are defined as FF/00/00/AV, with AV being the transmitted word that contains information about H/V/F.

In this output interface mode, the following assignment takes place: Cb = FF, Y = 00, Cr = 00, and Y = AV.

In a 16-bit output interface where Y and Cr/Cb are delivered via separate data buses, the AV code is over the whole 16 bits. The SD\_DUP\_AV bit allows the user to replicate the AV codes on both busses, so the full AV sequence can be found on the Y bus and on the Cr/Cb bus. See Figure 18.

When SD\_DUP\_AV is 0 (default), the AV codes are in single fashion (to suit 8-bit interleaved data output).

When SD\_DUP\_AV is 1, the AV codes are duplicated (for 16-bit interfaces).

### VBI\_EN Vertical Blanking Interval Data Enable, Address 0x03[7]

The VBI enable bit allows data such as intercast and closed caption data to be passed through the luma channel of the decoder with a minimal amount of filtering. All data for Line 1 to Line 21 is passed through and available at the output port. The ADV7181B does not blank the luma data, and automatically switches all filters along the luma data path into their widest bandwidth. For active video, the filter settings for YSH and YPK are restored.

Refer to the BL\_C\_VBI Blank Chroma during VBI section for information on the chroma path.

When VBI\_EN is 0 (default), all video lines are filtered/scaled.

When VBI\_EN is 1, only the active video region is filtered/scaled.

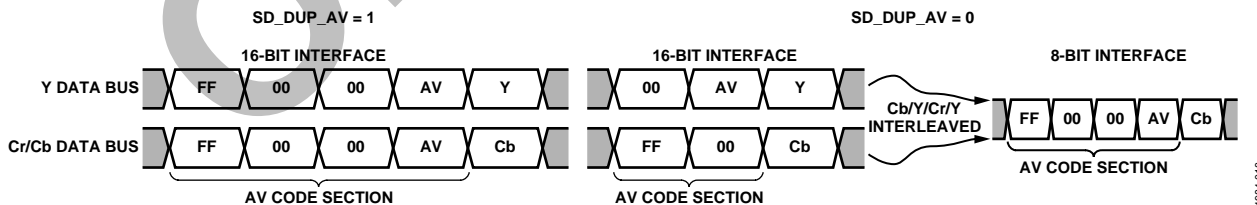

Figure 18. AV Code Duplication Control

**BL\_C\_VBI Blank Chroma During VBI, Address 0x04[2]**

Setting BL\_C\_VBI high, the Cr and Cb values of all VBI lines are blanked. This is done so any data that may arrive during VBI is not decoded as color and output through Cr and Cb. As a result, it is possible to send VBI lines into the decoder, then output them through an encoder again, undistorted. Without this blanking, any wrongly decoded color is encoded by the video encoder; therefore, the VBI lines are distorted.

Setting BL\_C\_VBI to 0 decodes and outputs color during VBI.

Setting BL\_C\_VBI to 1 (default) blanks Cr and Cb values during VBI.

**RANGE Range Selection, Address 0x04[0]**

AV codes (as per ITU-R BT-656, formerly known as CCIR-656) consist of a fixed header made up of 0xFF and 0x00 values. These two values are reserved and therefore are not to be used for active video. Additionally, the ITU specifies that the nominal range for video should be restricted to values between 16 and 235 for luma and 16 to 240 for chroma.

The RANGE bit allows the user to limit the range of values output by the ADV7181B to the recommended value range. In any case, it ensures that the reserved values of 255d (0xFF) and 00d (0x00) are not presented on the output pins unless they are part of an AV code header.

**Table 51. RANGE Function**

RANGE	Description	
0	$16 \leq Y \leq 235$	$16 \leq C/P \leq 240$
1 (default)	$1 \leq Y \leq 254$	$1 \leq C/P \leq 254$

**AUTO\_PDC\_EN Automatic Programmed Delay Control, Address 0x27[6]**

Enabling the AUTO\_PDC\_EN function activates a function within the ADV7181B that automatically programs the LTA[1:0] and CTA[2:0] to have the chroma and luma data match delays for all modes of operation. If set, manual registers LTA[1:0] and CTA[2:0] are not used. If the automatic mode is disabled (via setting the AUTO\_PDC\_EN bit to 0), the values programmed into LTA[1:0] and CTA[2:0] registers become active.

When AUTO\_PDC\_EN is 0, the ADV7181B uses the LTA[1:0] and CTA[2:0] values for delaying luma and chroma samples. Refer to the LTA[1:0] Luma Timing Adjust, Address 0x27[1:0] and the CTA[2:0] Chroma Timing Adjust, Address 0x27[5:3] sections.

When AUTO\_PDC\_EN is 1 (default), the ADV7181B automatically determines the LTA and CTA values to have luma and chroma aligned at the output.

**LTA[1:0] Luma Timing Adjust, Address 0x27[1:0]**

The luma timing adjust register allows the user to specify a timing difference between chroma and luma samples.

There is a certain functionality overlap with the CTA[2:0] register. For manual programming, use the following defaults:

- CVBS input LTA[1:0] = 00
- YC input LTA[1:0] = 01
- YPrPb input LTA[1:0] = 01

**Table 52. LTA Function**

LTA[1:0]	Description
00 (default)	No delay
01	Luma 1 clk (37 ns) delayed
10	Luma 2 clk (74 ns) early
11	Luma 1 clk (37 ns) early

**CTA[2:0] Chroma Timing Adjust, Address 0x27[5:3]**

The chroma timing adjust register allows the user to specify a timing difference between chroma and luma samples. This can be used to compensate for external filter group delay differences in the luma vs. chroma path, and to allow a different number of pipeline delays while processing the video downstream. Review this functionality together with the LTA[1:0] register.

The chroma can be delayed/advanced only in chroma pixel steps. One chroma pixel step is equal to two luma pixels. The programmable delay occurs after demodulation, where one can no longer delay by luma pixel steps.

For manual programming, use the following defaults:

- CVBS input CTA[2:0] = 011
- YC input CTA[2:0] = 101
- YPrPb input CTA[2:0] = 110

**Table 53. CTA Function**

CTA[2:0]	Description
000	Not used
001	Chroma + 2 chroma pixel (early)
010	Chroma + 1 chroma pixel (early)
011 (default)	No delay
100	Chroma – 1 chroma pixel (late)
101	Chroma – 2 chroma pixel (late)
110	Chroma – 3 chroma pixel (late)
111	Not used

## SYNCHRONIZATION OUTPUT SIGNALS

### HS Configuration

The following controls allow the user to configure the behavior of the HS output pin only:

- Beginning of HS signal via HSB[10:0]
- End of HS signal via HSE[10:0]
- Polarity of HS using PHS

The HS begin and HS end registers allow the user to freely position the HS output (pin) within the video line. The values in HSB[10:0] and HSE[10:0] are measured in pixel units from the falling edge of HS. Using both values, the user can program both the position and length of the HS output signal.

### HSB[10:0] HS Begin, Address 0x34[6:4], Address 0x35[7:0]

The position of this edge is controlled by placing a binary number into HSB[10:0]. The number applied offsets the edge with respect to an internal counter that is reset to 0 immediately after EAV Code FF, 00, 00, XY (see Figure 19). HSB is set to 00000000010b, which is 2 LLC1 clock cycles from Count[0].

The default value of HSB[10:0] is 0x002, indicating that the HS pulse starts two pixels after the falling edge of HS.

### HSE[10:0] HS End, Address 0x34[2:0], Address 0x36[7:0]

The position of this edge is controlled by placing a binary number into HSE[10:0]. The number applied offsets the edge with respect to an internal counter that is reset to 0 immediately after EAV Code FF, 00, 00, XY (see Figure 19). HSE is set to 00000000000b, which is 0 LLC1 clock cycles from Count[0].

The default value of HSE[10:0] is 000, indicating that the HS pulse ends zero pixels after a falling edge of HS.

For example

1. To shift the HS toward active video by 20 LLC1s, add 20 LLC1s to both HSB and HSE, that is, HSB[10:0] = [00000010110], HSE[10:0] = [00000010100].
2. To shift the HS away from active video by 20 LLC1s, add 1696 LLC1s to both HSB and HSE (for NTSC), that is, HSB[10:0] = [11010100010], HSE[10:0] = [11010100000]. 1696 is derived from the NTSC total number of pixels = 1716.

To move 20 LLC1s away from active video is equal to subtracting 20 from 1716 and adding the result in binary to both HSB[10:0] and HSE[10:0].

### PHS Polarity HS, Address 0x37[7]

The polarity of the HS pin can be inverted using the PHS bit.

When PHS is 0 (default), HS is active high.

When PHS is 1, HS is active low.

Table 54. HS Timing Parameters (see Figure 19)

Standard	Characteristic				
	HS Begin Adjust (HSB[10:0]) (Default)	HS End Adjust (HSE[10:0]) (Default)	HS to Active Video (LLC1 Clock Cycles) (C in Figure 19) (Default)	Active Video Samples/Line (D in Figure 19)	Total LLC1 Clock Cycles (E in Figure 19)
NTSC	00000000010b	00000000000b	272	720Y + 720C = 1440	1716
NTSC Square Pixel	00000000010b	00000000000b	276	640Y + 640C = 1280	1560
PAL	00000000010b	00000000000b	284	720Y + 720C = 1440	1728

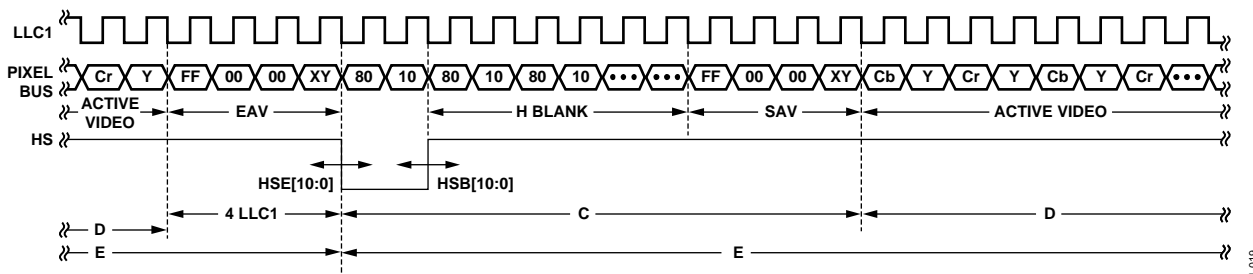

Figure 19. HS Timing

### VS and FIELD Configuration

The following controls allow the user to configure the behavior of the VS and FIELD output pins, as well as the generation of embedded AV codes:

- ADV encoder-compatible signals via NEWAVMODE
- PVS, PF
- HVSTIM
- VSBHO, VSBHE
- VSEHO, VSEHE
  - For NTSC control
    - NVBEGDELO, NVBEGDELE, NVBEGSIGN, NVBEG[4:0]
    - NVENDDELO, NVENDDELE, NVENDSIGN, NVEND[4:0]
    - NFTOGDELO, NFTOGDELE, NFTOGSIGN, NFTOG[4:0]
  - For PAL control
    - PVBEGDELO, PVBEGDELE, PVBEGSIGN, PVBEG[4:0]
    - PVENDDELO, PVENDDELE, PVENDSIGN, PVEND[4:0]
    - PFTOGDELO, PFTOGDELE, PFTOGSIGN, PFTOG[4:0]

#### NEWAVMODE New AV Mode, Address 0x31[4]

When NEWAVMODE is 0, EAV/SAV codes are generated to suit ADI encoders. No adjustments are possible.

Setting NEWAVMODE to 1 (default) enables the manual position of the VSYNC, Field, and AV codes using Register 0x34 to Register 0x37 and Register 0xE5 to Register 0xEA. Default register settings are CCIR656 compliant; see Figure 20 for NTSC and Figure 25 for PAL. For recommended manual user settings, see Table 55 for NTSC and see Table 56 and Figure 26 for PAL.

#### HVSTIM Horizontal VS Timing, Address 0x31[3]

The HVSTIM bit allows the user to select where the VS signal is asserted within a line of video. Some interface circuitry can require VS to go low while HS is low.

When HVSTIM is 0 (default), the start of the line is relative to HSE.

When HVSTIM is 1, the start of the line is relative to HSB.

#### VSBHO VS Begin Horizontal Position Odd, Address 0x32[7]

The VSBHO and VSBHE bits select the position within a line at which the VS pin (not the bit in the AV code) becomes active. Some follow-on chips require the VS pin to only change state when HS is high/low.

When VSBHO is 0 (default), the VS pin goes high at the middle of a line of video (odd field).

When VSBHO is 1, the VS pin changes state at the start of a line (odd field).

#### VSBHE VS Begin Horizontal Position Even, Address 0x32[6]

The VSBHO and VSBHE bits select the position within a line at which the VS pin (not the bit in the AV code) becomes active. Some follow-on chips require the VS pin to only change state when HS is high/low.

When VSBHE is 0 (default), the VS pin goes high at the middle of a line of video (even field).

When VSBHE is 1, the VS pin changes state at the start of a line (even field).

#### VSEHO VS End Horizontal Position Odd, Address 0x33[7]

The VSEHO and VSEHE bits select the position within a line at which the VS pin (not the bit in the AV code) becomes active. Some follow-on chips require the VS pin to only change state when HS is high/low.

When VSEHO is 0 (default), the VS pin goes low (inactive) at the middle of a line of video (odd field).

When VSEHO is 1, the VS pin changes state at the start of a line (odd field).

#### VSEHE VS End Horizontal Position Even, Address 0x33[6]

The VSEHO and VSEHE bits select the position within a line at which the VS pin (not the bit in the AV code) becomes active. Some follow-on chips require the VS pin to only change state when HS is high/low.

When VSEHE is 0, the VS pin goes low (inactive) at the middle of a line of video (even field).

When VSEHE is 1 (default), the VS pin changes state at the start of a line (even field).

#### PVS Polarity VS, Address 0x37[5]

The polarity of the VS pin can be inverted using the PVS bit. When PVS is 0 (default), VS is active high. When PVS is 1, VS is active low.

# ADV7181B

## PF Polarity FIELD, Address 0x37[3]

The polarity of the FIELD pin can be inverted using the PF bit.

The FIELD pin can be inverted using the PF bit.

When PF is 0 (default), FIELD is active high.

When PF is 1, FIELD is active low.

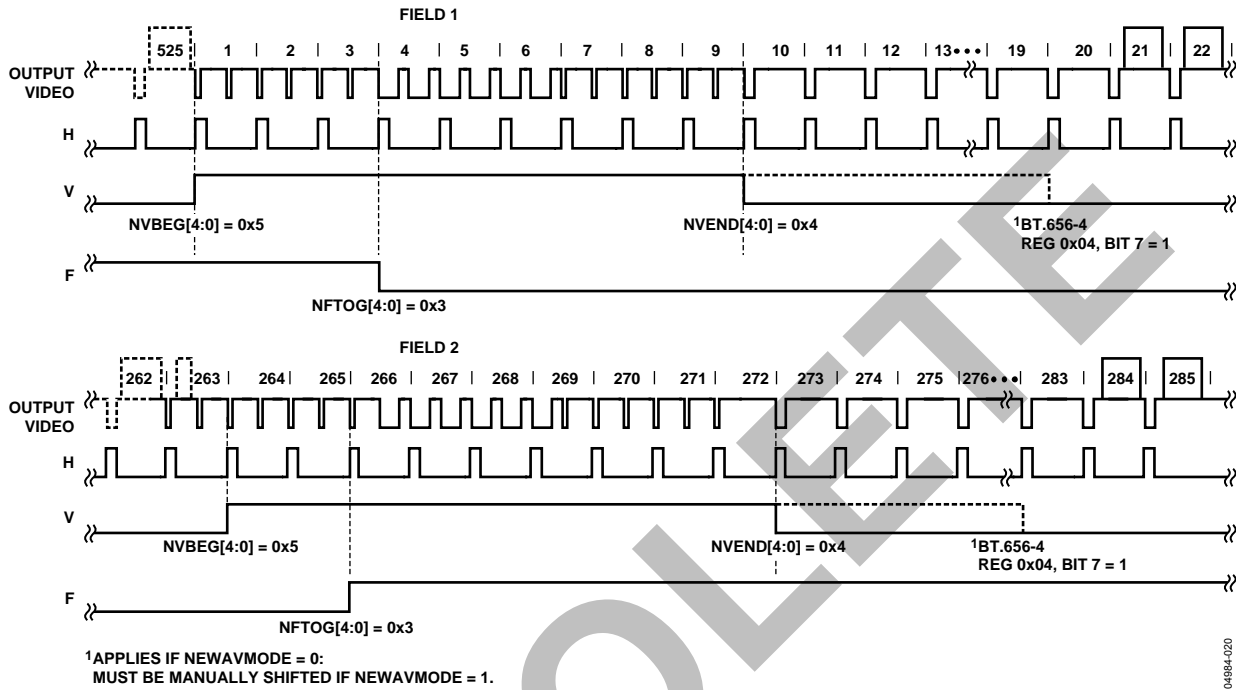

Figure 20. NTSC Default (BT.656). The Polarity of H, V, and F is Embedded in the Data.

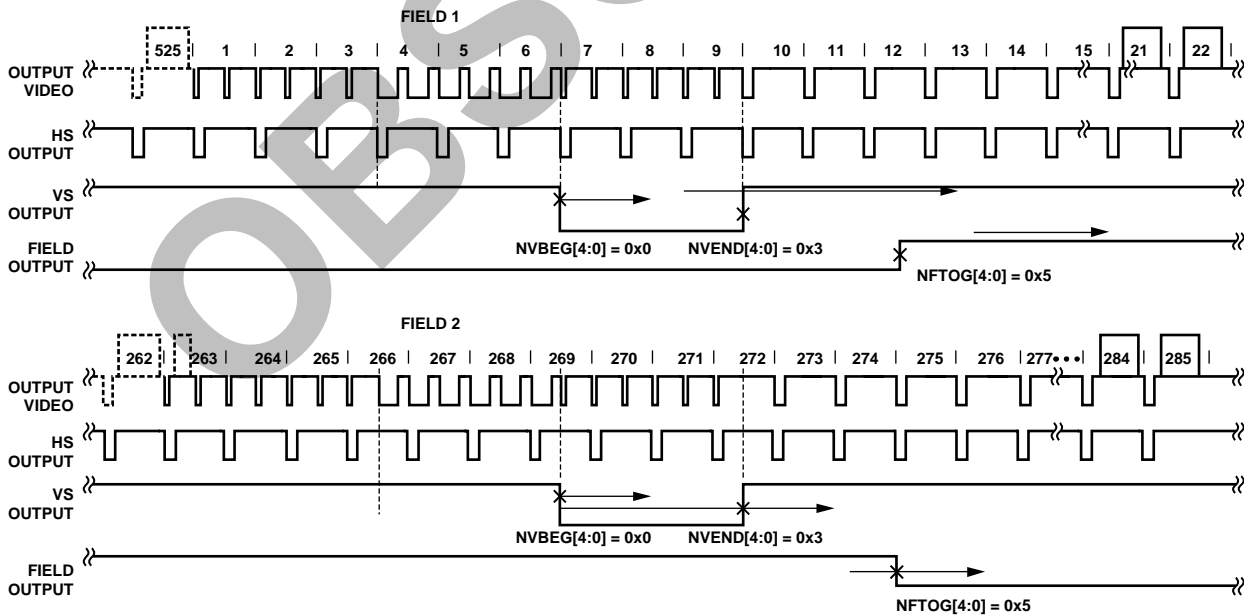

Figure 21. NTSC Typical Vsync/Field Positions Using Register Writes in Table 55



Table 55. Recommended User Settings for NTSC (See Figure 21)

Register	Register Name	Write
0x31	Vsync Field Control 1	0x1A
0x32	Vsync Field Control 2	0x81
0x33	Vsync Field Control 3	0x84
0x34	Hsync Pos. Control 1	0x00
0x35	Hsync Pos. Control 1	0x00
0x36	Hsync Pos. Control 1	0x7D
0x37	Polarity	0xA1
0xE5	NTSV_V_Bit_Beg	0x41
0xE6	NTSC_V_Bit_End	0x84
0xE7	NTSC_F_Bit_Tog	0x06

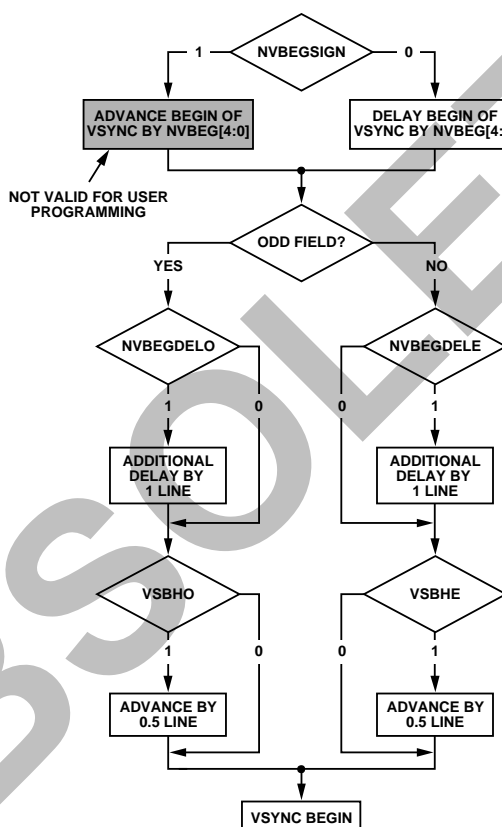

Figure 22. NTSC Vsync Begin

**NVBEGDELO NTSC Vsync Begin Delay on Odd Field, Address 0xE5[7]**

When NVBEGDELO is 0 (default), there is no delay.

Setting NVBEGDELO to 1 delays Vsync going high on an odd field by a line relative to NVBEG.

**NVBEGDELE NTSC Vsync Begin Delay on Even Field, Address 0xE5[6]**

When NVBEGDELE is 0 (default), there is no delay.

Setting NVBEGDELE to 1 delays Vsync going high on an even field by a line relative to NVBEG.

**NVBEGSIGN NTSC Vsync Begin Sign, Address 0xE5[5]**

Setting NVBEGSIGN to 0 delays the start of Vsync. Set for user manual programming.

Setting NVBEGSIGN to 1 (default) advances the start of Vsync. Not recommended for user programming.

**NVBEG[4:0] NTSC Vsync Begin, Address 0xE5[4:0]**

The default value of NVBEG is 00101, indicating the NTSC Vsync begin position.

For all NTSC/PAL Vsync timing controls, both the V bit in the AV code and the Vsync on the VS pin are modified.

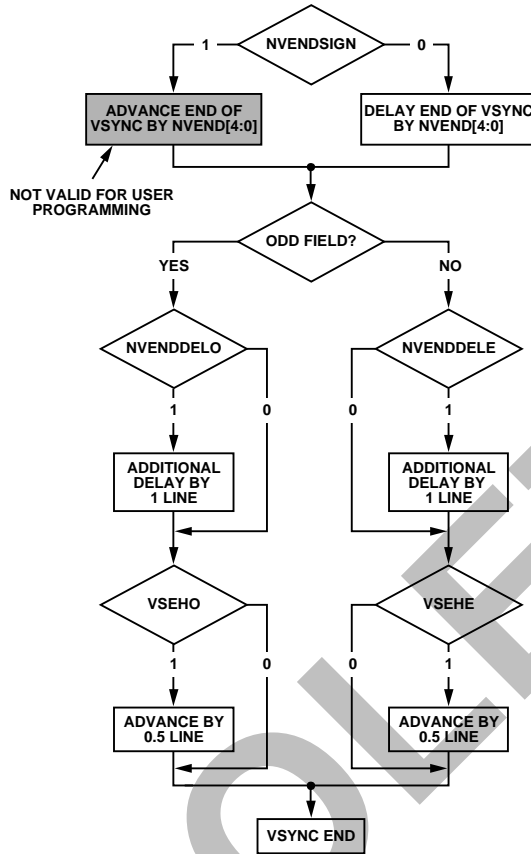

Figure 23. NTSC Vsync End

**NVENDDELO NTSC Vsync End Delay on Odd Field, Address 0xE6[7]**

When NVENDDELO is 0 (default), there is no delay.

Setting NVENDDELO to 1 delays Vsync from going low on an odd field by a line relative to NVEND.

**NVENDDELE NTSC Vsync End Delay on Even Field, Address 0xE6[6]**

When NVENDDELE is set to 0 (default), there is no delay.

Setting NVENDDELE to 1 delays Vsync from going low on an even field by a line relative to NVEND.

**NVENDSIGN NTSC Vsync End Sign, Address 0xE6[5]**

Setting NVENDSIGN to 0 (default) delays the end of Vsync. Set for user manual programming.

Setting NVENDSIGN to 1 advances the end of Vsync. Not recommended for user programming.

**NVEND NTSC[4:0] Vsync End, Address 0xE6[4:0]**

The default value of NVEND is 00100, indicating the NTSC Vsync end position.

For all NTSC/PAL Vsync timing controls, both the V bit in the AV code and the Vsync on the VS pin are modified.

**NFTOGDELO NTSC Field Toggle Delay on Odd Field, Address 0xE7[7]**

When NFTOGDELO is 0 (default), there is no delay.

Setting NFTOGDELO to 1 delays the field toggle/transition on an odd field by a line relative to NFTOG.

**NFTOGDELE NTSC Field Toggle Delay on Even Field, Address 0xE7[6]**

When NFTOGDELE is 0, there is no delay.

Setting NFTOGDELE to 1 (default) delays the field toggle/transition on an even field by a line relative to NFTOG.

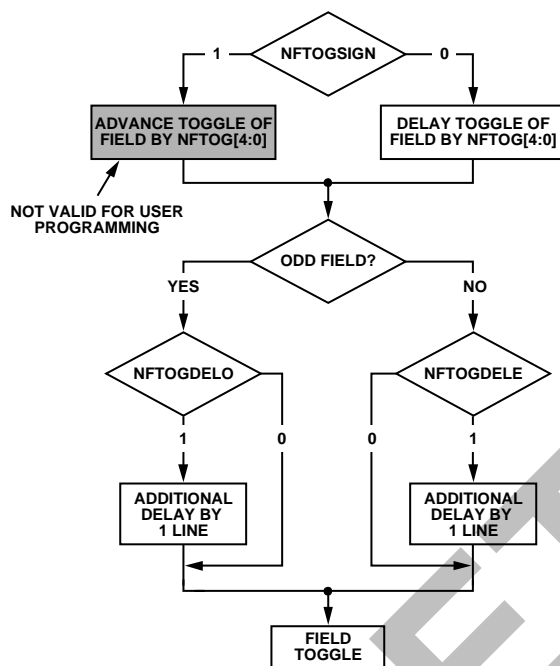

Figure 24. NTSC Field Toggle

Table 56. Recommended User Settings for PAL (see Figure 26)

Register	Register Name	Write
0x31	Vsync Field Control 1	0x1A
0x32	Vsync Field Control 2	0x81
0x33	Vsync Field Control 3	0x84
0x34	Hsync Pos. Control 1	0x00
0x35	Hsync Pos. Control 2	0x00
0x36	Hsync Pos. Control 3	0x7D
0x37	Polarity	0xA1
0xE8	PAL_V_Bit_Beg	0x41
0xE9	PAL_V_Bit_End	0x84
0xEA	PAL_F_Bit_Tog	0x06

**NFTOGSIGN NTSC Field Toggle Sign, Address 0xE7[5]**

Setting NFTOGSIGN to 0 delays the field transition. Set for user manual programming.

Setting NFTOGSIGN to 1 (default) advances the field transition. Not recommended for user programming.

**NFTOG[4:0] NTSC Field Toggle, Address 0xE7[4:0]**

The default value of NFTOG is 00011, indicating the NTSC field toggle position.

For all NTSC/PAL field timing controls, both the F bit in the AV code and the Field signal on the FIELD pin are modified.

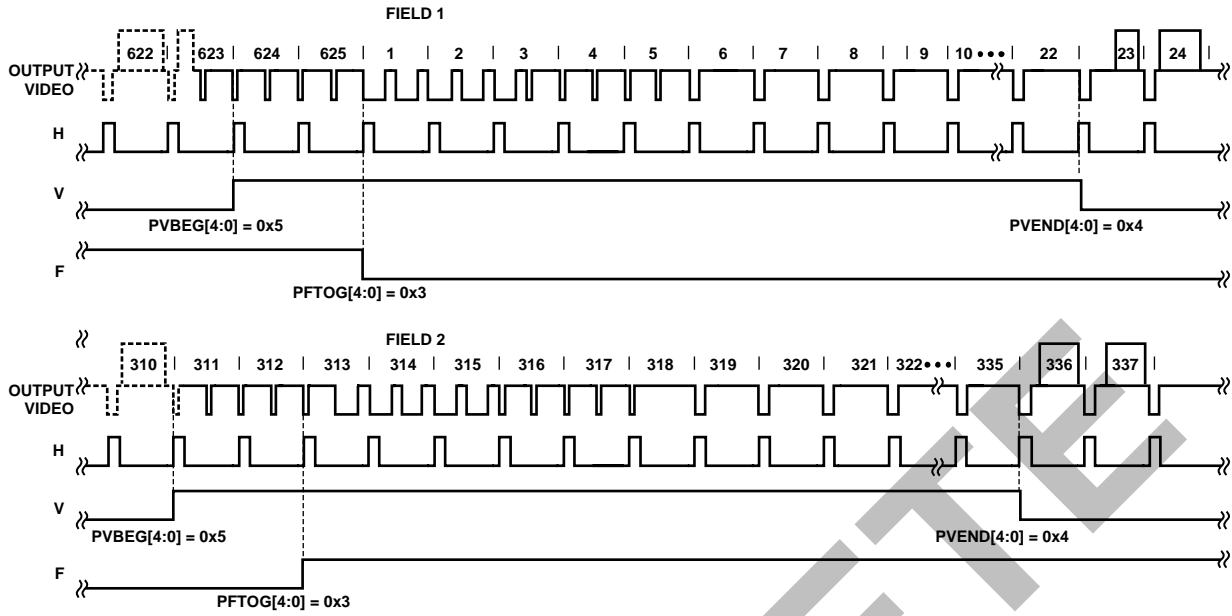

Figure 25. PAL Default (BT.656). The Polarity of H, V, and F is Embedded in the Data

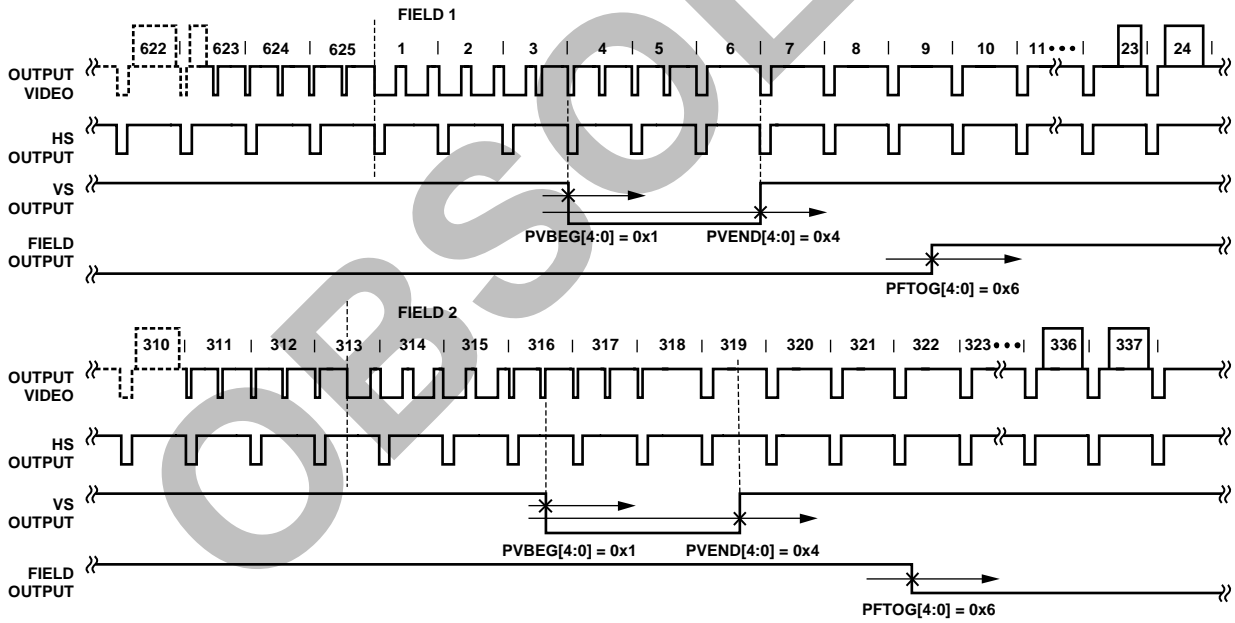

Figure 26. PAL Typical Vsync/Field Positions Using Register Writes in Table 56

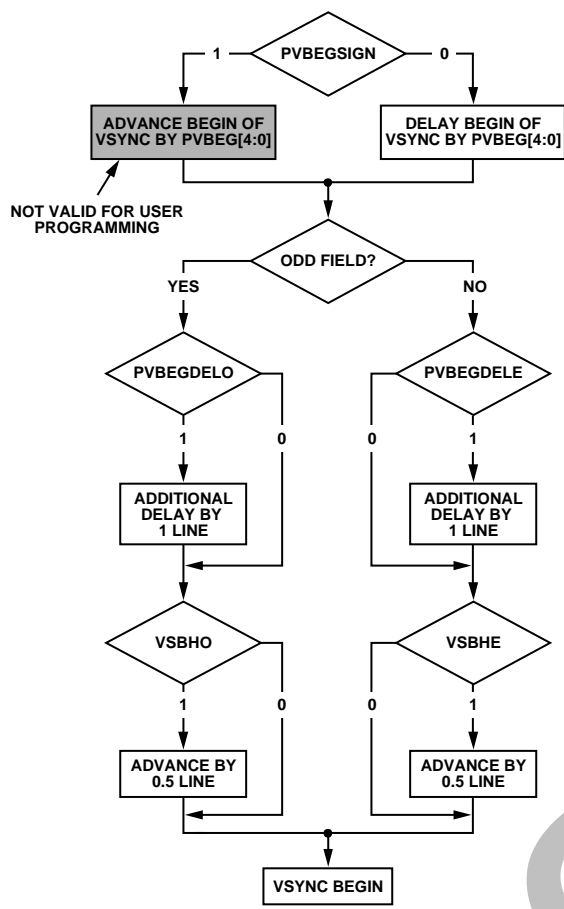

Figure 27. PAL Vsync Begin

**PVBEGDELO PAL Vsync Begin Delay on Odd Field, Address 0xE8[7]**

When PVBEGDELO is 0 (default), there is no delay.

Setting PVBEGDELO to 1 delays Vsync going high on an odd field by a line relative to PVBE.

**PVBEGDELE PAL Vsync Begin Delay on Even Field, Address 0xE8[6]**

When PVBEGDELE is 0, there is no delay.

Setting PVBEGDELE to 1 (default) delays Vsync going high on an even field by a line relative to PVBE.

**PVBEGSIGN PAL Vsync Begin Sign, Address 0xE8[5]**

Setting PVBEGSIGN to 0 delays the beginning of Vsync. Set for user manual programming.

Setting PVBEGSIGN to 1(default) advances the beginning of Vsync. Not recommended for user programming.

**PVBE[4:0] PAL Vsync Begin, Address 0xE8[4:0]**

The default value of PVBE is 00101, indicating the PAL Vsync begin position.

For all NTSC/PAL Vsync timing controls, both the V bit in the AV code and the Vsync on the VS pin are modified.

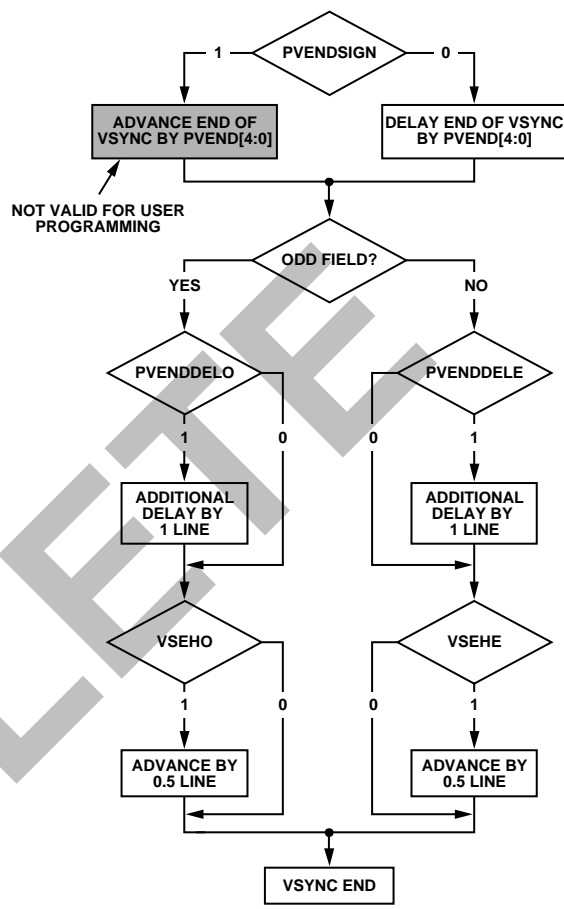

Figure 28. PAL Vsync End

**PVENDDELO PAL Vsync End Delay on Odd Field, Address 0xE9[7]**

When PVENDDELO is 0 (default), there is no delay.

Setting PVENDDELO to 1 delays Vsync going low on an odd field by a line relative to PVEND.

**PVENDDELE PAL Vsync End Delay on Even Field, Address 0xE9[6]**

When PVENDDELE is 0 (default), there is no delay.

Setting PVENDDELE to 1 delays Vsync going low on an even field by a line relative to PVEND.

**PVENDSIGN PAL Vsync End Sign, Address 0xE9[5]**

Setting PVENDSIGN to 0 (default) delays the end of Vsync. Set for user manual programming.

Setting PVENDSIGN to 1 advances the end of Vsync. Not recommended for user programming.

# ADV7181B

## PVEND[4:0] PAL Vsync End, Address 0xE9[4:0]

The default value of PVEND is 10100, indicating the PAL Vsync end position.

For all NTSC/PAL Vsync timing controls, both the V bit in the AV code and the Vsync on the VS pin are modified.

## PFTOGDELO PAL Field Toggle Delay on Odd Field, Address 0xEA[7]

When PFTOGDELO is 0 (default), there is no delay.

Setting PFTOGDELO to 1 delays the F toggle/transition on an odd field by a line relative to PFTOG.

## PFTOGDELE PAL Field Toggle Delay on Even Field, Address 0xEA[6]

When PFTOGDELE is 0, there is no delay.

Setting PFTOGDELE to 1 (default) delays the F toggle/transition on an even field by a line relative to PFTOG.

## PFTOGSIGN PAL Field Toggle Sign, Address 0xEA[5]

Setting PFTOGSIGN to 0 delays the field transition. Set for user manual programming.

Setting PFTOGSIGN to 1 (default) advances the field transition. Not recommended for user programming.

## PFTOG PAL Field Toggle, Address 0xEA[4:0]

The default value of PFTOG is 00011, indicating the PAL field toggle position.

For all NTSC/PAL Field timing controls, the F bit in the AV code and the field signal on the FIELD/DE pin are modified.

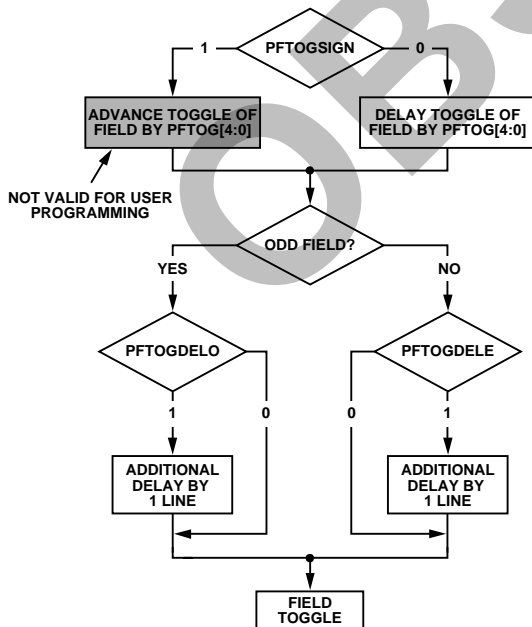

Figure 29. PAL F Toggle

## SYNC PROCESSING

The ADV7181B has two additional sync processing blocks that postprocess the raw synchronization information extracted from the digitized input video. If preferred, the blocks can be disabled via the following two I<sup>2</sup>C bits.

### ENHSPLL Enable Hsync Processor, Address 0x01[6]

The Hsync processor is designed to filter incoming Hsyncs that have been corrupted by noise, providing improved performance for video signals with stable time bases but poor SNR.

Setting ENHSPLL to 0 disables the Hsync processor.

Setting ENHSPLL to 1 (default) enables the Hsync processor.

### ENVSPROC Enable Vsync Processor, Address 0x01[3]

This block provides extra filtering of the detected Vsyncs to give improved vertical lock.

Setting ENVSPROC to 0 disables the Vsync processor.

Setting ENVSPROC to 1 (default) enables the Vsync processor.

## VBI DATA DECODE

The following low data rate VBI signals can be decoded by the ADV7181B:

- Wide screen signaling (WSS)
- Copy generation management systems (CGMS)
- Closed captioning (CC)
- EDTV
- Gemstar 1×- and 2×-compatible data recovery

The presence of any of the above signals is detected and, if applicable, a parity check is performed. The result of this testing is contained in a confidence bit in the VBI Info[7:0] register. Users are encouraged to first examine the VBI Info register before reading the corresponding data registers. All VBI data decode bits are read only.

All VBI data registers are double-buffered with the field signals. This means that data is extracted from the video lines and appears in the appropriate I<sup>2</sup>C registers with the next field transition. They are then static until the next field.

The user should start an read sequence with VS by first examining the VBI Info register. Then, depending on what data was detected, the appropriate data registers should be read.

The data registers are filled with decoded VBI data even if their corresponding detection bits are low; it is likely that bits within the decoded data stream are wrong.

The closed captioning data (CCAP) is available in the I<sup>2</sup>C registers, and is also inserted into the output video data stream during horizontal blanking.

The Gemstar-compatible data is not available in the I<sup>2</sup>C registers, and is inserted into the data stream only during horizontal blanking.

**WSSD Wide Screen Signaling Detected, Address 0x90[0]**

Logic 1 for this bit indicates the data in the WSS1 and WSS2 registers is valid.

The WSSD bit goes high if the rising edge of the start bit is detected within a time window, and if the polarity of the parity bit matches the transmitted data.

When WSSD is 0, no WSS is detected and confidence in the decoded data is low.

When WSSD is 1, WSS is detected and confidence in the decoded data is high.

**CCAPD Closed Caption Detected, Address 0x90[1]**

Logic 1 for this bit indicates the data in the CCAP1 and CCAP2 registers is valid.

The CCAPD bit goes high if the rising edge of the start bit is detected within a time window, and if the polarity of the parity bit matches the transmitted data.

When CCAPD is 0, no CCAP signals are detected and confidence in the decoded data is low.

When CCAPD is 1, the CCAP sequence is detected and confidence in the decoded data is high.

**EDTVD EDTV Sequence Detected, Address 0x90[2]**

Logic 1 for this bit indicates the data in the EDTV1, 2, 3 registers is valid.

The EDTVD bit goes high if the rising edge of the start bit is detected within a time window, and if the polarity of the parity bit matches the transmitted data.

When EDTVD is 0, no EDTV sequence is detected. Confidence in decoded data is low.

When EDTVD is 1, an EDTV sequence is detected. Confidence in decoded data is high.

**CGMSD CGMS-A Sequence Detected, Address 0x90[3]**

Logic 1 for this bit indicates the data in the CGMS1, 2, 3 registers is valid. The CGMSD bit goes high if a valid CRC checksum has been calculated from a received CGMS packet.

When CGMSD is 0, no CGMS transmission is detected and confidence in decoded data is low.

When CGMSD is 1, the CGMS sequence is decoded and confidence in decoded data is high.

**CRC\_ENABLE CRC CGMS-A Sequence, Address 0xB2[2]**

For certain video sources, the CRC data bits can have an invalid format. In such circumstances, the CRC checksum validation procedure can be disabled. The CGMSD bit goes high if the rising edge of the start bit is detected within a time window.

When CRC\_ENABLE is 0, no CRC check is performed. The CGMSD bit goes high if the rising edge of the start bit is detected within a time window.

When CRC\_ENABLE is 1 (default), CRC checksum is used to validate the CGMS sequence. The CGMSD bit goes high for a valid checksum. ADI recommended setting.

**Wide Screen Signaling Data**

WSS1[7:0], Address 0x91[7:0],

WSS2[7:0], Address 0x92[7:0]

Figure 30 shows the bit correspondence between the analog video waveform and the WSS1/WSS2 registers. WSS2[7:6] are undetermined and should be masked out by software.

**EDTV Data Registers**

EDTV1[7:0], Address 0x93[7:0],

EDTV2[7:0], Address 0x94[7:0],

EDTV3[7:0], Address 0x95[7:0]

Figure 31 shows the bit correspondence between the analog video waveform and the EDTV1/EDTV2/EDTV3 registers.

EDTV3[7:6] are undetermined and should be masked out by software. EDTV3[5] is reserved for future use and, for now, contains a 0. The three LSBs of the EDTV waveform are currently not supported.

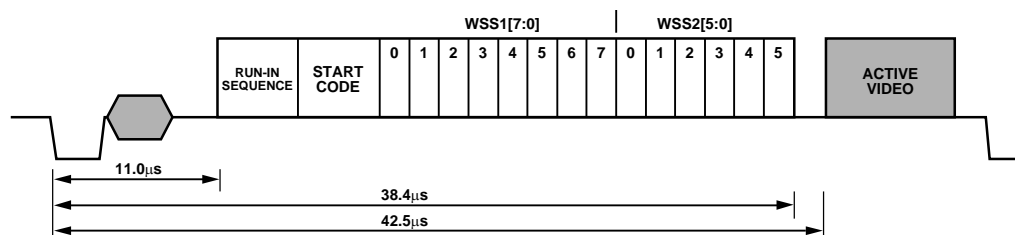

Figure 30. WSS Data Extraction

# ADV7181B

Table 57. WSS Access Information

Signal Name	Register Location	Address		Register Default Value
WSS1[7:0]	WSS 1[7:0]	145d	0x91	Readback only
WSS2[5:0]	WSS 2[5:0]	146d	0x92	Readback only

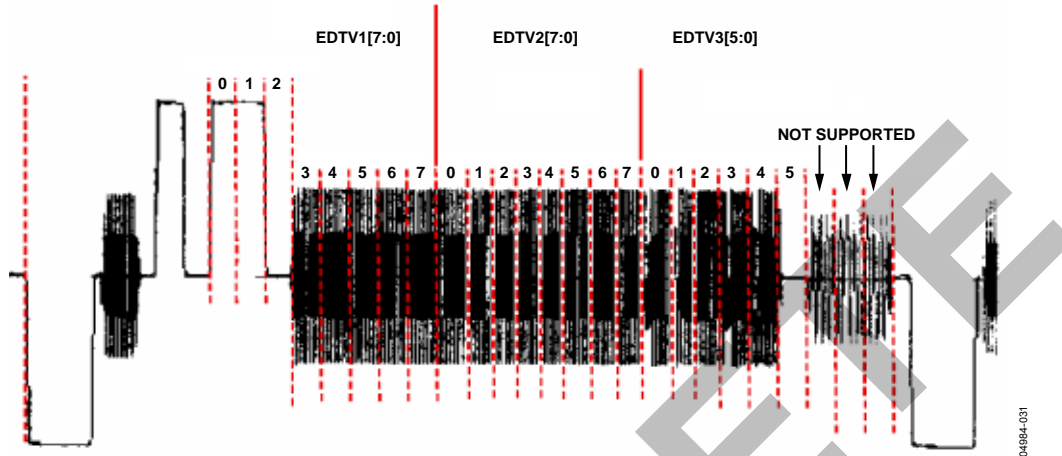

Figure 31. EDTV Data Extraction

Table 58. EDTV Access Information

Signal Name	Register Location	Address		Register Default Value
EDTV1[7:0]	EDTV 1[7:0]	147d	0x93	Readback only
EDTV2[7:0]	EDTV 2[7:0]	148d	0x94	Readback only
EDTV3[7:0]	EDTV 3[7:0]	149d	0x95	Readback only

## CGMS Data Registers

CGMS1[7:0], Address 0x96[7:0]

CGMS2[7:0], Address 0x97[7:0]

CGMS3[7:0], Address 0x98[7:0]

Figure 32 shows the bit correspondence between the analog video waveform and the CGMS1/CGMS2/CGMS3 registers. CGMS3[7:4] are undetermined and should be masked out by software.

## Closed Caption Data Registers

CCAP1[7:0], Address 0x99[7:0]

CCAP2[7:0], Address 0x9A[7:0]

Figure 33 shows the bit correspondence between the analog video waveform and the CCAP1/CCAP2 registers.

CCAP1[7] contains the parity bit from the first word.

CCAP2[7] contains the parity bit from the second word.

Refer to the GDECAD Gemstar Decode Ancillary Data Format, Address 0x4C[0] section.

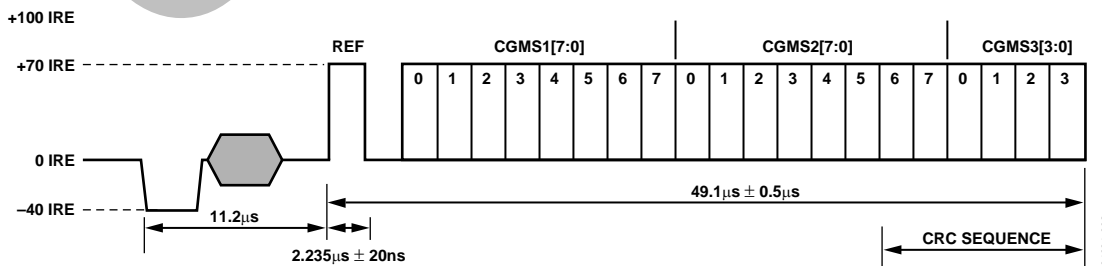

Figure 32. CGMS Data Extraction



**Table 59. CGMS Access Information**

Signal Name	Register Location	Address		Register Default Value
CGMS1[7:0]	CGMS 1[7:0]	150d	0x96	Readback Only
CGMS2[7:0]	CGMS 2[7:0]	151d	0x97	Readback Only
CGMS3[3:0]	CGMS 3[3:0]	152d	0x98	Readback Only

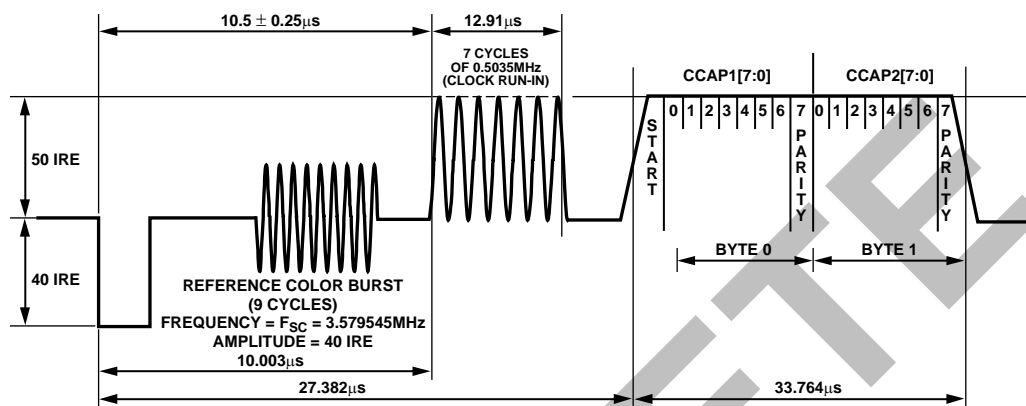

Figure 33. Closed Caption Data Extraction

**Table 60. CCAP Access Information**

Signal Name	Register Location	Address		Register Default Value
CCAP1[7:0]	CCAP 1[7:0]	153d	0x99	Readback only
CCAP2[7:0]	CCAP 2[7:0]	154d	0x9A	Readback only

### Letterbox Detection

Incoming video signals can conform to different aspect ratios (16:9 wide screen or 4:3 standard). For certain transmissions in the wide screen format, a digital sequence (WSS) is transmitted with the video signal. If a WSS sequence is provided, the aspect ratio of the video can be derived from the digitally decoded bits WSS contains.

In the absence of a WSS sequence, letterbox detection can be used to find wide screen signals. The detection algorithm examines the active video content of lines at the start and end of a field. If black lines are detected, it indicates the picture currently displayed is in wide screen format.

The active video content (luminance magnitude) over a line of video is summed together. At the end of a line, this accumulated value is compared with a threshold, and a decision is made as to whether or not a particular line is black. The threshold value needed can depend on the type of input signal; some control is provided via LB\_TH[4:0].

### Detection at the Start of a Field

The ADV7181B expects a section of at least six consecutive black lines of video at the top of a field. Once those lines are detected, Register LB\_LCT[7:0] reports back the number of black lines that were actually found. By default, the ADV7181B starts looking for those black lines in sync with the beginning of active video, for example, straight after the last VBI video line.

LB\_SL[3:0] allows the user to set the start of letterbox detection from the beginning of a frame on a line-by-line basis. The detection window closes in the middle of the field.

### Detection at the End of a Field

The ADV7181B expects at least six continuous lines of black video at the bottom of a field before reporting back the number of lines actually found via the LB\_LCB[7:0] value. The activity window for letterbox detection (end of field) starts in the middle of an active field. Its end is programmable via LB\_EL[3:0].

### Detection at the Midrange

Some transmissions of wide screen video include subtitles within the lower black box. If the ADV7181B finds at least two black lines followed by some more nonblack video, for example, the subtitle, and is then followed by the remainder of the bottom black block, it reports back a midcount via LB\_LCM[7:0]. If no subtitles are found, LB\_LCM[7:0] reports the same number as LB\_LCB[7:0].

There is a two-field delay in the reporting of any line count parameters.

There is no letterbox detected bit. The user is asked to read the LB\_LCT[7:0] and LB\_LCB[7:0] register values and to conclude whether or not the letterbox-type video is present in software.

# ADV7181B

**LB\_LCT[7:0] Letterbox Line Count Top, Address 0x9B[7:0]; LB\_LCM[7:0] Letterbox Line Count Mid, Address 0x9C[7:0]; LB\_LCB[7:0] Letterbox Line Count Bottom, Address 0x9D[7:0]**

**Table 61. LB\_LCx Access Information**

Signal Name	Address	Register Default Value
LB_LCT[7:0]	0x9B	Readback only
LB_LCM[7:0]	0x9C	Readback only
LB_LCB[7:0]	0x9D	Readback only

**LB\_TH[4:0] Letterbox Threshold Control, Address 0xDC[4:0]**

**Table 62. LB\_TH Function**

LB_TH[4:0]	Description
01100 (default)	Default threshold for detection of black lines
01101 to 10000	Increase threshold (need larger active video content before identifying non-black lines)
00000 to 01011	Decrease threshold (even small noise levels can cause the detection of non-black lines)

**LB\_SL[3:0] Letterbox Start Line, Address 0xDD[7:4]**

The LB\_SL[3:0] bits are set at 0100b by default. This means the letterbox detection window starts after the EDTV VBI data line. For an NTSC signal, this window is from Line 23 to Line 286.

Changing the bits to 0101, the detection window starts on Line 24 and ends on Line 287.

**LB\_EL[3:0] Letterbox End Line, Address 0xDD[3:0]**

The LB\_EL[3:0] bits are set at 1101b by default. This means that letterbox detection window ends with the last active video line. For an NTSC signal, this window is from Line 262 to Line 525.

Changing the bits to 1100, the detection window starts on Line 261 and ends on Line 254.

## Gemstar Data Recovery

The Gemstar-compatible data recovery block (GSCD) supports 1× and 2× data transmissions. In addition, it can also serve as a closed caption decoder. Gemstar-compatible data transmissions can only occur in NTSC. Closed caption data can be decoded in both PAL and NTSC.

The block is configured via I<sup>2</sup>C in the following ways:

- GDECEL[15:0] allows data recovery on selected video lines on even fields to be enabled and disabled.
- GDECOL[15:0] enables the data recovery on selected lines for odd fields.
- GDECAD configures the way in which data is embedded in the video data stream.

The recovered data is not available through I<sup>2</sup>C, but is inserted into the horizontal blanking period of an ITU-R BT.656-compatible data stream. The data format is intended to comply with the recommendation by the International Telecommunications Union, ITU-R BT.1364. See Figure 34. For more information, see the ITU website at [www.itu.ch](http://www.itu.ch).

The format of the data packet depends on the following criteria:

- Transmission is 1× or 2×.
- Data is output in 8-bit or 4-bit format (see the GDECAD Gemstar Decode Ancillary Data Format, Address 0x4C[0] section).
- Data is closed caption (CCAP) or Gemstar-compatible.

Data packets are output if the corresponding enable bit is set (see the GDECEL[15:0] Gemstar Decoding Even Lines, Address 0x48[7:0]; Address 0x49[7:0] and GDECOL[15:0] Gemstar Decoding Odd Lines, Address 0x4A[7:0]; Address 0x4B[7:0] sections), and if the decoder detects the presence of data. This means that for video lines where no data has been decoded, no data packet is output even if the corresponding line enable bit is set.

Each data packet starts immediately after the EAV code of the preceding line. Figure 34 and Table 63 show the overall structure of the data packet.

Entries within the packet are as follows:

- Fixed preamble sequence of 0x00, 0xFF, 0xFF.
- Data identification word (DID). The value for the DID marking a Gemstar or CCAP data packet is 0x140 (10-bit value).
- Secondary data identification word (SDID) contains information about the video line from which data was retrieved, whether the Gemstar transmission was of 1× or 2× format, and whether it was retrieved from an even or odd field.
- Data count byte, giving the number of user data-words that follow.
- User data section.
- Optional padding to ensure the length of the user data-word section of a packet is a multiple of four bytes, requirement as set in ITU-R BT.1364.
- Checksum byte.

Table 63 lists the values within a generic data packet that are output by the ADV7181B in 8-bit format. In 8-bit systems, Bits D1 and D0 in the data packets are disregarded.

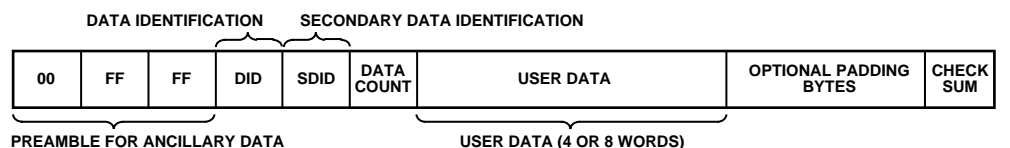

Figure 34. Gemstar and CCAP Embedded Data Packet (Generic)

04984-034

Table 63. Generic Data Output Packet

Byte	D[9]	D[8]	D[7]	D[6]	D[5]	D[4]	D[3]	D[2]	D[1]	D[0]	Description
0	0	0	0	0	0	0	0	0	0	0	Fixed preamble
1	1	1	1	1	1	1	1	1	1	1	Fixed preamble
2	1	1	1	1	1	1	1	1	1	1	Fixed preamble
3	0	1	0	1	0	0	0	0	0	0	DID
4	!EP	EP	EF	2X	Line[3:0]				0	0	SDID
5	!EP	EP	0	0	0	0	DC[1]	DC[0]	0	0	Data count (DC)
6	!EP	EP	0	0	Word1[7:4]				0	0	User data-words
7	!EP	EP	0	0	Word1[3:0]				0	0	User data-words
8	!EP	EP	0	0	Word2[7:4]				0	0	User data-words
9	!EP	EP	0	0	Word2[3:0]				0	0	User data-words
10	!EP	EP	0	0	Word3[7:4]				0	0	User data-words
11	!EP	EP	0	0	Word3[3:0]				0	0	User data-words
12	!EP	EP	0	0	Word4[7:4]				0	0	User data-words
13	!EP	EP	0	0	Word4[3:0]				0	0	User data-words
14	!CS[8]	CS[8]	CS[7]	CS[6]	CS[5]	CS[4]	CS[3]	CS[2]	0	0	Checksum

Table 64. Data Byte Allocation

2x	Raw Information Bytes Retrieved from the Video Line	GDECAD	User Data-Words (Including Padding)	Padding Bytes	DC[1:0]
1	4	0	8	0	10
1	4	1	4	0	01
0	2	0	4	0	01
0	2	1	4	2	01

**Gemstar Bit Names**

- DID. The data identification value is 0x140 (10-bit value). Care has been taken so the two LSBs do not carry vital information in 8-bit systems.
- EP and !EP. The EP bit is set to ensure even parity on the data-word D[8:0]. Even parity means there is always an even number of 1s within the D[8:0] bit arrangement. This includes the EP bit. !EP describes the logic inverse of EP and is output on D[9]. The !EP is output to ensure the reserved codes of 00 and FF cannot happen.
- EF. Even field identifier. EF = 1 indicates the data was recovered from a video line on an even field.
- 2x. This bit indicates whether the data sliced was in Gemstar 1x or 2x format. A high indicates 2x format.
- line[3:0]. This entry provides a code that is unique for each of the possible 16 source lines of video from which Gemstar data can be retrieved. See Table 73 and Table 74.
- DC[1:0]. Data count value. The number of user data-words (UDW) in the packet divided by 4. The number of UDWs in any packet must be an integral number of 4. Padding is required at the end, if necessary (requirement as set in ITU-R BT.1364). See Table 64.
- The 2x bit determines whether the raw information retrieved from the video line was 2 or 4 bytes. The state of the GDECAD bit affects whether the bytes are transmitted straight (that is, two bytes transmitted as two bytes) or whether they are split into nibbles (that is, two bytes transmitted as four half bytes). Padding bytes are then added where necessary.

# ADV7181B

- CS[8:2]. The checksum is provided to determine the integrity of the ancillary data packet. It is calculated by summing up D[8:2] of DID, SDID, the data count byte, and all UDWs, and ignoring any overflow during the summation. Since all data bytes that are used to calculate the checksum have their two LSBs set to 0, the CS[1:0] bits are also always 0.

!CS[8] describes the logic inversion of CS[8]. The value !CS[8] is included in the checksum entry of the data packet to ensure the reserved values of 0x00 and 0xFF do not occur.

## Gemstar 2× Format, Half-Byte Output Mode

Half-byte output mode is selected by setting CDECAD = 0; full-byte output mode is selected by setting CDECAD = 1. See the GDECAD Gemstar Decode Ancillary Data Format, Address 0x4C[0] section.

## Gemstar 1× Format

Half-byte output mode is selected by setting CDECAD = 0; full-byte output mode is selected by setting CDECAD = 1. See the GDECAD Gemstar Decode Ancillary Data Format, Address 0x4C[0] section.

Table 65 to Table 68 outline the possible data packages.

**Table 65. Gemstar 2× Data, Half-Byte Mode**

Byte	D[9]	D[8]	D[7]	D[6]	D[5]	D[4]	D[3]	D[2]	D[1]	D[0]	Description
0	0	0	0	0	0	0	0	0	0	0	Fixed preamble
1	1	1	1	1	1	1	1	1	1	1	Fixed preamble
2	1	1	1	1	1	1	1	1	1	1	Fixed preamble
3	0	1	0	1	0	0	0	0	0	0	DID
4	!EP	EP	EF	1	Line[3:0]				0	0	SDID
5	!EP	EP	0	0	0	0	1	0	0	0	Data count
6	!EP	EP	0	0	Gemstar Word1[7:4]				0	0	User data-words
7	!EP	EP	0	0	Gemstar Word1[3:0]				0	0	User data-words
8	!EP	EP	0	0	Gemstar Word2[7:4]				0	0	User data-words
9	!EP	EP	0	0	Gemstar Word2[3:0]				0	0	User data-words
10	!EP	EP	0	0	Gemstar Word3[7:4]				0	0	User data-words
11	!EP	EP	0	0	Gemstar Word3[3:0]				0	0	User data-words
12	!EP	EP	0	0	Gemstar Word4[7:4]				0	0	User data-words
13	!EP	EP	0	0	Gemstar Word4[3:0]				0	0	User data-words
14	!CS[8]	CS[8]	CS[7]	CS[6]	CS[5]	CS[4]	CS[3]	CS[2]	CS[1]	CS[0]	Checksum

**Table 66. Gemstar 2× Data, Full-Byte Mode**

Byte	D[9]	D[8]	D[7]	D[6]	D[5]	D[4]	D[3]	D[2]	D[1]	D[0]	Description
0	0	0	0	0	0	0	0	0	0	0	Fixed preamble
1	1	1	1	1	1	1	1	1	1	1	Fixed preamble
2	1	1	1	1	1	1	1	1	1	1	Fixed preamble
3	0	1	0	1	0	0	0	0	0	0	DID
4	!EP	EP	EF	1	Line[3:0]				0	0	SDID
5	!EP	EP	0	0	0	0	0	1	0	0	Data count
6	Gemstar Word1[7:0]								0	0	User data-words
7	Gemstar Word2[7:0]								0	0	User data-words
8	Gemstar Word3[7:0]								0	0	User data-words
9	Gemstar Word4[7:0]								0	0	User data-words
10	!CS[8]	CS[8]	CS[7]	CS[6]	CS[5]	CS[4]	CS[3]	CS[2]	CS[1]	CS[0]	Checksum

Table 67. Gemstar 1× Data, Half-Byte Mode

Byte	D[9]	D[8]	D[7]	D[6]	D[5]	D[4]	D[3]	D[2]	D[1]	D[0]	Description
0	0	0	0	0	0	0	0	0	0	0	Fixed preamble
1	1	1	1	1	1	1	1	1	1	1	Fixed preamble
2	1	1	1	1	1	1	1	1	1	1	Fixed preamble
3	0	1	0	1	0	0	0	0	0	0	DID
4	!EP	EP	EF	<b>0</b>	Line[3:0]				0	0	SDID
5	!EP	EP	0	0	0	0	<b>0</b>	<b>1</b>	0	0	Data count
6	!EP	EP	0	0	Gemstar Word1[7:4]				0	0	User data-words
7	!EP	EP	0	0	Gemstar Word1[3:0]				0	0	User data-words
8	!EP	EP	0	0	Gemstar Word2[7:4]				0	0	User data-words
9	!EP	EP	0	0	Gemstar Word2[3:0]				0	0	User data-words
10	!CS[8]	CS[8]	CS[7]	CS[6]	CS[5]	CS[4]	CS[3]	CS[2]	CS[1]	CS[0]	Checksum

Table 68. Gemstar 1× Data, Full-Byte Mode

Byte	D[9]	D[8]	D[7]	D[6]	D[5]	D[4]	D[3]	D[2]	D[1]	D[0]	Description
0	0	0	0	0	0	0	0	0	0	0	Fixed preamble
1	1	1	1	1	1	1	1	1	1	1	Fixed preamble
2	1	1	1	1	1	1	1	1	1	1	Fixed preamble
3	0	1	0	1	0	0	0	0	0	0	DID
4	!EP	EP	EF	<b>0</b>	Line[3:0]				0	0	SDID
5	!EP	EP	0	0	0	0	<b>0</b>	<b>1</b>	0	0	Data count
6	Gemstar Word1[7:0]								0	0	User data-words
7	Gemstar Word2[7:0]								0	0	User data-words
8	1	0	0	0	0	0	0	0	0	0	UDW padding 0x200
9	1	0	0	0	0	0	0	0	0	0	UDW padding 0x200
10	!CS[8]	CS[8]	CS[7]	CS[6]	CS[5]	CS[4]	CS[3]	CS[2]	CS[1]	CS[0]	Checksum

Table 69. NTSC CCAP Data, Half-Byte Mode

Byte	D[9]	D[8]	D[7]	D[6]	D[5]	D[4]	D[3]	D[2]	D[1]	D[0]	Description
0	0	0	0	0	0	0	0	0	0	0	Fixed preamble
1	1	1	1	1	1	1	1	1	1	1	Fixed preamble
2	1	1	1	1	1	1	1	1	1	1	Fixed preamble
3	0	1	0	1	0	0	0	0	0	0	DID
4	!EP	EP	EF	<b>0</b>	<b>1</b>	<b>0</b>	<b>1</b>	<b>1</b>	0	0	SDID
5	!EP	EP	0	0	0	0	<b>0</b>	<b>1</b>	0	0	Data count
6	!EP	EP	0	0	CCAP Word1[7:4]				0	0	User data-words
7	!EP	EP	0	0	CCAP Word1[3:0]				0	0	User data-words
8	!EP	EP	0	0	CCAP Word2[7:4]				0	0	User data-words
9	!EP	EP	0	0	CCAP Word2[3:0]				0	0	User data-words
10	!CS[8]	CS[8]	CS[7]	CS[6]	CS[5]	CS[4]	CS[3]	CS[2]	CS[1]	CS[0]	Checksum

# ADV7181B

## NTSC CCAP Data

Half-byte output mode is selected by setting CDECAD = 0; the full-byte mode is enabled by CDECAD = 1. See the GDECAD Gemstar Decode Ancillary Data Format, Address 0x4C[0] section. The data packet formats are shown in Table 69 and Table 70.

NTSC closed caption data is sliced on Line 21d on even and odd fields. The corresponding enable bit has to be set high. See the GDECEL[15:0] Gemstar Decoding Even Lines, Address 0x48[7:0]; Address 0x49[7:0] and the GDECOL[15:0] Gemstar Decoding Odd Lines, Address 0x4A[7:0]; Address 0x4B[7:0] sections.

## PAL CCAP Data

Half-byte output mode is selected by setting CDECAD = 0; full-byte output mode is selected by setting CDECAD = 1. See the GDECAD Gemstar Decode Ancillary Data Format, Address 0x4C[0] section. Table 71 and Table 72 list the bytes of the data packet.

PAL closed caption data is sliced from Lines 22 and 335. The corresponding enable bits have to be set.

See the GDECEL[15:0] Gemstar Decoding Even Lines, Address 0x48[7:0]; Address 0x49[7:0] and the GDECOL[15:0] Gemstar Decoding Odd Lines, Address 0x4A[7:0]; Address 0x4B[7:0] sections.

**Table 70. NTSC CCAP Data, Full-Byte Mode**

Byte	D[9]	D[8]	D[7]	D[6]	D[5]	D[4]	D[3]	D[2]	D[1]	D[0]	Description	
0	0	0	0	0	0	0	0	0	0	0	Fixed preamble	
1	1	1	1	1	1	1	1	1	1	1	Fixed preamble	
2	1	1	1	1	1	1	1	1	1	1	Fixed preamble	
3	0	1	0	1	0	0	0	0	0	0	DID	
4	!EP	EP	EF	0	1	0	1	1	0	0	SDID	
5	!EP	EP	0	0	0	0	0	1	0	0	Data count	
6	CCAP Word1[7:0]									0	0	User data-words
7	CCAP Word2[7:0]									0	0	User data-words
8	1	0	0	0	0	0	0	0	0	0	UDW padding 0x200	
9	1	0	0	0	0	0	0	0	0	0	UDW padding 0x200	
10	!CS[8]	CS[8]	CS[7]	CS[6]	CS[5]	CS[4]	CS[3]	CS[2]	CS[1]	CS[0]	Checksum	

**Table 71. PAL CCAP Data, Half-Byte Mode**

Byte	D[9]	D[8]	D[7]	D[6]	D[5]	D[4]	D[3]	D[2]	D[1]	D[0]	Description
0	0	0	0	0	0	0	0	0	0	0	Fixed preamble
1	1	1	1	1	1	1	1	1	1	1	Fixed preamble
2	1	1	1	1	1	1	1	1	1	1	Fixed preamble
3	0	1	0	1	0	0	0	0	0	0	DID
4	!EP	EP	EF	0	1	0	1	0	0	0	SDID
5	!EP	EP	0	0	0	0	0	1	0	0	Data count
6	!EP	EP	0	0	CCAP Word1[7:4]				0	0	User data-words
7	!EP	EP	0	0	CCAP Word1[3:0]				0	0	User data-words
8	!EP	EP	0	0	CCAP Word2[7:4]				0	0	User data-words
9	!EP	EP	0	0	CCAP Word2[3:0]				0	0	User data-words
10	!CS[8]	CS[8]	CS[7]	CS[6]	CS[5]	CS[4]	CS[3]	CS[2]	CS[1]	CS[0]	Checksum

Table 72. PAL CCAP Data, Full-Byte Mode

Byte	D[9]	D[8]	D[7]	D[6]	D[5]	D[4]	D[3]	D[2]	D[1]	D[0]	Description	
0	0	0	0	0	0	0	0	0	0	0	Fixed preamble	
1	1	1	1	1	1	1	1	1	1	1	Fixed preamble	
2	1	1	1	1	1	1	1	1	1	1	Fixed preamble	
3	0	1	0	1	0	0	0	0	0	0	DID	
4	!EP	EP	EF	<b>0</b>	<b>1</b>	<b>0</b>	<b>1</b>	<b>0</b>	0	0	SDID	
5	!EP	EP	0	0	0	0	<b>0</b>	<b>1</b>	0	0	Data count	
6	CCAP Word1[7:0]									0	0	User data-words
7	CCAP Word2[7:0]									0	0	User data-words
8	1	0	0	0	0	0	0	0	0	0	UDW padding 0x200	
9	1	0	0	0	0	0	0	0	0	0	UDW padding 0x200	
10	!CS[8]	CS[8]	CS[7]	CS[6]	CS[5]	CS[4]	CS[3]	CS[2]	CS[1]	CS[0]	Checksum	

#### GDECEL[15:0] Gemstar Decoding Even Lines, Address 0x48[7:0]; Address 0x49[7:0]

The 16 bits of the GDECEL[15:0] are interpreted as a collection of 16 individual line decode enable signals. Each bit refers to a line of video in an even field. Setting the bit enables the decoder block trying to find Gemstar or closed caption-compatible data on that particular line. Setting the bit to 0 prevents the decoder from trying to retrieve data. See Table 73 and Table 74.

To retrieve closed caption data services on NTSC (Line 284), GDECEL[11] must be set.

To retrieve closed caption data services on PAL (Line 335), GDECEL[14] must be set.

The default value of GDECEL[15:0] is 0x0000. This setting instructs the decoder not to attempt to decode Gemstar or CCAP data from any line in the even field.

#### GDECOL[15:0] Gemstar Decoding Odd Lines, Address 0x4A[7:0]; Address 0x4B[7:0]

The 16 bits of the GDECOL[15:0] form a collection of 16 individual line decode enable signals. See Table 73 and Table 74.

To retrieve closed caption data services on NTSC (Line 21), GDECOL[11] must be set.

To retrieve closed caption data services on PAL (Line 22), GDECOL[14] must be set.

The default value of GDECOL[15:0] is 0x0000. This setting instructs the decoder not to attempt to decode Gemstar or CCAP data from any line in the odd field.

#### GDECAD Gemstar Decode Ancillary Data Format, Address 0x4C[0]

The decoded data from Gemstar-compatible transmissions or closed caption transmissions is inserted into the horizontal blanking period of the respective line of video. A potential problem can arise if the retrieved data bytes have the value 0x00 or 0xFF. In an ITU-R BT.656-compatible data stream, those values are reserved and used only to form a fixed preamble.

The GDECAD bit allows the data to be inserted into the horizontal blanking period in two ways

- Insert all data straight into the data stream, even the reserved values of 0x00 and 0xFF, if they occur. This can violate the output data format specification ITU-R BT.1364.
- Split all data into nibbles and insert the half-bytes over double the number of cycles in a 4-bit format.

When GDECAD is 0, the data is split into half-bytes and inserted (default).

When GDECAD is 1, the data is output straight in 8-bit format.

# ADV7181B

Table 73. NTSC Line Enable Bits and Corresponding Line Numbering

Line[3:0]	Line Number (ITU-R BT.470)	Enable Bit	Comment
0	10	GDECOL[0]	Gemstar
1	11	GDECOL[1]	Gemstar
2	12	GDECOL[2]	Gemstar
3	13	GDECOL[3]	Gemstar
4	14	GDECOL[4]	Gemstar
5	15	GDECOL[5]	Gemstar
6	16	GDECOL[6]	Gemstar
7	17	GDECOL[7]	Gemstar
8	18	GDECOL[8]	Gemstar
9	19	GDECOL[9]	Gemstar
10	20	GDECOL[10]	Gemstar
11	21	GDECOL[11]	Gemstar or closed caption
12	22	GDECOL[12]	Gemstar
13	23	GDECOL[13]	Gemstar
14	24	GDECOL[14]	Gemstar
15	25	GDECOL[15]	Gemstar
0	273 (10)	GDECEL[0]	Gemstar
1	274 (11)	GDECEL[1]	Gemstar
2	275 (12)	GDECEL[2]	Gemstar
3	276 (13)	GDECEL[3]	Gemstar
4	277 (14)	GDECEL[4]	Gemstar
5	278 (15)	GDECEL[5]	Gemstar
6	279 (16)	GDECEL[6]	Gemstar
7	280 (17)	GDECEL[7]	Gemstar
8	281 (18)	GDECEL[8]	Gemstar
9	282 (19)	GDECEL[9]	Gemstar
10	283 (20)	GDECEL[10]	Gemstar
11	284 (21)	GDECEL[11]	Gemstar or closed caption
12	285 (22)	GDECEL[12]	Gemstar
13	286 (23)	GDECEL[13]	Gemstar
14	287 (24)	GDECEL[14]	Gemstar
15	288 (25)	GDECEL[15]	Gemstar

Table 74. PAL Line Enable Bits and Corresponding Line Numbering

Line[3:0]	Line Number (ITU-R BT.470)	Enable Bit	Comment
12	8	GDECOL[0]	Not valid
13	9	GDECOL[1]	Not valid
14	10	GDECOL[2]	Not valid
15	11	GDECOL[3]	Not valid
0	12	GDECOL[4]	Not valid
1	13	GDECOL[5]	Not valid
2	14	GDECOL[6]	Not valid
3	15	GDECOL[7]	Not valid
4	16	GDECOL[8]	Not valid
5	17	GDECOL[9]	Not valid
6	18	GDECOL[10]	Not valid
7	19	GDECOL[11]	Not valid
8	20	GDECOL[12]	Not valid
9	21	GDECOL[13]	Not valid
<b>10</b>	<b>22</b>	<b>GDECOL[14]</b>	<b>Closed caption</b>
11	23	GDECOL[15]	Not valid
12	321 (8)	GDECEL[0]	Not valid
13	322 (9)	GDECEL[1]	Not valid
14	323 (10)	GDECEL[2]	Not valid
15	324 (11)	GDECEL[3]	Not valid
0	325 (12)	GDECEL[4]	Not valid
1	326 (13)	GDECEL[5]	Not valid
2	327 (14)	GDECEL[6]	Not valid
3	328 (15)	GDECEL[7]	Not valid
4	329 (16)	GDECEL[8]	Not valid
5	330 (17)	GDECEL[9]	Not valid
6	331 (18)	GDECEL[10]	Not valid
7	332 (19)	GDECEL[11]	Not valid
8	333 (20)	GDECEL[12]	Not valid
9	334 (21)	GDECEL[13]	Not valid
<b>10</b>	<b>335 (22)</b>	<b>GDECEL[14]</b>	<b>Closed caption</b>
11	336 (23)	GDECEL[15]	Not valid



### IF Compensation Filter

#### IF FILTSEL[2:0] IF Filter Select Address 0xF8[2:0]

The IF FILTSEL[2:0] register allows the user to compensate for SAW filter characteristics on a composite input as would be observed on tuner outputs. Figure 35 and Figure 36 show IF filter compensation for NTSC and PAL.

The options for this feature are as follows:

- Bypass mode (default)
- NTSC—consists of three filter characteristics
- PAL—consists of three filter characteristics

See Table 85 for programming details.

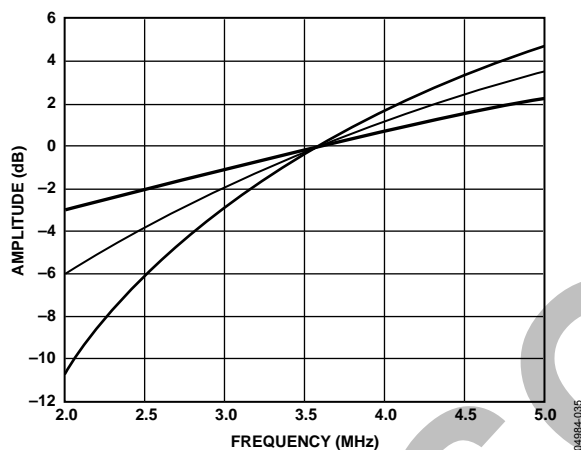

Figure 35. NTSC IF Compensation Filter Responses

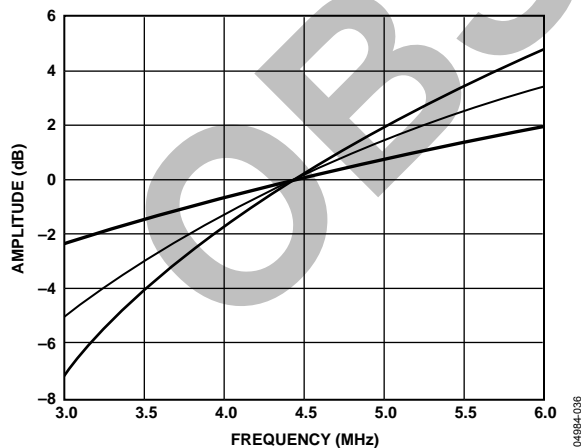

Figure 36. PAL IF Compensation Filter Responses

### I<sup>2</sup>C Interrupt System

The ADV7181B has a comprehensive interrupt register set. This map is located in Register Access Page 2. See Table 83 or details of the interrupt register map.

Steps to access this map are presented in Figure 37.

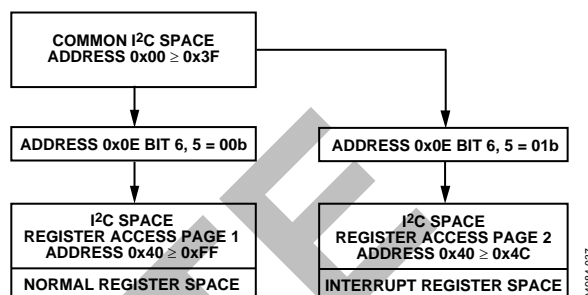

Figure 37. Register Access, Page 1 and Page 2

### Interrupt Request Output Operation

When an interrupt event occurs, the interrupt pin  $\overline{\text{INTRQ}}$  goes low with a programmable duration given by INTRQ\_DUR\_SEL[1:0]

#### INTRQ\_DURSEL[1:0], Interrupt Duration Select Address 0x40 (Interrupt Space)[7:6]

Table 75. INTRQ\_DUR\_SEL

INTRQ_DURSEL[1:0]	Description
00	3 Xtal periods (default)
01	15 Xtal periods
10	63 Xtal periods
11	Active until cleared

When the active until cleared interrupt duration is selected and the event that caused the interrupt is no longer in force, the interrupt persists until it is masked or cleared.

For example, if the ADV7181B loses lock, an interrupt is generated and the  $\overline{\text{INTRQ}}$  pin goes low. If the ADV7181B returns to the locked state,  $\overline{\text{INTRQ}}$  continues to drive low until the SD\_LOCK bit is either masked or cleared.

### Interrupt Drive Level

The ADV7181B resets with open drain enabled and all interrupts masked off. Therefore,  $\overline{\text{INTRQ}}$  is in a high impedance state after reset. 01 or 10 must be written to INTRQ\_OP\_SEL[1:0] for a logic level to be driven out from the  $\overline{\text{INTRQ}}$  pin.

It is also possible to write to a register in the ADV7181B that manually asserts the  $\overline{\text{INTRQ}}$  pin. This bit is MPU\_STIM\_INTRQ.

# ADV7181B

**INTRQ\_OP\_SEL[1:0], Interrupt Duration Select  
Address 0x40 (Interrupt Space)[1:0]**

**Table 76. INTRQ\_OP\_SEL**

<b>INTRQ_OP_SEL[1:0]</b>	<b>Description</b>
00	Open drain (default)
01	Drive low when active
10	Drive high when active
11	Reserved

## Multiple Interrupt Events

If Interrupt Event 1 occurs and then Interrupt Event 2 occurs before the system controller has cleared or masked Interrupt Event 1, the ADV7181B does not generate a second interrupt signal. The system controller should check all unmasked interrupt status bits since more than one can be active.

## Macrovision Interrupt Selection Bits

The user can select between pseudo sync pulse and color stripe detection as follows:

**MV\_INTRQ\_SEL[1:0], Macrovision Interrupt Selection Bits, Address 0x40 (Interrupt Space)[5:4]**

**Table 77. MV\_INTRQ\_SEL**

<b>MV_INTRQ_SEL[1:0]</b>	<b>Description</b>
00	Reserved
01	Pseudo sync only (default)
10	Color stripe only
11	Either pseudo sync or color stripe

Additional information relating to the interrupt system is detailed in Table 83.

OBSOLETE

## PIXEL PORT CONFIGURATION

The ADV7181B has a very flexible pixel port that can be configured in a variety of formats to accommodate downstream ICs. Table 78 and Table 79 summarize the various functions that the ADV7181B pins can have in different modes of operation.

The ordering of components, for example, Cr vs. Cb or CHA/B/C, can be changed. Refer to the SWPC Swap Pixel Cr/Cb, Address 0x27[7] section. Table 78 shows the default positions for the Cr/Cb components.

### OF\_SEL[3:0] Output Format Selection, Address 0x03[5:2]

The modes in which the ADV7181B pixel port can be configured are under the control of OF\_SEL[3:0]. See Table 79 for details.

The default LLC frequency output on the LLC1 pin is approximately 27 MHz. For modes that operate with a nominal data rate of 13.5 MHz (0001, 0010), the clock frequency on the LLC1 pin stays at the higher rate of 27 MHz. For information on outputting the nominal 13.5 MHz clock on the LLC1 pin, see the LLC1 Output Selection, LLC\_PAD\_SEL[2:0], Address 0x8F[6:4] section.

### SWPC Swap Pixel Cr/Cb, Address 0x27[7]

This bit allows Cr and Cb samples to be swapped.

When SWPC is 0 (default), no swapping is allowed.

When SWPC is 1, the Cr and Cb values can be swapped.

### LLC1 Output Selection, LLC\_PAD\_SEL[2:0], Address 0x8F[6:4]

The following I<sup>2</sup>C write allows the user to select between the LLC1 (nominally at 27 MHz) and LLC2 (nominally at 13.5 MHz).

The LLC2 signal is useful for LLC2-compatible wide bus (16-bit) output modes. See the OF\_SEL[3:0] Output Format Selection, Address 0x03[5:2] section for additional information. The LLC2 signal and data on the data bus are synchronized. By default, the rising edge of LLC1/LLC2 is aligned with the Y data; the falling edge occurs when the data bus holds C data. The polarity of the clock, and therefore the Y/C assignments to the clock edges, can be altered by using the polarity LLC pin.

When LLC\_PAD\_SEL is 000, the output is nominally 27 MHz LLC on the LLC1 pin (default).

When LLC\_PAD\_SEL is 101, the output is nominally 13.5 MHz LLC on the LLC1 pin.

**Table 78. P15–P0 Output/Input Pin Mapping**

Format and Mode	Data Port Pins P[15:0]															
	15	14	13	12	11	10	9	8	7	6	5	4	3	2	1	0
Video Out, 8-Bit, 4:2:2	YCrCb[7:0] OUT															
Video Out, 16-Bit, 4:2:2	Y[7:0] OUT								CrCb[7:0] OUT							

**Table 79. Standard Definition Pixel Port Modes**

OF_SEL[3:0]	Format	P[15:0]	
		P[15:8]	P[7:0]
0010	16-bit @ LLC2 4:2:2	Y[7:0]	CrCb[7:0]
0011	8-bit @ LLC1 4:2:2 (default)	YCrCb[7:0]	Three-state
0110-1111	Reserved	Reserved	

## MPU PORT DESCRIPTION

The ADV7181B supports a 2-wire (I<sup>2</sup>C-compatible) serial interface. Two inputs, serial data (SDA) and serial clock (SCLK), carry information between the ADV7181B and the system I<sup>2</sup>C master controller. Each slave device is recognized by a unique address. The ADV7181B's I<sup>2</sup>C port allows the user to set up and configure the decoder and to read back captured VBI data. The ADV7181B has four possible slave addresses for both read and write operations, depending on the logic level on the ALSB pin. These four unique addresses are shown in Table 80. The ADV7181B's ALSB pin controls Bit 1 of the slave address. By altering the ALSB, it is possible to control two ADV7181Bs in an application without having a conflict with the same slave address. The LSB (Bit 0) sets either a read or write operation. Logic 1 corresponds to a read operation; Logic 0 corresponds to a write operation.

**Table 80. I<sup>2</sup>C Address for ADV7181B**

ALSB	R/W	Slave Address
0	0	0x40
0	1	0x41
1	0	0x42
1	1	0x43

To control the device on the bus, a specific protocol must be followed. First, the master initiates a data transfer by establishing a start condition, which is defined by a high-to-low transition on SDA while SCLK remains high. This indicates that an address/data stream follows. All peripherals respond to the start condition and shift the next eight bits (7-bit address + R/W bit). The bits are transferred from MSB down to LSB. The peripheral that recognizes the transmitted address responds by pulling the data line low during the ninth clock pulse; this is known as an acknowledge bit. All other devices withdraw from the bus at this point and maintain an idle condition. The idle condition is where the device monitors the SDA and SCLK lines, waiting for the start condition and the correct transmitted address. The R/W bit determines the direction of the data.

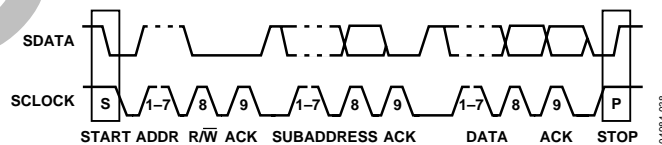

Figure 38. Bus Data Transfer

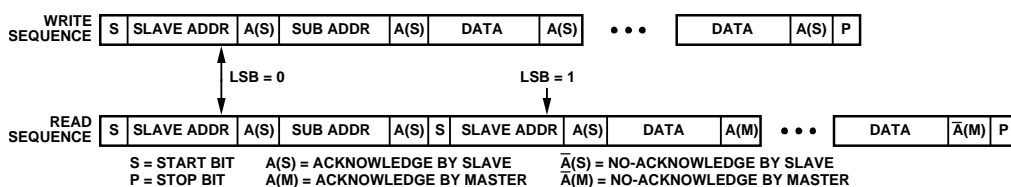

Figure 39. Read and Write Sequence

Logic 0 on the LSB of the first byte means that the master writes information to the peripheral. Logic 1 on the LSB of the first byte means that the master reads information from the peripheral.

The ADV7181B acts as a standard slave device on the bus. The data on the SDA pin is eight bits long, supporting the 7-bit addresses plus the R/W bit. The ADV7181B has 249 subaddresses to enable access to the internal registers. It therefore interprets the first byte as the device address and the second byte as the starting subaddress. The subaddresses auto-increment, allowing data to be written to or read from the starting subaddress. A data transfer is always terminated by a stop condition. The user can also access any unique subaddress register on a one-by-one basis without updating all the registers.

Stop and start conditions can be detected at any stage during the data transfer. If these conditions are asserted out of sequence with normal read and write operations, they cause an immediate jump to the idle condition. During a given SCLK high period, the user should only issue one start condition, one stop condition, or a single stop condition followed by a single start condition. If an invalid subaddress is issued by the user, the ADV7181B does not issue an acknowledge and returns to the idle condition.

If in auto-increment mode the user exceeds the highest subaddress, the following occurs:

- In read mode, the highest subaddress register contents continue to be output until the master device issues a no acknowledge. This indicates the end of a read. A no acknowledge condition is when the SDA line is not pulled low on the ninth pulse.
- In write mode, the data for the invalid byte is not loaded into any subaddress register, a no acknowledge is issued by the ADV7181B, and the part returns to the idle condition.

## REGISTER ACCESSES

The MPU can write to or read from all of the ADV7181B's registers, except the subaddress register, which is write only. The subaddress register determines which register the next read or write operation accesses. All communications with the part through the bus start with an access to the subaddress register. Then, a read/write operation is performed from/to the target address, which then increments to the next address until a stop command on the bus is performed.

## REGISTER PROGRAMMING

The following sections describe the configuration of each register. The communications register is an 8-bit, write only register. After the part has been accessed over the bus and a read/write operation is selected, the subaddress is set up. The subaddress register determines to/from which register the operation takes place. Table 82 lists the various operations under the control of the subaddress register for the control port.

### **Register Select (SR to SR0)**

These bits are set up to point to the required starting address.

## I<sup>2</sup>C SEQUENCER

An I<sup>2</sup>C sequencer is used when a parameter exceeds eight bits and is, therefore, distributed over two or more I<sup>2</sup>C registers, for example, HSB[11:0].

When a parameter is changed using two or more I<sup>2</sup>C write operations, the parameter can hold an invalid value for the time between the first I<sup>2</sup>C completion and the last I<sup>2</sup>C completion. This means that the top bits of the parameter can already hold the new value while the remaining bits of the parameter still hold the previous value.

To avoid this problem, the I<sup>2</sup>C sequencer holds the already updated bits of the parameter in local memory; all bits of the parameter are updated together once the last register write operation has completed.

The correct operation of the I<sup>2</sup>C sequencer relies on the following:

- All I<sup>2</sup>C registers for the parameter in question must be written to in order of ascending addresses. For example, for HSB[10:0], write to Address 0x34 first, followed by 0x35.
- No other I<sup>2</sup>C taking place between the two (or more) I<sup>2</sup>C writes for the sequence. For example, for HSB[10:0], write to Address 0x34 first, immediately followed by 0x35.

## I<sup>2</sup>C REGISTER MAPS

Table 81. Common and Normal (Page 1) Register Map Details

Register Name	Reset Value	rw	Dec	Subaddress	
				Dec	Hex
Input Control	0000 0000	rw	0		0x00
Video Selection	1100 1000	rw	1		0x01
Reserved	0000 0100	rw	2		0x02
Output Control	0000 1100	rw	3		0x03
Extended Output Control	01xx 0101	rw	4		0x04
Reserved	0000 0000	rw	5		0x05
Reserved	0000 0010	rw	6		0x06
Autodetect Enable	0111 1111	rw	7		0x07
Contrast	1000 0000	rw	8		0x08
Reserved	1000 0000	rw	9		0x09
Brightness	0000 0000	rw	10		0x0A
Hue	0000 0000	rw	11		0x0B
Default Value Y	0011 0110	rw	12		0x0C
Default Value C	0111 1100	rw	13		0x0D
ADI Control	0000 0000	rw	14		0x0E
Power Management	0000 0000	rw	15		0x0F
Status 1	xxxx xxxx	r	16		0x10
Ident	xxxx xxxx	r	17		0x11
Status 2	xxxx xxxx	r	18		0x12
Status 3	xxxx xxxx	r	19		0x13
Analog Clamp Control	0001 0010	rw	20		0x14
Digital Clamp Control 1	0100 xxxx	rw	21		0x15
Reserved	xxxx xxxx	rw	22		0x16
Shaping Filter Control	0000 0001	rw	23		0x17
Shaping Filter Control 2	1001 0011	rw	24		0x18
Comb Filter Control	1111 0001	rw	25		0x19
Reserved	xxxx xxxx	rw	26 to 28		0x1A to 0x1C
ADI Control 2	0000 0xxx	rw	29		0x1D
Reserved	xxxx xxxx	rw	30 to 38		0x1E to 0x26
Pixel Delay Control	0101 1000	rw	39		0x27
Reserved	xxxx xxxx	rw	40 to 42		0x28 to 0x2A
Misc Gain Control	1110 0001	rw	43		0x2B
AGC Mode Control	1010 1110	rw	44		0x2C
Chroma Gain Control 1	1111 0100	rw	45		0x2D
Chroma Gain Control 2	0000 0000	rw	46		0x2E
Luma Gain Control 1	1111 xxxx	rw	47		0x2F
Luma Gain Control 2	xxxx xxxx	rw	48		0x30
Vsync Field Control 1	0001 0010	rw	49		0x31
Vsync Field Control 2	0100 0001	rw	50		0x32
Vsync Field Control 3	1000 0100	rw	51		0x33
Hsync Position Control 1	0000 0000	rw	52		0x34
Hsync Position Control 2	0000 0010	rw	53		0x35
Hsync Position Control 3	0000 0000	rw	54		0x36
Polarity	0000 0001	rw	55		0x37
NTSC Comb Control	1000 0000	rw	56		0x38
PAL Comb Control	1100 0000	rw	57		0x39
ADC Control	0001 0000	rw	58		0x3A
Reserved	xxxx xxxx	rw	59 to 60		0x3B to 0x3C
Manual Window Control	0100 0011	rw	61		0x3D

Register Name	Reset Value	rw	Dec	Subaddress	
				Hex	
Reserved	xxxx xxxx	rw	62 to 64	0x3E to 0x40	
Resample Control	0100 0001	rw	65	0x41	
Reserved	xxxx xxxx	rw	66 to 71	0x42 to 0x47	
Gemstar Ctrl 1	00000000	rw	72	0x48	
Gemstar Ctrl 2	0000 0000	rw	73	0x49	
Gemstar Ctrl 3	0000 0000	rw	74	0x4A	
Gemstar Ctrl 4	0000 0000	rw	75	0x4B	
GemStar Ctrl 5	xxxx xxx0	rw	76	0x4C	
CTI DNR Ctrl 1	1110 1111	rw	77	0x4D	
CTI DNR Ctrl 2	0000 1000	rw	78	0x4E	
Reserved	xxxx xxxx	rw	79	0x4F	
CTI DNR Ctrl 4	0000 1000	rw	80	0x50	
Lock Count	0010 0100	rw	81	0x51	
Reserved	xxxx xxxx	rw	82 to 142	0x52 to 0x8E	
Free-Run Line Length 1	0000 0000	w	143	0x8F	
Reserved	0000 0000	w	144	0x90	
VBI Info	xxxx xxxx	r	144	0x90	
WSS 1	xxxx xxxx	r	145	0x91	
WSS 2	xxxx xxxx	r	146	0x92	
EDTV 1	xxxx xxxx	r	147	0x93	
EDTV 2	xxxx xxxx	r	148	0x94	
EDTV 3	xxxx xxxx	r	149	0x95	
CGMS 1	xxxx xxxx	r	150	0x96	
CGMS 2	xxxx xxxx	r	151	0x97	
CGMS 3	xxxx xxxx	r	152	0x98	
CCAP 1	xxxx xxxx	r	153	0x99	
CCAP 2	xxxx xxxx	r	154	0x9A	
Letterbox 1	xxxx xxxx	r	155	0x9B	
Letterbox 2	xxxx xxxx	r	156	0x9C	
Letterbox 3	xxxx xxxx	r	157	0x9D	
Reserved	xxxx xxxx	rw	158 to 177	0x9E to 0xB1	
CRC Enable	0001 1100	w	178	0xB2	
Reserved	xxxx xxxx	rw	179 to 194	0xB2 to 0xC2	
ADC Switch 1	xxxx xxxx	rw	195	0xC3	
ADC Switch 2	0xxx xxxx	rw	196	0xC4	
Reserved	xxxx xxxx	rw	197 to 219	0xC5 to 0xDB	
Letterbox Control 1	1010 1100	rw	220	0xDC	
Letterbox Control 2	0100 1100	rw	221	0xDD	
Reserved	0000 0000	rw	222	0xDE	
Reserved	0000 0000	rw	223	0xDF	
Reserved	0001 0100	rw	224	0xE0	
SD Offset Cb	1000 0000	rw	225	0xE1	
SD Offset Cr	1000 0000	rw	226	0xE2	
SD Saturation Cb	1000 0000	rw	227	0xE3	
SD Saturation Cr	1000 0000	rw	228	0xE4	
NTSC V Bit Begin	0010 0101	rw	229	0xE5	
NTSC V Bit End	0000 0100	rw	230	0xE6	
NTSC F Bit Toggle	0110 0011	rw	231	0xE7	
PAL V Bit Begin	0110 0101	rw	232	0xE8	
PAL V Bit End	0001 0100	rw	233	0xE9	
PAL F Bit Toggle	0110 0011	rw	234	0xEA	
Reserved	xxxx xxxx	rw	235 to 243	0xEB to 0xF3	

# ADV7181B

Register Name	Reset Value	rw	Dec	Subaddress	
				Hex	
Drive Strength	xx01 0101	rw	244	0xF4	
Reserved	xxxx xxxx	rw	245-247	0xF5-0xF7	
IF Comp Control	0000 0000	rw	248	0xF8	
VS Mode Control	0000 0000	rw	249	0xF9	

**Table 82. Common and Normal (Page 1) Register Map Bit Names**

Register Name	Bit 7	Bit 6	Bit 5	Bit 4	Bit 3	Bit 2	Bit 1	Bit 0
Input Control	VID_SEL.3	VID_SEL.2	VID_SEL.1	VID_SEL.0	INSEL.3	INSEL.2	INSEL.1	INSEL.0
Video Selection		ENHSPLL	BETACAM		ENVSPROC			
Reserved								
Output Control	VBI_EN	TOD	OF_SEL.3	OF_SEL.2	OF_SEL.1	OF_SEL.0		SD_DUP_AV
Extended Output Control	BT656-4				TIM_OE	BL_C_VBI	EN_SFL_PI	RANGE
Reserved								
Reserved								
Autodetect Enable	AD_SECS25_EN	AD_SECAM_EN	AD_N443_EN	AD_P60_EN	AD_PALN_EN	AD_PALM_EN	AD_NTSC_EN	AD_PAL_EN
Contrast	CON.7	CON.6	CON.5	CON.4	CON.3	CON.2	CON.1	CON.0
Reserved								
Brightness	BRI.7	BRI.6	BRI.5	BRI.4	BRI.3	BRI.2	BRI.1	BRI.0
Hue	HUE.7	HUE.6	HUE.5	HUE.4	HUE.3	HUE.2	HUE.1	HUE.0
Default Value Y	DEF_Y.5	DEF_Y.4	DEF_Y.3	DEF_Y.2	DEF_Y.1	DEF_Y.0	DEF_VAL_AUTO_EN	DEF_VAL_EN
Default Value C	DEF_C.7	DEF_C.6	DEF_C.5	DEF_C.4	DEF_C.3	DEF_C.2	DEF_C.1	DEF_C.0
ADI Control				SUB_USR_EN.0				
Power Management	RES		PWRDN			PDBP		
Status 1	COL_KILL	AD_RESULT.2	AD_RESULT.1	AD_RESULT.0	FOLLOW_PW	FSC_LOCK	LOST_LOCK	IN_LOCK
Ident	IDENT.7	IDENT.6	IDENT.5	IDENT.4	IDENT.3	IDENT.2	IDENT.1	IDENT.0
Status 2			FSC NSTD	LL NSTD	MV AGC DET	MV PS DET	MVCS T3	MVCS DET
Status 3	PAL SW LOCK	INTERLACE	STD_FLD_LEN	FREE_RUN_ACT		SD_OP_50 Hz	GEMD	INST_HLOCK
Analog Clamp Control				CCLEN				
Digital Clamp Control 1		DCT.1	DCT.0					
Reserved								
Shaping Filter Control	CSFM.2	CSFM.1	CSFM.0	YSFM.4	YSFM.3	YSFM.2	YSFM.1	YSFM.0
Shaping Filter Control 2	WYSFMOVR			WYSFM.4	WYSFM.3	WYSFM.2	WYSFM.1	WYSFM.0
Comb Filter Control					NSFSEL.1	NSFSEL.0	PSFSEL.1	PSFSEL.0
Reserved								
ADI Control 2	TRI_LLC	EN28XTAL	VS_JIT_COMP_EN					
Reserved								
Pixel Delay Control	SWPC	AUTO_PDC_EN	CTA.2	CTA.1	CTA.0		LTA.1	LTA.0
Reserved								
Misc Gain Control		CKE						PW_UPD
AGC Mode Control		LAGC.2	LAGC.1	LAGC.0			CAGC.1	CAGC.0
Chroma Gain Control 1	CAGT.1	CAGT.0			CMG.11	CMG.10	CMG.9	CMG.8
Chroma Gain Control 2	CMG.7	CMG.6	CMG.5	CMG.4	CMG.3	CMG.2	CMG.1	CMG.0
Luma Gain Control 1	LAGT.1	LGAT.0			LMG.11	LMG.10	LMG.9	LMG.8



Register Name	Bit 7	Bit 6	Bit 5	Bit 4	Bit 3	Bit 2	Bit 1	Bit 0
Luma Gain Control 2	LMG.7	LMG.6	LMG.5	LMG.4	LMG.3	LMG.2	LMG.1	LMG.0
Vsync Field Control 1				NEWAVMODE	HVSTIM			
Vsync Field Control 2	VSBHO	VSBHE						
Vsync Field Control 3	VSEHO	VSEHE						
Hsync Position Control 1		HSB.10	HSB.9	HSB.8		HSE.10	HSE.9	HSE.8
Hsync Position Control 2	HSB.7	HSB.6	HSB.5	HSB.4	HSB.3	HSB.2	HSB.1	HSB.0
Hsync Position Control 3	HSE.7	HSE.6	HSE.5	HSE.4	HSE.3	HSE.2	HSE.1	HSE.0
Polarity	PHS		PVS		PF			PCLK
NTSC Comb Control	CTAPSN.1	CTAPSN.0	CCMN.2	CCMN.1	CCMN.0	YCMN.2	YCMN.1	YCMN.0
PAL Comb Control	CTAPSP.1	CTAPSP.0	CCMP.2	CCMP.1	CCMP.0	YCMP.2	YCMP.1	YCMP.0
ADC Control					PWRDN_ADC_0	PWRDN_ADC_1	PWRDN_ADC_2	
Reserved								
Manual Window Control		CKILLTHR.2	CKILLTHR.1	CKILLTHR.0				
Reserved								
Resample Control		SFL_INV						
Reserved								
Gemstar Ctrl 1	GDECEL.15	GDECEL.14	GDECEL.13	GDECEL.12	GDECEL.11	GDECEL.10	GDECEL.9	GDECEL.8
Gemstar Ctrl 2	GDECEL.7	GDECEL.6	GDECEL.5	GDECEL.4	GDECEL.3	GDECEL.2	GDECEL.1	GDECEL.0
Gemstar Ctrl 3	GDECOL.15	GDECOL.14	GDECOL.13	GDECOL.12	GDECOL.11	GDECOL.10	GDECOL.9	GDECOL.8
Gemstar Ctrl 4	GDECOL.7	GDECOL.6	GDECOL.5	GDECOL.4	GDECOL.3	GDECOL.2	GDECOL.1	GDECOL.0
Gemstar Ctrl 5								GDECAD
CTI DNR Ctrl 1			DNR_EN		CTI_AB.1	CTI_AB.0	CTI_AB_EN	CTI_EN
CTI DNR Ctrl 2	CTI_C_TH.7	CTI_C_TH.6	CTI_C_TH.5	CTI_C_TH.4	CTI_C_TH.3	CTI_C_TH.2	CTI_C_TH.1	CTI_C_TH.0
Reserved								
CTI DNR Ctrl 4	DNR_TH.7	DNR_TH.6	DNR_TH.5	DNR_TH.4	DNR_TH.3	DNR_TH.2	DNR_TH.1	DNR_TH.0
Lock Count	FSCLE	SRLS	COL.2	COL.1	COL.0	CIL.2	CIL.1	CIL.0
Reserved								
Free Run Line Length 1		LLC_PAD_SEL.2	LLC_PAD_SEL.1	LLC_PAD_SEL.0				
Reserved								
VBI Info					CGMSD	EDTV.0	CCAPD	WSSD
WSS 1	WSS1.7	WSS1.6	WSS1.5	WSS1.4	WSS1.3	WSS1.2	WSS1.1	WSS1.0
WSS 2	WSS2.7	WSS2.6	WSS2.5	WSS2.4	WSS2.3	WSS2.2	WSS2.1	WSS2.0
EDTV 1	EDTV1.7	EDTV1.6	EDTV1.5	EDTV1.4	EDTV1.3	EDTV1.2	EDTV1.1	EDTV1.0
EDTV 2	EDTV2.7	EDTV2.6	EDTV2.5	EDTV2.4	EDTV2.3	EDTV2.2	EDTV2.1	EDTV2.0
EDTV 3	EDTV3.7	EDTV3.6	EDTV3.5	EDTV3.4	EDTV3.3	EDTV3.2	EDTV3.1	EDTV3.0
CGMS 1	CGMS1.7	CGMS1.6	CGMS1.5	CGMS1.4	CGMS1.3	CGMS1.2	CGMS1.1	CGMS1.0
CGMS 2	CGMS2.7	CGMS2.6	CGMS2.5	CGMS2.4	CGMS2.3	CGMS2.2	CGMS2.1	CGMS2.0
CGMS 3	CGMS3.7	CGMS3.6	CGMS3.5	CGMS3.4	CGMS3.3	CGMS3.2	CGMS3.1	CGMS3.0
CCAP 1	CCAP1.7	CCAP1.6	CCAP1.5	CCAP1.4	CCAP1.3	CCAP1.2	CCAP1.1	CCAP1.0
CCAP 2	CCAP2.7	CCAP2.6	CCAP2.5	CCAP2.4	CCAP2.3	CCAP2.2	CCAP2.1	CCAP2.0
Letterbox 1	LB_LCT.7	LB_LCT.6	LB_LCT.5	LB_LCT.4	LB_LCT.3	LB_LCT.2	LB_LCT.1	LB_LCT.0
Letterbox 2	LB_LCM.7	LB_LCM.6	LB_LCM.5	LB_LCM.4	LB_LCM.3	LB_LCM.2	LB_LCM.1	LB_LCM.0
Letterbox 3	LB_LCB.7	LB_LCB.6	LB_LCB.5	LB_LCB.4	LB_LCB.3	LB_LCB.2	LB_LCB.1	LB_LCB.0
Reserved								
CRC Enable						CRC_ENABLE		
Reserved								
ADC Switch 1	ADC1_SW.3	ADC1_SW.2	ADC1_SW.1	ADC1_SW.0	ADC0_SW.3	ADC0_SW.2	ADC0_SW.1	ADC0_SW.0
ADC Switch 2	ADC_SW_M AN				ADC2_SW.3	ADC2_SW.2	ADC2_SW.1	ADC2_SW.0
Reserved								

# ADV7181B

Register Name	Bit 7	Bit 6	Bit 5	Bit 4	Bit 3	Bit 2	Bit 1	Bit 0
Letterbox Control 1				LB_TH.4	LB_TH.3	LB_TH.2	LB_TH.1	LB_TH.0
Letterbox Control 2	LB_SL.3	LB_SL.2	LB_SL.1	LB_SL.0	LB_EL.3	LB_EL.2	LB_EL.1	LB_EL.0
Reserved								
Reserved								
Reserved								
SD Offset Cb	SD_OFF_CB.7	SD_OFF_CB.6	SD_OFF_CB.5	SD_OFF_CB.4	SD_OFF_CB.3	SD_OFF_CB.2	SD_OFF_CB.1	SD_OFF_CB.0
SD Offset Cr	SD_OFF_CR.7	SD_OFF_CR.6	SD_OFF_CR.5	SD_OFF_CR.4	SD_OFF_CR.3	SD_OFF_CR.2	SD_OFF_CR.1	SD_OFF_CR.0
SD Saturation Cb	SD_SAT_CB.7	SD_SAT_CB.6	SD_SAT_CB.5	SD_SAT_CB.4	SD_SAT_CB.3	SD_SAT_CB.2	SD_SAT_CB.1	SD_SAT_CB.0
SD Saturation Cr	SD_SAT_CR.7	SD_SAT_CR.6	SD_SAT_CR.5	SD_SAT_CR.4	SD_SAT_CR.3	SD_SAT_CR.2	SD_SAT_CR.1	SD_SAT_CR.0
NTSC V Bit Begin	NVBEGDEL O	NVBEGDEL E	NVBEGSIGN	NVBEG.4	NVBEG.3	NVBEG.2	NVBEG.1	NVBEG.0
NTSC V Bit End	NVENDEL O	NVENDEL E	NVENDSIGN	NVEND.4	NVEND.3	NVEND.2	NVEND.1	NVEND.0
NTSC F Bit Toggle	NFTOGDEL O	NFTOGDEL E	NFTOGSIGN	NFTOG.4	NFTOG.3	NFTOG.2	NFTOG.1	NFTOG.0
PAL V Bit Begin	PVBEGDEL O	PVBEGDEL E	PVBEGSIGN	PVBEG.4	PVBEG.3	PVBEG.2	PVBEG.1	PVBEG.0
PAL V Bit End	PVENDEL O	PVENDEL E	PVENDSIGN	PVEND.4	PVEND.3	PVEND.2	PVEND.1	PVEND.0
PAL F Bit Toggle	PFTOGDEL O	PFTOGDEL E	PFTOGSIGN	PFTOG.4	PFTOG.3	PFTOG.2	PFTOG.1	PFTOG.0
Reserved								
Drive Strength			DR_STR.1	DR_STR.0	DR_STR_C.1	DR_STR_C.0	DR_STR_S.1	DR_STR_S.0
Reserved								
IF Comp Control						IFFILTSEL.2	IFFILTSEL.1	IFFILTSEL.0
VS Mode Control					VS_COAST_MODE.1	VS_COAST_MODE.0	EXTEND_VS_MIN_FREQ	EXTEND_VS_MAX_FREQ

## I<sup>2</sup>C REGISTER MAP DETAILS

The following registers are located in Register Access Page 2.

**Table 83. Interrupt Register Map Bit Names<sup>1</sup>**

Register Name	Reset Value	rw	Subaddress		Bit 7	Bit 6	Bit 5	Bit 4	Bit 3	Bit 2	Bit 1	Bit 0
			Dec	Hex								
Interrupt Config 0	0001 x000	rw	64	0x40	INTRQ_DUR_SEL.1	INTRQ_DUR_SEL.0	MV_INTRQ_SEL.1	MV_INTRQ_SEL.0		MPU_STIM_INTRQ	INTRQ_OP_SEL.1	INTRQ_OP_SEL.0
Reserved			65	0x41								
Interrupt Status 1		r	66	0x42		MV_PS_CS_Q	SD_FR_CHNG_Q				SD_UNLOCK_Q	SD_LOCK_Q
Interrupt Clear 1	x000 0000	w	67	0x43		MV_PS_CS_CLR	SD_FR_CHNG_CLR				SD_UNLOCK_CLR	SD_LOCK_CLR
Interrupt Maskb 1	x000 0000	rw	68	0x44		MV_PS_CS_MSKB	SD_FR_CHNG_MSKB				SD_UNLOCK_MSKB	SD_LOCK_MSKB
Reserved			69	0x45								
Interrupt Status 2		r	70	0x46	MPU_STIM_INTRQ_Q				WSS_CHNGD_Q	CGMS_CHNGD_Q	GEMD_Q	CCAPD_Q
Interrupt Clear 2	0xxx 0000	w	71	0x47	MPU_STIM_INTRQ_CLR				WSS_CHNGD_CLR	CGMS_CHNGD_CLR	GEMD_CLR	CCAPD_CLR
Interrupt Maskb 2	0xxx 0000	rw	72	0x48	MPU_STIM_INTRQ_MSKB				WSS_CHNGD_MSKB	CGMS_CHNGD_MSKB	GEMD_MSKB	CCAPD_MSKB
Raw Status 3		r	73	0x49				SCM_LOCK		SD_H_LOCK	SD_V_LOCK	SD_OP_50HZ
Interrupt Status 3		r	74	0x4A		PAL_SW_LK_CHNG_Q	SCM_LOCK_CHNG_Q	SD_AD_CHNG_Q	SD_H_LOCK_CHNG_Q	SD_H_LOCK_CHNG_Q	SD_V_LOCK_CHNG_Q	SD_OP_CHNG_Q
Interrupt Clear 3	xx00 0000	w	75	0x4B		PAL_SW_LK_CHNG_CLR	SCM_LOCK_CHNG_CLR	SD_AD_CHNG_CLR	SD_H_LOCK_CHNG_CLR	SD_H_LOCK_CHNG_CLR	SD_V_LOCK_CHNG_CLR	SD_OP_CHNG_CLR
Interrupt Maskb 3	xx00 0000	rw	76	0x4C		PAL_SW_LK_CHNG_MSKB	SCM_LOCK_CHNG_MSKB	SD_AD_CHNG_MSKB	SD_H_LOCK_CHNG_MSKB	SD_H_LOCK_CHNG_MSKB	SD_V_LOCK_CHNG_MSKB	SD_OP_CHNG_MSKB

<sup>1</sup> To access the Interrupt Register map, the bits of the register access page[1:0] in Register Address 0x0E must be programmed to 01b.

**Table 84. Interrupt Register Map Details**

Subaddress	Register	Bit Description	Bit								Comments	Notes
			7	6	5	4	3	2	1	0		
0x40	Interrupt Config 1	INTRQ_OP_SEL[1:0]. Interrupt Drive Level Select.							0	0	Open drain	
									0	1	Drive low when active	
								1	0	Drive high when active		
								1	1	Reserved		
	Register Access Page 2	MPU_STIM_INTRQ[1:0]. Manual Interrupt Set Mode.						0		Manual interrupt mode disabled		
								1		Manual interrupt mode enabled		
		Reserved.					x			Not used		
	MV_INTRQ_SEL[1:0]. Macrovision Interrupt Select.			0	0					Reserved		
				0	1					Pseudo sync only		
				1	0					Color stripe only		
				1	1					Pseudo sync or color stripe		
	INTRQ_DUR_SEL[1:0]. Interrupt Duration Select.		0	0						3 Xtal periods		
		0	1						15 Xtal periods			
		1	0						63 Xtal periods			
		1	1						Active until cleared			
0x41	Reserved		x	x	x	x	x	x	x			
0x42	Interrupt Status 1	SD_LOCK_Q.								0	No change	These bits can be cleared or masked in Registers 0x43 and 0x44, respectively.
										1	SD input has caused the decoder to go from an unlocked state to a locked state	
	Read Only	SD_UNLOCK_Q.							0	No change		
									1	SD input has caused the decoder to go from a locked state to an unlocked state		
	Register Access Page 2	Reserved.						x				
		Reserved.					x					
		Reserved.				x						
		SD_FR_CHNG_Q.			0					No change		
					1					Denotes a change in the free-run status		
		MV_PS_CS_Q.		0						No change		
	1							Pseudo sync/color striping detected; see MV_INTRQ_SEL[1:0], Macrovision Interrupt Selection Bits, Address 0x40 (Interrupt Space)[5:4] for selection				
	Reserved.	x										
0x43	Interrupt Clear 1	SD_LOCK_CLR.							0	Do not clear		
									1	Clears SD_LOCK_Q bit		
	Write Only	SD_UNLOCK_CLR.							0	Do not clear		
									1	Clears SD_UNLOCK_Q bit		
	Register Access Page 2	Reserved.						0		Not used		
		Reserved.					0			Not used		
		Reserved.				0				Not used		
		SD_FR_CHNG_CLR.			0					Do not clear		
					1					Clears SD_FR_CHNG_Q bit		
		MV_PS_CS_CLR.		0						Do not clear		
			1						Clears MV_PS_CS_Q bit			
		Reserved.	x							Not used		

Subaddress	Register	Bit Description	Bit							Comments	Notes	
			7	6	5	4	3	2	1			0
0x44	Interrupt Mask 1	SD_LOCK_MSKB.								0	Masks SD_LOCK_Q bit	
										1	Unmasks SD_LOCK_Q bit	
	Read/Write Register	SD_UNLOCK_MSKB.								0	Masks SD_UNLOCK_Q bit	
										1	Unmasks SD_UNLOCK_Q bit	
	Register Access Page 2	Reserved.							0		Not used	
		Reserved.					0				Not used	
		Reserved.				0					Not used	
		SD_FR_CHNG_MSKB.			0							
				1							Unmasks SD_FR_CHNG_Q bit	
MV_PS_CS_MSKB.			0								Masks MV_PS_CS_Q bit	
		1								Unmasks MV_PS_CS_Q bit		
	Reserved.	x								Not used		
0x45	Reserved		x	x	x	x	x	x	x			
0x46	Interrupt Status 2	CCAPD_Q.								0	Closed captioning not detected in the input video signal	These bits can be cleared or masked by Registers 0x47 and 0x48, respectively.
										1	Closed captioning data detected in the video input signal	
	Read Only Register	GEMD_Q.								0	Gemstar data not detected in the input video signal	
										1	Gemstar data detected in the input video signal	
	Register Access Page 2	CGMS_CHNGD_Q.								0	No change detected in CGMS data in the input video signal	
										1	A change is detected in the CGMS data in the input video signal	
		WSS_CHNGD_Q.								0	No change detected in WSS data in the input video signal	
										1	A change is detected in the WSS data in the input video signal	
		Reserved.				x					Not used	
	Reserved.			x						Not used		
	Reserved.		x							Not used		
MPU_STIM_INTRQ_Q.		0								Manual interrupt not set		
		1								Manual interrupt set		
0x47	Interrupt Clear 2	CCAPD_CLR.								0	Do not clear	
										1	Clears CCAPD_Q bit	
	Write Only	GEMD_CLR.								0	Do not clear	
										1	Clears GEMD_Q bit	
	Register Access Page 2	CGMS_CHNGD_CLR.								0	Do not clear	
										1	Clears CGMS_CHNGD_Q bit	
		WSS_CHNGD_CLR.								0	Do not clear	
										1	Clears WSS_CHNGD_Q bit	
		Reserved.				x					Not used	
	Reserved.			x						Not used		
	Reserved.		x							Not used		
MPU_STIM_INTRQ_CLR.		0								Do not clear		
		1								Clears MPU_STIM_INTRQ_Q bit		

# ADV7181B

Subaddress	Register	Bit Description	Bit								Comments	Notes	
			7	6	5	4	3	2	1	0			
0x48	Interrupt Mask 2	CCAPD_MSKB.									0	Masks CCAPD_Q bit	
												1	
	Read/Write	GEMD_MSKB.									0	Masks GEMD_Q bit	
												1	
	Register Access Page 2	CGMS_CHNGD_MSKB.									0	Masks CGMS_CHNGD_Q bit	
												1	
	Register Access Page 2	WSS_CHNGD_MSKB.									0	Masks WSS_CHNGD_Q bit	
												1	
		Reserved.					0					Not used	
	Reserved.				0						Not used		
	Reserved.			0							Not used		
	MPU_STIM_INTRQ_MSKB.	0									Masks MPU_STIM_INTRQ_Q bit		
											Unmasks MPU_STIM_INTRQ_Q bit		
0x49	Raw Status 3	SD_OP_50Hz. SD 60/50Hz frame rate at output.									0	SD 60 Hz signal output	These bits <b>cannot</b> be cleared or masked. Register 0x4A is used for this purpose.
												1	
	Read Only Register	SD_V_LOCK.									0	SD vertical sync lock not established	
												1	
	Register Access Page 2	SD_H_LOCK.									0	SD horizontal sync lock not established	
												1	
		Reserved.								x		Not used	
		SCM_LOCK. SECAM Lock.					0					SECAM lock not established	
							1					SECAM lock established	
		Reserved.				x						Not used	
	Reserved.			x							Not used		
	Reserved.	x									Not used		
0x4A	Interrupt Status 3	SD_OP_CHNG_Q. SD 60/50 Hz frame rate at input.									0	No change in SD signal standard detected at the input	These bits can be cleared and masked by Registers 0x4B and 0x4C, respectively.
												1	
	Read Only Register	SD_V_LOCK_CHNG_Q.									0	No change in SD vertical sync lock status	
												1	
	Register Access Page 2	SD_H_LOCK_CHNG_Q.									0	No change in SD horizontal sync lock status	
												1	
		SD_AD_CHNG_Q. SD autodetect changed.								x		No change in AD_RESULT[2:0] bits in Status Register 1	
												AD_RESULT[2:0] bits in Status Register 1 have changed	
		SCM_LOCK_CHNG_Q. SECAM Lock.					0					No change in SECAM lock status	
							1					SECAM lock status has changed	
		PAL_SW_LK_CHNG_Q.				x						No change in PAL swinging burst lock status	
											PAL swinging burst lock status has changed		
	Reserved.			x							Not used		
	Reserved.	x									Not used		

Subaddress	Register	Bit Description	Bit								Comments	Notes	
			7	6	5	4	3	2	1	0			
0x4B	Interrupt Clear 3	SD_OP_CHNG_CLR.									0	Do not clear	
												1	Clears SD_OP_CHNG_Q bit
	Write Only Register	SD_V_LOCK_CHNG_CLR.									0	Do not clear	
											1	Clears SD_V_LOCK_CHNG_Q bit	
	Register Access Page 2	SD_H_LOCK_CHNG_CLR.							0			Do not clear	
									1			Clears SD_H_LOCK_CHNG_Q bit	
		SD_AD_CHNG_CLR.					0					Do not clear	
							1					Clears SD_AD_CHNG_Q bit	
		SCM_LOCK_CHNG_CLR.				0						Do not clear	
						1						Clears SCM_LOCK_CHNG_Q bit	
	PAL_SW_LK_CHNG_CLR.			0							Do not clear		
				1							Clears PAL_SW_LK_CHNG_Q bit		
	Reserved.		x								Not used		
	Reserved.	x									Not used		
0x4C	Interrupt Mask 2	SD_OP_CHNG_MSKB.									0	Masks SD_OP_CHNG_Q bit	
											1	Unmasks SD_OP_CHNG_Q bit	
	Read / Write Register	SD_V_LOCK_CHNG_MSKB.									0	Masks SD_V_LOCK_CHNG_Q bit	
											1	Unmasks SD_V_LOCK_CHNG_Q bit	
	Register Access Page 2	SD_H_LOCK_CHNG_MSKB.							0			Masks SD_H_LOCK_CHNG_Q bit	
									1			Unmasks SD_H_LOCK_CHNG_Q bit	
		SD_AD_CHNG_MSKB.					0					Masks SD_AD_CHNG_Q bit	
							1					Unmasks SD_AD_CHNG_Q bit	
		SCM_LOCK_CHNG_MSKB.				0						Masks SCM_LOCK_CHNG_Q bit	
						1						Unmasks SCM_LOCK_CHNG_Q bit	
	PAL_SW_LK_CHNG_MSKB.			0							Masks PAL_SW_LK_CHNG_Q bit		
				1							Unmasks PAL_SW_LK_CHNG_Q bit		
	Reserved.		x								Not used		
	Reserved.	x									Not used		

# ADV7181B

Table 85. Common and Normal (Page 1) Register Map Details

Subaddress	Register	Bit Description	Bits								Comments	Notes		
			7	6	5	4	3	2	1	0				
0x00	Input Control	INSEL[3:0]. The INSEL bits allow the user to select an input channel as well as the input format.					0	0	0	0	Composite			
							0	0	0	1	Reserved			
							0	0	1	0	Reserved			
							0	0	1	1	Reserved			
							0	1	0	0	Reserved			
							0	1	0	1	Reserved			
							0	1	1	0	S-Video			
							0	1	1	1	Reserved			
							1	0	0	0	Reserved			
							1	0	0	1	YPrPb			
							1	0	1	0	Reserved			
							1	0	1	1	Reserved			
							1	1	0	0	Reserved			
							1	1	0	1	Reserved			
							1	1	1	0	Reserved			
							1	1	1	1	Reserved			
					VID_SEL[3:0]. The VID_SEL bits allow the user to select the input video standard.	0	0	0	0				Autodetect PAL (B/G/H/I/D), NTSC (without pedestal), SECAM	
						0	0	0	1				Autodetect PAL (B/G/H/I/D), NTSC-M (with pedestal), SECAM	
				0	0	1	0				Autodetect PAL (N), NTSC (M) (without pedestal), SECAM			
				0	0	1	1				Autodetect PAL (N), NTSC (M) (with pedestal), SECAM			
			0	1	0	0				NTSC-J				
			0	1	0	1				NTSC-M				
			0	1	1	0				PAL60				
			0	1	1	1				NTSC-4.43				
			1	0	0	0				PAL-B/G/H/I/D				
			1	0	0	1				PAL-N (B/G/H/I/D without pedestal)				
			1	0	1	0				PAL-M (without pedestal)				
			1	0	1	1				PAL-M				
			1	1	0	0				PAL-combination N				
			1	1	0	1				PAL-combination N				
			1	1	1	0				SECAM (with pedestal)				
			1	1	1	1				SECAM (with pedestal)				
0x01	Video Selection	Reserved.						0	0	0	Set to default			
		ENVSPROC.					0				Disable Vsync processor			
							1				Enable Vsync processor			
		Reserved.				0					Set to default			
		BETACAM.			0						Standard video input			
					1						Betacam input enable			
		ENHSPL.		0							Disable Hsync processor			
				1							Enable Hsync processor			
	Reserved.		1							Set to default				



Subaddress	Register	Bit Description	Bits							Comments	Notes		
			7	6	5	4	3	2	1			0	
0x03	Output Control	SD_DUP_AV. Duplicates the AV codes from the Luma into the chroma path.								0	AV codes to suit 8-bit interleaved data output		
											1	AV codes duplicated (for 16-bit interfaces)	
		Reserved.								0	Set as default		
		OF_SEL[3:0]. Allows the user to choose from a set of output formats.			0	0	0	0			Reserved		
					0	0	0	1			Reserved		
					0	0	1	0			16-bit @ LLC1 4:2:2		
					0	0	1	1			8-bit @ LLC1 4:2:2 ITU-R BT.656		
					0	1	0	0			Not used		
					0	1	0	1			Not used		
					0	1	1	0			Not used		
					0	1	1	1			Not used		
					1	0	0	0			Not used		
					1	0	0	1			Not used		
					1	0	1	0			Not used		
					1	0	1	1			Not used		
		TOD. Three-state output drivers. This bit allows the user to three-state the output drivers: P[19:0], HS, VS, FIELD, and SFL.		0							Output pins enabled	See TIM_OE, Address 0x04[3] and TRI_LLC, Address 0x1D[7]	
				1							Drivers three-stated		
			VBI_EN. Allows VBI data (Lines 1 to 21) to be passed through with only a minimum amount of filtering performed.	0								All lines filtered and scaled	
				1								Only active video region filtered	
		0x04	Extended Output Control	RANGE. Allows the user to select the range of output values. Can be BT656-compliant, or can fill the whole accessible number range.							0	16 < Y < 235, 16 < C < 240	ITU-R BT.656.
										1	1 < Y < 254, 1 < C < 254	Extended range.	
EN_SFL_PIN.										0	SFL output is disabled	SFL output enables encoder and decoder to be connected directly.	
										1	SFL information output on the SFL pin		
BL_C_VBI. Blank chroma during VBI. If set, enables data in the VBI region to be passed through the decoder undistorted.										0	Decode and output color	During VBI.	
										1	Blank Cr and Cb		
TIM_OE. Timing signals output enable.							0				HS, VS, F three-stated	Controlled by TOD.	
							1				HS, VS, F forced active		
Reserved.					x	x							
Reserved.				1									
BT656-4. Allows the user to select an output mode compatible with ITU-R BT656-3/4.	0								BT656-3-compatible				
	1								BT656-4-compatible				

# ADV7181B

Subaddress	Register	Bit Description	Bits							Comments	Notes	
			7	6	5	4	3	2	1			0
0x07	Autodetect Enable	AD_PAL_EN. PAL B/G/I/H autodetect enable.								0	Disable	
										1	Enable	
		AD_NTSC_EN. NTSC autodetect enable.								0	Disable	
										1	Enable	
		AD_PALM_EN. PAL M autodetect enable.								0	Disable	
										1	Enable	
		AD_PALN_EN. PAL N autodetect enable.								0	Disable	
										1	Enable	
		AD_P60_EN. PAL60 autodetect enable.								0	Disable	
										1	Enable	
0x07	Autodetect Enable	AD_N443_EN. NTSC443 autodetect enable.								0	Disable	
										1	Enable	
		AD_SECAM_EN. SECAM autodetect enable.								0	Disable	
										1	Enable	
0x07	Autodetect Enable	AD_SEC525_EN. SECAM 525 autodetect enable.								0	Disable	
										1	Enable	
0x08	Contrast Register	CON[7:0]. Contrast adjust. This is the user control for contrast adjustment.	1	0	0	0	0	0	0	0	Luma gain = 1	0x00 Gain = 0; 0x80 Gain = 1; 0xFF Gain = 2.
0x09	Reserved	Reserved.	1	0	0	0	0	0	0	0		
0x0A	Brightness Register	BRI[7:0]. This register controls the brightness of the video signal.	0	0	0	0	0	0	0	0		0x00 = 0IRE; 0x7F = +100IRE; 0x80 = -100IRE.
0x0B	Hue Register	HUE[7:0]. This register contains the value for the color hue adjustment.	0	0	0	0	0	0	0	0		Hue range = -90° to +90°.
0x0C	Default Value Y	DEF_VAL_EN. Default value enable.								0	Free-run mode dependent on DEF_VAL_AUTO_EN	
										1	Force free-run mode on and output blue screen	
		DEF_VAL_AUTO_EN. Default value.								0	Disable free-run mode	When lock is lost, free-run mode can be enabled to output stable timing, clock, and a set color.
										1	Enable automatic free-run mode (blue screen)	
0x0C	Default Value Y	DEF_Y[5:0]. Default value Y. This register holds the Y default value.	0	0	1	1	0	1			Y[7:0] = {DEF_Y[5:0], 0, 0}	Default Y value output in free-run mode.
0x0D	Default Value C	DEF_C[7:0]. Default value C. The Cr and Cb default values are defined in this register.	0	1	1	1	1	1	0	0	Cr[7:0] = DEF_C[7:4], 0, 0, 0, 0; Cb[7:0] = DEF_C[3:0], 0, 0, 0, 0	Default Cb/Cr value output in free-run mode. Default values give blue screen output.
0x0E	ADI Control	Reserved.					0	0	0	0	Set as default	
		SUB_USR_EN. Enables the user to access the Interrupt map.					0				Access user reg map	See Figure 37.
											Access interrupt reg map	
0x0E	ADI Control	Reserved.	0	0						Set as default		

Subaddress	Register	Bit Description	Bits							Comments	Notes		
			7	6	5	4	3	2	1			0	
0x0F	Power Management	Reserved.							0	0	Set to default		
		PDBP. Power-down bit priority selects between PWRDN bit and PIN.						0			Chip power-down controlled by pin		
								1			Bit has priority (pin disregarded)		
		Reserved.				0	0				Set to default		
		PWRDN. Power-down places the decoder in a full power-down mode.			0						System functional		
					1						Powered down	See PDBP, 0x0F Bit 2.	
Reserved.		0							Set to default				
RES. Chip reset loads all I <sup>2</sup> C bits with default values.		0							Normal operation				
		1							Start reset sequence	Executing reset takes approximately 2 ms. This bit is self-clearing.			
0x10	Status Register 1. (Read Only)	IN_LOCK.							x		In lock (right now) = 1	Provides information about the internal status of the decoder.	
		LOST_LOCK.							x		Lost lock (since last read) = 1		
		FSC_LOCK.						x			F <sub>sc</sub> lock (right now) = 1		
		FOLLOW_PW.					x				Peak white AGC mode active = 1		
		AD_RESULT[2:0]. Autodetection result reports the standard of the input video.		0	0	0						NTSM-MJ	Detected standard.
				0	0	1						NTSC-443	
				0	1	0						PAL-M	
				0	1	1						PAL-60	
				1	0	0						PAL-B/G/H/I/D	
				1	0	1						SECAM	
	1		1	0						PAL-combination N			
COL_KILL.	x								Color kill is active = 1	Color kill.			
0x11	IDENT (Read Only)	IDENT[7:0] Provides identification on the revision of the part.	x	x	x	x	x	x	x	x		ADV7181B = 0x13.	
0x12	Status Register 2 (Read Only)	MVCS DET.								x	MV color striping detected	1 = detected.	
		MVCS T3.								x		MV color striping type	0 = Type 2, 1 = Type 3.
		MV PS DET.							x			MV pseudo sync detected	1 = detected.
		MV AGC DET.						x				MV AGC pulses detected	1 = detected.
		LL NSTD.					x					Nonstandard line length	1 = detected.
		FSC NSTD.				x						F <sub>sc</sub> frequency nonstandard	1 = detected.
		Reserved.	x	x									
0x13	Status Register 3 (Read Only)	INST_HLOCK.								x	1 = horizontal lock achieved	Unfiltered.	
		GEMD.								x		1 = Gemstar data detected	
		SD_OP_50HZ.							x			SD 60 Hz detected	SD field rate detect.
		Reserved.						x				SD 50 Hz detected	
		FREE_RUN_ACT.					x					1 = Free-run mode active	Blue screen output.
		STD_FLD_LEN.				x						1 = Field length standard	Correct field length found.
		INTERLACED.		x								1 = Interlaced video detected	Field sequence found.
		PAL_SW_LOCK.	x									1 = Swinging burst detected	Reliable swinging burst sequence.

# ADV7181B

Subaddress	Register	Bit Description	Bits						Comments	Notes		
			7	6	5	4	3	2			1	0
0x14	Analog Clamp Control	Reserved.					0	0	1	0	Set to default	
		CCLEN. Current clamp enable allows the user to switch off the current sources in the analog front.				0					Current sources switched off	
						1					Current sources enabled	
		Reserved.	0	0	0						Set to default	
0x15	Digital Clamp Control 1	Reserved.				0	x	x	x	x	Set to default	
		DCT[1:0]. Digital clamp timing determines the time constant of the digital fine clamp circuitry.	0	0							Slow (TC = 1 sec)	
			0	1							Medium (TC = 0.5 sec)	
			1	0							Fast (TC = 0.1 sec)	
			1	1							TC dependent on video	
	Reserved.	0								Set to default		
0x17	Shaping Filter Control	YSFM[4:0]. Selects Y Shaping Filter mode when in CVBS only mode.				0	0	0	0	0	Auto wide notch for poor quality sources or wideband filter with comb for good quality input	Decoder selects optimum Y shaping filter depending on CVBS quality.
		Allows the user to select a wide range of low-pass and notch filters.				0	0	0	0	1	Auto narrow notch for poor quality sources or wideband filter with comb for good quality input	
		If either auto mode is selected, the decoder selects the optimum Y filter depending on the CVBS video source quality (good vs. bad).				0	0	0	1	0	SVHS 1	
						0	0	0	1	1	SVHS 2	
						0	0	1	0	0	SVHS 3	
						0	0	1	0	1	SVHS 4	
						0	0	1	1	0	SVHS 5	
						0	0	1	1	1	SVHS 6	
						0	1	0	0	0	SVHS 7	
						0	1	0	0	1	SVHS 8	
						0	1	0	1	0	SVHS 9	
						0	1	0	1	1	SVHS 10	
						0	1	1	0	0	SVHS 11	
						0	1	1	0	1	SVHS 12	
						0	1	1	1	0	SVHS 13	
						0	1	1	1	1	SVHS 14	
						1	0	0	0	0	SVHS 15	
						1	0	0	0	1	SVHS 16	
						1	0	0	1	0	SVHS 17	
						1	0	0	1	1	SVHS 18 (CCIR601)	
						1	0	1	0	0	PAL NN1	
						1	0	1	0	1	PAL NN2	
						1	0	1	1	0	PAL NN3	
						1	0	1	1	1	PAL WN 1	
						1	1	0	0	0	PAL WN 2	
						1	1	0	0	1	NTSC NN1	
						1	1	0	1	0	NTSC NN2	
						1	1	0	1	1	NTSC NN3	
						1	1	1	0	0	NTSC WN1	
						1	1	1	0	1	NTSC WN2	
						1	1	1	1	0	NTSC WN3	
						1	1	1	1	1	Reserved	
		CSFM[2:0]. C shaping filter mode allows the selection from a range of low-pass chrominance filters, SH1 to SH5 and wideband mode.	0	0	0					Auto selection 15 MHz	Automatically selects a C filter for the specified 3 dB cutoff.	
		0	0	1					Auto selection 2.17 MHz			
		0	1	0					SH1			
		0	1	1					SH2			
		1	0	0					SH3			
		1	0	1					SH4			
		1	1	0					SH5			
		1	1	1					Wideband mode			

Subaddress	Register	Bit Description	Bits							Comments	Notes	
			7	6	5	4	3	2	1			0
0x18	Shaping Filter Control 2	WYSFM[4:0]. Wideband Y shaping filter mode allows the user to select which Y shaping filter is used for the Y component of Y/C, YPbPr, B/W input signals; it is also used when a good quality input CVBS signal is detected. For all other inputs, the Y shaping filter chosen is controlled by WYSFM[4:0].				0	0	0	0	0	Reserved; do not use	
						0	0	0	0	1	Reserved; do not use	
						0	0	0	1	0	SVHS 1	
						0	0	0	1	1	SVHS 2	
						0	0	1	0	0	SVHS 3	
						0	0	1	0	1	SVHS 4	
						0	0	1	1	0	SVHS 5	
						0	0	1	1	1	SVHS 6	
						0	1	0	0	0	SVHS 7	
						0	1	0	0	1	SVHS 8	
						0	1	0	1	0	SVHS 9	
						0	1	0	1	1	SVHS 10	
						0	1	1	0	0	SVHS 11	
						0	1	1	0	1	SVHS 12	
						0	1	1	1	0	SVHS 13	
						0	1	1	1	1	SVHS 14	
						1	0	0	0	0	SVHS 15	
						1	0	0	0	1	SVHS 16	
						1	0	0	1	0	SVHS 17	
						1	0	0	1	1	SVHS 18 (CCIR 601)	
			1	0	1	0	0	Reserved; do not use				
			~	~	~	~	~	Reserved; do not use				
			1	1	1	1	1	Reserved; do not use				
		Reserved.		0	0				Set to default			
		WYSFMOVR. Enables the use of automatic WYSFN filter.	0						Autoselection of best filter			
			1						Manual select filter using WYSFM[4:0]			
0x19	Comb Filter Control	PSFSEL[1:0]. Controls the signal bandwidth that is fed to the comb filters (PAL).						0	0	Narrow		
								0	1	Medium		
								1	0	Wide		
								1	1	Widest		
		NSFSEL[1:0]. Controls the signal bandwidth that is fed to the comb filters (NTSC).				0	0			Narrow		
							0	1		Medium		
							1	0		Medium		
							1	1		Wide		
		Reserved.	1	1	1	1			Set as default			
0x1D	ADI Control 2	Reserved.				0	0	x	x	x	Set to default	
		VS_JIT_COMP_EN.			0						Enabled	
					1						Disabled	
		EN28XTAL.		0							Use 27 MHz crystal	
				1							Use 28 MHz crystal	
		TRI_LLC.	0								LLC pin active	
		1							LLC pin three-stated			

# ADV7181B

Subaddress	Register	Bit Description	Bits								Comments	Notes		
			7	6	5	4	3	2	1	0				
0x27	Pixel Delay Control	LTA[1:0]. Luma timing adjust allows the user to specify a timing difference between chroma and luma samples.							0	0	No delay	CVBS mode LTA[1:0] = 00b; S-Video mode LTA[1:0] = 01b, YPrPb mode LTA[1:0] = 01b.		
									1	0	Luma 1 clk (37 ns) delayed			
									1	0	Luma 2 clk (74 ns) early			
									1	1	Luma 1 clk (37 ns) early			
		Reserved.								0		Set to 0		
		CTA[2:0]. Chroma timing adjust allows a specified timing difference between the luma and chroma samples.				0	0	0				Not valid setting	CVBS mode CTA[2:0] = 011b.	
						0	0	1				Chroma +2 pixels (early)		
						0	1	0				Chroma +1 pixel (early)	S-Video mode CTA[2:0] = 101b.	
						0	1	1				No delay		
						1	0	0				Chroma -1 pixel (late)		
						1	0	1				Chroma -2 pixels (late)	YPrPb mode CTA[2:0] = 110b.	
						1	1	0				Chroma -3 pixels (late)		
				1	1	1				Not valid setting				
		AUTO_PDC_EN. Automatically programs the LTA/CTA values so that luma and chroma are aligned at the output for all modes of operation.		0								Use values in LTA[1:0] and CTA[2:0] for delaying luma/chroma		
				1								LTA and CTA values determined automatically		
SWPC. Allows the Cr and Cb samples to be swapped.		0								No swapping	See Swap_CR_CB_WB, Addr 0x89.			
		1								Swap the Cr and Cb O/P samples				
0x2B	Misc Gain Control	PW_UPD. Peak white update determines the rate of gain.							0	Update once per video line	Peak white must be enabled. See LAGC[2:0].			
									1	Update once per field				
		Reserved.				1	0	0	0	0	Set to default			
		CKE. Color kill enable allows the color kill function to be switched on and off.		0							Color kill disabled	For SECAM color kill, threshold is set at 8%. See CKILLTHR[2:0].		
				1							Color kill enabled			
		Reserved.		1							Set to default			
0x2C	AGC Mode Control	CAGC[1:0]. Chroma automatic gain control selects the basic mode of operation for the AGC in the chroma path.							0	0	Manual fixed gain	Use CMG[11:0].		
										0	1		Use luma gain for chroma	
											1	0	Automatic gain	Based on color burst.
											1	1	Freeze chroma gain	
		Reserved.						1	1			Set to 1		
		LAGC[2:0]. Luma automatic gain control selects the mode of operation for the gain control in the luma path.		0	0	0					Manual fixed gain	Use LMG[11:0].		
				0	0	1					Peak white algorithm off		Blank level to sync tip.	
				0	1	0					Peak white algorithm onl	Blank level to sync tip.		
				0	1	1					AGC no override through peak white; automatic IRE control		Blank level to sync tip.	
				1	0	0					AGC auto-override through peak white; automatic IRE control	Blank level to sync tip.		
				1	0	1					AGC active video with peak white			
				1	1	0					AGC active video with average video			
				1	1	1					Freeze gain			
		Reserved.		1							Set to 1			

Subaddress	Register	Bit Description	Bits							Comments	Notes		
			7	6	5	4	3	2	1			0	
0x2D	Chroma Gain Control 1	CMG[11:8]. Chroma manual gain can be used to program a desired manual chroma gain. Reading back from this register in AGC mode gives the current gain.					0	1	0	0		CAGC[1:0] settings decide in which mode CMG[11:0] operates.	
		Reserved.			1	1					Set to 1		
		CAGT[1:0]. Chroma automatic gain timing allows adjustment of the chroma AGC tracking speed.	0	0								Slow (TC = 2 sec)	Has an effect only if CAGC[1:0] is set to auto gain (10).
			0	1								Medium (TC = 1 sec)	
1	0									Fast (TC = 0.2 sec)			
1	1									Adaptive			
0x2E	Chroma Gain Control 2	CMG[7:0]. Chroma manual gain lower 8 bits. See CMG[11:8] for description.	0	0	0	0	0	0	0	0	CMG[11:0] = 750d; gain is 1 in NTSC CMG[11:0] = 741d; gain is 1 in PAL	Min value is 0 d (G = -60 dB) Max value is 3750 (Gain = 5).	
0x2F	Luma Gain Control 1	LMG[11:8]. Luma manual gain can be used to program a desired manual chroma gain, or to read back the actual gain value used.					x	x	x	x	LAGC[1:0] settings decide in which mode LMG[11:0] operates		
		Reserved.			1	1					Set to 1		
		LAGT[1:0]. Luma automatic gain timing allows adjustment of the luma AGC tracking speed.	0	0								Slow (TC = 2 sec)	Has an effect only if LAGC[1:0] is set to auto gain (001, 010, 011, or 100).
			0	1								Medium (TC = 1 sec)	
1	0									Fast (TC = 0.2 sec)			
1	1									Adaptive			
0x30	Luma Gain Control 2	LMG[7:0]. Luma manual gain can be used to program a desired manual chroma gain or read back the actual used gain value.	x	x	x	x	x	x	x	x	LMG[11:0] = 1234d; gain is 1 in NTSC LMG[11:0] = 1266d; gain is 1 in PAL	Min value NTSC 1024 (G = 0.85), PAL (G = 0.81). Max value NTSC 2468 (G = 2), PAL = 2532 (G = 2).	
0x31	VS and FIELD Control 1	Reserved.						0	1	0	Set to default		
		HVSTIM. Selects where the VS signal is asserted within a line of video.					0				Start of line relative to HSE	HSE = Hsync end.	
							1				Start of line relative to HSB	HSB = Hsync begin.	
		NEWAVMODE. Sets the EAV/SAV mode.				0						EAV/SAV codes generated to suit ADI encoders	
						1						Manual VS/field position controlled by registers 0x32, 0x33, and 0xE5-0xEA	
Reserved.	0	0	0							Set to default			
0x32	Vsync Field Control 2	Reserved.			0	0	0	0	0	0	1	Set to default	NEWAVMODE bit must be set high.
		VSBHE.	0									VS goes high in the middle of the line (even field)	
			1									VS changes state at the start of the line (even field)	
		VSBHO.	0									VS goes high in the middle of the line (odd field)	
1										VS changes state at the start of the line (odd field)			
0x33	Vsync Field Control 3	Reserved.			0	0	0	1	0	0	Set to default	NEWAVMODE bit must be set high.	
		VSEHE.	0								VS goes low in the middle of the line (even field)		
			1								VS changes state at the start of the line (even field)		
		VSEHO.	0								VS goes low in the middle of the line (odd field)		
1									VS changes state at the start of the line (odd field)				

# ADV7181B

Subaddress	Register	Bit Description	Bits							Comments	Notes		
			7	6	5	4	3	2	1			0	
0x34	HS Position Control 1	HSE[10:8]. HS end allows the positioning of the HS output within the video line.						0	0	0	HS output ends HSE[10:0] pixels after the falling edge of Hsync	Using HSB and HSE, the user can program the position and length of the output Hsync.	
		Reserved.				0					Set to 0		
		HSB[10:8]. HS begin allows the positioning of the HS output within the video line.		0	0	0							HS output starts HSB[10:0] pixels after the falling edge of Hsync
		Reserved.	0										Set to 0
0x35	HS Position Control 2	HSB[7:0] Using HSB[10:0] and HSE[10:0], the user can program the position and length of HS output signal.	0	0	0	0	0	0	1	0			
0x36	HS Position Control 3	HSE[7:0] See Notes, above.	0	0	0	0	0	0	0	0			
0x37	Polarity	PCLK. Sets the polarity of LLC1.								0	Invert polarity		
									1	Normal polarity as per the timing diagrams			
		Reserved.					0	0			Set to 0		
		PF. Sets the FIELD polarity.				0					Active high		
					1						Active low		
		Reserved.			0						Set to 0		
		PVS. Sets the VS Polarity.			0						Active high		
				1							Active low		
0x38	NTSC Comb Control	YCMN[2:0]. Luma comb mode, NTSC.						0	0	0	Adaptive 3-line, 3-tap luma		
								1	0	0	Use low-pass notch		
								1	0	1	Fixed luma comb (2-line)	Top lines of memory.	
								1	1	0	Fixed luma comb (3-Line)	All lines of memory.	
		CCMN[2:0]. Chroma comb mode, NTSC.				0	0	0				3-line adaptive for CTAPSN = 01 4-line adaptive for CTAPSN = 10 5-line adaptive for CTAPSN = 11	
					1	0	0					Disable chroma comb	
					1	0	1					Fixed 2-line for CTAPSN = 01 Fixed 3-line for CTAPSN = 10 Fixed 4-line for CTAPSN = 11	Top lines of memory.
					1	1	0					Fixed 3-line for CTAPSN = 01 Fixed 4-line for CTAPSN = 10 Fixed 5-line for CTAPSN = 11	All lines of memory.
					1	1	1					Fixed 2-line for CTAPSN = 01 Fixed 3-line for CTAPSN = 10 Fixed 4-line for CTAPSN = 11	Bottom lines of memory.
					0	0							Adapts 3 lines – 2 lines
		CTAPSN[1:0]. Chroma comb taps, NTSC.		0	1							Not used	
				1	0							Adapts 5 lines – 3 lines	
				1	1							Adapts 5 lines – 4 lines	
				1	1								



Subaddress	Register	Bit Description	Bits							Comments	Notes		
			7	6	5	4	3	2	1			0	
0x39	PAL Comb Control	YCMP[2:0]. Luma comb mode, PAL.						0	0	0	Adaptive 5-line, 3-tap luma comb		
								1	0	0	Use low-pass notch		
								1	1	0	Fixed luma comb	Top lines of memory.	
								1	1	0	Fixed luma comb (5-line)	All lines of memory.	
								1	1	1	Fixed luma comb (3-line)	Bottom lines of memory.	
		CCMP[2:0]. Chroma comb mode, PAL.			0	0	0					3-line adaptive for CTAPSN = 01 4-line adaptive for CTAPSN = 10 5-line adaptive for CTAPSN = 11	
					1	0	0					Disable chroma comb	
					1	0	1					Fixed 2-line for CTAPSN = 01	Top lines of memory.
												Fixed 3-line for CTAPSN = 10	
												Fixed 4-line for CTAPSN = 11	
					1	1	0					Fixed 3-line for CTAPSN = 01	All lines of memory.
												Fixed 4-line for CTAPSN = 10	
												Fixed 5-line for CTAPSN = 11	
					1	1	1					Fixed 2-line for CTAPSN = 01	Bottom lines of memory.
											Fixed 3-line for CTAPSN = 10		
											Fixed 4-line for CTAPSN = 11		
		CTAPSP[1:0]. Chroma comb taps, PAL.		0	0							Not used	
				0	1							Adapts 5-lines – 3 lines (2 taps)	
				1	0							Adapts 5 lines – 3 lines (3 taps)	
	1		1							Adapts 5 lines – 4 lines (4 taps)			
0x3A		Reserved.							0	Set as default			
		PWRDN_ADC_2. Enables power-down of ADC2.							0	ADC2 normal operation			
									1	Power down ADC2			
		PWRDN_ADC_1. Enables power-down of ADC1.							0	ADC1 normal operation			
									1	Power down ADC1			
		PWRDN_ADC_0. Enables power-down of ADC0.							0	ADC0 normal operation			
							1	Power down ADC0					
0x3D	Manual Window Control	Reserved.	0	0	0	1				Set as default			
		CKILLTHR[2:0].	0	0	0						Kill at 0.5%	CKE = 1 enables the color kill function and must be enabled for CKILLTHR[2:0] to take effect.	
	0	0	1						Kill at 1.5%				
	0	1	0						Kill at 2.5%				
	0	1	1						Kill at 4%				
	1	0	0						Kill at 8.5%				
	1	0	1						Kill at 16%				
	1	1	0						Kill at 32%				
	1	1	1						Reserved				
	Reserved.	0							Set to default				

# ADV7181B

Subaddress	Register	Bit Description	Bits							Comments	Notes	
			7	6	5	4	3	2	1			0
0x41	Resample Control	Reserved.			0	1	0	0	0	0	Set to default	
		SFL_INV. Controls the behavior of the PAL switch bit.		0							SFL compatible with ADV7190/ADV7191/ADV7194 encoders	
				1							SFL compatible with ADV717x/ADV7173x encoders	
		Reserved.	0								Set to default	
0x48	Gemstar Control 1	GDECEL[15:8]. See the Comments column.	0	0	0	0	0	0	0	0	GDECEL[15:0]; 16 individual enable bits that select the lines of video (even field Lines 10 to 25) that the decoder checks for Gemstar-compatible data	LSB = Line 10; MSB = Line 25. Default = Do not check for Gemstar-compatible data on any lines[10 to 25] in even fields.
0x49	Gemstar Control 2	GDECEL[7:0]. See the Comments column.	0	0	0	0	0	0	0	0		
0x4A	Gemstar Control 3	GDECOL[15:8]. See the Comments column.	0	0	0	0	0	0	0	0	GDECOL[15:0]; 16 individual enable bits that select the lines of video (odd field Lines 10 to 25) that the decoder checks for Gemstar-compatible data	LSB = Line 10; MSB = Line 25. Default = Do not check for Gemstar-compatible data on any lines[10 to 25] in odd fields.
0x4B	Gemstar Control 4	GDECOL[7:0]. See the Comments column.	0	0	0	0	0	0	0	0		
0x4C	Gemstar Control 5	GDECAD. Controls the manner in which decoded Gemstar data is inserted into the horizontal blanking period.								0	Split data into half byte	To avoid 00/FF code.
										1	Output in straight 8-bit format	
		Reserved.	x	x	x	x	x	x	x	x	Undefined	
0x4D	CTI DNR Control 1	CTI_EN. CTI enable.								0	Disable CTI	
										1	Enable CTI	
		CTI_AB_EN. Enables the mixing of the transient improved chroma with the original signal.								0	Disable CTI alpha blender	
										1	Enable CTI alpha blender	
		CTI_AB[1:0]. Controls the behavior of the alpha-blend circuitry.					0	0			Sharpest mixing	
							0	1			Sharp mixing	
							1	0			Smooth	
						1	1				Smoothest	
Reserved.				0					Set to default			
DNR_EN. Enable or bypass the DNR block.			0						Bypass the DNR block			
			1						Enable the DNR block			
Reserved.	1	1							Set to default			
0x4E	CTI DNR Control 2	CTI_CTH[7:0]. Specifies how big the amplitude step must be to be steepened by the CTI block.	0	0	0	0	1	0	0	0	Set to 0x04 for A/V input; set to 0x0A for tuner input	
0x50	CTI DNR Control 4	DNR_TH[7:0]. Specifies the maximum edge that is interpreted as noise and is therefore blanked.	0	0	0	0	1	0	0	0		

Subaddress	Register	Bit Description	Bits							Comments	Notes		
			7	6	5	4	3	2	1			0	
0x51	Lock Count	COL[2:0]. Count-into-lock determines the number of lines the system must remain in lock before showing a locked status.						0	0	0	1 line of video		
								0	0	1	2 lines of video		
								0	1	0	5 lines of video		
								0	1	1	10 lines of video		
								1	0	0	100 lines of video		
								1	0	1	500 lines of video		
								1	1	0	1000 lines of video		
							1	1	1	100000 lines of video			
				COL[2:0]. Count-out-of-lock determines the number of lines the system must remain out-of-lock before showing a lost-locked status.			0	0	0				1 line of video
							0	0	1				2 lines of video
							0	1	0				5 lines of video
							0	1	1				10 lines of video
							1	0	0				100 lines of video
							1	0	1				500 lines of video
					1	1	0			1000 lines of video			
				1	1	1			100000 lines of video				
		SRLS. Select raw lock signal. Selects the determination of the locked status.		0						Over field with vertical info			
				1						Line-to-line evaluation			
		FSCLE. Fsc lock enable.	0							Lock status set only by horizontal lock			
				1						Lock status set by horizontal lock and subcarrier lock			
0x8F	Free Run Line Length 1	Reserved.					0	0	0	0	Set to default		
		LLC_PAD_SEL[2:0]. Enables manual selection of clock for LLC1 pin.			0	0	0						LLC1 (nominal 27 MHz) selected out on LLC1 pin
					1	0	1						
		Reserved.	0										Set to default
0x90	VBI Info (Read Only)	WSSD. Screen signaling detected.								0	No WSS detected	Read only status bits.	
										1	WSS detected		
		CCAPD. Closed caption data.								0	No CCAP signals detected		
										1	CCAP sequence detected		
		EDTVD. EDTV sequence.							0		No EDTV sequence detected		
									1		EDTV sequence detected		
		CGMSD. CGMS sequence.						0			No CGMS transition detected		
						1			CGMS sequence decoded				
		Reserved.	x	x	x	x							
0x91	WSS1 (Read Only)	WSS1[7:0] Wide screen signaling data.	x	x	x	x	x	x	x	x			
0x92	WSS2 (Read Only)	WSS2[7:0] Wide screen signaling data.	x	x	x	x	x	x	x	x	WSS2[7:6] are undetermined		
0x93	EDTV1 (Read Only)	EDTV1[7:0] EDTV data register.	x	x	x	x	x	x	x	x			
0x94	EDTV2 (Read Only)	EDTV2[7:0] EDTV data register.	x	x	x	x	x	x	x	x			
0x95	EDTV3 (Read Only)	EDTV3[7:0] EDTV data register.	x	x	x	x	x	x	x	x	EDTV3[7:6] are undetermined	EDTV3[5] is reserved for future use.	
0x96	CGMS1 (Read Only)	CGMS1[7:0] CGMS data register.	x	x	x	x	x	x	x	x			
0x97	CGMS2 (Read Only)	CGMS2[7:0] CGMS data register.	x	x	x	x	x	x	x	x			
0x98	CGMS3 (Read Only)	CGMS3[7:0] CGMS data register.	x	x	x	x	x	x	x	x	CGMS3[7:4] are undetermined		

# ADV7181B

Subaddress	Register	Bit Description	Bits							Comments	Notes				
			7	6	5	4	3	2	1			0			
0x99	CCAP1 (Read Only)	CCAP1[7:0] Closed caption data register.	x	x	x	x	x	x	x	x	x	CCAP1[7] contains parity bit for byte 0			
0x9A	CCAP2 (Read Only)	CCAP2[7:0] Closed caption data register.	x	x	x	x	x	x	x	x	x	CCAP2[7] contains parity bit for byte 0			
0x9B	Letterbox 1 (Read Only)	LB_LCT[7:0] Letterbox data register.	x	x	x	x	x	x	x	x	x	Reports the number of black lines detected at the top of active video	This feature examines the active video at the start and at the end of each field. It enables format detection even if the video is not accompanied by a CGMS or WSS sequence.		
0x9C	Letterbox 2 (Read Only)	LB_LCM[7:0] Letterbox data register.	x	x	x	x	x	x	x	x	x	Reports the number of black lines detected in the bottom half of active video if subtitles are detected			
0x9D	Letterbox 3 (Read Only)	LB_LCB[7:0] Letterbox data register.	x	x	x	x	x	x	x	x	x	Reports the number of black lines detected at the bottom of active video.			
0xB2	CRC Enable Write Register	Reserved.								0	0	Set as default			
		CRC_ENABLE. Enable CRC checksum decoded from CGMS packet to validate CGMSD.								0			Turn off CRC check		
										1			CGMSD goes high with valid checksum		
		Reserved.	0	0	0	1	1						Set as default		
0xC3	ADC SWITCH 1	ADC0_SW[3:0]. Manual muxing control for ADC0.					0	0	0	0	No connection	SETADC_sw_man_en = 1.			
							0	0	0	1	AIN2				
							0	0	1	0	No connection				
							0	0	1	1	No connection				
							0	1	0	0	AIN4				
							0	1	0	1	AIN6				
							0	1	1	0	No connection				
							0	1	1	1	No connection				
							1	0	0	0	No connection				
							1	0	0	1	AIN1				
							1	0	1	0	No connection				
							1	0	1	1	No connection				
						1	1	0	0	AIN3					
						1	1	0	1	AIN5					
						1	1	1	0	No connection					
						1	1	1	1	No connection					
				ADC1_SW[3:0]. Manual muxing control for ADC1.	0	0	0	0					No connection	SETADC_sw_man_en = 1.	
					0	0	0	1							No connection
					0	0	1	0							No connection
					0	0	1	1							No connection
					0	1	0	0							AIN4
					0	1	0	1							AIN6
					0	1	1	0							No connection
					0	1	1	1							No connection
		1	0		0	0						No connection			
		1	0		0	1						No connection			
		1	0		1	0						No connection			
		1	0		1	1						No connection			
		1	1	0	0						AIN3				
		1	1	0	1						AIN5				
		1	1	1	0						No connection				
		1	1	1	1						No connection				

Subaddress	Register	Bit Description	Bits							Comments	Notes		
			7	6	5	4	3	2	1			0	
0xC4	ADC SWITCH 2	ADC_SW[3:0]. Manual muxing control for ADC2.					0	0	0	0	No connection	SETADC_sw_man_en = 1.	
							0	0	0	1	No connection		
							0	0	1	0	No connection		
							0	0	1	1	No connection		
							0	1	0	0	No connection		
							0	1	0	1	AIN6		
							0	1	1	0	No connection		
							0	1	1	1	No connection		
							1	0	0	0	No connection		
							1	0	0	1	No connection		
							1	0	1	0	No connection		
							1	0	1	1	No connection		
							1	1	0	0	No connection		
							1	1	0	1	AIN5		
				1	1	1	0	No connection					
				1	1	1	1	No connection					
		Reserved.		x	x	x							
		ADC_SW_MAN_EN. Enable manual setting of the input signal muxing.	0							Disable			
			1							Enable			
0xDC	Letterbox Control 1	LB_TH[4:0]. Sets the threshold value that determines if a line is black.				0	1	1	0	0	Default threshold for the detection of black lines		
		Reserved.	1	0	1						Set as default		
0xDD	Letterbox Control 2	LB_EL[3:0]. Programs the end line of the activity window for LB detection (end of field).					1	1	0	0	LB detection ends with the last line of active video on a field.;1100b: 262/525		
		LB_SL[3:0]. Program the start line of the activity window for LB detection (start of field).	0	1	0	0					Letterbox detection aligned with the start of active video; 0100b: 23/286 NTSC		
0xDE		Reserved.	0	0	0	0	0	0	0	0			
0xDF		Reserved.	0	0	0	0	0	0	0	0			
0xE0		Reserved.	0	0	0	1	0	1	0	0			
0xE1	SD Offset Cb	SD_OFF_CB[7:0]. Adjusts the hue by selecting the offset for the Cb channel.	1	0	0	0	0	0	0	0			
0xE2	SD Offset Cr	SD_OFF_CR[7:0]. Adjusts the hue by selecting the offset for the Cr channel.	1	0	0	0	0	0	0	0			
0xE3	SD Saturation Cb	SD_SAT_CB[7:0]. Adjusts the saturation of the picture by affecting gain on the Cb channel.	1	0	0	0	0	0	0	0	Chroma gain = 0 dB		
0xE4	SD Saturation Cr	SD_SAT_CR[7:0]. Adjusts the saturation of the picture by affecting gain on the Cr channel.	1	0	0	0	0	0	0	0	Chroma gain = 0 dB		
0xE5	NTSC V Bit Begin	NVBEG[4:0]. How many lines after lCOUNT rollover to set V high.				0	0	1	0	1	NTSC default (BT.656)		
		NVBEGSIGN.			0						Set to low when manual programming		
					1							Not suitable for user programming	
		NVBEGDELE. Delay V bit going high by one line relative to NVBEG (even field).	0								No delay		
			1									Additional delay by 1 line	
		NVBEGDELO. Delay V bit going high by one line relative to NVBEG (odd field).	0								No delay		
	1									Additional delay by 1 line			

# ADV7181B

Subaddress	Register	Bit Description	Bits							Comments	Notes		
			7	6	5	4	3	2	1			0	
0xE6	NTSC V Bit End	NVEND[4:0]. How many lines after I <sub>COUNT</sub> rollover to set V low.				0	0	1	0	0	NTSC default (BT.656)		
		NVENDSIGN.			0						Set to low when manual programming		
					1							Not suitable for user programming	
		NVENDDELE. Delay V bit going low by one line relative to NVEND (even field).		0								No delay	
				1								Additional delay by 1 line	
		NVENDDELO. Delay V bit going low by one line relative to NVEND (odd field).		0								No delay	
	1									Additional delay by 1 line			
0xE7	NTSC F Bit Toggle	NFTOG[4:0]. How many lines after I <sub>COUNT</sub> rollover to toggle F signal.				0	0	0	1	1	NTSC default		
		NFTOGSIGN.			0						Set to low when manual programming		
					1							Not suitable for user programming	
		NFTOGDELE. Delay F transition by one line relative to NFTOG (even field).		0								No delay	
				1								Additional delay by 1 line	
		NFTOGDELO. Delay F transition by one line relative to NFTOG (odd field).		0								No delay	
	1									Additional delay by 1 line			
0xE8	PAL V Bit Begin	PVBEG[4:0]. How many lines after I <sub>COUNT</sub> rollover to set V high.				0	0	1	0	1	PAL default (BT.656)		
		PVBEGSIGN.			0						Set to low when manual programming		
					1							Not suitable for user programming	
		PVBEGDELE. Delay V bit going high by one line relative to PVBEG (even field).		0								No delay	
				1								Additional delay by 1 line	
		PVBEGDELO. Delay V bit going high by one line relative to PVBEG (odd field).		0								No delay	
	1									Additional delay by 1 line			
0xE9	PAL V Bit End	PVEND[4:0]. How many lines after I <sub>COUNT</sub> rollover to set V low.				1	0	1	0	0	PAL default (BT.656)		
		PVENDSIGN.			0						Set to low when manual programming		
					1							Not suitable for user programming	
		PVENDDELE. Delay V bit going low by one line relative to PVEND (even field).		0								No delay	
				1								Additional delay by 1 line	
		PVENDDELO. Delay V bit going low by one line relative to PVEND (odd field).		0								No delay	
	1									Additional delay by 1 line			
0xEA	PAL F Bit Toggle	PFTOG[4:0]. How many lines after I <sub>COUNT</sub> rollover to toggle F signal.				0	0	0	1	1	PAL default (BT.656)		
		PFTOGSIGN.			0						Set to low when manual programming		
					1							Not suitable for user programming	
		PFTOGDELE. Delay F transition by one line relative to PFTOG (even field).		0								No delay	
				1								Additional delay by 1 line	
		PFTOGDELO. Delay F transition by one line relative to PFTOG (odd field).		0								No delay	
	1									Additional delay by 1 line			

Subaddress	Register	Bit Description	Bits							Comments	Notes	
			7	6	5	4	3	2	1			0
0xF4	Drive Strength	DR_STR_S[1:0]. Select the drive strength for the Sync output signals.							0	0	Low drive strength (1x)	
									0	1	Medium-low drive strength (2x)	
									1	0	Medium-high drive strength (3x)	
									1	1	High drive strength (4x)	
	DR_STR_C[1:0]. Select the drive strength for the Clock output signal.					0	0			Low drive strength (1x)		
						0	1			Medium-low drive strength (2x)		
						1	0			Medium-high drive strength (3x)		
						1	1			High drive strength (4x)		
	DR_STR[1:0]. Select the drive strength for the data output signals. Can be increased or decreased for EMC or crosstalk reasons.			0	0					Low drive strength (1x)		
				0	1					Medium-low drive strength (2x)		
				1	0					Medium-high drive strength (3x)		
				1	1					High drive strength (4x)		
Reserved.	x	x							No delay			
0xF8	IF Comp Control	IFFILTSEL[2:0]. IF filter selection for Pal and NTSC.					0	0	0	Bypass mode	0 dB.	
								0	0	1	<b>2 MHz</b> <b>5 MHz</b>	NTSC filters.
									0	1	0	-3 dB      -2 dB
									0	1	0	-6 dB      +3.5 dB
									0	1	1	-10 dB      +5 dB
								1	0	0	Reserved	
											<b>3 MHz</b> <b>6 MHz</b>	PAL filters.
								1	0	1	-2 dB      +2 dB	
								1	1	0	-5 dB      +3 dB	
								1	1	1	-7 dB      +5 dB	
Reserved.	0	0	0	0	0							
0xF9	VS Mode Control	EXTEND_VS_MAX_FREQ.							0	Limit maximum Vsync frequency to 66.25 Hz (475 lines/frame)		
										1		Limit maximum Vsync frequency to 70.09 Hz (449 lines/frame)
		EXTEND_VS_MIN_FREQ.								0		Limit minimum Vsync frequency to 42.75 Hz (731 lines/frame)
										1		Limit minimum Vsync frequency to 39.51 Hz (791 lines/frame)
		VS_COAST_MODE[1:0].					0	0				Auto coast mode
							0	1				50 Hz coast mode
							1	0				60 Hz coast mode
		Reserved.	0	0	0	0						Reserved
Reserved.	0	0	0	0								

## I<sup>2</sup>C PROGRAMMING EXAMPLES

### EXAMPLES FOR 28 MHz CLOCK

#### Mode 1 CVBS Input (Composite Video on AIN6)

All standards are supported through autodetect, 8-bit, 4:2:2, ITU-R BT.656 output on P15 to P8.

Table 86. Mode 1 CVBS Input

Register Address	Register Value	Notes
0x15	0x00	Slow down digital clamps.
0x17	0x41	Set CSFM to SH1.
0x1D	0x40	Enable 28 MHz crystal.
0x0F	0x40	TRAQ.
0x3A	0x16	Power down ADC 1 and ADC 2.
0x3D	0xC3	MWE enable manual window.
0x3F	0xE4	BGB to 36.
0x50	0x04	Set DNR threshold.
0xC3	0x05	Man mux AIN6 to ADC0 (0101).
0xC4	0x80	Enable manual muxing.
0x0E	0x80	ADI recommended programming sequence. This sequence must be followed exactly when setting up the decoder.
0x50	0x20	Recommended setting.
0x52	0x18	Recommended setting.
0x58	0xED	Recommended setting.
0x77	0xC5	Recommended setting.
0x7C	0x93	Recommended setting.
0x7D	0x00	Recommended setting.
0x90	0xC9	Recommended setting.
0x91	0x40	Recommended setting.
0x92	0x3C	Recommended setting.
0x93	0xCA	Recommended setting.
0x94	0xD5	Recommended setting.
0xCF	0x50	Recommended setting.
0xD0	0x4E	Recommended setting.
0xD6	0xDD	Recommended setting.
0xE5	0x51	Recommended setting.
0xD5	0xA0	Recommended setting.
0xD7	0xEA	Recommended setting.
0xE4	0x3E	Recommended setting.
0xEA	0x0F	Recommended setting.
0xE9	0x3E	Recommended setting.
0x0E	0x00	Recommended setting.



**Mode 2 S-Video Input (Y on AIN1 and C on AIN4)**

All standards are supported through autodetect, 8-bit, ITU-R BT.656 output on P15 to P8.

**Table 87. Mode 2 S-Video Input**

Register Address	Register Value	Notes
0x00	0x06	S-Video input.
0x15	0x00	Slow down digital clamps.
0x1D	0x40	Enable 28 MHz crystal.
0x0F	0x40	TRAQ.
0x3A	0x12	Power down ADC 2.
0x3D	0xC3	MWE enable manual window.
0x3F	0xE4	BGB to 36.
0x50	0x04	Set DNR threshold.
0xC3	0x41	Manual mux AIN2 to ADC0 (0001), AIN4 to ADC1 (0100).
0xC4	0x80	Enable manual muxing.
0x0E	0x80	ADI recommended programming sequence. This sequence must be followed exactly when setting up the decoder.
0x50	0x20	Recommended setting.
0x52	0x18	Recommended setting.
0x58	0xED	Recommended setting.
0x77	0xC5	Recommended setting.
0x7C	0x93	Recommended setting.
0x7D	0x00	Recommended setting.
0x90	0xC9	Recommended setting.
0x91	0x40	Recommended setting.
0x92	0x3C	Recommended setting.
0x93	0xCA	Recommended setting.
0x94	0xD5	Recommended setting.
0xCF	0x50	Recommended setting.
0xD0	0x4E	Recommended setting.
0xD6	0xDD	Recommended setting.
0xE5	0x51	Recommended setting.
0xD5	0xA0	Recommended setting.
0xD7	0xEA	Recommended setting.
0xE4	0x3E	Recommended setting.
0xE9	0xE3	Recommended setting.
0xEA	0x0F	Recommended setting.
0x0E	0x00	Recommended setting.

# ADV7181B

## Mode 3 525i/625i YPrPb Input (Y on AIN1, Pr on AIN3, and Pb on AIN5)

All standards are supported through autodetect, 8-bit, ITU-R BT.656 output on P15 to P8.

Table 88. Mode 3 YPrPb Input 525i/625i

Register Address	Register Value	Notes
0x00	0x0A	YPrPb input.
0x1D	0x40	Enable 28 MHz crystal.
0x0F	0x40	TRAQ.
0x3D	0xC3	MWE enable manual window.
0x3F	0xE4	BGB to 36.
0x50	0x04	Set DNR threshold.
0xC3	0xC9	Manual mux AIN1 to ADC0 (1001), AIN3 to ADC1 (1100).
0xC4	0x8D	Enable manual muxing, Man mux AIN5 to ADC2 (1101).
0x0E	0x80	ADI recommended programming sequence. This sequence must be followed exactly when setting up the decoder.
0x52	0x18	Recommended setting.
0x58	0xED	Recommended setting.
0x77	0xC5	Recommended setting.
0x7C	0x93	Recommended setting.
0x7D	0x00	Recommended setting.
0x90	0xC9	Recommended setting.
0x91	0x40	Recommended setting.
0x92	0x3C	Recommended setting.
0x93	0xCA	Recommended setting.
0x94	0xD5	Recommended setting.
0xCF	0x50	Recommended setting.
0xD0	0x4E	Recommended setting.
0xD6	0xDD	Recommended setting.
0xE5	0x51	Recommended setting.
0xD5	0xA0	Recommended setting.
0xE4	0x3E	Recommended setting.
0xE9	0x3E	Recommended setting.
0x0E	0x00	Recommended setting.

**Mode 4 CVBS Tuner Input CVBS PAL on AIN6**

All standards are supported through autodetect, 8-bit, ITU-R BT.656 output on P15 to P8.

**Table 89. Mode 4 Tuner Input CVBS PAL Only**

Register Address	Register Value	Notes
0x00	0x80	Force PAL input only mode.
0x07	0x01	Enable PAL autodetection only.
0x15	0x00	Slow down digital clamps.
0x17	0x41	Set CSFM to SH1.
0x19	0xFA	Stronger dot crawl reduction.
0x1D	0x40	Enable 28 MHz crystal.
0x0F	0x40	TRAQ.
0x3A	0x16	Power down ADC 1 and ADC 2.
0x3D	0xC3	MWE enable manual window.
0x3F	0xE4	BGB to 36.
0x50	0x0A	Set higher DNR threshold.
0xC3	0x05	Manual mux AIN6 to ADC0 (0101).
0xC4	0x80	Enable manual muxing.
0x0E	0x80	ADI recommended programming sequence. This sequence must be followed exactly when setting up the decoder.
0x50	0x20	Recommended setting.
0x52	0x18	Recommended setting.
0x58	0xED	Recommended setting.
0x77	0xC5	Recommended setting.
0x7C	0x93	Recommended setting.
0x7D	0x00	Recommended setting.
0x90	0xC9	Recommended setting.
0x91	0x40	Recommended setting.
0x92	0x3C	Recommended setting.
0x93	0xCA	Recommended setting.
0x94	0xD5	Recommended setting.
0xCF	0x50	Recommended setting.
0xD0	0x4E	Recommended setting.
0xD6	0xDD	Recommended setting.
0xE5	0x51	Recommended setting.
0xD5	0xA0	Recommended setting.
0xD7	0xEA	Recommended setting.
0xE4	0x3E	Recommended setting.
0xE9	0x3E	Recommended setting.
0xEA	0x0F	Recommended setting.
0x0E	0x00	Recommended setting.

# ADV7181B

## EXAMPLES FOR 27 MHz CLOCK

### Mode 1 CVBS Input (Composite Video on AIN6)

All standards are supported through autodetect, 8-bit, 4:2:2, ITU-R BT.656 output on P15 to P8.

Table 90. Mode 1 CVBS Input

Register Address	Register Value	Notes
0x15	0x00	Slow down digital clamps.
0x17	0x41	Set CSFM to SH1.
0x3A	0x16	Power down ADC 1 and ADC 2.
0x50	0x04	Set DNR threshold.
0xC3	0x05	Manual mux AIN6 to ADC0 (0101).
0xC4	0x80	Enable manual muxing.
0x0E	0x80	ADI recommended programming sequence. This sequence must be followed exactly when setting up the decoder.
0x50	0x20	Recommended setting.
0x52	0x18	Recommended setting.
0x58	0xED	Recommended setting.
0x77	0xC5	Recommended setting.
0x7C	0x93	Recommended setting.
0x7D	0x00	Recommended setting.
0xD0	0x48	Recommended setting.
0xD5	0xA0	Recommended setting.
0xD7	0xEA	Recommended setting.
0xE4	0x3E	Recommended setting.
0xEA	0x0F	Recommended setting.
0xE9	0x3E	Recommended setting.
0x0E	0x00	Recommended setting.

### Mode 2 S-Video Input (Y on AIN1 and C on AIN4)

All standards are supported through autodetect, 8-bit, ITU-R BT.656 output on P15 to P8.

Table 91. Mode 2 S-Video Input

Register Address	Register Value	Notes
0x00	0x06	S-Video input.
0x15	0x00	Slow down digital clamps.
0x3A	0x12	Power down ADC 2.
0x50	0x04	Set DNR threshold.
0xC3	0x41	Manual mux AIN2 to ADC0 (0001), AIN4 to ADC1 (0100).
0xC4	0x80	Enable manual muxing.
0x0E	0x80	ADI recommended programming sequence. This sequence must be followed exactly when setting up the decoder.
0x50	0x20	Recommended setting.
0x52	0x18	Recommended setting.
0x58	0xED	Recommended setting.
0x77	0xC5	Recommended setting.
0x7C	0x93	Recommended setting.
0x7D	0x00	Recommended setting.
0xD0	0x48	Recommended setting.
0xD5	0xA0	Recommended setting.
0xD7	0xEA	Recommended setting.
0xE4	0x3E	Recommended setting.
0xE9	0xE3	Recommended setting.
0xEA	0x0F	Recommended setting.
0x0E	0x00	Recommended setting.

**Mode 3 525i/625i YPrPb Input (Y on AIN1, Pr on AIN3, and Pb on AIN5)**

All standards are supported through autodetect, 8-bit, ITU-R BT.656 output on P15 to P8.

**Table 92. Mode 3 YPrPb Input 525i/625i**

Register Address	Register Value	Notes
0x00	0x0A	YPrPb Input.
0x50	0x04	Set DNR threshold.
0xC3	0xC9	Manual mux AIN1 to ADC0 (1001), AIN3 to ADC1 (1100).
0xC4	0x8D	Enable manual muxing, manual mux AIN5 to ADC2 (1101).
0x0E	0x80	ADI recommended programming sequence. This sequence must be followed exactly when setting up the decoder.
0x52	0x18	Recommended setting.
0x58	0xED	Recommended setting.
0x77	0xC5	Recommended setting.
0x7C	0x93	Recommended setting.
0x7D	0x00	Recommended setting.
0xD0	0x48	Recommended setting.
0xD5	0xA0	Recommended setting.
0xE4	0x3E	Recommended setting.
0xE9	0x3E	Recommended setting.
0x0E	0x00	Recommended setting.

# ADV7181B

## Mode 4 CVBS Tuner Input CVBS PAL on AIN6

All standards are supported through autodetect, 8-bit, ITU-R BT.656 output on P15 to P8.

Table 92. Mode 4 Tuner Input CVBS PAL Only

Register Address	Register Value	Notes
0x00	0x80	Force PAL input only mode.
0x07	0x01	Enable PAL autodetection only.
0x15	0x00	Slow down digital clamps.
0x17	0x41	Set CSFM to SH1.
0x19	0xFA	Stronger dot crawl reduction.
0x3A	0x16	Power down ADC 1 and ADC 2.
0x50	0x0A	Set higher DNR threshold.
0xC3	0x05	Manual mux AIN6 to ADC0 (0101).
0xC4	0x80	Enable manual muxing.
0x0E	0x80	ADI recommended programming sequence. This sequence must be followed exactly when setting up the decoder.
0x50	0x20	Recommended setting.
0x52	0x18	Recommended setting.
0x58	0xED	Recommended setting.
0x77	0xC5	Recommended setting.
0x7C	0x93	Recommended setting.
0x7D	0x00	Recommended setting.
0xD0	0x48	Recommended setting.
0xD5	0xA0	Recommended setting.
0xD7	0xEA	Recommended setting.
0xE4	0x3E	Recommended setting.
0xE9	0x3E	Recommended setting.
0xEA	0x0F	Recommended setting.
0x0E	0x00	Recommended setting.

## PCB LAYOUT RECOMMENDATIONS

The ADV7181B is a high precision, high speed mixed-signal device. To achieve the maximum performance from the part, it is important to have a PCB board with a good layout. The following is a guide for designing a board using the ADV7181B.

### ANALOG INTERFACE INPUTS

Care should be taken when routing the inputs on the PCB. Track lengths should be kept to a minimum, and  $75\ \Omega$  trace impedances should be used when possible. Trace impedances other than  $75\ \Omega$  also increase the chance of reflections.

### POWER SUPPLY DECOUPLING

It is recommended to decouple each power supply pin with  $0.1\ \mu\text{F}$  and  $10\ \text{nF}$  capacitors. The fundamental idea is to have a decoupling capacitor within about  $0.5\ \text{cm}$  of each power pin. Also, avoid placing the capacitor on the opposite side of the PCB board from the ADV7181B, as doing so interposes resistive vias in the path. The decoupling capacitors should be located between the power plane and the power pin. Current should flow from the power plane to the capacitor to the power pin. Do not make the power connection between the capacitor and the power pin. Placing a via underneath the  $100\ \text{nF}$  capacitor pads, down to the power plane, is generally the best approach (see Figure 40).

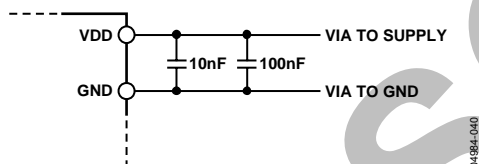

Figure 40. Recommended Power Supply Decoupling

It is particularly important to maintain low noise and good stability of PVDD. Careful attention must be paid to regulation, filtering, and decoupling. It is highly desirable to provide separate regulated supplies for each of the analog circuitry groups (AVDD, DVDD, DVDDIO, and PVDD).

Some graphic controllers use substantially different levels of power when active (during active picture time) and when idle (during horizontal and vertical sync periods). This can result in a measurable change in the voltage supplied to the analog supply regulator, which can, in turn, produce changes in the regulated analog supply voltage. This can be mitigated by regulating the analog supply, or at least PVDD, from a different, cleaner power source, for example, from a  $12\ \text{V}$  supply.

It is also recommended to use a single ground plane for the entire board. This ground plane should have a space between the analog and digital sections of the PCB (see Figure 41).

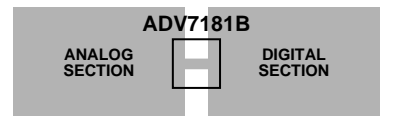

Figure 41. PCB Ground Layout

Experience has repeatedly shown that the noise performance is the same or better with a single ground plane. Using multiple ground planes can be detrimental because each separate ground plane is smaller and long ground loops can result.

In some cases, using separate ground planes is unavoidable. For those cases, it is recommended to place a single ground plane under the ADV7181B. The location of the split should be under the ADV7181B. For this case, it is even more important to place components wisely because the current loops are much longer (current takes the path of least resistance). An example of a current loop: power plane to ADV7181B to digital output trace to digital data receiver to digital ground plane to analog ground plane.

### PLL

Place the PLL loop filter components as close as possible to the ELPF pin. Do not place any digital or other high frequency traces near these components. Use the values suggested in the data sheet with tolerances of 10% or less.

### DIGITAL OUTPUTS (BOTH DATA AND CLOCKS)

Try to minimize the trace length the digital outputs have to drive. Longer traces have higher capacitance, which requires more current, which causes more internal digital noise. Shorter traces reduce the possibility of reflections.

Adding a  $30\ \Omega$  to  $50\ \Omega$  series resistor can suppress reflections, reduce EMI, and reduce the current spikes inside the ADV7181B. If series resistors are used, place them as close as possible to the ADV7181B pins. However, try not to add vias or extra length to the output trace to make the resistors closer.

If possible, limit the capacitance that each of the digital outputs drives to less than  $15\ \text{pF}$ . This can easily be accomplished by keeping traces short and by connecting the outputs to only one device. Loading the outputs with excessive capacitance increases the current transients inside the ADV7181B, creating more digital noise on its power supplies.

# ADV7181B

## DIGITAL INPUTS

The digital inputs on the ADV7181B are designed to work with 3.3 V signals, and are not tolerant of 5 V signals. Extra components are needed if 5 V logic signals are required to be applied to the decoder.

## ANTI\_ALIASING FILTERS

For inputs from some video sources that are not bandwidth limited, signals outside the video band can alias back into the video band during A/D conversion and appear as noise on the output video. The ADV7181B oversamples the analog inputs by a factor of 4. This 54 MHz sampling frequency reduces the requirement for an input filter; for optimal performance it is recommended an antialiasing filter be used. The recommended low-cost circuit for implementing this buffer and filter circuit for all analog input signals is shown in Figure 44.

The buffer is a simple emitter-follower using a single npn transistor. The antialiasing filter is implemented using passive components. The passive filter is a third-order Butterworth filter with a  $-3$  dB point of 9 MHz. The frequency response of the passive filter is shown in Figure 42. The flat pass band up to 6 MHz is essential. The attenuation of the signal at the output of the filter due to the voltage divider of R24 and R63 is compensated for in the ADV7181B part using the automatic gain control.

The ac-coupling capacitor at the input to the buffer creates a high-pass filter with the biasing resistors for the transistor. This filter has a cut-off of

$$\{2 \times \pi \times (R39 \parallel R89) \times C93\}^{-1} = 0.62 \text{ Hz}$$

It is essential the cutoff of this filter be less than 1 Hz to ensure correct operation of the internal clamps within the part. These clamps ensure the video stays within the 5 V range of the op amp used.

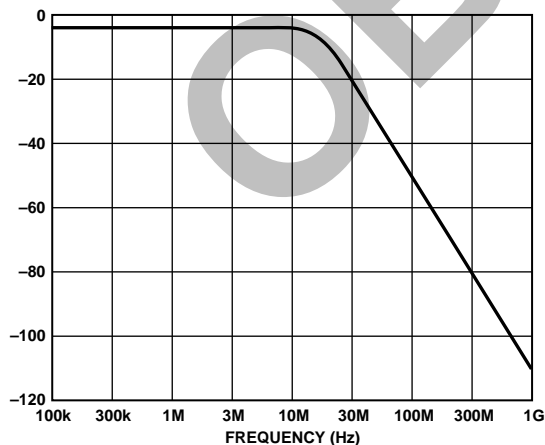

Figure 42. Third-Order Butterworth Filter Response

## CRYSTAL LOAD CAPACITOR VALUE SELECTION

Figure 43 shows an example reference clock circuit for the a ADV7181B. Special care must be taken when using a crystal circuit to generate the reference clock for the ADV7181B. Small variations in reference clock frequency can cause autodetection issues and impair the ADV7181B performance.

Load capacitor values are dependant on crystal attributes.

The load capacitance given in a crystal data sheet specifies the parallel resonance frequency within the tolerance at 25°C. It is therefore important to design a circuit that matches the load capacitance in order to achieve the frequency stipulated by the manufacturer. For detailed crystal circuit design and optimization, an applications note on crystal design considerations is available for reference.

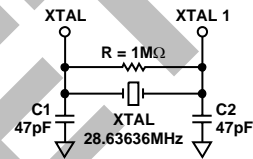

Figure 43. Crystal Circuit

Use the following guidelines to ensure correct operation:

- Use the correct frequency crystal, which is 28.63636 MHz. Tolerance should be 50 ppm or better.
- Use a parallel-resonant crystal.
- Place a 1 MΩ shunt resistor across pins XTAL1 and XTAL2 as is shown in Figure 43.
- Know the  $C_{LOAD}$  for the crystal part number selected. The value of Capacitors C1 and C2 must match  $C_{LOAD}$  for the specific crystal part number in the user's system.

To determine  $C_{LOAD}$ , use the following guideline:

$$C1 = C2 = C$$

$$C = 2 ( C_{LOAD} - C_s ) - C_{pg}$$

where:

$C_{pg}$  is the pin-to-ground capacitance; approximately 4 pF to 10 pF.

$C_s$  is the PCB stray capacitance, approximately 2 pF to-3 pF.

For example,

$$C_{LOAD} = 30 \text{ pF}$$

$$C = 2 ( 30 - 3 ) - 4$$

$$= 50 \text{ pF}$$

Therefore, two 47 pF capacitors can be chosen for C1 and C2.



## TYPICAL CIRCUIT CONNECTION

Examples of how to connect the ADV7181B video decoder are shown in Figure 44 and Figure 45. For a detailed schematic diagram for the ADV7181B, refer to the ADV7181B evaluation note.

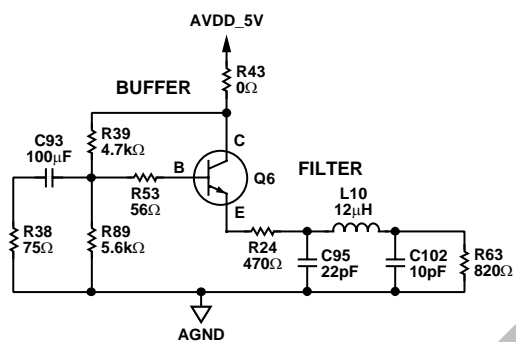

Figure 44. ADI Recommended Antialiasing Circuit for All Input Channels

# ADV7181B

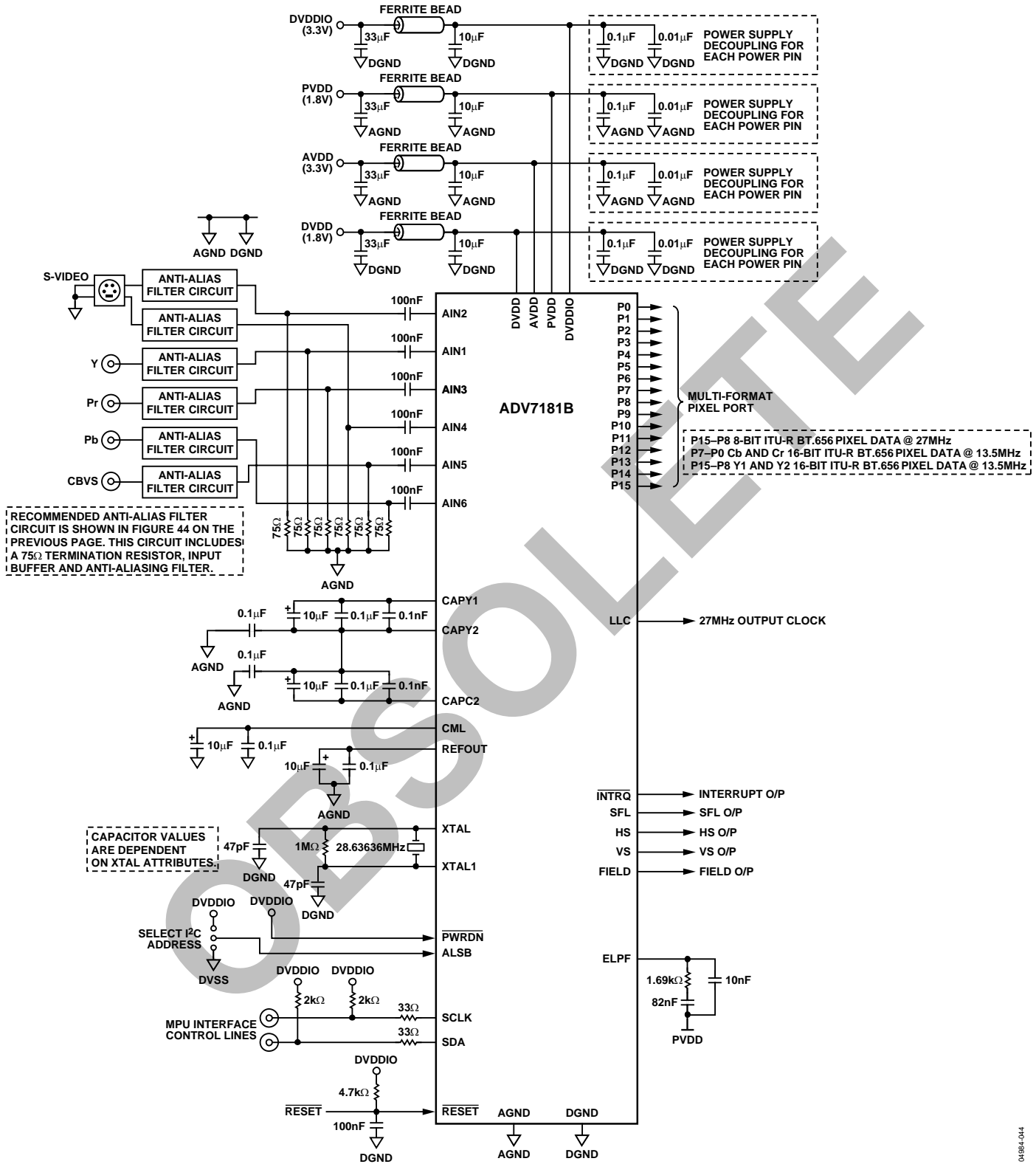
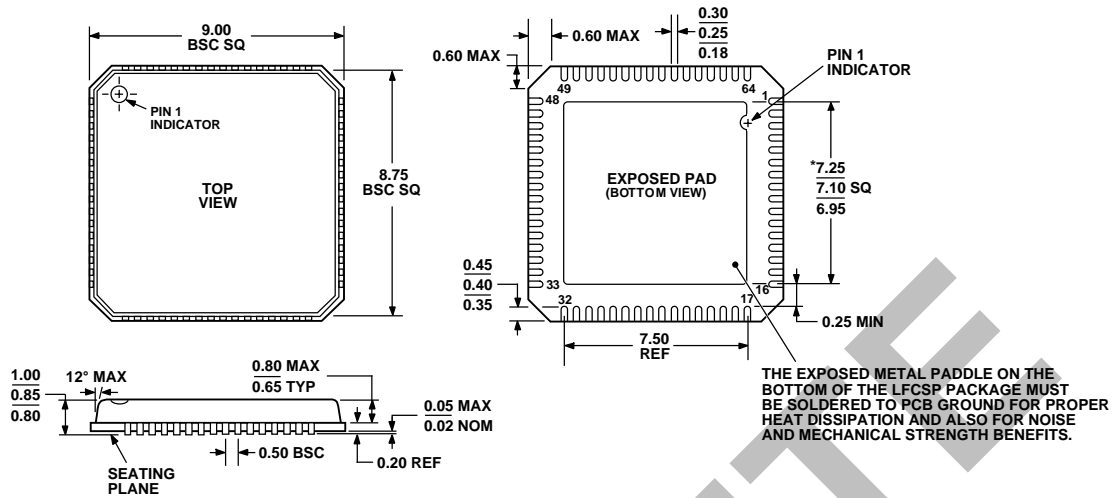

Figure 45. Typical Connection Diagram

# OUTLINE DIMENSIONS



\*COMPLIANT TO JEDEC STANDARDS MO-220-VMMD EXCEPT FOR EXPOSED PAD DIMENSION

Figure 46. 64-Lead Lead Frame Chip Scale Package [LFCSP\_VQ]  
9 x 9 mm Body, Very Thin Quad (CP-64-3)  
Dimensions shown in millimeters

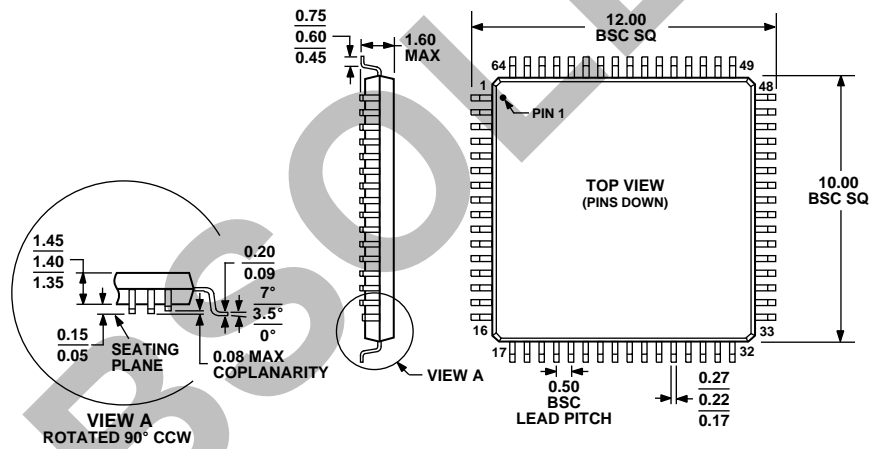

COMPLIANT TO JEDEC STANDARDS MS-026-BCD

Figure 47. 64-Lead Low Profile Quad Flat Package [LQFP]  
(ST-64-2)

Dimensions shown in millimeters

# ADV7181B

## ORDERING GUIDE

Model <sup>1</sup>	Temperature Range	Package Description	Package Option
ADV7181BBCPZ <sup>2</sup>	-40°C to +85°C	Lead Frame Chip Scale Package (LFCSP_VQ)	CP-64-3
ADV7181BBSTZ <sup>2</sup>	-40°C to +85°C	Low Profile Quad Flat Package (LQFP)	ST-64-2
EVAL-ADV7181BEB		Evaluation Board	

<sup>1</sup> The ADV7181B is a Pb-free, environmentally friendly product. It is manufactured using the most up-to-date materials and processes. The coating on the leads of each device is 100% pure Sn electroplate. The device is suitable for Pb-free applications and can withstand surface-mount soldering at up to 255°C (±5°C). In addition, it is backward-compatible with conventional SnPb soldering processes. This means the electroplated Sn coating can be soldered with Sn/Pb solder pastes at conventional reflow temperatures of 220°C to 235°C.

<sup>2</sup> Z = Pb-free part.

Purchase of licensed I<sup>2</sup>C components of Analog Devices or one of its sublicensed Associated Companies conveys a license for the purchaser under the Philips I<sup>2</sup>C Patent Rights to use these components in an I<sup>2</sup>C system, provided that the system conforms to the I<sup>2</sup>C Standard Specification as defined by Philips.

OBSOLETE