



General Description

The AF2576 series of regulators are monolithic integrated circuits that provide all the active functions for a step-down (buck) switching regulator, capable of driving 3A load with excellent line and load regulation. These devices are available in fixed output voltages of 3.3V, 5V, 12V, 15V and adjustable output versions.

Requiring a minimum number of external components, these regulators are simple to use and include internal frequency compensation and a fixed-frequency oscillator.

The AF2576 series offers a high-efficiency replacement for popular three-terminal linear regulators. It substantially reduces the size of the heat sink, and in some cases no heat sink is required.

A standard series of inductors optimized for use with the AF2576 is available from several different manufacturers. This feature greatly simplifies the design of switch-mode power supplies.

Other features include a guaranteed 4% tolerance on the output voltage within specified input voltages and output load conditions, and 10% tolerance on the oscillator frequency. An external shutdown is included, featuring 50 A (typical) standby current. The output switch includes cycle-by-cycle current limiting, as well as a thermal shutdown for full protection under fault conditions.

Features

- ◆ Inherently Matched LED Current
- ◆ 3.3V, 5V, 12V, 15V and adjustable output versions
- ◆ Adjustable version output voltage range, 1.23V to 37V (±4%) max over line and load conditions
- ◆ Guaranteed 3A output current
- ◆ Wide input voltage range, 40V
- ◆ Requires only 4 external components
- ◆ 52 kHz fixed frequency oscillator
- ◆ TTL shutdown capability, low power standby mode
- ◆ High efficiency
- ◆ Uses readily available standard inductors
- ◆ Thermal shutdown and current limit protection

Application

- Simple high-efficiency step-down (buck) regulator
- Efficient pre-regulator for linear regulators
- On-card switching regulators
- Positive to negative converter (Buck-Boost)

Pin Define

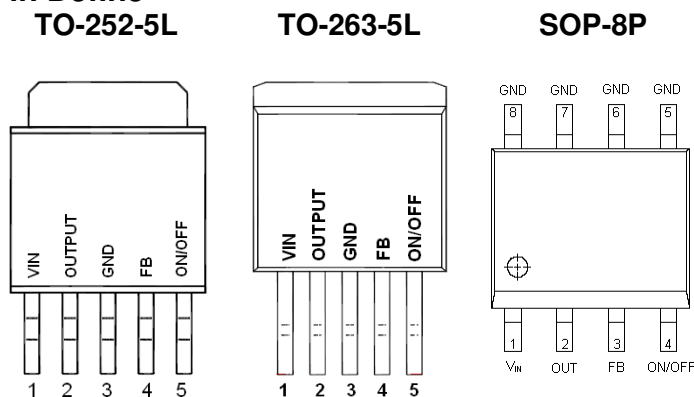

Marking Information

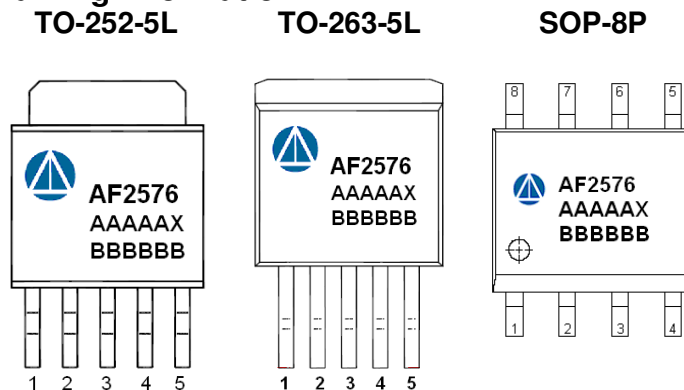



Block Diagram

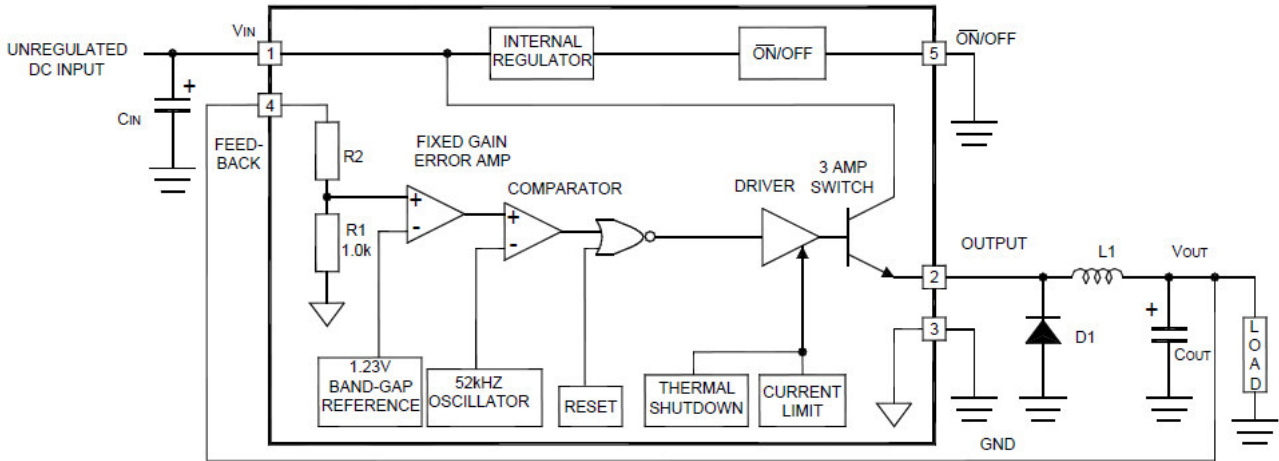

Typical Application Circuit

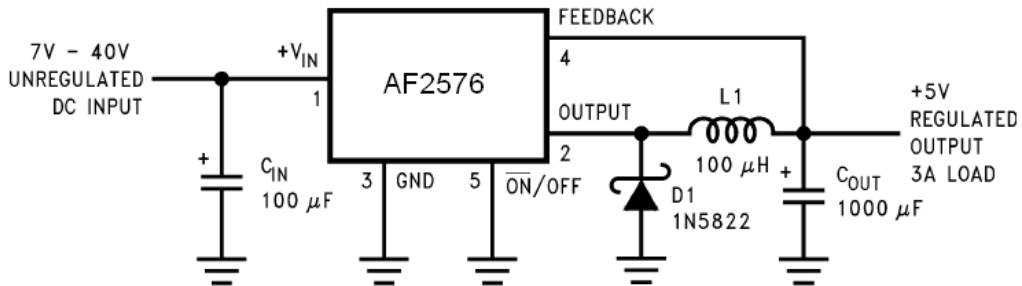

Pin Description (TO-252-5L / TO-263-5L)

Pin	Symbol	Description
1	VIN	Supply Voltage Input Pin
2	OUTPUT	Output Voltage Pin
3	GND	Ground Pin
4	FB	Feedback Pin.
5	ON/OFF	

Ordering Information

Part Number	Package	Output Voltage	Part Marking	Unit	Quantity
AF2576T255RG-ADJ	TO-252-5L	Adj	AF2576	Tape & Reel	2500 EA
AF2576T265RG-ADJ	TO-263-5L	Adj	AF2576	Tape & Reel	800 EA
AF2576S8RG-ADJ	SOP-8P	Adj	AF2576	Tape & Reel	2500 EA

- ※ A Lot code
- ※ B Date code
- ※ X voltage code (A: Adj)
- ※ AF2576T255RG-ADJ / AF2576T265RG-ADJ / AF2576S8RG-ADJ: 13" Tape Reel ; Pb- Free ; Halogen- Free



Absolute Maximum Ratings (T_A=25°C Unless otherwise noted)

Parameter	Symbol	Value	Unit
Maximum Supply Voltage	V _{in}	45	V
Operation Supply Voltage	V _{in(OPER)}	40	V
ON/OFF Pin Input Voltage	V _{ON/OFF}	-0.3 ~ V _{in}	V
Output Voltage to GND (Steady-state)	V _{ss}	-0.8	V
Power Dissipation	P _D	Internally-limited	V
Maximum ESD rating (C=100pF, R=1.5kOhm)	ESD	2	KV
Operating Temperature	T _{OPR}	-40 ~ 125	°C
Maximum Junction Temperature	T _{J(Max)}	150	°C
Storage Temperature	T _S	-65 ~ 150	°C
Lead temperature (soldering, 10 seconds)	T _{Lead}	260	°C

AF2576T255RG-ADJ / AF2576T265RG-ADJ Electrical Characteristics

(T_J = 25 C, and apply over the full operating Temperature Range)

Symbol	Parameter	Conditions	Typ	Limit	Units (Limits)
SYSTEM PARAMETERS (Follow as AF2576T252RG-ADJ / AF2576T263RG-ADJ Test Circuit)					
V _{OUT}	Feedback Voltage	V _{IN} = 12V, I _{LOAD} = 0.5A, V _{OUT} = 5V	1.230	1.217 1.243	V(Min) V(Max)
V _{OUT}	Feedback Voltage	8V ≤ V _{IN} ≤ 40V, 0.5A ≤ I _{LOAD} ≤ 3A, V _{OUT} = 5V	1.230	1.193/1.180 1.267/1.280	V(Min) V(Max)
η	Efficiency	V _{IN} = 12V, I _{LOAD} = 3A, V _{OUT} = 5V	77		%

AF2576T255RG-ADJ / AF2576T265RG-ADJ Test Circuit

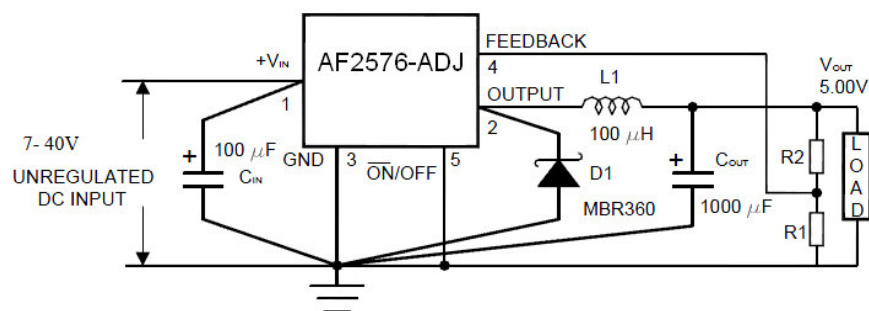

$$V_{OUT} = V_{REF} \left(1 + \frac{R_2}{R_1} \right)$$

$$R_2 = R_1 \left(\frac{V_{OUT}}{V_{REF}} - 1 \right)$$

Where V_{REF} = 1.23V, R₁ between 1k and 5k



AF2576T255RG-ADJ / AF2576T265RG-ADJ Output Voltage Electrical Characteristics

($T_J = 25\text{ C}$, and apply over the Full Operating Temperature Range. $V_{IN} = 12\text{V}$ for adjustable versions)

Symbol	Parameter	Conditions	Typ	Limit (Note 2)	Units (Limits)
DEVICE PARAMETERS					
I_B	Feedback bias current	$V_{OUT} = 5\text{V}$	50	100/500	nA
F_O	Oscillator frequency	(Note 8)	52	47/42 58/63	kHz kHz (Min) kHz (Max)
V_{SAT}	Saturation voltage	$I_{OUT} = 3\text{A}$ (Note 4)	1.4	1.6/1.8	V V(Max)
$DC_{(Max)}$	Max duty cycle (ON)	(Note 5)	98	93	% %(Min)
I_{CL}	Current limit	(Notes 4, 8)	5.8	4.2/3.5 6.9/7.5	A A(Min) A(Max)
I_L	Output leakage current	(Notes 6, 7): Output = 0V Output = -0.8V Output = -0.8V	7.5	2 30	mA(Max) mA mA(Max)
I_Q	Quiescent current	(Note 6)	5	10	mA mA(Max)
I_{STBY}	Standby quiescent current	$\overline{\text{ON/OFF}}$ pin = 5V (OFF)	50	200	μA μA (Max)

Note 1: The Absolute Maximum Ratings indicate limits beyond which damage to the device may occur. The Operating Ratings indicate conditions for which the device is intended to be functional, but do not guarantee specific performance limits. For guaranteed specifications and test conditions, see the Electrical Characteristics.

Note 2: All the Limits are guaranteed at room temperature (standard type face) and at temperature extremes (boldface type).

Note 3: External components such as catch diode, inductor, input and output capacitors can affect the switching regulator system performance. When the AF2576 is used as shown in the **AF2576T255RG-ADJ / AF2576T265RG-ADJ test circuit**, the system performance will be as shown in the system parameters section of the Electrical Characteristics.

Note 4: Output Pin sourcing current. No diode, inductor or capacitor connected to the OUTPUT.

Note 5: Feedback pin is removed from the output and connected to 0V.

Note 6: Feedback pin is removed from the output and connected to +12V for the adjustable version, to force the output transistor OFF.

Note 7: $V_{IN} = 40\text{V}$.

Note 8: The oscillator frequency reduces to approximately 11 kHz in the event of an output short or an overload, which causes the regulated output voltage to drop approximately 40% from the nominal output voltage. This self-protection feature lowers the average power dissipation of the IC by lowering the minimum duty cycle from 5% down to approximately 2%.



AF2576T255RG-ADJ / AF2576T265RG-ADJ

Output Voltage Electrical Characteristics(Continued)

(T_J = 25 C, and apply over the Full Operating Temperature Range. V_{IN} = 12V for adjustable versions)

Symbol	Parameter	Conditions	Typ	Limit	Units (Limits)
$\overline{\text{ON/OFF}}$ CONTROL					
V _{IH}	$\overline{\text{ON/OFF}}$ pin logic input level	V _{OUT} = 0V	1.4	2.2/2.4	V(Min)
V _{IL}		V _{OUT} = nominal output voltage	1.2	1.0/0.8	V(Max)
I _{IH}	$\overline{\text{ON/OFF}}$ pin input current	$\overline{\text{ON/OFF}}$ pin = 5V (OFF)	12	30	μA $\mu\text{A}(\text{Max})$
I _{IL}		$\overline{\text{ON/OFF}}$ pin = 0V (ON)	0	10	μA $\mu\text{A}(\text{Max})$



Typical Performance Characteristics

Normalized Output Voltage

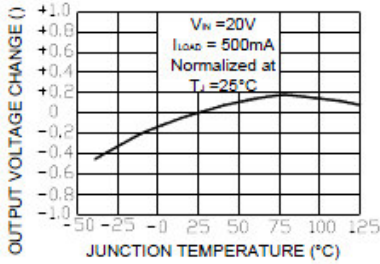

Line Regulation

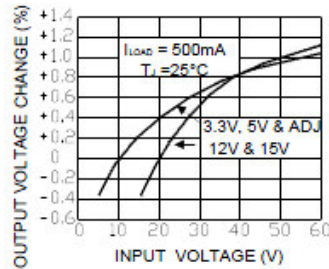

Dropout Voltage

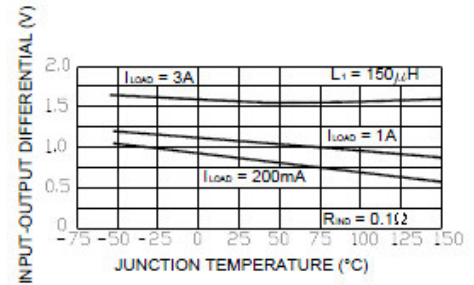

Standby Quiescent Current

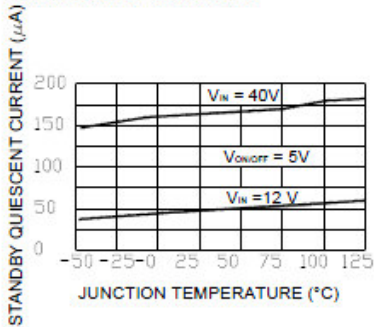

Quiescent Current

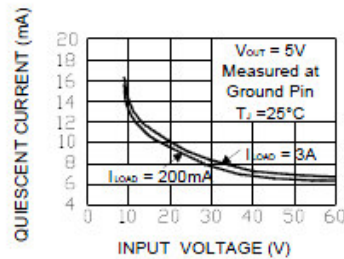

Current Limit

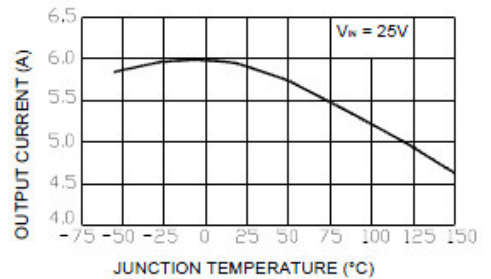

Switch Saturation Voltage

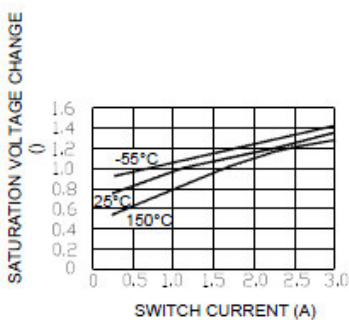

Efficiency

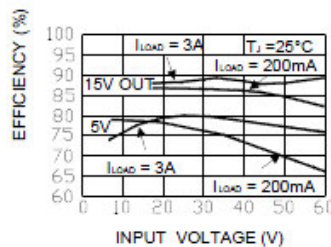

Oscillator Frequency

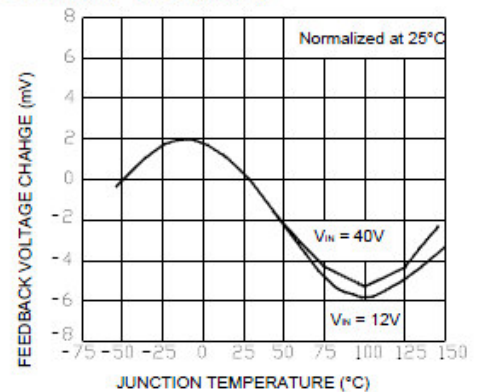



Typical Performance Characteristics(Continued)

Minimum Operating Voltage

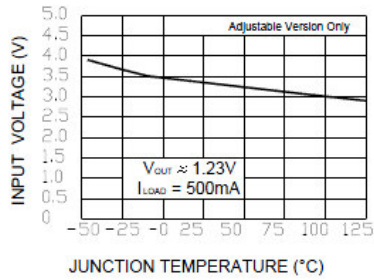

Quiescent Current vs Duty Cycle

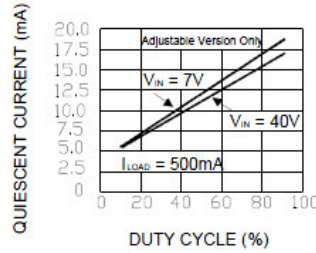

Feedback Voltage vs Duty Cycle

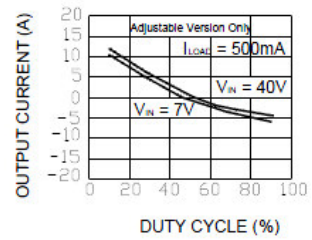

Maximum Power Dissipation (TO-263)

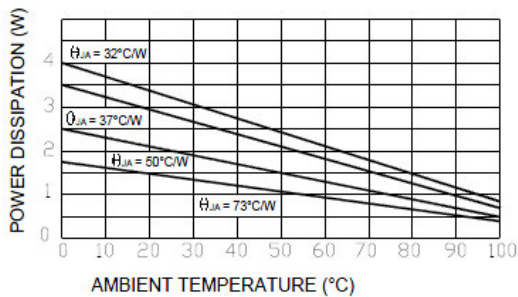

Feedback Pin Current

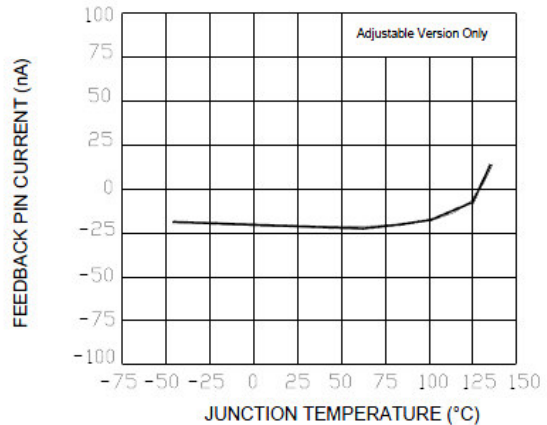



Typical Performance Characteristics(Continued)

Switching Waveforms

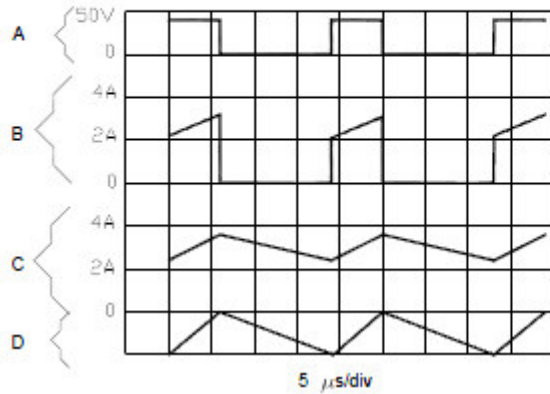

Load Transient Response

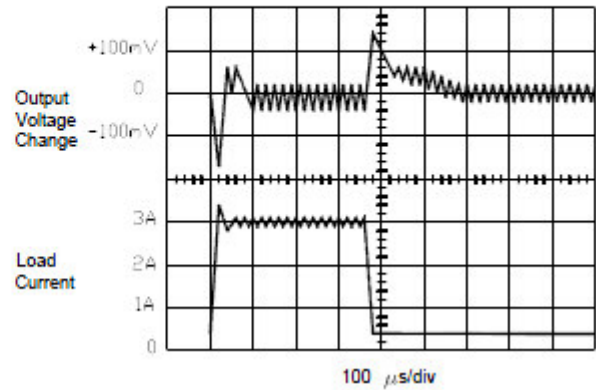

$V_{OUT} = 15V$

A: OUTPUT pin voltage, 50V/div

B: OUTPUT pin current, 2A/div

C: Inductor current, 2A/div

D: Output ripple voltage, 50mV/div,

AC-coupled

Horizontal Time Base: 5 μ s/div



Package Information (TO-252-5L)

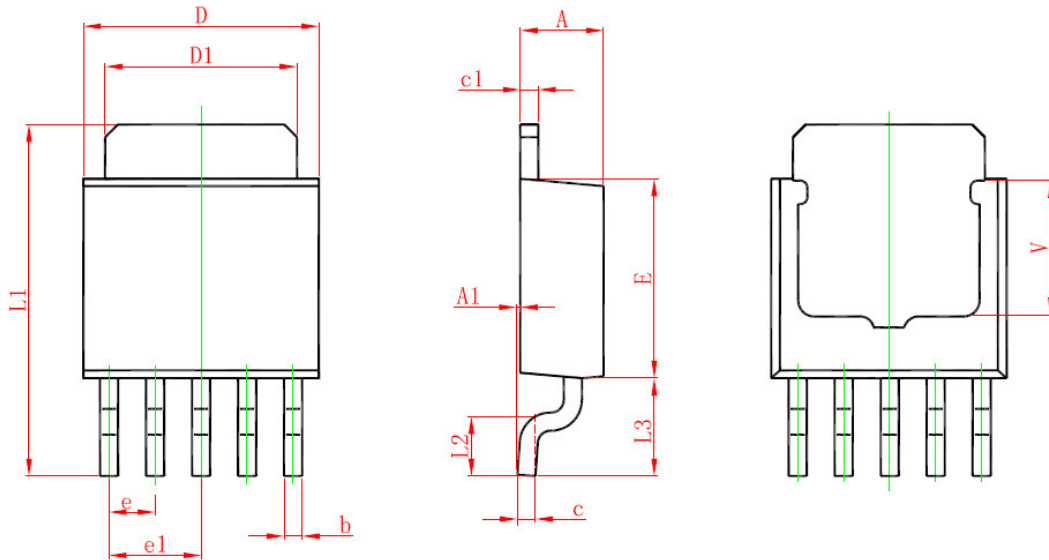

Symbol	Dimensions In Millimeters		Dimensions In Inches	
	Min	Max	Min	Max
A	2.200	2.400	0.087	0.094
A1	0.000	0.127	0.000	0.005
b	0.400	0.600	0.016	0.024
c	0.430	0.580	0.017	0.023
c1	0.430	0.580	0.017	0.023
D	6.350	6.650	0.250	0.262
D1	5.200	5.400	0.205	0.213
E	5.400	5.700	0.213	0.224
e	1.270 TYP		0.050 TYP	
e1	2.540 TYP		1.000 TYP	
L1	9.500	9.900	0.374	0.390
L2	1.400	1.780	0.055	0.070
L3	2.550	2.900	0.100	0.114
V	3.800 REF		0.150 REF	

©2010 Alfa-MOS Technology Corp.
 9F.-15, No.3-2, Yuanqu St., Nangang Dist., (NanKang Software Park), Taipei City 115, Taiwan (R.O.C.)
 Tel : 886 2) 2655 7963
 Fax : 886 2) 2655 7098
 ©http://www.alfa-mos.com



Package Information (TO-263-5L)

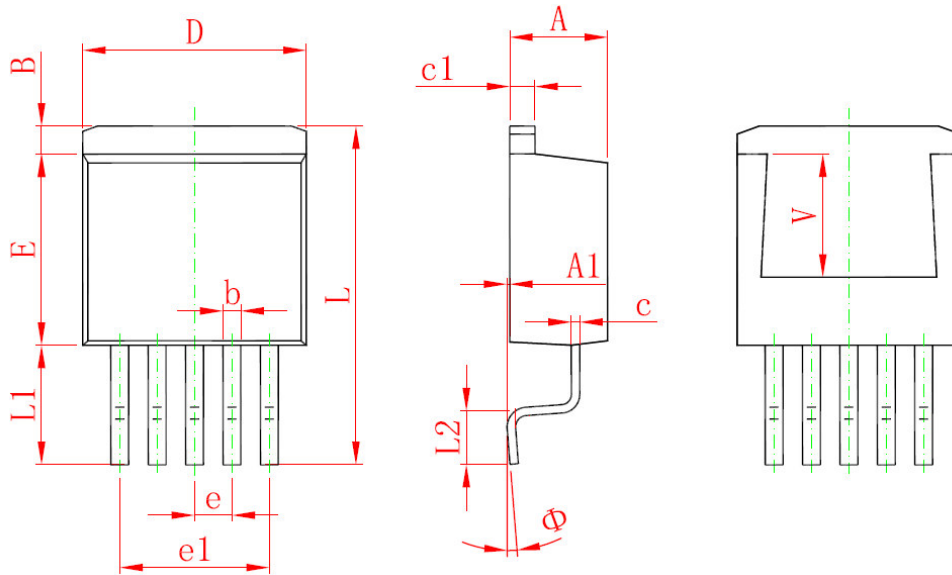

Symbol	Dimensions In Millimeters		Dimensions In Inches	
	Min.	Max.	Min.	Max.
A	4.470	4.670	0.176	0.184
A1	0.000	0.150	0.000	0.006
B	1.560	1.760	0.061	0.069
b	0.710	0.910	0.028	0.036
c	0.310	0.530	0.012	0.021
c1	1.170	1.370	0.046	0.054
D	9.880	10.180	0.389	0.401
E	8.200	8.600	0.323	0.339
e	1.700 TYP.		0.067 TYP.	
e1	6.700	6.900	0.264	0.272
L	15.140	15.540	0.596	0.612
L1	5.080	5.480	0.200	0.216
L2	2.340	2.740	0.092	0.108
Φ	0°	8°	0°	8°
V	5.600 REF.		0.220 REF.	

©2010 Alfa-MOS Technology Corp.
 9F.-15, No.3-2, Yuanqu St., Nangang Dist., (NanKang Software Park), Taipei City 115, Taiwan (R.O.C.)
 Tel : 886 2) 2655 7963
 Fax : 886 2) 2655 7098
 ©http://www.alfa-mos.com



Package Information (SOP-8P)

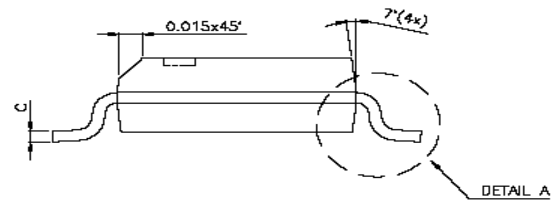
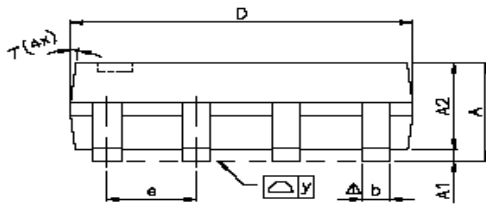
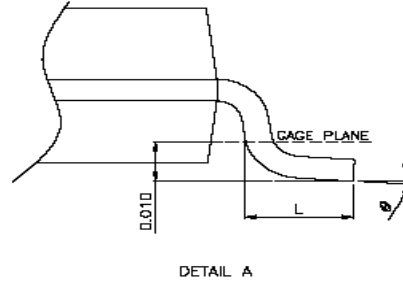
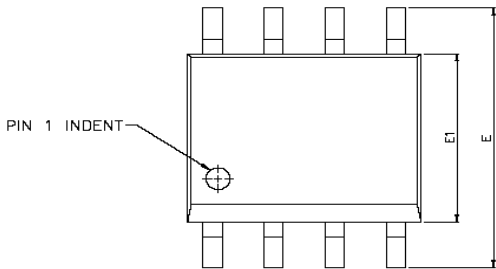

SYMBOLS	DIMENSIONS IN MILLIMETERS			DIMENSIONS IN INCHES		
	MIN	NOM	MAX	MIN	NOM	MAX
A	1.47	1.60	1.73	0.058	0.063	0.068
A1	0.10	—	0.25	0.004	—	0.010
A2	—	1.45	—	—	0.057	—
b	0.33	0.41	0.51	0.013	0.016	0.020
C	0.19	0.20	0.25	0.0075	0.008	0.0098
D	4.80	4.85	4.95	0.189	0.191	0.195
E	5.80	6.00	6.20	0.228	0.236	0.244
E1	3.80	3.90	4.00	0.150	0.154	0.157
e	—	1.27	—	—	0.050	—
L	0.38	0.71	1.27	0.015	0.028	0.050
Δ y	—	—	0.076	—	—	0.003
θ	0°	—	8°	0°	—	8°

©2010 Alfa-MOS Technology Corp.
 2F, No.80, Sec.1, Cheng Kung Rd., Nan Kang Dist., Taipei City 115, Taiwan (R.O.C.)
 Tel : 886 2) 2651 3928
 Fax : 886 2) 2786 8483
 ©http://www.alfa-mos.com