



General Description

AFC5606, N & P Pair enhancement mode MOSFET, uses Advanced Trench Technology to provide excellent $R_{DS(ON)}$, low gate charge. These devices are particularly suited for low voltage power management, and low in-line power loss are needed in commercial industrial surface mount applications.

Features

N-Channel

- 60V/15A, $R_{DS(ON)}=42m\Omega@V_{GS}=10V$
- 60V/12A, $R_{DS(ON)}=50m\Omega@V_{GS}=4.5V$

P-Channel

- -60V/-15A, $R_{DS(ON)}=100m\Omega@V_{GS}=-10V$
- -60V/-12A, $R_{DS(ON)}=120m\Omega@V_{GS}=-4.5V$

Pin Description (TO-252-4L)

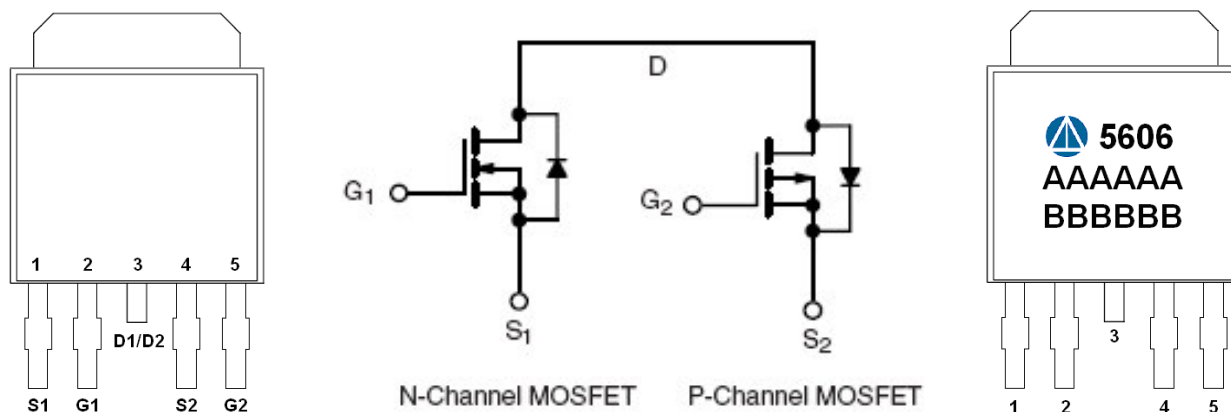

Application

- DC/DC Conversion
- Load Switch
- DC FAN

Pin Define

Pin	Symbol	Description
1	S1	Source 1
2	G1	Gate 1
3	D1 / D2	Drain 1 / Drain 2
4	S2	Source 2
5	G2	Gate 2

Ordering Information

Part Ordering No.	Part Marking	Package	Unit	Quantity
AFC5606T254RG	5606	TO-252-4L	Tape & Reel	2500 EA

- ※ A Lot code
- ※ B Date code
- ※ AFC5606T254RG : 13" Tape & Reel ; Pb- Free ; Halogen- Free



Absolute Maximum Ratings (N-Channel)

(T_A=25°C Unless otherwise noted)

Parameter	Symbol	Typical	Unit
Drain-Source Voltage	V _{DSS}	60	V
Gate –Source Voltage	V _{GSS}	±20	V
Continuous Drain Current(T _J =150°C)	I _D	T _A =25°C	7.0
		T _A =70°C	6.0
Pulsed Drain Current	I _{DM}	20	A
Continuous Source Current(Diode Conduction)	I _S	1.5	A
Power Dissipation	P _D	T _A =25°C	2.8
		T _A =70°C	1.8
Operating Junction Temperature	T _J	150	°C
Storage Temperature Range	T _{STG}	-55/150	°C
Thermal Resistance-Junction to Ambient	R _{θJA}	62.5	°C/W

Electrical Characteristics (N-Channel)

(T_A=25°C Unless otherwise noted)

Parameter	Symbol	Conditions	Min.	Typ	Max.	Unit
Static						
Drain-Source Breakdown Voltage	V _{(BR)DSS}	V _{GS} =0V, I _D =250uA	60			V
Gate Threshold Voltage	V _{GS(th)}	V _{DS} =V _{GS} , I _D =250uA	1.0		2.5	V
Gate Leakage Current	I _{GSS}	V _{DS} =0V, V _{GS} =±20V			±100	nA
Zero Gate Voltage Drain Current	I _{DSS}	V _{DS} =60V, V _{GS} =0V			1	uA
		V _{DS} =60V, V _{GS} =0V T _J =85°C			5	
On-State Drain Current	I _{D(on)}	V _{DS} ≥ 5V, V _{GS} =4.5V	30			A
Drain-Source On-Resistance	R _{DS(on)}	V _{GS} =10V, I _D =15A		38	42	mΩ
		V _{GS} =4.5V, I _D =12A		42	50	
Forward Transconductance	g _{FS}	V _{DS} =15V, I _D =5.3A		24		S
Diode Forward Voltage	V _{SD}	I _S =2.0A, V _{GS} =0V		0.8	1.2	V
Dynamic						
Total Gate Charge	Q _g	V _{DS} =30V, V _{GS} =5V I _D ≅5.6A		10	15	nC
Gate-Source Charge	Q _{gs}			3.5		
Gate-Drain Charge	Q _{gd}			3.6		
Input Capacitance	C _{iss}	V _{DS} =30V, V _{GS} =0V f=1MHz		890		pF
Output Capacitance	C _{oss}			85		
Reverse Transfer Capacitance	C _{rss}			48		
Turn-On Time	t _{d(on)}	V _{DD} =30V, R _L =6.8Ω I _D ≅5.0A, V _{GEN} =4.5V R _G =6Ω		10	15	ns
	t _r			12	20	
Turn-Off Time	t _{d(off)}			25	35	
	t _f			10	15	



Absolute Maximum Ratings (P-Channel)

(T_A=25°C Unless otherwise noted)

Parameter	Symbol	Typical	Unit
Drain-Source Voltage	V _{DSS}	-60	V
Gate –Source Voltage	V _{GSS}	±20	V
Continuous Drain Current(T _J =150°C)	I _D	T _A =25°C	-5.0
		T _A =70°C	-4.0
Pulsed Drain Current	I _{DM}	-30	A
Continuous Source Current(Diode Conduction)	I _S	-1.7	A
Power Dissipation	P _D	T _A =25°C	2.8
		T _A =70°C	1.8
Operating Junction Temperature	T _J	150	°C
Storage Temperature Range	T _{STG}	-55/150	°C
Thermal Resistance-Junction to Ambient	R _{θJA}	62.5	°C/W

Electrical Characteristics (P-Channel)

(T_A=25°C Unless otherwise noted)

Parameter	Symbol	Conditions	Min.	Typ	Max.	Unit
Static						
Drain-Source Breakdown Voltage	V _{(BR)DSS}	V _{GS} =0V, I _D = -250uA	-60			V
Gate Threshold Voltage	V _{G(th)}	V _{DS} =V _{GS} , I _D = -250uA	-0.8		-2.5	
Gate Leakage Current	I _{GSS}	V _{DS} =0V, V _{GS} = ±20V			±100	nA
Zero Gate Voltage Drain Current	I _{DSS}	V _{DS} = -48V, V _{GS} =0V			-1	uA
		V _{DS} = -48V, V _{GS} =0V T _J =85°C			-20	
On-State Drain Current	I _{D(on)}	V _{DS} ≥ -5V, V _{GS} = -10V	-20			A
Drain-Source On-Resistance	R _{DS(on)}	V _{GS} = -10V, I _D =-15A		88	100	mΩ
		V _{GS} = -4.5V, I _D =-12A		98	120	
Forward Transconductance	g _{FS}	V _{DS} = -15V, I _D = -3.2A		12		S
Diode Forward Voltage	V _{SD}	I _S = -2A, V _{GS} =0V		-0.8	-1.2	V
Dynamic						
Total Gate Charge	Q _g	V _{DS} =-30V, V _{GS} =-10V I _D = -4.0A		12	20	nC
Gate-Source Charge	Q _{gs}			2.5		
Gate-Drain Charge	Q _{gd}			3.5		
Input Capacitance	C _{iss}	V _{DS} =-30V, V _{GS} =0V f=1MHz		900		pF
Output Capacitance	C _{oss}			90		
Reverse Transfer Capacitance	C _{rss}			40		
Turn-On Time	t _{d(on)}	V _{DD} =-30V, R _L =7.5Ω I _D ≡ -3.0A, V _{GEN} =-10V R _G =3Ω		10	20	ns
	t _r			6	10	
Turn-Off Time	t _{d(off)}			30	45	
	t _f			12	25	



Typical Characteristics (N-Channel)

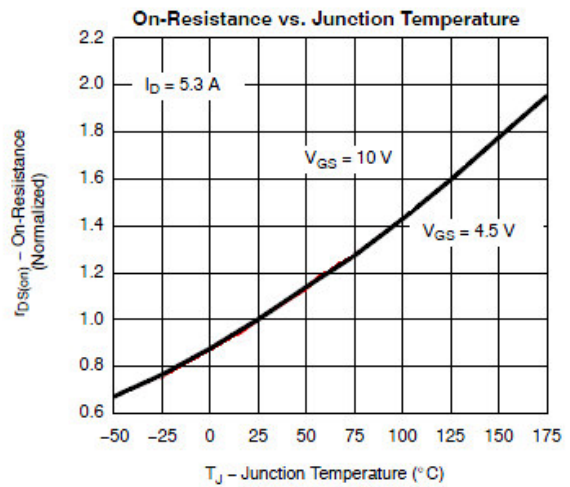
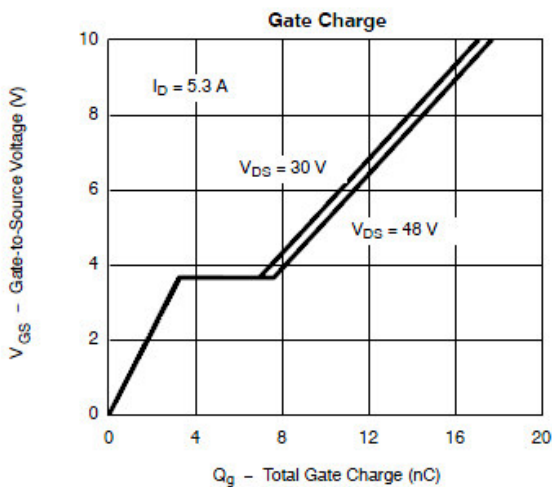
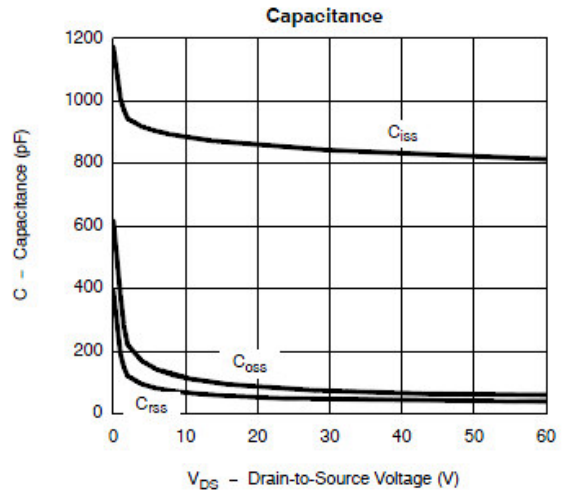
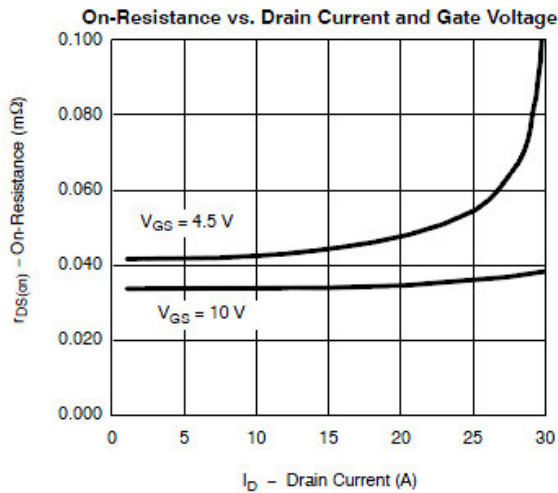
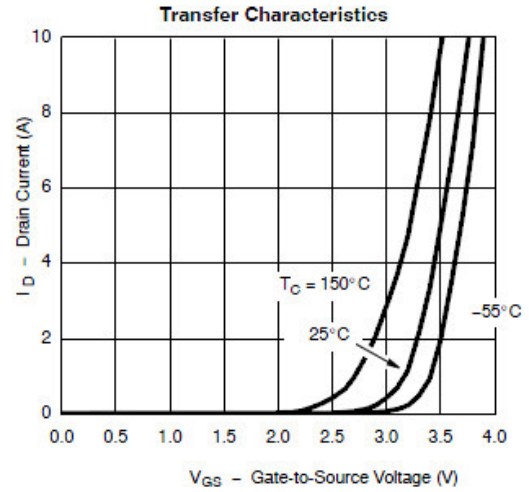
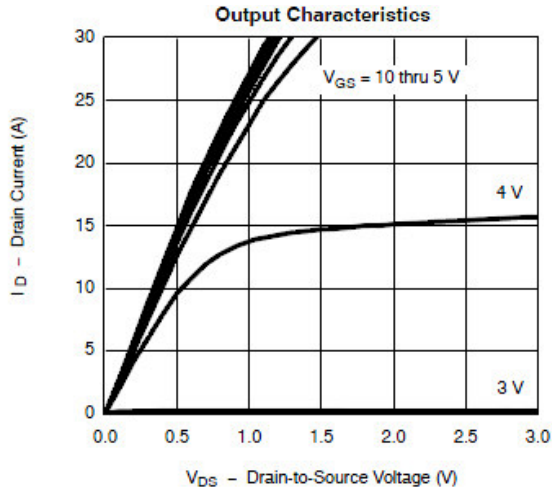



Typical Characteristics (N-Channel)

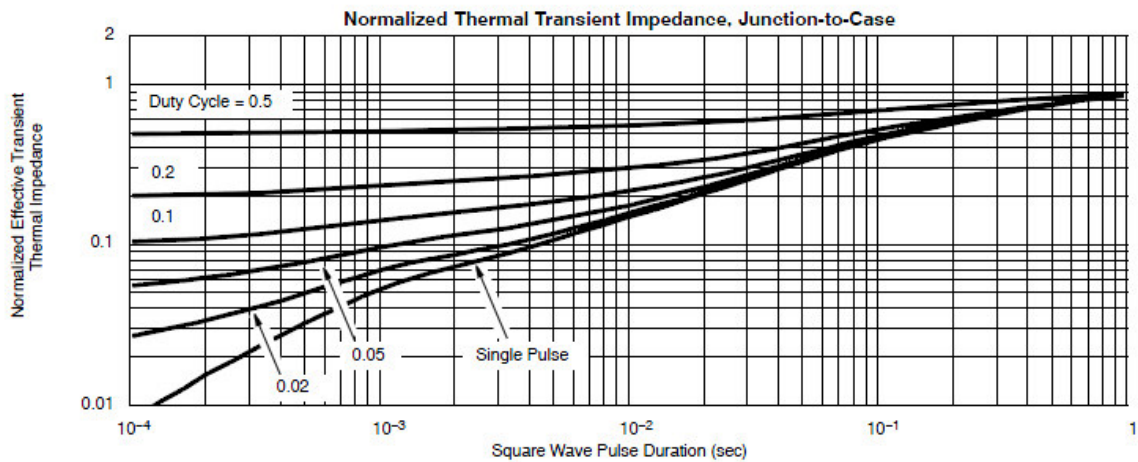
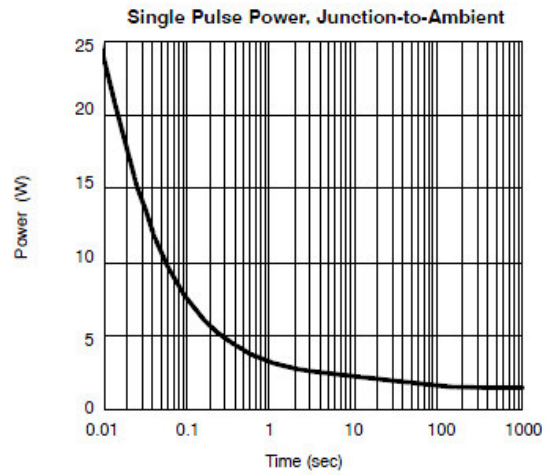
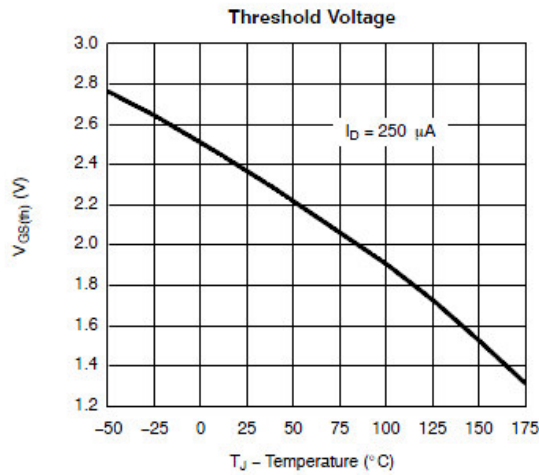
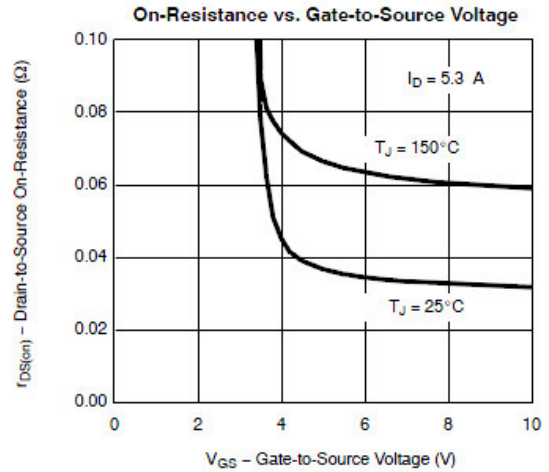
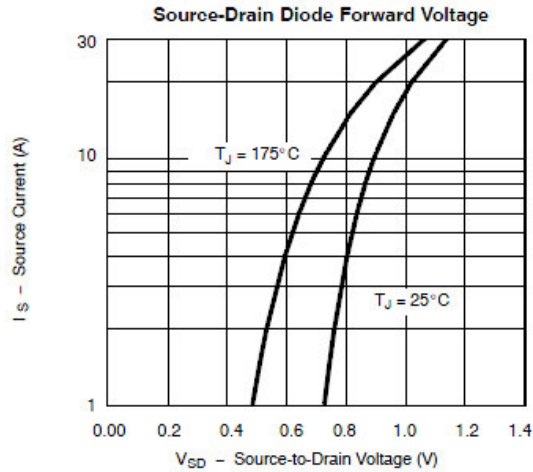



Typical Characteristics (P-Channel)

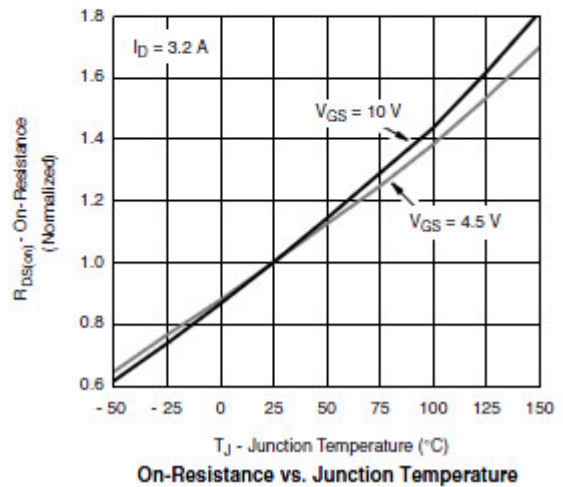
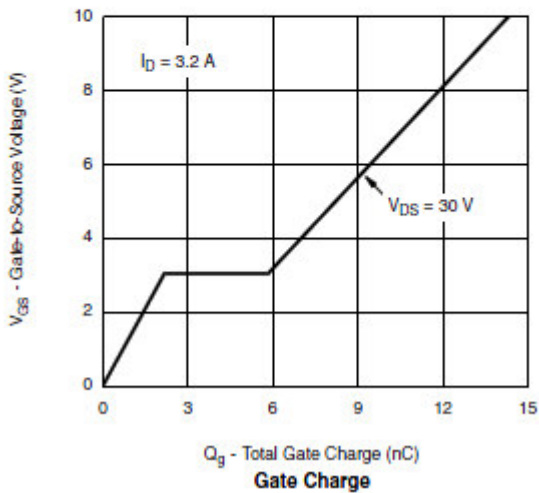
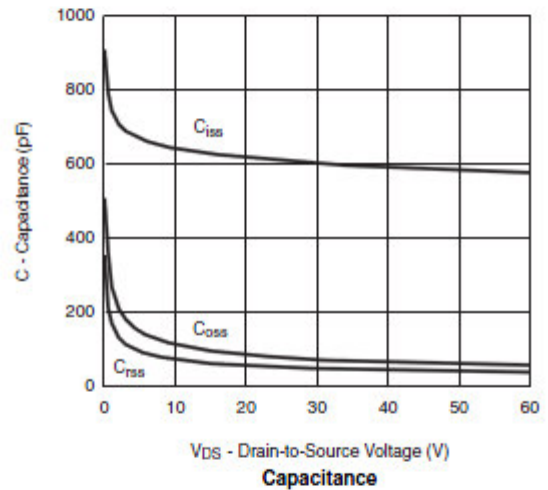
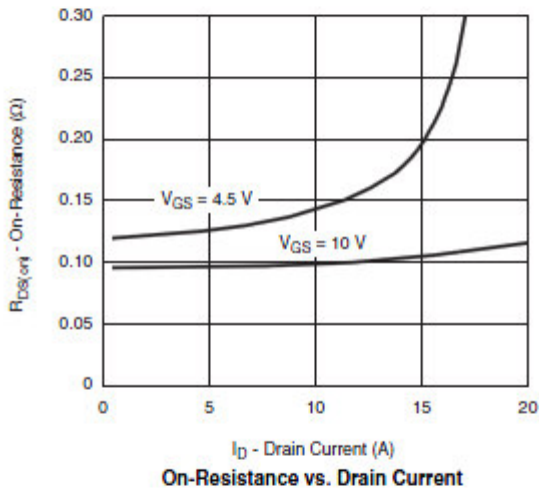
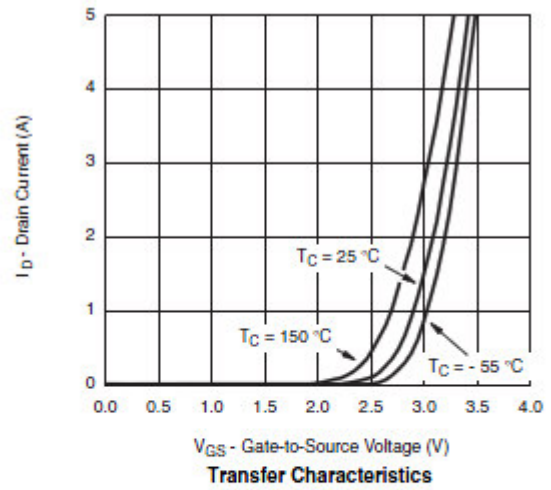
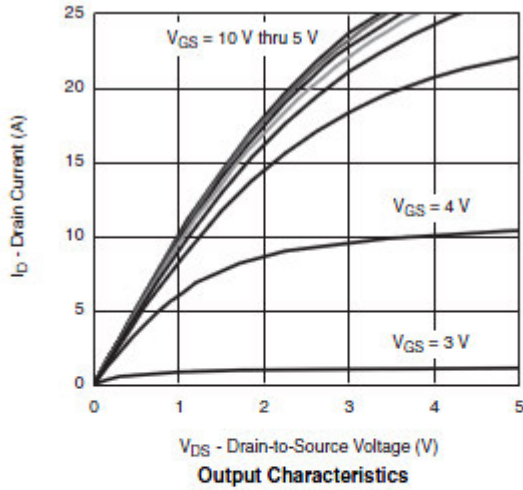



Typical Characteristics (P-Channel)

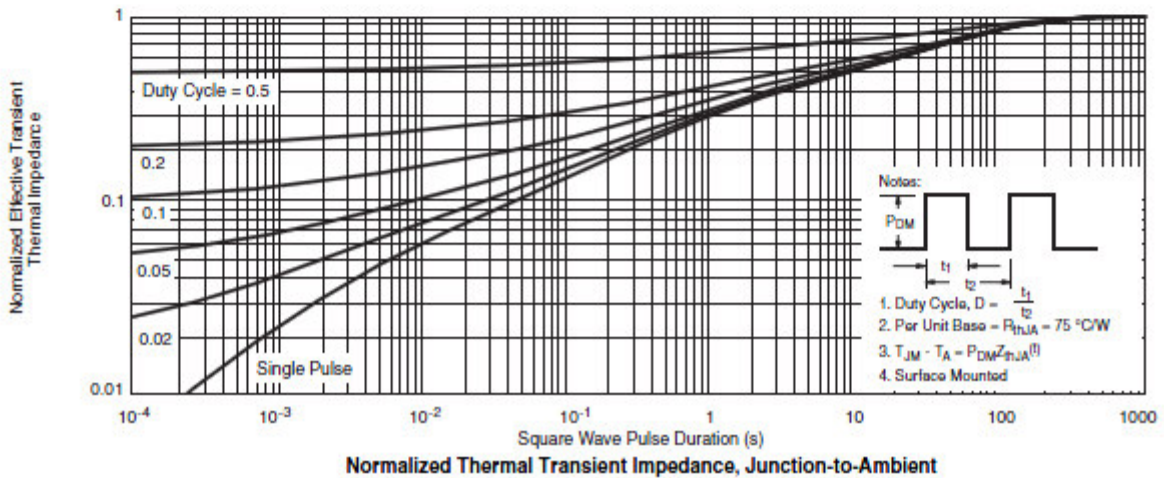
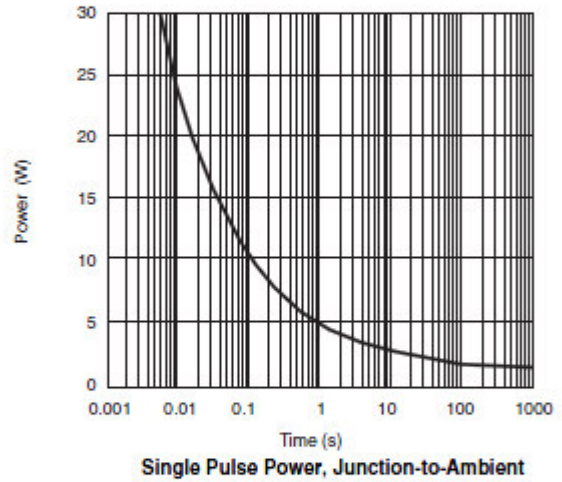
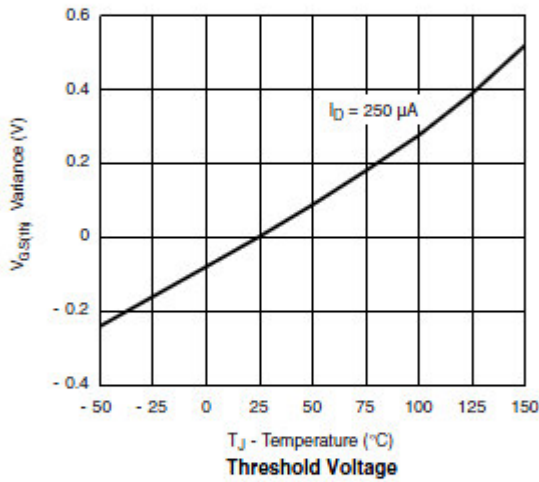
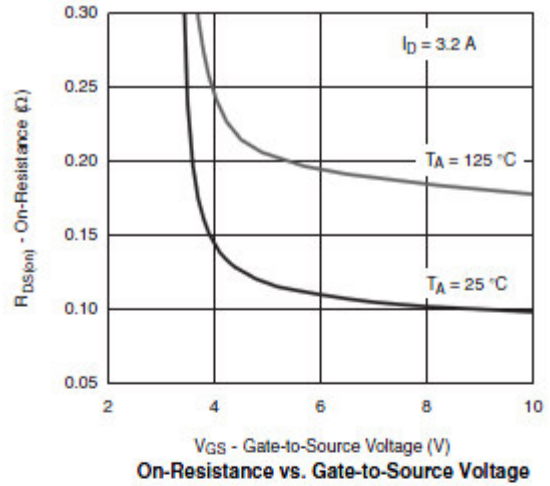
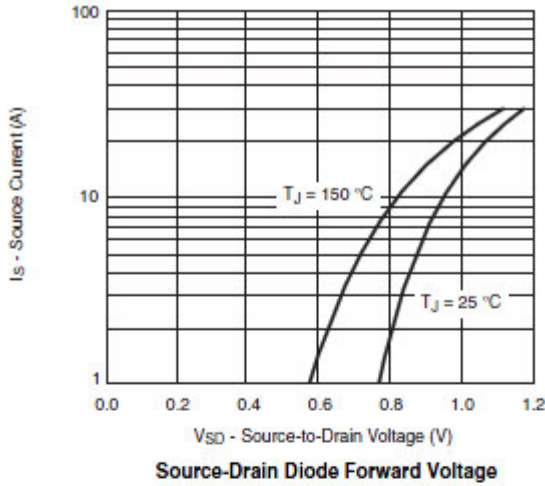



Typical Characteristics

Gate Charge Test Circuit & Waveform

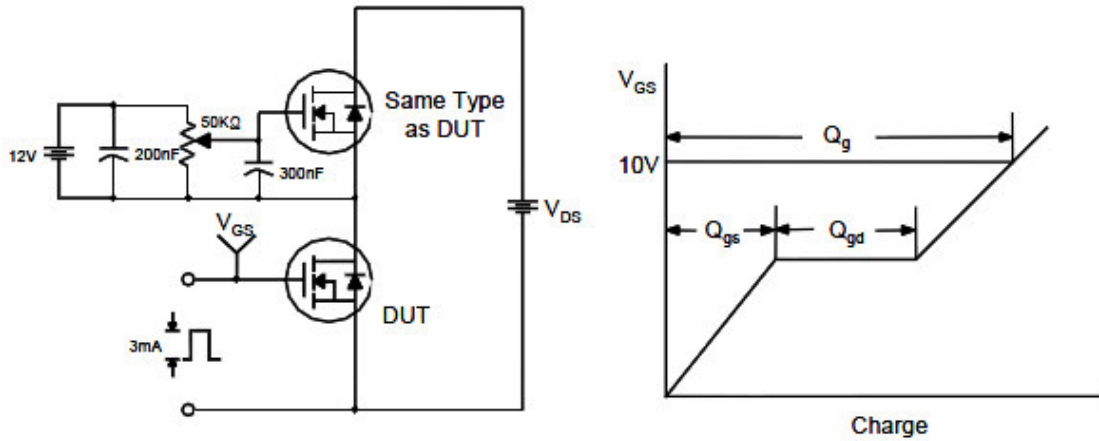

Resistive Switching Test Circuit & Waveforms

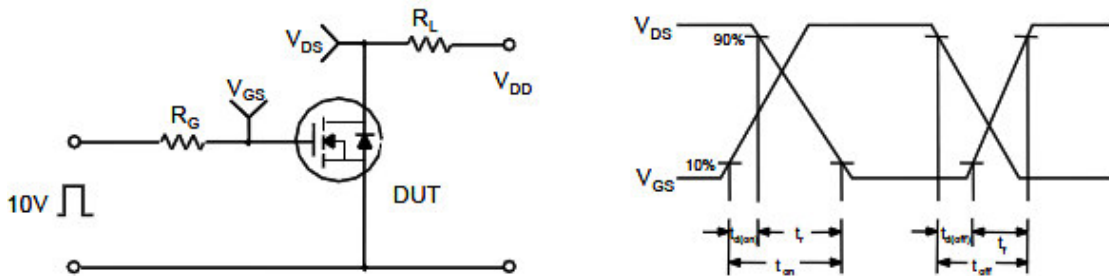

Unclamped Inductive Switching Test Circuit & Waveforms

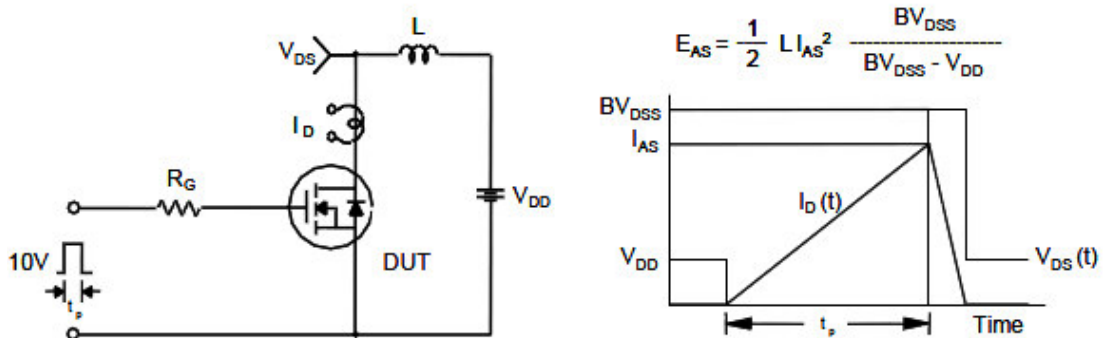



Package Information (TO-252-4L)

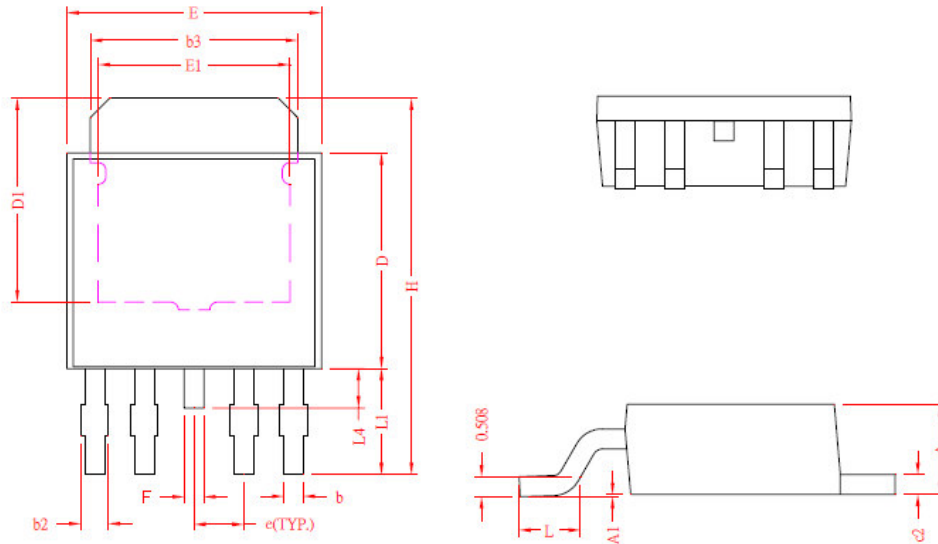

REF.	Millimeter		REF.	Millimeter	
	Min.	Max.		Min.	Max.
A	2.20	2.40	E	6.40	6.80
A1	0	0.15	E1	3.81	---
b	0.40	0.60	e	1.27 REF.	
b2	0.50	0.80	F	0.40	0.60
b3	5.20	5.50	H	9.40	10.20
c2	0.45	0.55	L	1.40	1.77
D	5.40	5.80	L1	2.40	3.00
D1	4.57	---	L4	0.80	1.20

©2010 Alfa-MOS Technology Corp.
 2F, No.80, Sec.1, Cheng Kung Rd., Nan Kang Dist., Taipei City 115, Taiwan (R.O.C.)
 Tel : 886 2) 2651 3928
 Fax : 886 2) 2786 8483
 ©http://www.alfa-mos.com