



**SPECIFICATION
FOR
LCD MODULE**

**MODULE NO: AFM320240B01-5.7N6WTH
VERSION NO.: V1.0**

Customer's Approval:

| |
|--|
| |
|--|

| | SIGNATURE | DATE |
|-------------|-----------|------|
| PREPARED BY | | |
| CHECKED BY | | |
| APPROVED BY | | |

REVISION RECORD

| REV NO. | REV DATE | CONTENTS | REMARKS |
|----------------|-----------------|-----------------|----------------|
| V0.1 | 2013-10-18 | First release | Preliminary |
| | | | |
| | | | |
| | | | |
| | | | |
| | | | |
| | | | |
| | | | |
| | | | |
| | | | |
| | | | |
| | | | |
| | | | |
| | | | |
| | | | |
| | | | |
| | | | |
| | | | |
| | | | |
| | | | |
| | | | |
| | | | |
| | | | |

CONTENTS

| | |
|---|-----------|
| ■ GENERAL INFORMATION..... | 4 |
| ■ ABSOLUTE MAXIMUM RATINGS..... | 4 |
| ■ ELECTRICAL CHARACTERISTICS..... | 4 |
| ■ BACKLIGHT CHARACTERISTICS..... | 4 |
| ■ EXTERNAL DIMENSIONS..... | 5 |
| ■ ELECTRO-OPTICAL CHARACTERISTICS..... | 6 |
| ■ INTERFACE DESCRIPTION..... | 8 |
| ■ AC CHARACTERISTICS..... | 9 |
| ■ POWER SEQUENCE..... | 10 |
| ■ REFERENCE APPLICATION CIRCUIT..... | 11 |
| ■ RELIABILITY TEST CONDITIONS..... | 12 |
| ■ INSPECTION CRITERION..... | 13 |

■ GENERAL INFORMATION

| Item of general information | Contents | Unit |
|-----------------------------|-------------------------------|-----------------|
| LCD size | 5.7 inch | / |
| LCD type | TFT/TRANSMISSIVE normal white | |
| View direction | 6 o'clock | |
| Resolution | 320*240 | |
| Module size (W × H×T) | 144.1(W)×104.6(H)×11.02(D) | mm ³ |
| Active area (W×H) | 115.2(H)×86.4(V) | mm ² |
| Pixel pitch (W × H) | 0.36(H)×0.36(V) | mm ² |
| Interface Type | 8080 interface | / |
| Input voltage | 3.3V~5V | V |
| Module Power consumption | TBD | mw |
| Backlight Type | White | / |

■ ABSOLUTE MAXIMUM RATINGS

| Parameter | Symbol | Min | Max | Unit |
|--------------------------|--------|------|---------------|------|
| Power supply voltage | VDD | -0.3 | +6.0 | V |
| Logic Signal Input Level | Vi | -0.3 | 3.6 | V |
| Operating temperature | Top | -30 | 80 | °C |
| Storage temperature | TST | -40 | 90 | °C |
| Humidity | RH | - | 90%(Max60 °C) | RH |

■ ELECTRICAL CHARACTERISTICS

DC CHARACTERISTICS

| Parameter | Symbol | Min | Typ | Max | Unit |
|-------------------------|--------|---------|-----|---------|------|
| Supply Voltage | VDD | 3.3 | - | 6 | V |
| Digital of I/O | DVDD | 2.56 | - | 3.6 | |
| Current of power supply | VDD | - | TBD | - | mA |
| Input voltage 'H' level | VIH | 0.7DVDD | - | DVDD | V |
| Input voltage 'L' level | VIL | 0 | - | 0.3DVDD | V |

Note:DVDD is the power supply for digital signals.

■ BACKLIGHT CHARACTERISTICS

| Item of backlight characteristics | Symbol | Min. | Typ. | Max. | Unit | Condition |
|-----------------------------------|--------|--------|------|------|------|-----------|
| LED life time | | 50,000 | - | - | Hour | Note 2 |

Note 1: The LED Supply Voltage is defined by the number of LED at Ta=25°C and IL =20mA for each LED.

Note 2: The “LED life time” is defined as the module brightness decrease to 50% original brightness at Ta=25°C and IL =20mA. The LED lifetime could be decreased if operating IL is larger than 160 mA.

EXTERNAL DIMENSIONS

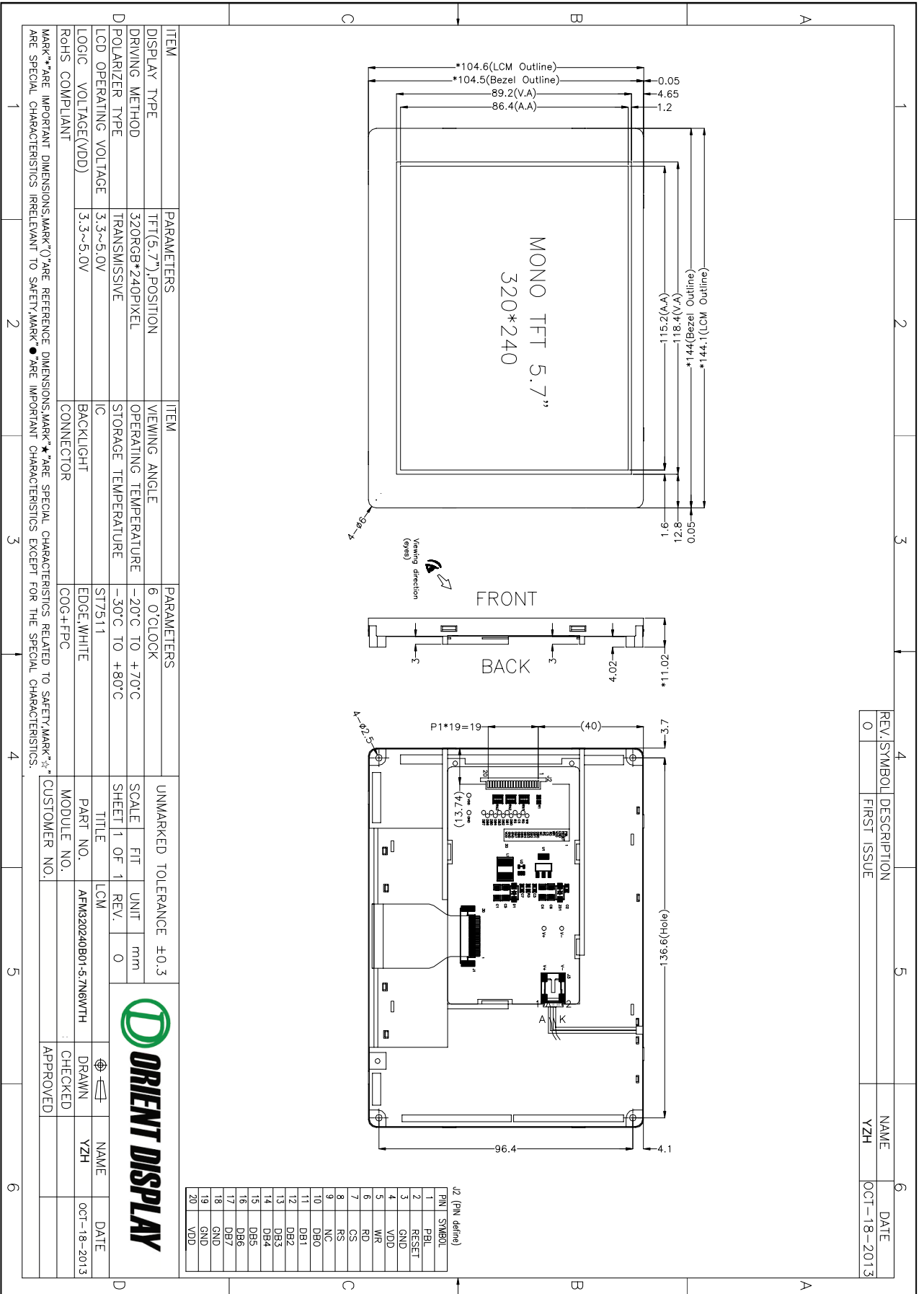

| ITEM | PARAMETERS | ITEM | PARAMETERS |
|-----------------------|--------------------|-----------------------|----------------|
| DISPLAY TYPE | TFT(5.7") POSITION | VIEWING ANGLE | 6.0°CLOCK |
| DRIVING METHOD | 320RGB*240PIXEL | OPERATING TEMPERATURE | -20°C TO +70°C |
| POLARIZER TYPE | TRANSMISSIVE | STORAGE TEMPERATURE | -30°C TO +80°C |
| LCD OPERATING VOLTAGE | 3.3~5.0V | IC | ST7511 |
| LOGIC VOLTAGE(VDD) | 3.3~5.0V | BACKLIGHT | EDGE WHITE |
| RoHS COMPLIANT | | CONNECTOR | COG+FPC |



| UNMARKED TOLERANCE | SCALE | FIT | UNIT | REVISION | TITLE | PART NO. | MODULE NO. | CUSTOMER NO. |
|--------------------|-------|-----|------|----------|-------|-----------------------|------------|--------------|
| ±0.3 | 1:1 | | mm | 0 | LCM | AFM320240B01-5-7N6WTH | | |

MARK**ARE IMPORTANT DIMENSIONS.MARK(*)ARE REFERENCE DIMENSIONS.MARK(*)ARE SPECIAL CHARACTERISTICS RELATED TO SAFETY.MARK(*)ARE SPECIAL CHARACTERISTICS IRRELEVANT TO SAFETY.MARK(*)ARE IMPORTANT CHARACTERISTICS EXCEPT FOR THE SPECIAL CHARACTERISTICS.

| REV. SYMBOL | DESCRIPTION | NAME | DATE |
|-------------|-------------|------|-------------|
| 0 | FIRST ISSUE | YZH | OCT-18-2013 |

■ ELECTRO-OPTICAL CHARACTERISTICS

| Item of electro-optical characteristics | Symbol | Condition | Min | Typ | Max | Unit | Remark | Note |
|---|---------|-------------------------|-------|-------|-------|-------------------|--------|------|
| Response time | Tr+ Tf | | – | 25 | 50 | ms | Fig.1 | 4 |
| Contrast ratio | Cr | | 400 | 500 | – | --- | FIG 2. | 1 |
| Luminance uniformity | δ WHITE | | 60 | 75 | – | % | FIG 2. | 3 |
| Surface Luminance | Lv | | 500 | 600 | – | cd/m ² | FIG 2. | 2 |
| Viewing angle range | θ | ∅ = 90° | 45 | 50 | – | deg | FIG 3. | 6 |
| | | ∅ = 270° | 50 | 60 | – | deg | FIG 3. | |
| | | ∅ = 0° | 50 | 60 | – | deg | FIG 3. | |
| | | ∅ = 180° | 50 | 60 | – | deg | FIG 3. | |
| CIE (x, y) chromaticity | Red x | θ=0° ∅=0° Ta=25°C | - | - | - | - | FIG 2. | 5 |
| | Red y | | - | - | - | - | | |
| | Green x | | - | - | - | - | | |
| | Green y | | - | - | - | - | | |
| | Blue x | | - | - | - | - | | |
| | Blue y | | - | - | - | - | | |
| | White x | | 0.294 | 0.304 | 0.314 | - | | |
| | White y | | 0.329 | 0.339 | 0.349 | - | | |

Note1. Contrast Ratio(CR) is defined mathematically by the following formula. For more information see FIG 2.:

$$\text{Contrast Ratio} = \frac{\text{Average Surface Luminance with all white pixels (P1, P2, P3, P4, P5)}}{\text{Average Surface Luminance with all black pixels (P1, P2, P3, P4, P5)}}$$

Note2. Surface luminance is the LCD surface from the surface with all pixels displaying white. For more information see FIG 2.

$$L_v = \text{Average Surface Luminance with all white pixels (P1, P2, P3, P4, P5)}$$

Note3. The uniformity in surface luminance (δ WHITE) is determined by measuring luminance at each test position 1 through 5, and then dividing the maximum luminance of 5 points luminance by minimum luminance of 5 points luminance. For more information see FIG 2.

$$\delta \text{ WHITE} = \frac{\text{Minimum Surface Luminance with all white pixels (P1, P2, P3, P4, P5)}}{\text{Maximum Surface Luminance with all white pixels (P1, P2, P3, P4, P5)}}$$

Note4. Response time is the time required for the display to transition from White to black(Rise Time, Tr) and from black to white(Decay Time, Tf). For additional information see FIG 1..

Note5. CIE (x, y) chromaticity, The x,y value is determined by screen active area position NO.5 For more information see FIG 2.

Note6. Viewing angle is the angle at which the contrast ratio is greater than 2. For TFT module the contrast ratio is greater than 10. The angles are determined for the horizontal or x axis and the vertical or y axis with respect to the z axis which is normal to the LCD surface. For more information see FIG 3.

Note7. For Viewing angle and response time testing, the testing data is base on Autronic-Melchers's ConoScope. Series Instruments. For contrast ratio, Surface Luminance, Luminance uniformity and CIE, the testing data is base on TOPCON's BM-5 photo detector or compatible.

Note8. For TFT module, Gray scale reverse occurs in the direction of panel viewing angle

FIG.1. The definition of Response Time

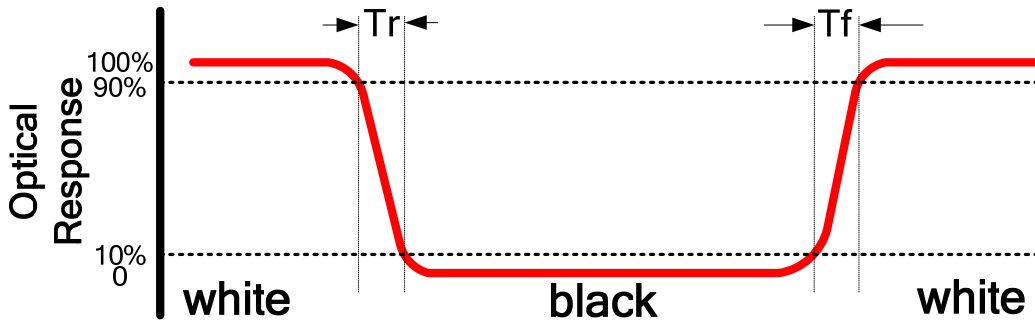

FIG.2. Measuring method for Contrast ratio, surface luminance, Luminance uniformity, CIE (x, y) chromaticity

A : 5 mm
 B : 5 mm
 H, V : Active Area
 Light spot size $\varnothing=5\text{mm}$, 500mm distance from the LCD surface to detector lens
 measurement instrument is TOPCON's luminance meter BM-5

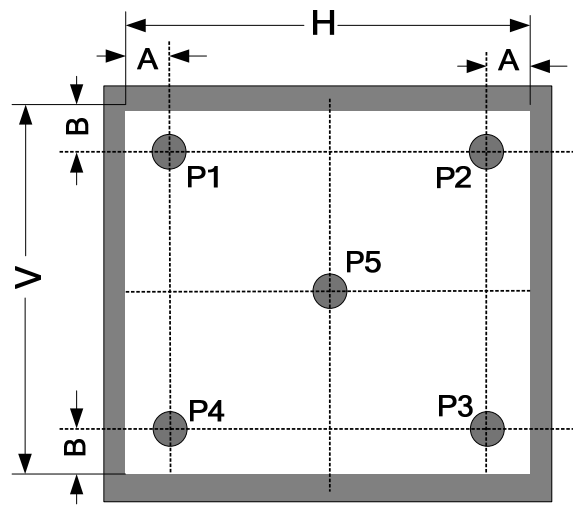
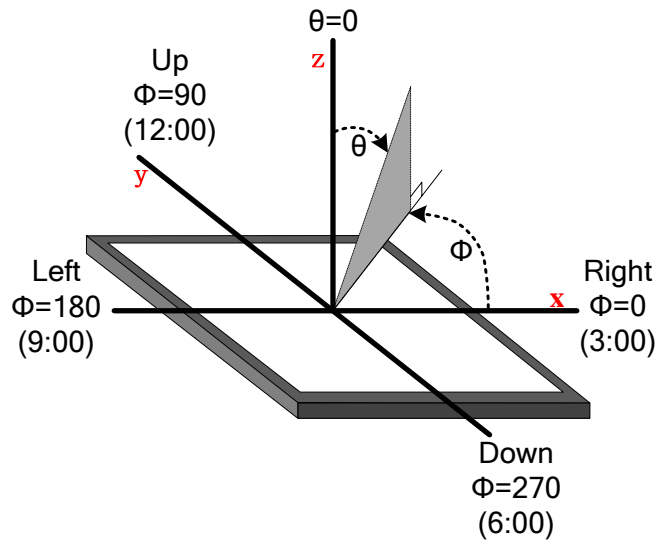

FIG.3. The definition of viewing angle



■ INTERFACE DESCRIPTION

LCM Interface description

| Interface NO. | NAME | I/O or connect to | DESCRIPTION |
|----------------------|-------------|--------------------------|---------------------------------|
| 1 | PBL | P | Power enable signal /High valid |
| 2 | RESET | I | Reset signal of the LCM |
| 3 | GND | P | Ground |
| 4 | VDD | P | Power of LCM 3.3V-5V |
| 5 | WR | I | Write signal of 8080 interface |
| 6 | RD | I | Read signal of 8080 interface |
| 7 | CS | I | Chip selection |
| 8 | RS | I | Command or date selection |
| 9 | NC | / | / |
| 10-17 | DB0-DB7 | I/O | Databus |
| 18 | GND | P | Ground |
| 19 | GND | P | Ground |
| 20 | VDD | P | Power of LCM 3.3V-5V |

■ AC CHARACTERISTICS

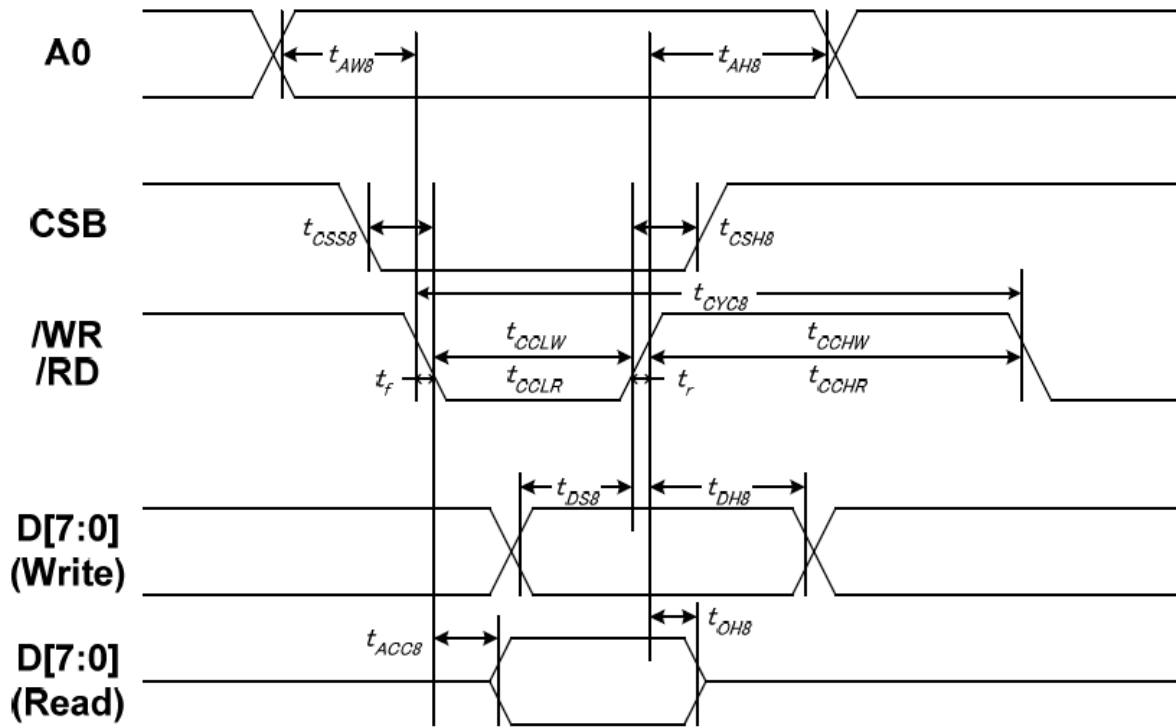

AGND = PGND = DGND = 0V, VDDA = VDDP = VDDI = 3.0 ~ 5.0V, Ta = 25°C

| Item | Signal | Symbol | Condition | Min. | Max. | Unit |
|---------------------------|--------|--------|-------------|------|------|------|
| Address setup time | A0 | tAW8 | | 10 | — | ns |
| Address hold time | | tAH8 | | 0 | — | |
| System cycle time | /WR | tCYC8 | | 1100 | — | |
| /WR L pulse width (WRITE) | | tCCLW | | 500 | — | |
| /WR H pulse width (WRITE) | | tCCHW | | 500 | — | |
| /RD L pulse width (READ) | | /RD | tCCLR | | 950 | |
| /RD H pulse width (READ) | tCCHR | | | 500 | — | |
| CSB setup time | CSB | tCSS8 | | 100 | — | |
| CSB hold time | | tCSH8 | | 100 | — | |
| WRITE Data setup time | D[7:0] | tDS8 | | 200 | — | |
| WRITE Data hold time | | tDH8 | | 50 | — | |
| READ access time | | tACC8 | CL = 100 pF | — | 950 | |
| READ Output disable time | | tOH8 | CL = 100 pF | 5 | 200 | |

■ POWER SEQUENCE

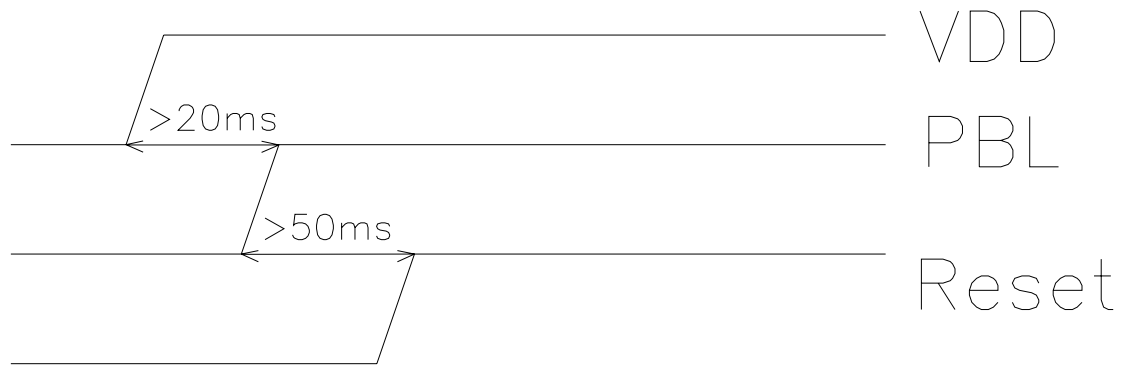

■ REFERENCE APPLICATION CIRCUIT

Please consult our technical department for detail information.

■ RELIABILITY TEST CONDITIONS

| No. | Test Item | Test Condition | Inspection after test |
|-----|----------------------------|--|--|
| 1 | High Temperature Storage | 80±2°C/240 hours | Inspection after 2~4hours storage at room temperature, the sample shall be free from defects: 1.Air bubble in the LCD; 2.Sealleak; 3.Non-display; 4.missing segments; 5.Glass crack; 6.Current Idd is twice higher than initial value. |
| 2 | Low Temperature Storage | -30±2°C/240 hours | |
| 3 | High Temperature Operating | 70±2°C/120 hours | |
| 4 | Low Temperature Operating | -20±2°C/120 hours | |
| 5 | Temperature Cycle | -20±2°C~25~70±2°C×10cycles (30min.) (5min.) (30min.) | |
| 6 | Damp Proof Test | 50°C±5°C×90%RH/120 hours | |
| 7 | Vibration Test | Frequency: 10Hz~55Hz~10Hz Amplitude: 1.5mm, X, Y, Z direction for total 3hours (Packing condition) | |
| 8 | Dropping test | Drop to the ground from 1m height, one time, every side of carton. (Packing condition) | |
| 9 | ESD test | Voltage:±8KV R: 330Ω C: 150pF Air discharge, 10time | |

Remark:

- 1.The test samples should be applied to only one test item.
- 2.Sample size for each test item is 5~10pcs.
- 3.For Damp Proof Test, Pure water(Resistance>10MΩ) should be used.
- 4.In case of malfunction defect caused by ESD damage, if it would be recovered to normal state after resetting, it would be judged as a good part.
- 5.EL evaluation should be excepted from reliability test with humidity and temperature: Some defects such as black spot/blemish can happen by natural chemical reaction with humidity and Fluorescence EL has.
- 6.Failure Judgment Criterion: Basic Specification, Electrical Characteristic, Mechanical Characteristic, Optical Characteristic.

■ INSPECTION CRITERION

This specification is made to be used as the standard acceptance/rejection criteria for Normal LCM Product.

1 Sample plan

Sampling plan according to GB/T2828.1-2003/ISO 2859-1 : 1999 and ANSI/ASQC Z1.4-1993, normal level 2 and based on:

Major defect: AQL 0.65

Minor defect: AQL 1.5

2. Inspection condition

● Viewing distance for cosmetic inspection is about 30cm with bare eyes, and under an environment of 20~40W light intensity, all directions for inspecting the sample should be within 45° against perpendicular line. (Normal temperature 20~25°C and normal humidity 60±15%RH).

● Driving voltage

The Vop value from which the most optimal contrast can be obtained near the specified Vop in the specification (Within ±0.5V of the typical value at 25°C.).

3. Definition of inspection zone in LCD.

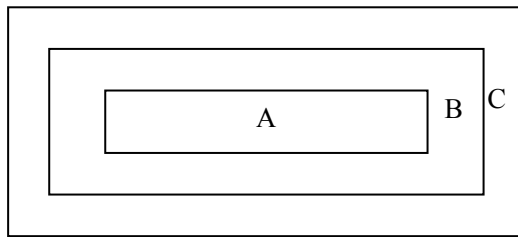

Zone A: character/Digit area

Zone B: viewing area except Zone A (ZoneA+ZoneB=minimum Viewing area)

Zone C: Outside viewing area (invisible area after assembly in customer's product)

Fig.1 Inspection zones in an LCD.

Note: As a general rule, visual defects in Zone C are permissible, when it is no trouble for quality and assembly of customer's product.

4. Inspection Standard

4.1 Major Defect

| Item No | Items to be inspected | Inspection Standard | Classification of defects |
|---------|------------------------|---|---------------------------|
| 4.1.1 | All functional defects | 1) No display 2) Display abnormally 3) Missing vertical, horizontal segment 4) Short circuit 5) Back-light no lighting, flickering and abnormal lighting. | Major |
| 4.1.2 | Missing | Missing component | |
| 4.1.3 | Outline dimension | Overall outline dimension beyond the drawing is not allowed. | |

4.2 Cosmetic Defect

4.2.1 Module Cosmetic Criteria

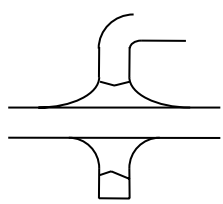
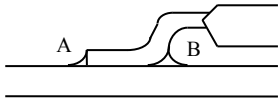
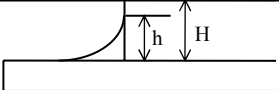
| No. | Item | Judgement Criterion | Partition |
|-----|---------------------------------------|---|-------------------------|
| 1 | Difference in Spec. | None allowed | Major |
| 2 | Pattern peeling | No substrate pattern peeling and floating | Major |
| 3 | Soldering defects | No soldering missing No soldering bridge No cold soldering | Major Major Minor |
| 4 | Resist flaw on Printed Circuit Boards | visible copper foil ($\varnothing 0.5\text{mm}$ or more) on substrate pattern | Minor |
| 5 | Accretion of metallic Foreign matter | No accretion of metallic foreign matters (Not exceed $\varnothing 0.2\text{mm}$) | Minor Minor |
| 6 | Stain | No stain to spoil cosmetic badly | Minor |
| 7 | Plate discoloring | No plate fading, rusting and discoloring | Minor |
| 8 | Solder amount | a. Soldering side of PCB Solder to form a 'Filet' all around the lead. Solder should not hide the lead form perfectly. (too much) b. Components side (In case of 'Through Hole PCB')  Solder to reach the Components side of PCB. | Minor |
| | 2. Flat packages | Either 'Toe' (A) or 'Seal' (B) of the lead to be covered by 'Filet'.  Lead form to be assume over solder. | Minor |
| | 3. Chips | $(3/2) H \geq h \geq (1/2) H$  | Minor |

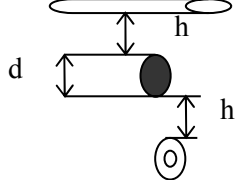
| | | | | |
|---|---------------------------|--|--|-------|
| 9 | Solder ball/Solder splash | <p>a. The spacing between solder ball and the conductor or solder pad $h \geq 0.13\text{mm}$. The diameter of solder ball $d \leq 0.15\text{mm}$.</p> <p>b. The quantity of solder balls or solder Splashes isn't beyond 5 in 600mm^2.</p> <p>c. Solder balls/Solder splashes do not violate minimum electrical clearance.</p> <p>d. Solder balls/Solder splashes must be entrapped/encapsulated Or attached to the metal surface.</p> <p>NOTE: Entrapped/encapsulated/attached is intended to mean that normal service environment of the product will not cause a solder ball to become dislodged.</p> |  | Minor |
| | | | | Minor |
| | | | | Major |
| | | | | Minor |

4.2.2Cosmetic Criteria (Non-Operating)

| No. | Defect | Judgment Criterion | Partition | | | | | | | | | | |
|--------------------|----------------------|--|-------------------------------|-------------------------------|--------------|-----------|--------------------|---|--------------------|---|-----------|---|-------|
| 1 | Spots | In accordance with <i>Screen Cosmetic Criteria (Operating) No.1.</i> | Minor | | | | | | | | | | |
| 2 | Lines | In accordance with <i>Screen Cosmetic Criteria (Operating) No.2.</i> | Minor | | | | | | | | | | |
| 3 | Bubbles in polarizer | <table border="1"> <thead> <tr> <th>Size : d mm</th> <th>Acceptable Qty in active area</th> </tr> </thead> <tbody> <tr> <td>$d \leq 0.3$</td> <td>Disregard</td> </tr> <tr> <td>$0.3 < d \leq 1.0$</td> <td>3</td> </tr> <tr> <td>$1.0 < d \leq 1.5$</td> <td>1</td> </tr> <tr> <td>$1.5 < d$</td> <td>0</td> </tr> </tbody> </table> | Size : d mm | Acceptable Qty in active area | $d \leq 0.3$ | Disregard | $0.3 < d \leq 1.0$ | 3 | $1.0 < d \leq 1.5$ | 1 | $1.5 < d$ | 0 | Minor |
| | | Size : d mm | Acceptable Qty in active area | | | | | | | | | | |
| | | $d \leq 0.3$ | Disregard | | | | | | | | | | |
| | | $0.3 < d \leq 1.0$ | 3 | | | | | | | | | | |
| $1.0 < d \leq 1.5$ | 1 | | | | | | | | | | | | |
| $1.5 < d$ | 0 | | | | | | | | | | | | |
| 4 | Scratch | In accordance with spots and lines operating cosmetic criteria. When the light reflects on the panel surface, the scratches are not to be remarkable. | Minor | | | | | | | | | | |
| 5 | Allowable density | Above defects should be separated more than 30mm each other. | Minor | | | | | | | | | | |
| 6 | Coloration | Not to be noticeable coloration in the viewing area of the LCD panels. Back-lit type should be judged with back-lit on state only. | Minor | | | | | | | | | | |
| 7 | Contamination | Not to be noticeable. | Minor | | | | | | | | | | |

4.2.3 Cosmetic Criteria (Operating)

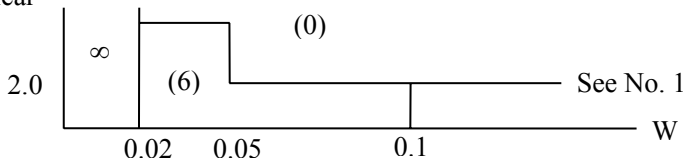
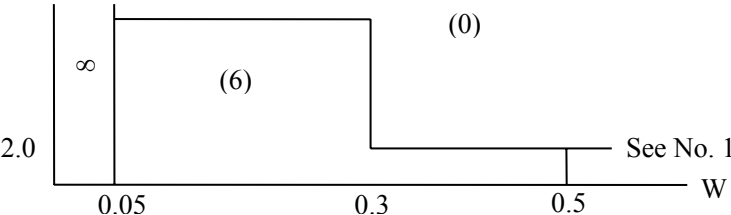
| No. | Defect | Judgment Criterion | Partition | | | | | | | | | | | | | | | | | | | | | | | | | | | | | | | | | | | | | | | | | | | | |
|-----------------|---------------|--|-----------|-------------|-------------------------------|-----------------|---------|-----------|---------------|---|---------------|---|---------|---|-----------------|---------|-----------|---------------|----|---------------|---|---------|---|----------|-------------|-------------------------------|-----------------|---------|-----------|---------------|---|---------------|---|---------|---|-----------------|---------|-----------|---------------|----|---------------|---|---------------|---|---------|---|-------|
| 1 | Spots | <p>A) Clear</p> <table border="1" data-bbox="443 376 1278 707"> <thead> <tr> <th>Lcd size</th> <th>Size : d mm</th> <th>Acceptable Qty in active area</th> </tr> </thead> <tbody> <tr> <td rowspan="4">Lcd size ≤ 8.0'</td> <td>d ≤ 0.1</td> <td>Disregard</td> </tr> <tr> <td>0.1 < d ≤ 0.2</td> <td>6</td> </tr> <tr> <td>0.2 < d ≤ 0.3</td> <td>2</td> </tr> <tr> <td>0.3 < d</td> <td>0</td> </tr> <tr> <td rowspan="4">Lcd size > 8.0'</td> <td>d ≤ 0.1</td> <td>Disregard</td> </tr> <tr> <td>0.1 < d ≤ 0.3</td> <td>10</td> </tr> <tr> <td>0.3 < d ≤ 0.5</td> <td>5</td> </tr> <tr> <td>0.5 < d</td> <td>0</td> </tr> </tbody> </table> <p>Note : Including pin holes and defective dots which must be within one pixel size; Total defective point shall not exceed 6 pcs no more than 8 inch LCD and 10PCS for more than 8 inch LCD.</p> <p>B) Unclear</p> <table border="1" data-bbox="443 898 1278 1283"> <thead> <tr> <th>Lcd size</th> <th>Size : d mm</th> <th>Acceptable Qty in active area</th> </tr> </thead> <tbody> <tr> <td rowspan="4">Lcd size ≤ 8.0'</td> <td>d ≤ 0.2</td> <td>Disregard</td> </tr> <tr> <td>0.2 < d ≤ 0.5</td> <td>6</td> </tr> <tr> <td>0.5 < d ≤ 0.7</td> <td>2</td> </tr> <tr> <td>0.7 < d</td> <td>0</td> </tr> <tr> <td rowspan="5">Lcd size > 8.0'</td> <td>d ≤ 0.2</td> <td>Disregard</td> </tr> <tr> <td>0.2 < d ≤ 0.5</td> <td>10</td> </tr> <tr> <td>0.5 < d ≤ 0.7</td> <td>3</td> </tr> <tr> <td>0.7 < d ≤ 1.0</td> <td>1</td> </tr> <tr> <td>1.0 < d</td> <td>0</td> </tr> </tbody> </table> <p>Note : Total defective point shall not exceed 6 pcs for no more than 8 inch LCD and 10PCS for more than 8 inch LCD.</p> | Lcd size | Size : d mm | Acceptable Qty in active area | Lcd size ≤ 8.0' | d ≤ 0.1 | Disregard | 0.1 < d ≤ 0.2 | 6 | 0.2 < d ≤ 0.3 | 2 | 0.3 < d | 0 | Lcd size > 8.0' | d ≤ 0.1 | Disregard | 0.1 < d ≤ 0.3 | 10 | 0.3 < d ≤ 0.5 | 5 | 0.5 < d | 0 | Lcd size | Size : d mm | Acceptable Qty in active area | Lcd size ≤ 8.0' | d ≤ 0.2 | Disregard | 0.2 < d ≤ 0.5 | 6 | 0.5 < d ≤ 0.7 | 2 | 0.7 < d | 0 | Lcd size > 8.0' | d ≤ 0.2 | Disregard | 0.2 < d ≤ 0.5 | 10 | 0.5 < d ≤ 0.7 | 3 | 0.7 < d ≤ 1.0 | 1 | 1.0 < d | 0 | Minor |
| Lcd size | Size : d mm | Acceptable Qty in active area | | | | | | | | | | | | | | | | | | | | | | | | | | | | | | | | | | | | | | | | | | | | | |
| Lcd size ≤ 8.0' | d ≤ 0.1 | Disregard | | | | | | | | | | | | | | | | | | | | | | | | | | | | | | | | | | | | | | | | | | | | | |
| | 0.1 < d ≤ 0.2 | 6 | | | | | | | | | | | | | | | | | | | | | | | | | | | | | | | | | | | | | | | | | | | | | |
| | 0.2 < d ≤ 0.3 | 2 | | | | | | | | | | | | | | | | | | | | | | | | | | | | | | | | | | | | | | | | | | | | | |
| | 0.3 < d | 0 | | | | | | | | | | | | | | | | | | | | | | | | | | | | | | | | | | | | | | | | | | | | | |
| Lcd size > 8.0' | d ≤ 0.1 | Disregard | | | | | | | | | | | | | | | | | | | | | | | | | | | | | | | | | | | | | | | | | | | | | |
| | 0.1 < d ≤ 0.3 | 10 | | | | | | | | | | | | | | | | | | | | | | | | | | | | | | | | | | | | | | | | | | | | | |
| | 0.3 < d ≤ 0.5 | 5 | | | | | | | | | | | | | | | | | | | | | | | | | | | | | | | | | | | | | | | | | | | | | |
| | 0.5 < d | 0 | | | | | | | | | | | | | | | | | | | | | | | | | | | | | | | | | | | | | | | | | | | | | |
| Lcd size | Size : d mm | Acceptable Qty in active area | | | | | | | | | | | | | | | | | | | | | | | | | | | | | | | | | | | | | | | | | | | | | |
| Lcd size ≤ 8.0' | d ≤ 0.2 | Disregard | | | | | | | | | | | | | | | | | | | | | | | | | | | | | | | | | | | | | | | | | | | | | |
| | 0.2 < d ≤ 0.5 | 6 | | | | | | | | | | | | | | | | | | | | | | | | | | | | | | | | | | | | | | | | | | | | | |
| | 0.5 < d ≤ 0.7 | 2 | | | | | | | | | | | | | | | | | | | | | | | | | | | | | | | | | | | | | | | | | | | | | |
| | 0.7 < d | 0 | | | | | | | | | | | | | | | | | | | | | | | | | | | | | | | | | | | | | | | | | | | | | |
| Lcd size > 8.0' | d ≤ 0.2 | Disregard | | | | | | | | | | | | | | | | | | | | | | | | | | | | | | | | | | | | | | | | | | | | | |
| | 0.2 < d ≤ 0.5 | 10 | | | | | | | | | | | | | | | | | | | | | | | | | | | | | | | | | | | | | | | | | | | | | |
| | 0.5 < d ≤ 0.7 | 3 | | | | | | | | | | | | | | | | | | | | | | | | | | | | | | | | | | | | | | | | | | | | | |
| | 0.7 < d ≤ 1.0 | 1 | | | | | | | | | | | | | | | | | | | | | | | | | | | | | | | | | | | | | | | | | | | | | |
| | 1.0 < d | 0 | | | | | | | | | | | | | | | | | | | | | | | | | | | | | | | | | | | | | | | | | | | | | |
| 2 | Lines | <p>A) Clear</p>  <p>Note : () - Acceptable Qty in active area L - Length (mm) W - Width (mm) ∞ - Disregard</p> <p>B) Unclear</p>  <p>'Clear' = The shade and size are not changed by V_{op}. 'Unclear' = The shade and size are changed by V_{op}.</p> | Minor | | | | | | | | | | | | | | | | | | | | | | | | | | | | | | | | | | | | | | | | | | | | |

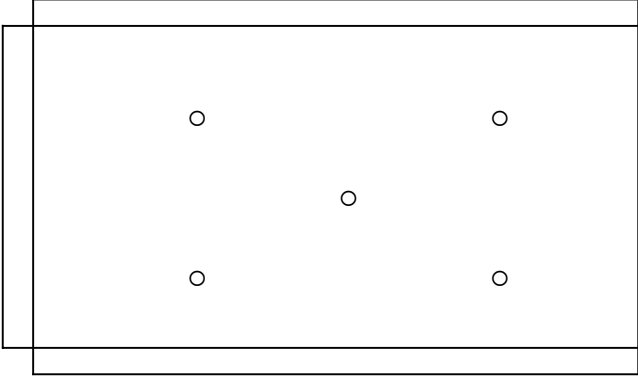
| | | | |
|---|--|---|-------|
| 3 | Rubbing line | Not to be noticeable. | Minor |
| 4 | Allowable density | Above defects should be separated more than 10mm each other. | Minor |
| 5 | Rainbow | Not to be noticeable. | Minor |
| 6 | Dot size | To be 95% ~ 105% of the dot size (Typ.) in drawing. Partial defects of each dot (ex. pin-hole) should be treated as 'Spot'. (see <i>Screen Cosmetic Criteria (Operating) No.1</i>) | Minor |
| 7 | Uneven brightness (only back-lit type module) | <p>Uneven brightness must be $B_{MAX} / B_{MIN} \leq 2$</p> <p>- B_{MAX} : Max. value by measure in 5 points - B_{MIN} : Min. value by measure in 5 points</p> <p>Divide active area into 4 vertically and horizontally. Measure 5 points shown in the following figure.</p>  <p>○ : Measuring points</p> | Minor |

Note :

(1) Size : $d = (\text{long length} + \text{short length}) / 2$

(2) The limit samples for each item have priority.

(3) Complex defects are defined item by item, but if the numbers of defects are defined in above table, the total number should not exceed 10.

(4) In case of 'concentration', even the spots or the lines of 'disregarded' size should not allowed. Following three situations should be treated as 'concentration'.

- 7 or over defects in circle of $\varnothing 5\text{mm}$.

- 10 or over defects in circle of $\varnothing 10\text{mm}$.

- 20 or over defects in circle of $\varnothing 20\text{mm}$.