



General Description

AFN1012, N-Channel enhancement mode MOSFET, uses Advanced Trench Technology to provide excellent $R_{DS(ON)}$, low gate charge.

These devices are particularly suited for low voltage power management, such as smart phone and notebook computer, and low in-line power loss are needed in commercial industrial surface mount applications.

Features

- 20V/0.6A, $R_{DS(ON)}=360m\Omega@V_{GS}=4.5V$
- 20V/0.5A, $R_{DS(ON)}=420m\Omega@V_{GS}=2.5V$
- 20V/0.4A, $R_{DS(ON)}=560m\Omega@V_{GS}=1.8V$
- Low Offset (Error) Voltage
- Low-Voltage Operation
- High-Speed Circuits
- Low Battery Voltage Operation
- SOT-523 package design

Pin Description (SOT-523)

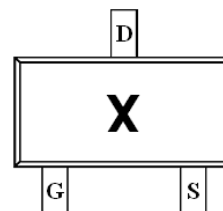
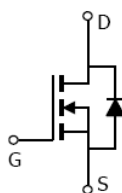
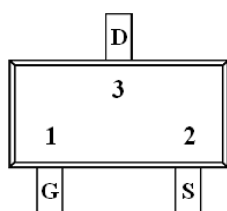

Application

- Drivers: Relays, Solenoids, Lamps, Hammers, Displays, Memories
- Battery Operated Systems
- Power Supply Converter Circuits
- Load/Power Switching Smart Phones, Pagers

Pin Define

Pin	Symbol	Description
1	G	Gate
2	S	Source
3	D	Drain

Ordering Information

Part Ordering No.	Part Marking	Package	Unit	Quantity
AFN1012S52RG	X	SOT-523	Tape & Reel	3000 EA

※ AFN1012S52RG : 7" Tape & Reel ; Pb- Free ; Halogen- Free



Absolute Maximum Ratings

(T_A=25°C Unless otherwise noted)

Parameter	Symbol	Typical	Unit
Drain-Source Voltage	V _{DSS}	20	V
Gate –Source Voltage	V _{GSS}	±12	V
Continuous Drain Current(T _J =150°C)	I _D	T _A =25°C	0.7
		T _A =70°C	0.4
Pulsed Drain Current	I _{DM}	1.0	A
Continuous Source Current(Diode Conduction)	I _S	0.3	A
Power Dissipation	P _D	T _A =25°C	0.27
		T _A =70°C	0.16
Operating Junction Temperature	T _J	-55/150	°C
Storage Temperature Range	T _{STG}	-55/150	°C

Electrical Characteristics

(T_A=25°C Unless otherwise noted)

Parameter	Symbol	Conditions	Min.	Typ	Max.	Unit
Static						
Drain-Source Breakdown Voltage	V _{(BR)DSS}	V _{GS} =0V, I _D =250uA	20			V
Gate Threshold Voltage	V _{GS(th)}	V _{DS} =V _{GS} , I _D =250uA	0.4		1.0	
Gate Leakage Current	I _{GSS}	V _{DS} =0V, V _{GS} =±12V			±100	nA
Zero Gate Voltage Drain Current	I _{DSS}	V _{DS} =20V, V _{GS} =0V			1	uA
		V _{DS} =20V, V _{GS} =0V T _J =85°C			5	
On-State Drain Current	I _{D(on)}	V _{DS} ≥ 5V, V _{GS} =4.5V	0.7			A
Drain-Source On-Resistance	R _{DS(on)}	V _{GS} =4.5V, I _D =0.6A		240	360	mΩ
		V _{GS} =2.5V, I _D =0.5A		300	420	
		V _{GS} =1.8V, I _D =0.4A		420	560	
Forward Transconductance	g _{FS}	V _{DS} =10V, I _D =0.4A		1		S
Diode Forward Voltage	V _{SD}	I _S =0.15A, V _{GS} =0V		0.65	1.2	V
Dynamic						
Input Capacitance	C _{iss}	V _{DS} =10V, V _{GS} =0V f=1MHz		70		pF
Output Capacitance	C _{oss}			20		
Reverse Transfer Capacitance	C _{rss}			8		
Total Gate Charge	Q _g	V _{DS} =10V, V _{GS} =4.5V I _D ≅0.6A		1.06	1.38	nC
Gate-Source Charge	Q _{gs}			0.18		
Gate-Drain Charge	Q _{gd}			0.32		
Turn-On Time	t _{d(on)}	V _{DD} =10V, R _L =20Ω I _D ≅0.5A, V _{GEN} =4.5V R _G =1Ω		18	26	ns
	t _r			20	28	
Turn-Off Time	t _{d(off)}			70	110	
	t _f			25	40	



Typical Characteristics

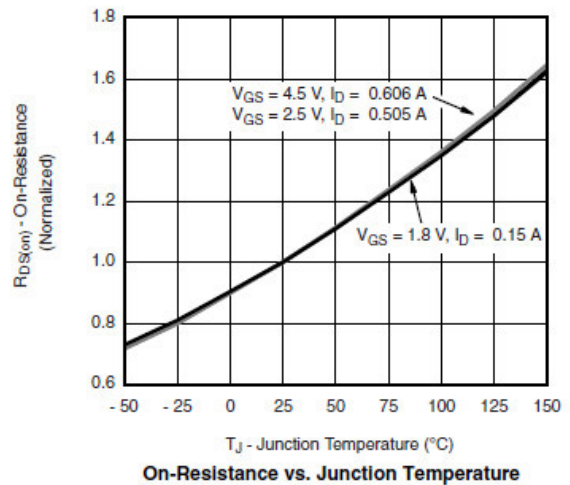
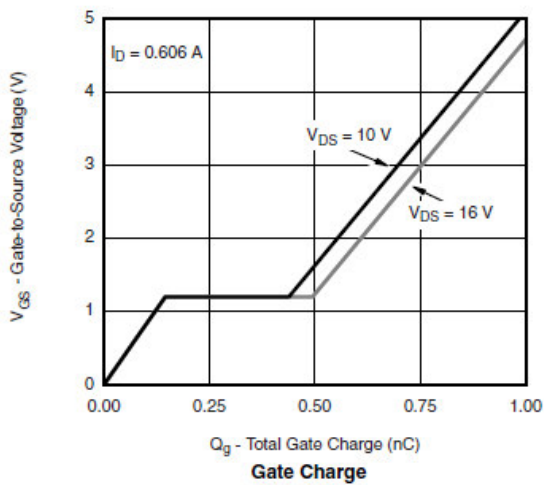
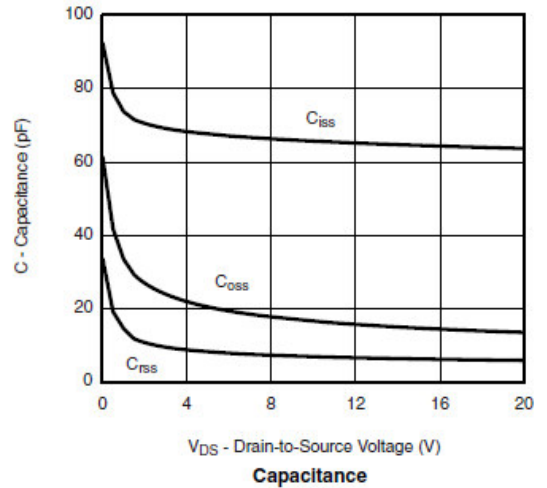
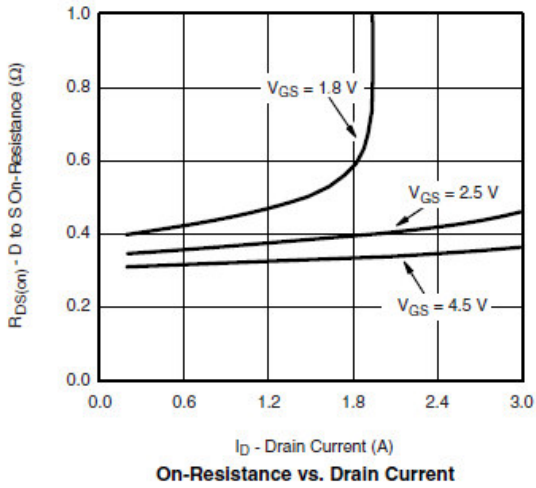
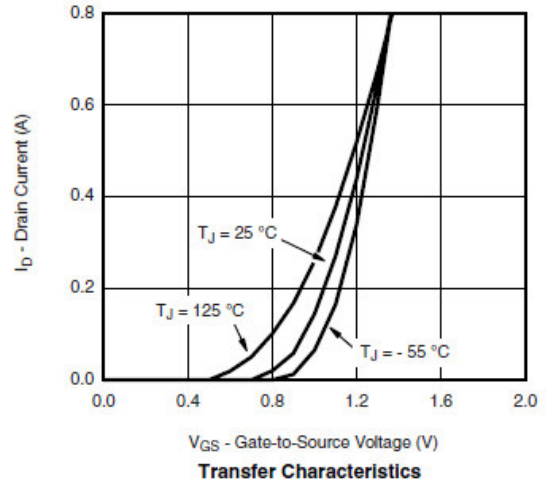
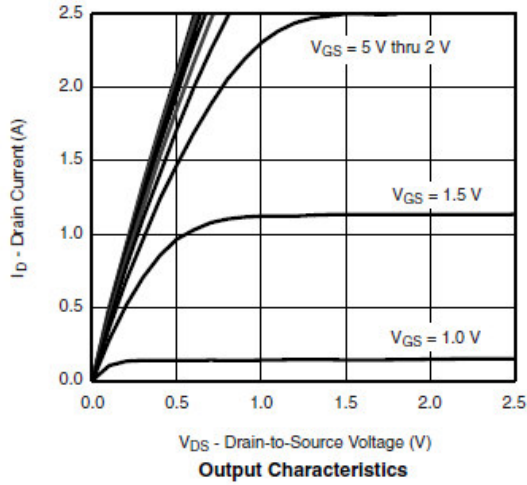



Typical Characteristics

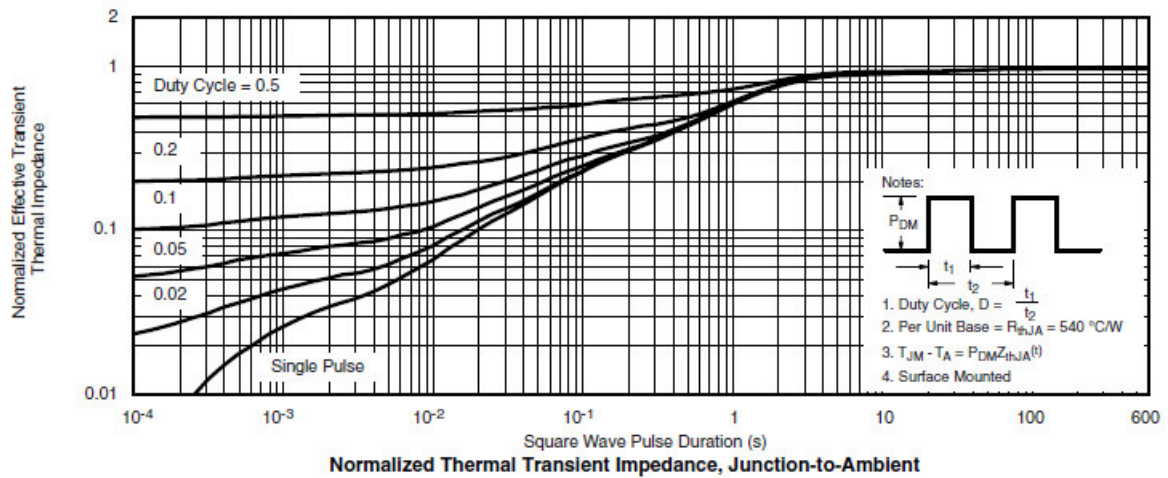
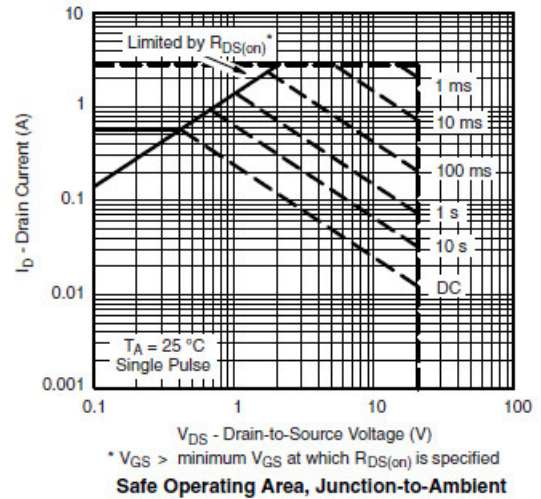
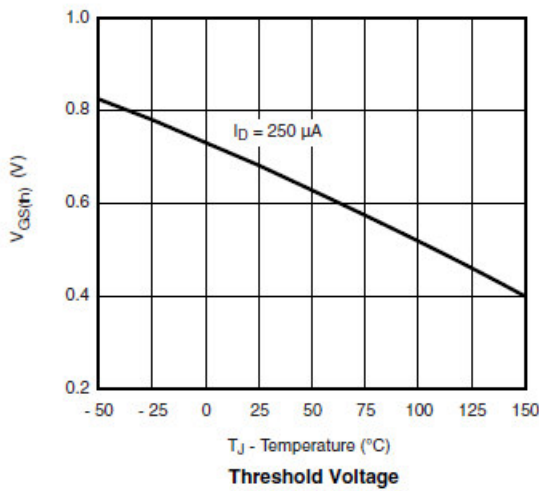
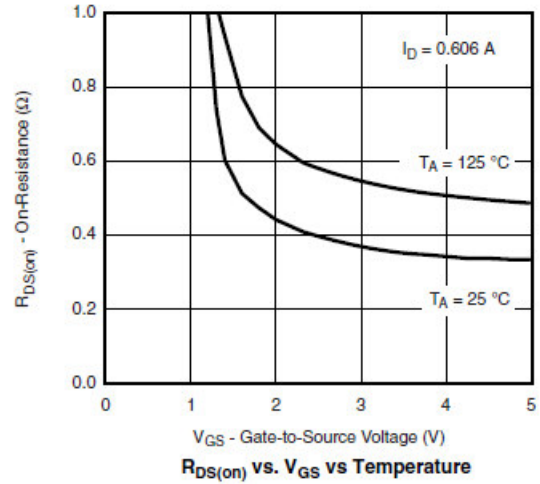
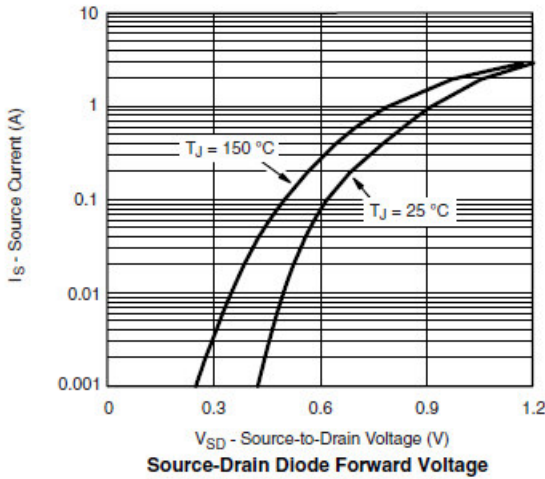



Typical Characteristics

Gate Charge Test Circuit & Waveform



Resistive Switching Test Circuit & Waveforms

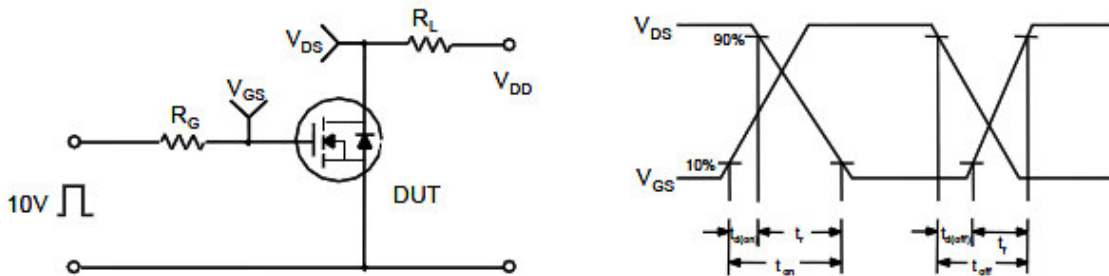

Unclamped Inductive Switching Test Circuit & Waveforms

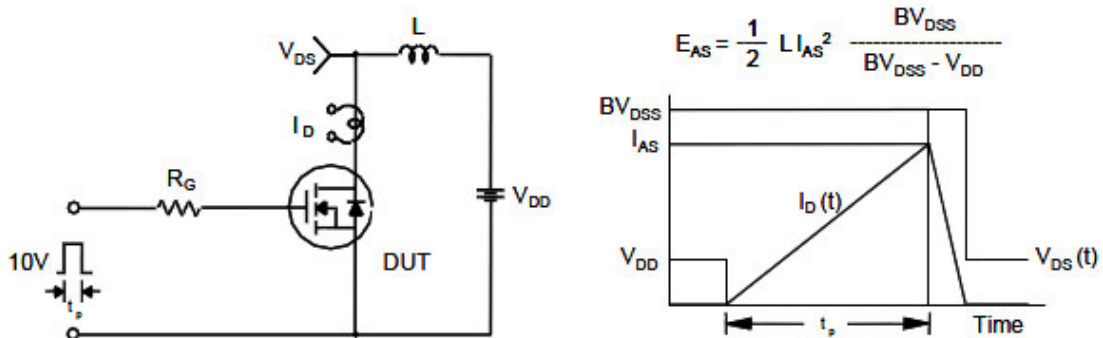



Package Information (SOT-523)

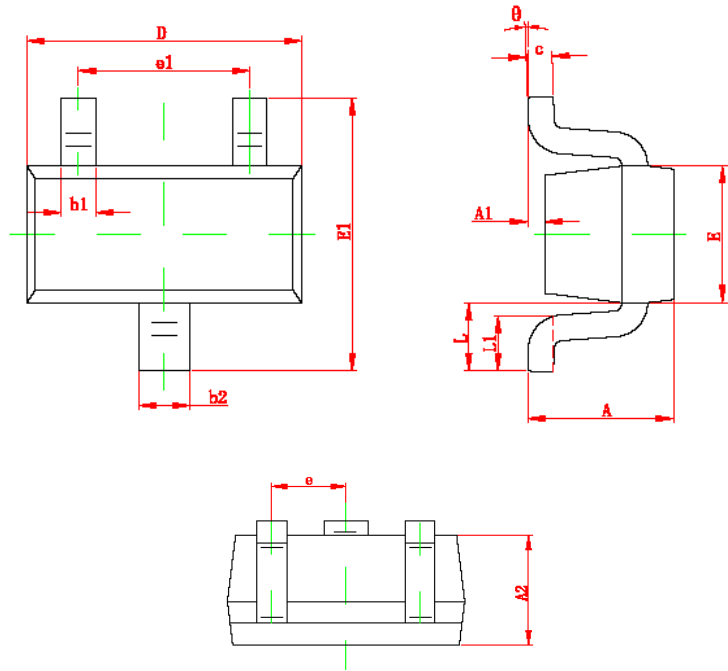

Symbol	Dimensions In Millimeters		Dimensions In Inches	
	Min	Max	Min	Max
A	0.700	0.900	0.028	0.035
A1	0.000	0.100	0.000	0.004
A2	0.700	0.800	0.028	0.031
b1	0.150	0.250	0.006	0.010
b2	0.250	0.325	0.010	0.013
c	0.100	0.200	0.004	0.008
D	1.500	1.700	0.059	0.067
E	0.750	0.850	0.030	0.033
E1	1.450	1.750	0.057	0.069
e	0.500 TYP		0.020 TYP	
e1	0.900	1.100	0.035	0.043
L	0.550 REF		0.022 REF	
L1	0.280	0.440	0.011	0.017
θ	0°	4°	0°	4°

©2010 Alfa-MOS Technology Corp.
 2F, No.80, Sec.1, Cheng Kung Rd., Nan Kang Dist., Taipei City 115, Taiwan (R.O.C.)
 Tel : 886 2) 2651 3928
 Fax : 886 2) 2786 8483
 ©http://www.alfa-mos.com