



## General Description

AFN3006S, N-Channel enhancement mode MOSFET, uses Advanced Trench Technology to provide excellent  $R_{DS(ON)}$ , low gate charge.

These devices are particularly suited for low voltage power management, and low in-line power loss are needed in commercial industrial surface mount applications.

## Features

- 30V/45A,  $R_{DS(ON)}=6m\Omega@V_{GS}=10V$
- 30V/30A,  $R_{DS(ON)}=9m\Omega@V_{GS}=4.5V$
- Super high density cell design for extremely low  $R_{DS(ON)}$
- TO-252-2L package design

## Pin Description ( TO-252-2L )

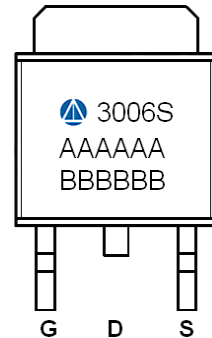
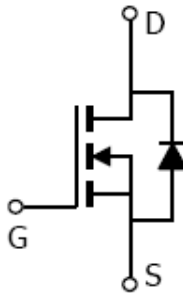
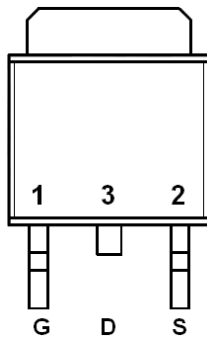

## Application

- Buck Converter
  - High Side
  - Low Side
- Synchronous Rectifier
  - Secondary Rectifier

## Pin Define

Pin	Symbol	Description
1	G	Gate
2	S	Source
3	D	Drain

## Ordering Information

Part Ordering No.	Part Marking	Package	Unit	Quantity
AFN3006ST252RG	3006S	TO-252-2L	Tape & Reel	2500 EA

- ※ A Lot code
- ※ B Date code
- ※ AFN3006ST252RG : 13" Tape & Reel ; Pb- Free ; Halogen- Free



### Absolute Maximum Ratings

(T<sub>A</sub>=25°C Unless otherwise noted)

Parameter	Symbol	Typical	Unit
Drain-Source Voltage	V <sub>DSS</sub>	30	V
Gate –Source Voltage	V <sub>GSS</sub>	±20	V
Continuous Drain Current(T <sub>J</sub> =150°C)	I <sub>D</sub>	T <sub>A</sub> =25°C	75
		T <sub>A</sub> =70°C	55
Pulsed Drain Current	I <sub>DM</sub>	200	A
Continuous Source Current(Diode Conduction)	I <sub>S</sub>	9.0	A
Power Dissipation	P <sub>D</sub>	T <sub>A</sub> =25°C	40
		T <sub>A</sub> =70°C	15
Operating Junction Temperature	T <sub>J</sub>	150	°C
Storage Temperature Range	T <sub>STG</sub>	-55/150	°C
Thermal Resistance-Junction to Ambient	R <sub>θJA</sub>	62.5	°C/W

### Electrical Characteristics

(T<sub>A</sub>=25°C Unless otherwise noted)

Parameter	Symbol	Conditions	Min.	Typ	Max.	Unit
<b>Static</b>						
Drain-Source Breakdown Voltage	V <sub>(BR)DSS</sub>	V <sub>GS</sub> =0V, I <sub>D</sub> =250uA	30			V
Gate Threshold Voltage	V <sub>GS(th)</sub>	V <sub>DS</sub> =V <sub>GS</sub> , I <sub>D</sub> =250uA	1.0		2.0	V
Gate Leakage Current	I <sub>GSS</sub>	V <sub>DS</sub> =0V, V <sub>GS</sub> =±20V			±100	nA
Zero Gate Voltage Drain Current	I <sub>DSS</sub>	V <sub>DS</sub> =24V, V <sub>GS</sub> =0V			1	uA
		V <sub>DS</sub> =24V, V <sub>GS</sub> =0V T <sub>J</sub> =85°C			10	
On-State Drain Current	I <sub>D(on)</sub>	V <sub>DS</sub> ≥ 5V, V <sub>GS</sub> =10V	15			A
Drain-Source On-Resistance	R <sub>DS(on)</sub>	V <sub>GS</sub> =10V, I <sub>D</sub> =45A		3.6	6	mΩ
		V <sub>GS</sub> =4.5V, I <sub>D</sub> =30A		5.0	9	
Forward Transconductance	g <sub>FS</sub>	V <sub>DS</sub> =15V, I <sub>D</sub> =20A		24		S
Diode Forward Voltage	V <sub>SD</sub>	I <sub>S</sub> =30A, V <sub>GS</sub> =0V		0.8	1.3	V
<b>Dynamic</b>						
Total Gate Charge	Q <sub>g</sub>	V <sub>DS</sub> =15V, V <sub>GS</sub> =10V I <sub>D</sub> ≐40A		50	70	nC
Gate-Source Charge	Q <sub>gs</sub>			10		
Gate-Drain Charge	Q <sub>gd</sub>			8		
Input Capacitance	C <sub>iss</sub>	V <sub>DS</sub> =25V, V <sub>GS</sub> =0V f=1MHz		2800		pF
Output Capacitance	C <sub>oss</sub>			550		
Reverse Transfer Capacitance	C <sub>rss</sub>			300		
Turn-On Time	t <sub>d(on)</sub>	V <sub>DD</sub> =15V, R <sub>L</sub> =0.3Ω I <sub>D</sub> ≐40A, V <sub>GEN</sub> =10V R <sub>G</sub> =2.5Ω		12	20	ns
	t <sub>r</sub>			12	20	
Turn-Off Time	t <sub>d(off)</sub>			30	45	
	t <sub>f</sub>			10	20	



## Typical Characteristics

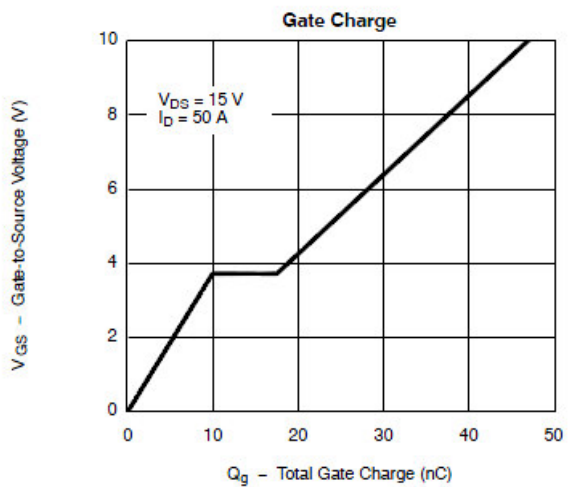
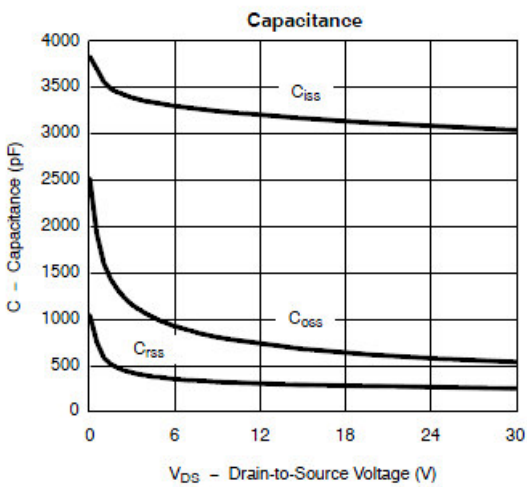
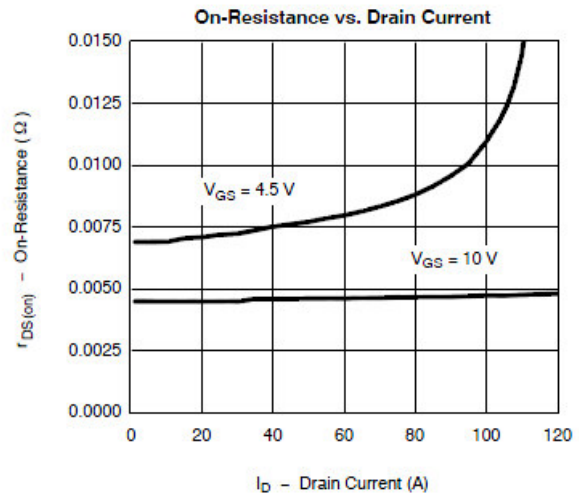
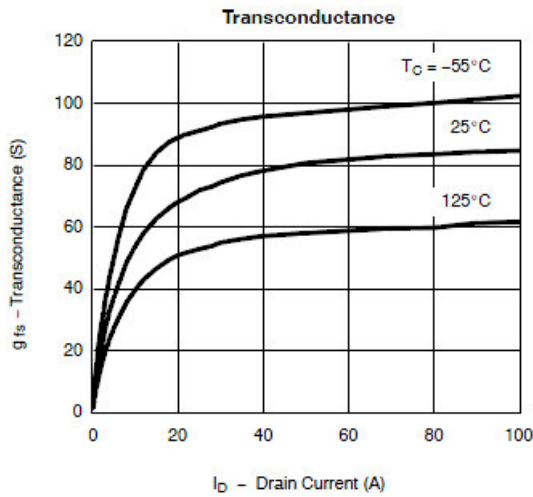
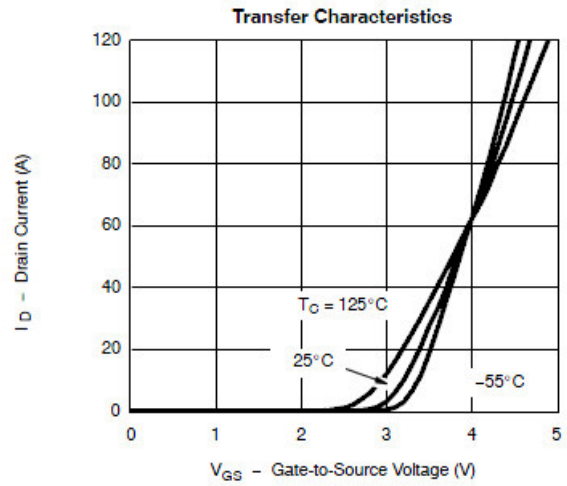
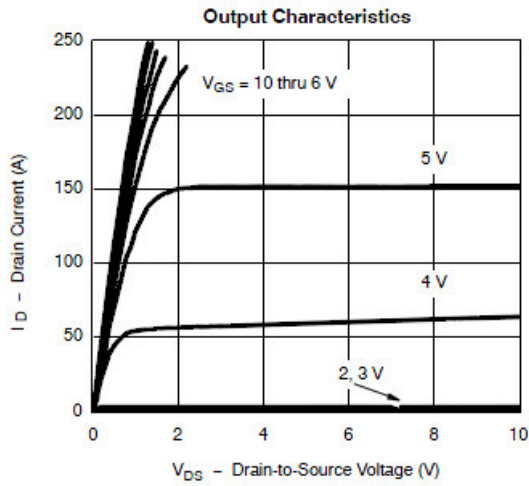



## Typical Characteristics

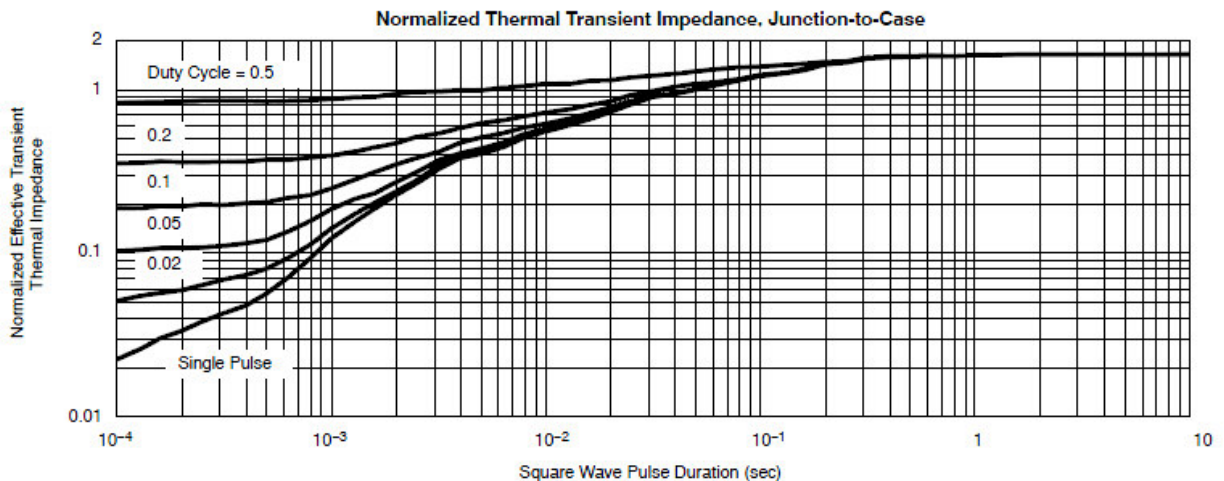
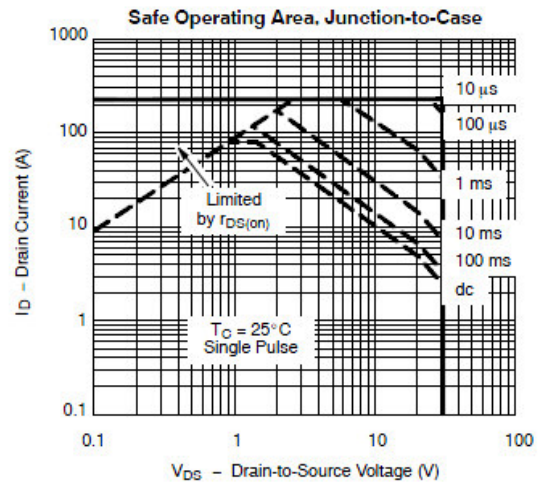
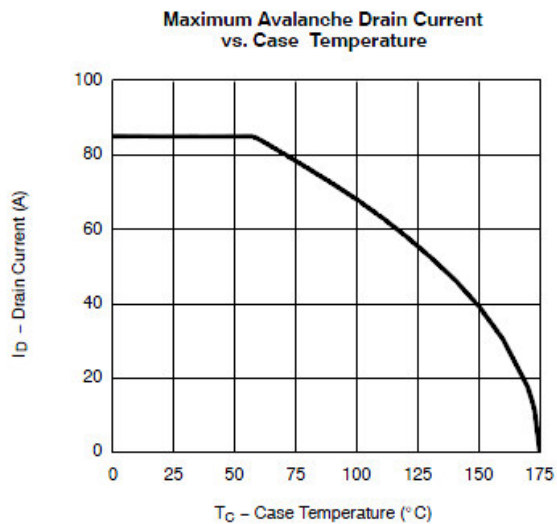
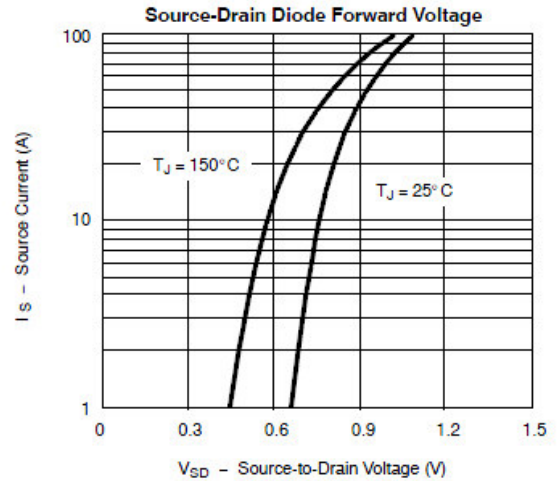
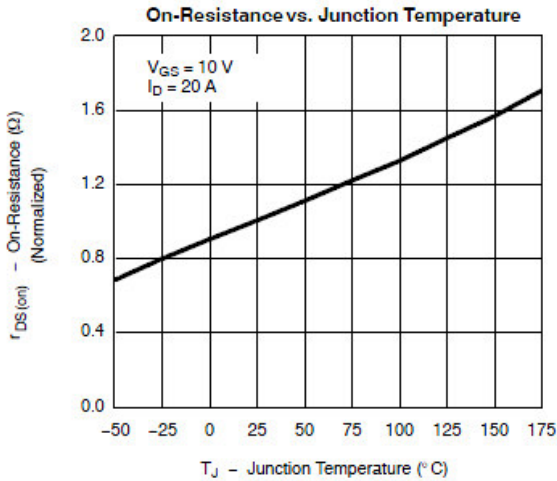



**Typical Characteristics**

Gate Charge Test Circuit & Waveform



Resistive Switching Test Circuit & Waveforms

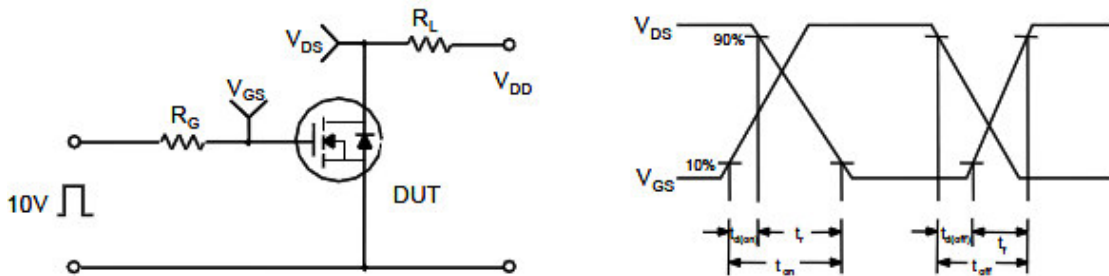

Unclamped Inductive Switching Test Circuit & Waveforms

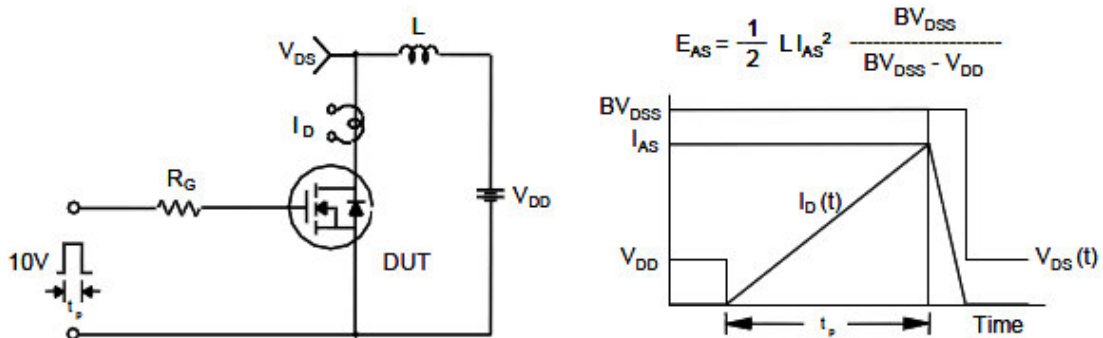



**Package Information ( TO-252-2L )**

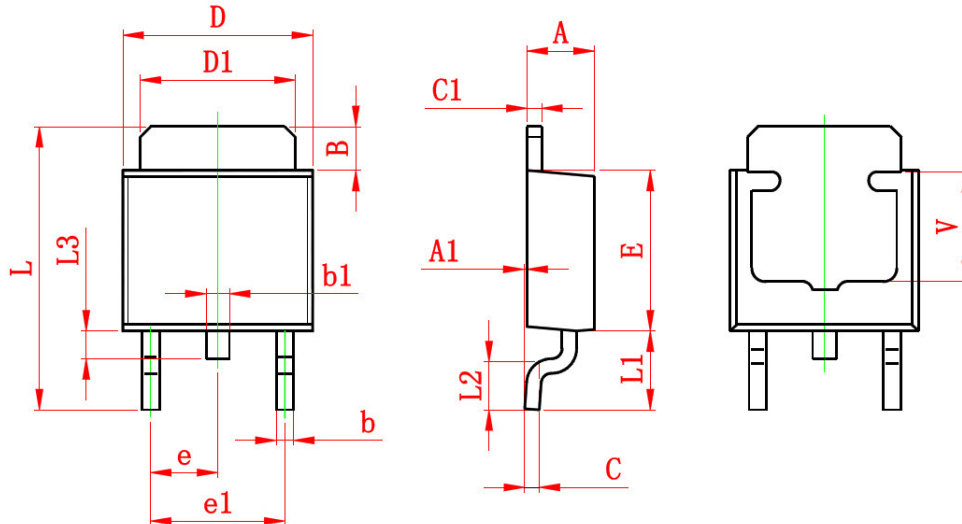

Symbol	Dimensions In Millimeters		Dimensions In Inches	
	Min.	Max.	Min.	Max.
A	2.200	2.400	0.087	0.094
A1	0.000	0.127	0.000	0.005
B	1.350	1.650	0.053	0.065
b	0.500	0.700	0.020	0.028
b1	0.700	0.900	0.028	0.035
c	0.430	0.580	0.017	0.023
c1	0.430	0.580	0.017	0.023
D	6.350	6.650	0.250	0.262
D1	5.200	5.400	0.205	0.213
E	5.400	5.700	0.213	0.224
e	2.300 TYP.		0.091 TYP.	
e1	4.500	4.700	0.177	0.185
L	9.500	9.900	0.374	0.390
L1	2.550	2.900	0.100	0.114
L2	1.400	1.780	0.055	0.070
L3	0.600	0.900	0.024	0.035
V	3.800 REF.		0.150 REF.	

©2010 Alfa-MOS Technology Corp.  
 2F, No.80, Sec.1, Cheng Kung Rd., Nan Kang Dist., Taipei City 115, Taiwan (R.O.C.)  
 Tel : 886 2) 2651 3928  
 Fax : 886 2) 2786 8483  
 ©http://www.alfa-mos.com