



General Description

AFN6003S, N-Channel enhancement mode MOSFET, uses Advanced Trench Technology to provide excellent $R_{DS(ON)}$, low gate charge.

These devices are particularly suited for low voltage power management, and low in-line power loss are needed in commercial industrial surface mount applications.

Features

- 60V/50A, $R_{DS(ON)} = 4m\Omega @ V_{GS} = 10V$
- 60V/25A, $R_{DS(ON)} = 6m\Omega @ V_{GS} = 6V$
- Super high density cell design for extremely low $R_{DS(ON)}$
- TO-220-3L package design

Pin Description (TO-220-3L)

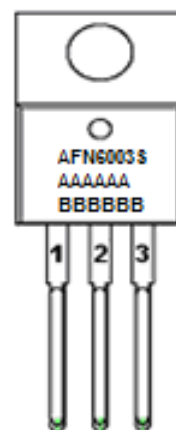
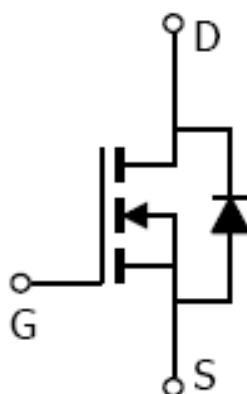
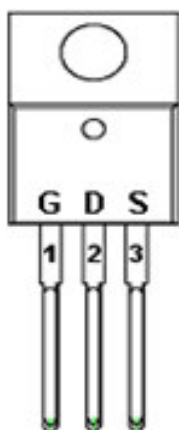

Application

- Synchronous Rectifier
- Power Supplies

Pin Define

Pin	Symbol	Description
1	G	Gate
2	D	Drain
3	S	Source

Ordering Information

Part Ordering No.	Part Marking	Package	Unit	Quantity
AFN6003ST220TG	AFN6003S AAAAAA BBBBBB	TO-220-3L	Tube	50 EA

- ※ A Lot code
- ※ B Date code
- ※ AFN6003ST220TG : Tube ; Pb- Free ; Halogen- Free



Absolute Maximum Ratings

(T_A=25°C Unless otherwise noted)

Parameter	Symbol	Typical	Unit
Drain-Source Voltage	V _{DSS}	60	V
Gate –Source Voltage	V _{GSS}	±20	V
Continuous Drain Current(T _J =150°C)	I _D	T _A =25°C	90
		T _A =70°C	45
Pulsed Drain Current	I _{DM}	180	A
Continuous Source Current(Diode Conduction)	I _S	80	
Single Pulse Avalanche Current	I _{AS}	40	
Power Dissipation	P _D	95	W
Operating Junction Temperature	T _J	150	°C
Storage Temperature Range	T _{STG}	-55/150	°C
Thermal Resistance-Junction to Ambient	R _{θJA}	62.5	°C/W

Electrical Characteristics

(T_A=25°C Unless otherwise noted)

Parameter	Symbol	Conditions	Min.	Typ	Max.	Unit
Static						
Drain-Source Breakdown Voltage	V _{(BR)DSS}	V _{GS} =0V, I _D =250uA	60			V
Gate Threshold Voltage	V _{GS(th)}	V _{DS} =V _{GS} , I _D =250uA	2.0	3.0	4.0	
Gate Leakage Current	I _{GSS}	V _{DS} =0V, V _{GS} =±20V			±100	nA
Zero Gate Voltage Drain Current	I _{DSS}	V _{DS} =48V, V _{GS} =0V			1	uA
		V _{DS} =48V, V _{GS} =0V T _J =85°C			30	
On-State Drain Current	I _{D(on)}	V _{DS} ≥ 10V, V _{GS} =10V	80			A
Drain-Source On-Resistance	R _{DS(on)}	V _{GS} =10V, I _D =50A		2.8	4	mΩ
		V _{GS} =6V, I _D =25A		3.8	6	
Forward Transconductance	g _{FS}	V _{DS} =10V, I _D =40A		80		S
Diode Forward Voltage	V _{SD}	I _S =30A, V _{GS} =0V		0.8	1.3	V
Dynamic						
Total Gate Charge	Q _g	V _{DS} =30V, V _{GS} =10V I _D ≡20A		100	150	nC
Gate-Source Charge	Q _{gs}			30		
Gate-Drain Charge	Q _{gd}			45		
Input Capacitance	C _{iss}	V _{DS} =30V, V _{GS} =0V f=1MHz		3450	6500	pF
Output Capacitance	C _{oss}			1100		
Reverse Transfer Capacitance	C _{rss}			400		
Turn-On Time	t _{d(on)}	V _{DD} =30V, R _L =1.5Ω I _D ≡20A, V _{GEN} =10V R _G =3.0Ω		30	60	ns
	t _r			30	60	
Turn-Off Time	t _{d(off)}			40	80	
	t _f			15	30	



Typical Characteristics

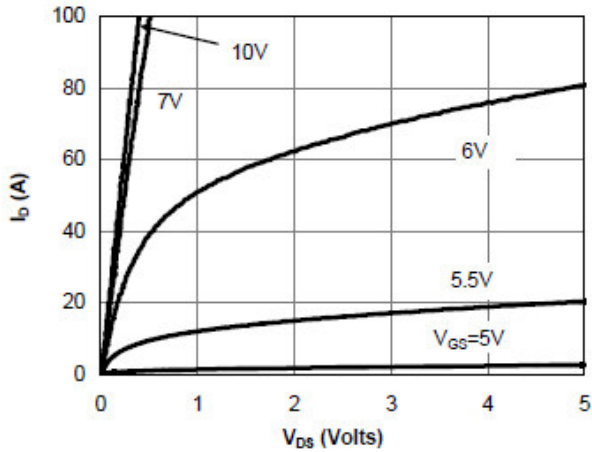

On-Region Characteristics

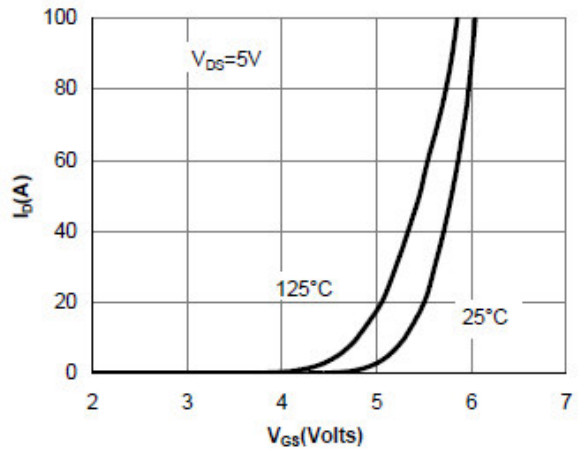

Transfer Characteristics

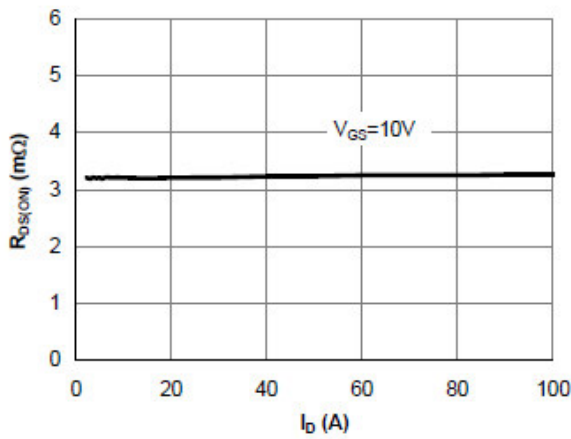

On-Resistance vs. Drain Current and Gate Voltage

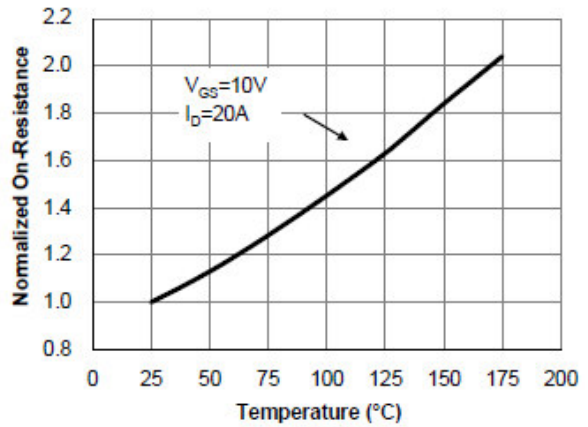

On-Resistance vs. Junction Temperature

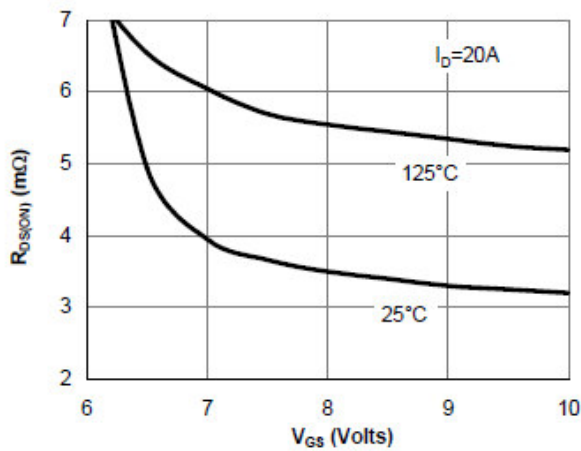

On-Resistance vs. Gate-Source Voltage

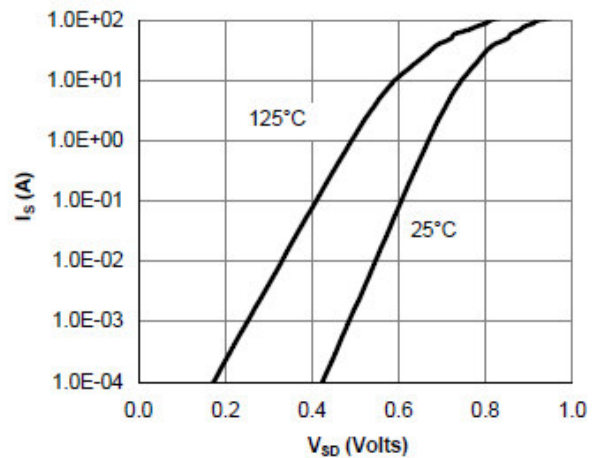

Body-Diode Characteristics



Typical Characteristics

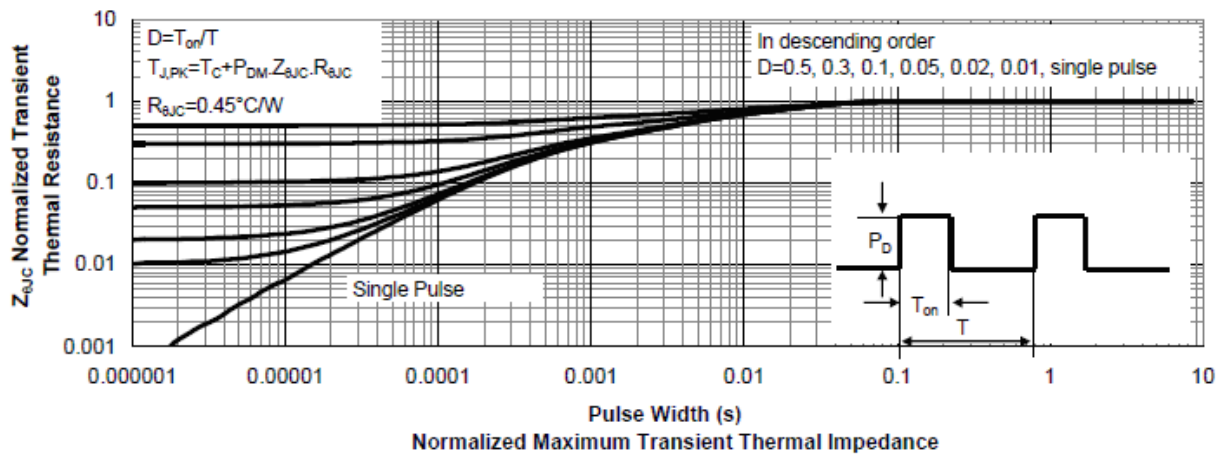
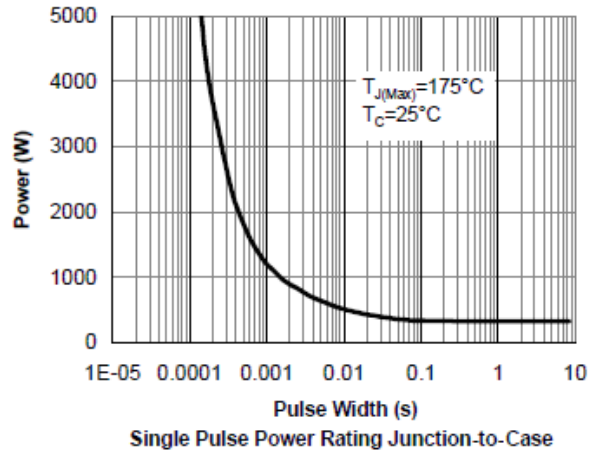
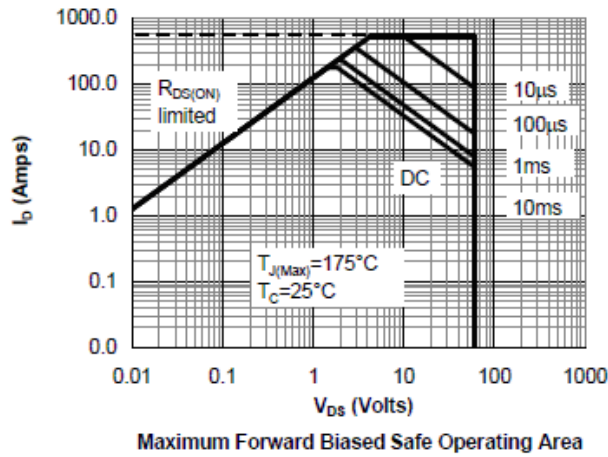
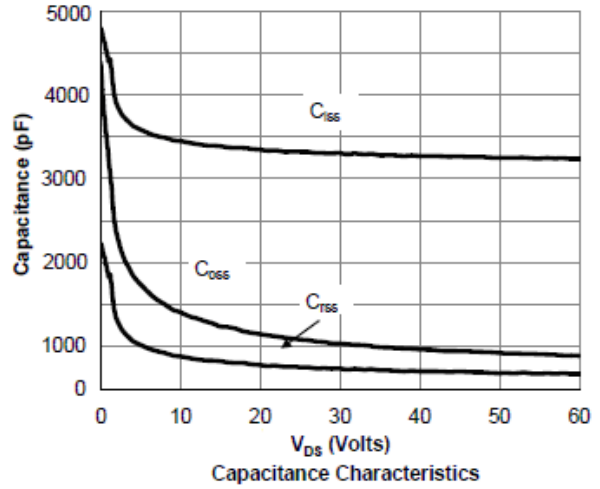
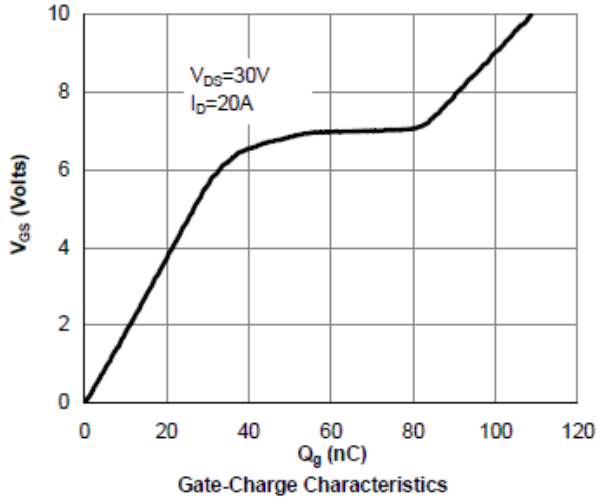



Typical Characteristics

Gate Charge Test Circuit & Waveform



Resistive Switching Test Circuit & Waveforms



Unclamped Inductive Switching Test Circuit & Waveforms





Package Information (TO-220-3L)

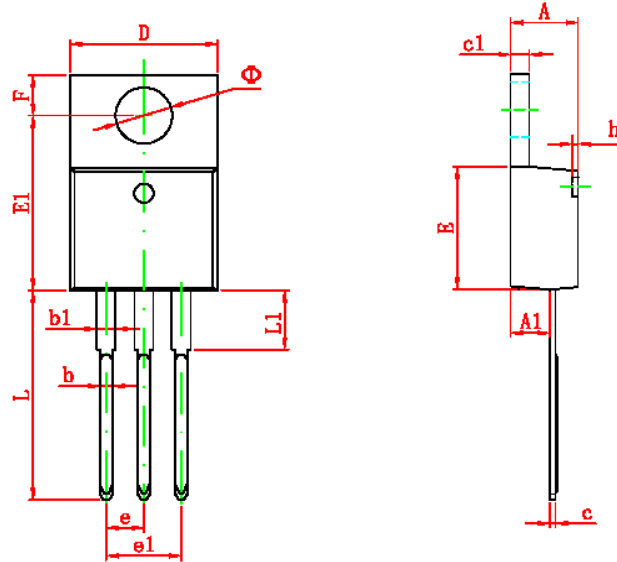

Symbol	Dimensions In Millimeters		Dimensions In Inches	
	Min	Max	Min	Max
A	4.470	4.670	0.176	0.184
A1	2.520	2.820	0.099	0.111
b	0.710	0.910	0.028	0.036
b1	1.170	1.370	0.046	0.054
c	0.310	0.530	0.012	0.021
c1	1.170	1.370	0.046	0.054
D	10.010	10.310	0.394	0.406
E	8.500	8.900	0.335	0.350
E1	12.060	12.460	0.475	0.491
e	2.540 TYP		0.100 TYP	
e1	4.980	5.180	0.196	0.204
F	2.590	2.890	0.102	0.114
h	0.000	0.300	0.000	0.012
L	13.400	13.800	0.528	0.543
L1	3.560	3.960	0.140	0.156
• •	3.735	3.935	0.147	0.155

©2010 Alfa-MOS Technology Corp.
 2F, No.80, Sec.1, Cheng Kung Rd., Nan Kang Dist., Taipei City 115, Taiwan (R.O.C.)
 Tel : 886 2) 2651 3928
 Fax : 886 2) 2786 8483
 ©http://www.alfa-mos.com