



General Description

AFP1810, P-Channel enhancement mode MOSFET, uses Advanced Trench Technology to provide excellent $R_{DS(ON)}$, low gate charge.

These devices are particularly suited for low voltage power management, and low in-line power loss are needed in commercial industrial surface mount applications.

Features

- -100/-2.0A, $R_{DS(ON)} = 230m\Omega @ V_{GS} = -10V$
- -100/-1.0A, $R_{DS(ON)} = 245m\Omega @ V_{GS} = -4.5V$
- Super high density cell design for extremely low $R_{DS(ON)}$
- SOP-8P package design

Pin Description (SOP-8P)

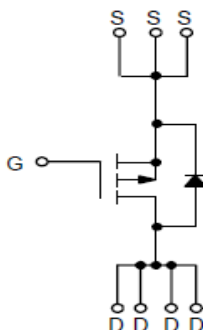
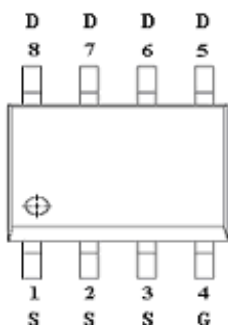

Application

- Full Bridge DC/DC Converter
- Load Switch

Pin Define

Pin	Symbol	Description
1	S	Source
2	S	Source
3	S	Source
4	G	Gate
5	D	Drain
6	D	Drain
7	D	Drain
8	D	Drain

Ordering Information

Part Ordering No.	Part Marking	Package	Unit	Quantity
AFP1810S8RG	1810	SOP-8P	Tape & Reel	3000 EA

※ A Lot code

※ B Date code

※ AFP1810S8RG : 13" Tape & Reel ; Pb- Free ; Halogen- Free



Absolute Maximum Ratings

($T_A=25^{\circ}\text{C}$ Unless otherwise noted)

Parameter	Symbol	Typical	Unit
Drain-Source Voltage	V_{DSS}	-100	V
Gate –Source Voltage	V_{GSS}	± 20	V
Continuous Drain Current($T_J=150^{\circ}\text{C}$)	I_D	$T_A=25^{\circ}\text{C}$	-2.5
		$T_A=70^{\circ}\text{C}$	-2.0
Pulsed Drain Current	I_{DM}	-10	A
Continuous Source Current(Diode Conduction)	I_S	-2	A
Power Dissipation	P_D	$T_A=25^{\circ}\text{C}$	2.8
		$T_A=70^{\circ}\text{C}$	1.8
Operating Junction Temperature	T_J	150	$^{\circ}\text{C}$
Storage Temperature Range	T_{STG}	-55/150	$^{\circ}\text{C}$
Thermal Resistance-Junction to Ambient	$R_{\theta JA}$	62.5	$^{\circ}\text{C/W}$

Electrical Characteristics

($T_A=25^{\circ}\text{C}$ Unless otherwise noted)

Parameter	Symbol	Conditions	Min.	Typ	Max.	Unit
Static						
Drain-Source Breakdown Voltage	$V_{(BR)DSS}$	$V_{GS}=0V, I_D = -250\mu A$	-100			V
Gate Threshold Voltage	$V_{GS(th)}$	$V_{DS}=V_{GS}, I_D = -250\mu A$	-1.0		-2.5	
Gate Leakage Current	I_{GSS}	$V_{DS}=0V, V_{GS} = \pm 20V$			± 100	nA
Zero Gate Voltage Drain Current	I_{DSS}	$V_{DS} = -80V, V_{GS}=0V$			-1	
		$V_{DS} = -80V, V_{GS}=0V$ $T_J=85^{\circ}\text{C}$			-30	μA
Drain-Source On-Resistance	$R_{DS(on)}$	$V_{GS} = -10V, I_D=-2.0A$		195	230	$m\Omega$
		$V_{GS} = -4.5V, I_D=-1.0A$		220	245	
Forward Transconductance	g_{FS}	$V_{DS} = -15V, I_D = -2.0A$		9		S
Diode Forward Voltage	V_{SD}	$I_S = -2A, V_{GS}=0V$		-0.8	-1.3	V
Dynamic						
Total Gate Charge	Q_g	$V_{DS}=-50V, V_{GS}=-4.5V$ $I_D = -2.0A$		12	20	nC
Gate-Source Charge	Q_{gs}			3.0		
Gate-Drain Charge	Q_{gd}			4.5		
Input Capacitance	C_{iss}	$V_{DS}=-25V, V_{GS}=0V$ $f=1\text{MHz}$		1300		pF
Output Capacitance	C_{oss}			100		
Reverse Transfer Capacitance	C_{rss}			60		
Turn-On Time	$t_{d(on)}$	$V_{DD}=-50V, R_L=10\Omega$ $I_D \equiv -1.0A, V_{GEN}=-10V$ $R_G=1\Omega$		8	15	ns
	t_r			15	20	
Turn-Off Time	$t_{d(off)}$			35	50	
	t_f			10	25	



Typical Characteristics

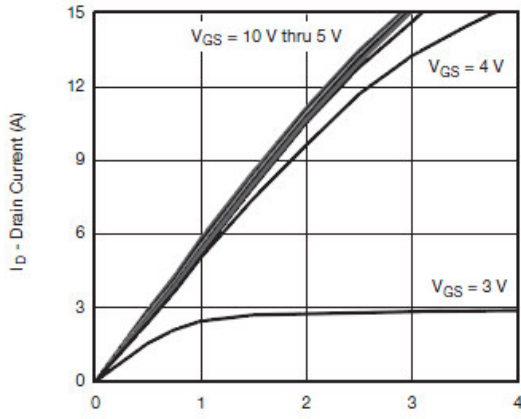

Output Characteristics

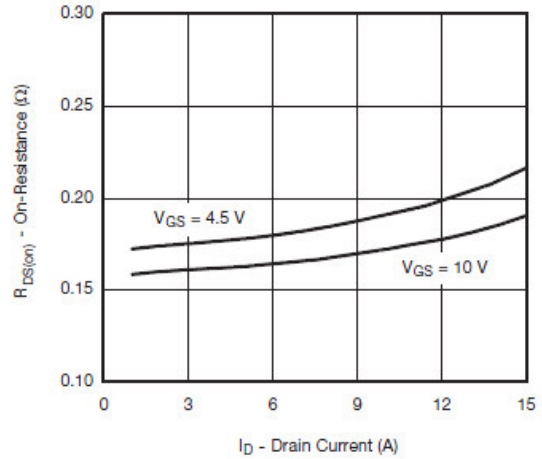

On-Resistance vs. Drain Current

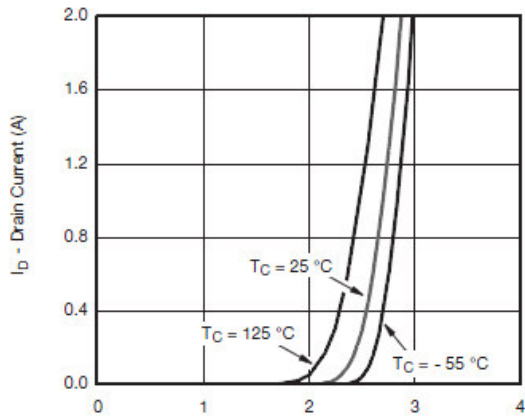

Transfer Characteristics

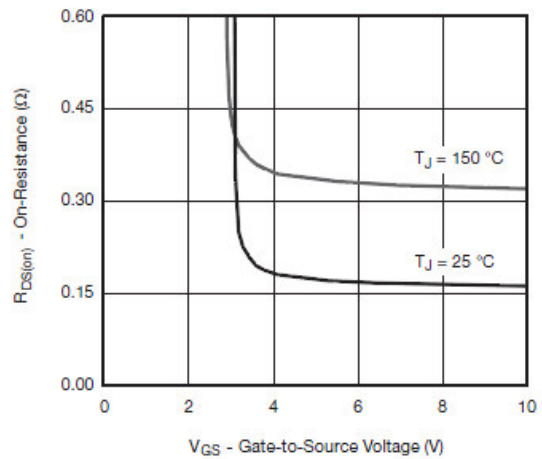

On-Resistance vs. Gate-to-Source Voltage

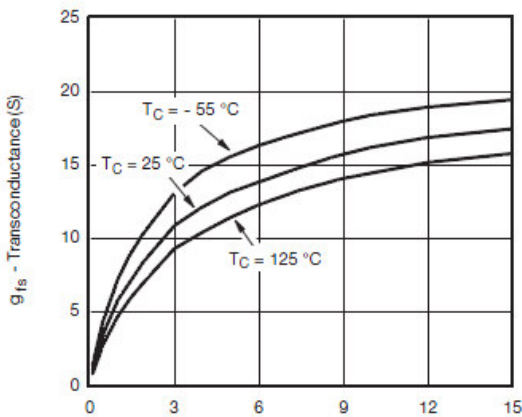

Transconductance

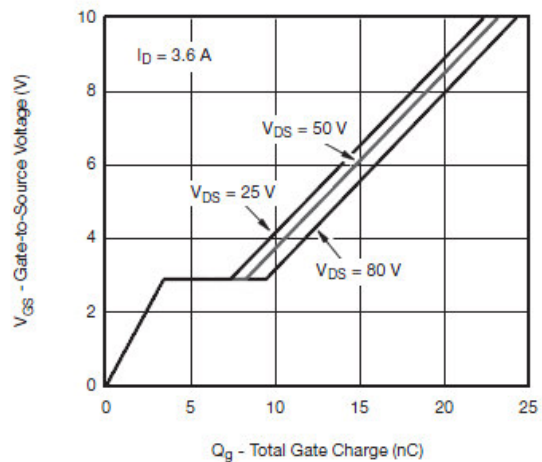

Gate Charge



Typical Characteristics

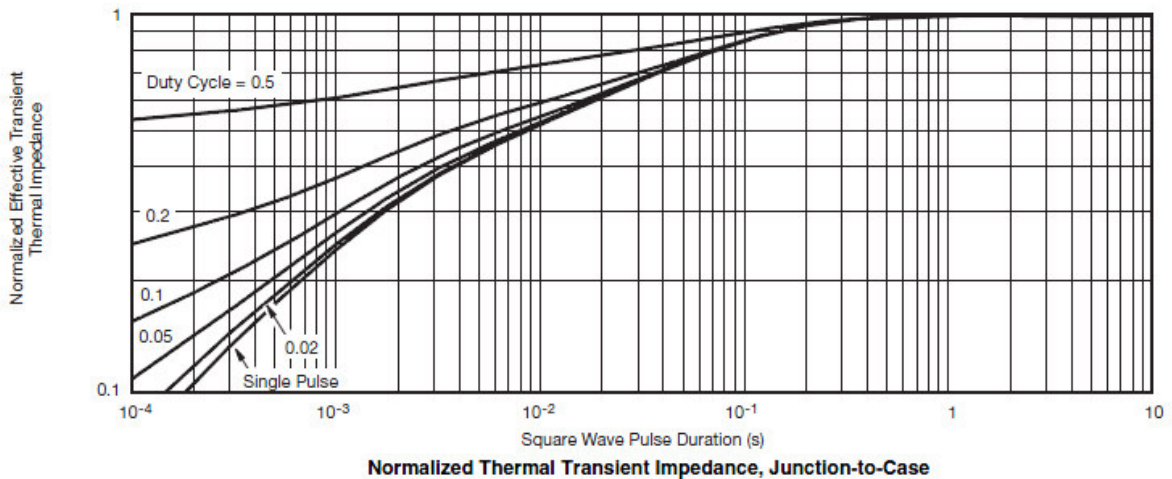
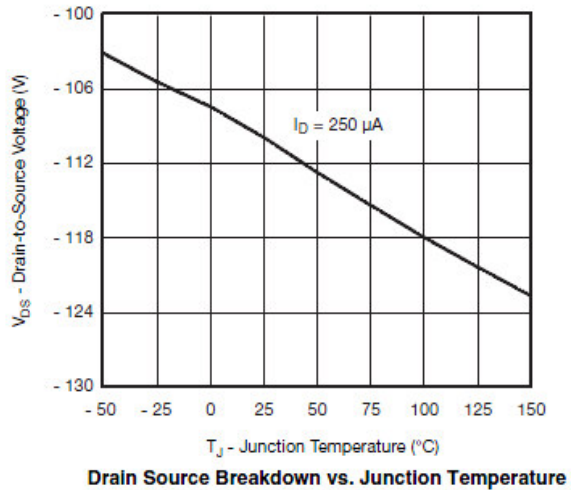
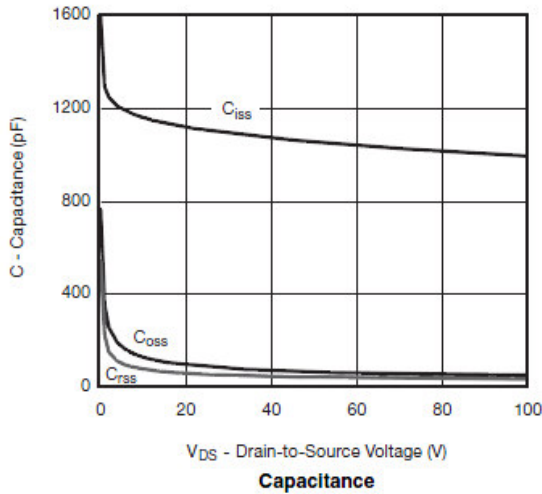
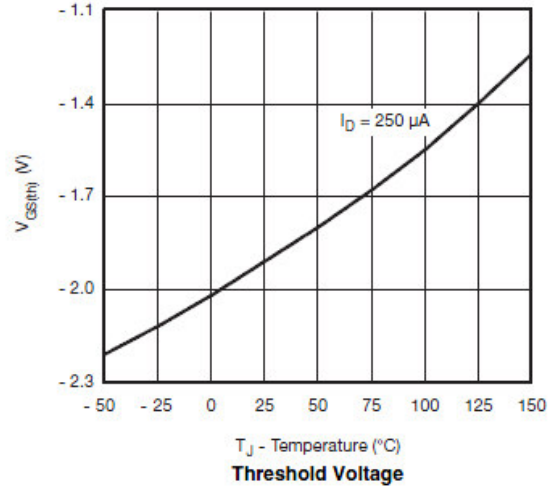
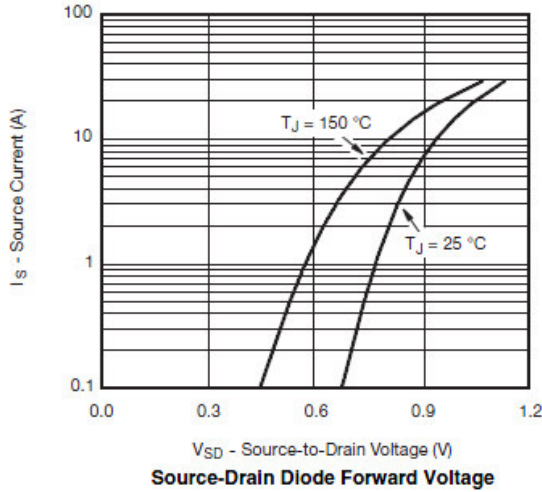



Typical Characteristics

Gate Charge Test Circuit & Waveform

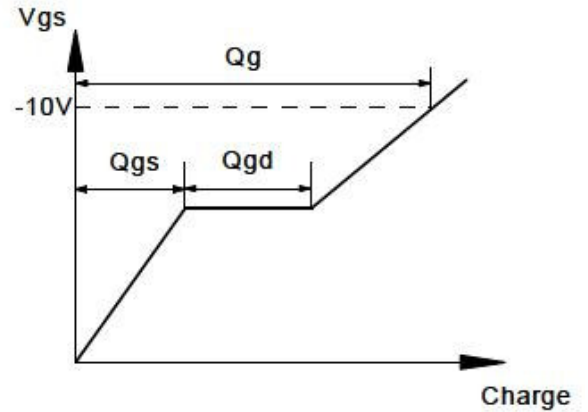
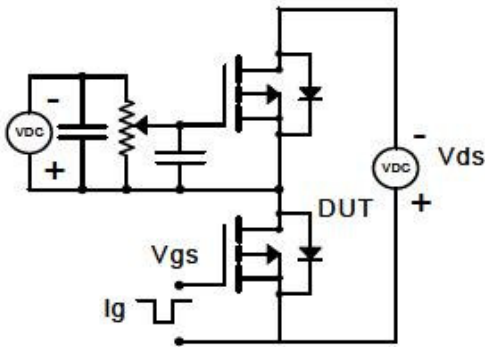

Resistive Switching Test Circuit & Waveforms

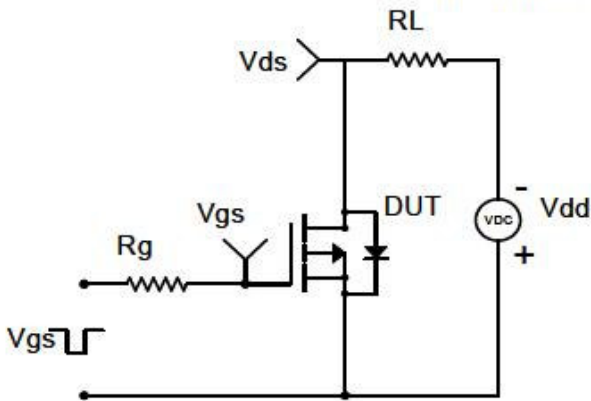

Diode Recovery Test Circuit & Waveforms

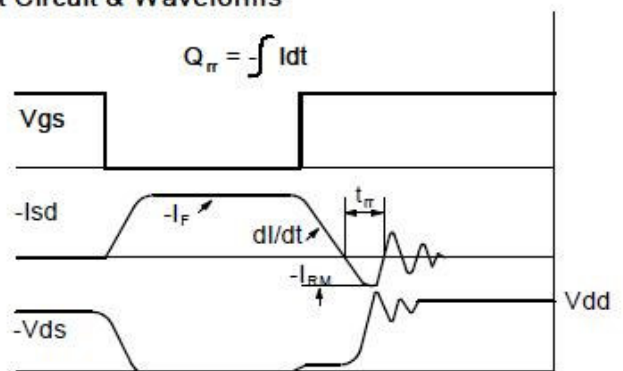
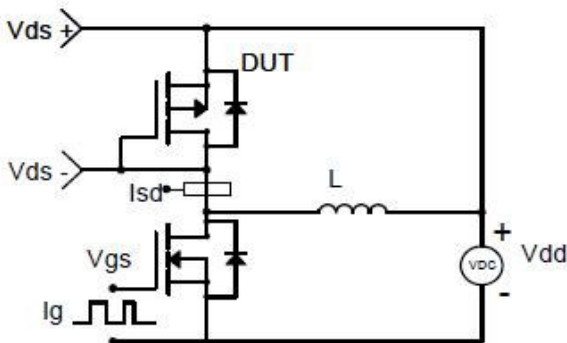



Package Information (SOP-8P)

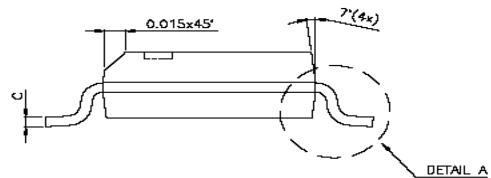
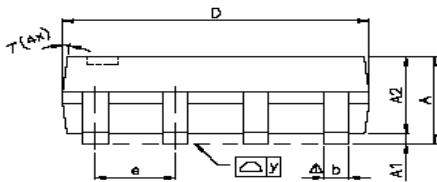
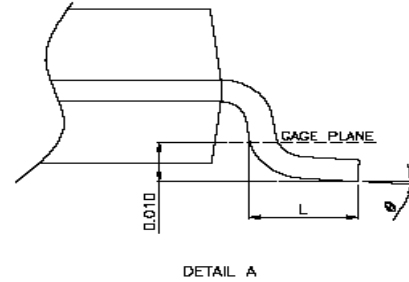
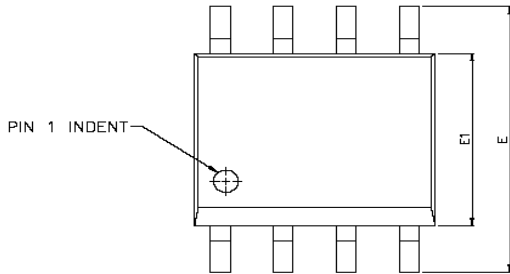

SYMBOLS	DIMENSIONS IN MILLIMETERS			DIMENSIONS IN INCHES		
	MIN	NOM	MAX	MIN	NOM	MAX
A	1.47	1.60	1.73	0.058	0.063	0.068
A1	0.10	—	0.25	0.004	—	0.010
A2	—	1.45	—	—	0.057	—
b	0.33	0.41	0.51	0.013	0.016	0.020
C	0.19	0.20	0.25	0.0075	0.008	0.0098
D	4.80	4.85	4.95	0.189	0.191	0.195
E	5.80	6.00	6.20	0.228	0.236	0.244
E1	3.80	3.90	4.00	0.150	0.154	0.157
e	—	1.27	—	—	0.050	—
L	0.38	0.71	1.27	0.015	0.028	0.050
Δ y	—	—	0.076	—	—	0.003
θ	0°	—	8°	0°	—	8°

©2010 Alfa-MOS Technology Corp.
 2F, No.80, Sec.1, Cheng Kung Rd., Nan Kang Dist., Taipei City 115, Taiwan (R.O.C.)
 Tel : 886 2) 2651 3928
 Fax : 886 2) 2786 8483
 ©http://www.alfa-mos.com