



### General Description

AFP4435WS, P-Channel enhancement mode MOSFET, uses Advanced Trench Technology to provide excellent  $R_{DS(ON)}$ , low gate charge. These devices are particularly suited for low voltage power management, and low in-line power loss are needed in commercial industrial surface mount applications.

### Features

- $I_D = -9A, R_{DS(ON)} = 15m\Omega @ V_{GS} = -10V$
- $I_D = -7A, R_{DS(ON)} = 23m\Omega @ V_{GS} = -4.5V$
- Super high density cell design for extremely low  $R_{DS(ON)}$
- SOP-8P package design

### Pin Description ( SOP-8P )

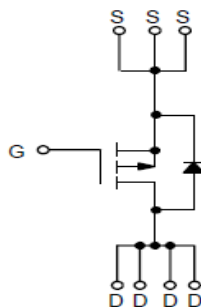
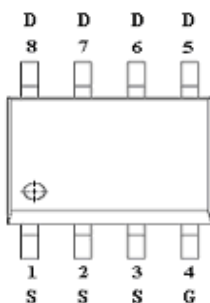

### Application

- LED Display
- Load Switch
- CCFL Inverter
- Power Management in Notebook Computer,

### Pin Define

Pin	Symbol	Description
1	S	Source
2	S	Source
3	S	Source
4	G	Gate
5	D	Drain
6	D	Drain
7	D	Drain
8	D	Drain

### Ordering Information

Part Ordering No.	Part Marking	Package	Unit	Quantity
AFP4435WSS8RG	4435WS	SOP-8P	Tape & Reel	2500 EA

※ A Lot code

※ B Date code

※ AFP4435WSS8RG : 13" Tape & Reel ; Pb- Free ; Halogen -Free



### Absolute Maximum Ratings

(T<sub>A</sub>=25°C Unless otherwise noted)

Parameter	Symbol	Value	Unit
Drain-Source Voltage	V <sub>DSS</sub>	-30	V
Gate –Source Voltage	V <sub>GSS</sub>	±20	V
Continuous Drain Current(T <sub>J</sub> =150°C)	I <sub>D</sub>	T <sub>A</sub> =25°C	-9.0
		T <sub>A</sub> =70°C	-7.0
Pulsed Drain Current	I <sub>DM</sub>	-40	A
Continuous Source Current(Diode Conduction)	I <sub>S</sub>	-2	A
Power Dissipation	P <sub>D</sub>	T <sub>A</sub> =25°C	2.8
		T <sub>A</sub> =70°C	1.8
Operating Junction Temperature	T <sub>J</sub>	150	°C
Storage Temperature Range	T <sub>STG</sub>	-55/150	°C
Thermal Resistance-Junction to Ambient	R <sub>θJA</sub>	62.5	°C/W
Thermal Resistance-Junction to Case	R <sub>θJC</sub>	19	°C/W

### Electrical Characteristics

(T<sub>A</sub>=25°C Unless otherwise noted)

Parameter	Symbol	Conditions	Min.	Typ	Max.	Unit
<b>Static</b>						
Drain-Source Breakdown Voltage	V <sub>(BR)DSS</sub>	V <sub>GS</sub> =0V, I <sub>D</sub> =-250uA	-30			V
Gate Threshold Voltage	V <sub>GS(th)</sub>	V <sub>DS</sub> =V <sub>GS</sub> , I <sub>D</sub> =-250uA	-1.0		-2.0	
Gate Leakage Current	I <sub>GSS</sub>	V <sub>DS</sub> =0V, V <sub>GS</sub> =±25V			±100	nA
Zero Gate Voltage Drain Current	I <sub>DSS</sub>	V <sub>DS</sub> =-24V, V <sub>GS</sub> =0V			-1	uA
		V <sub>DS</sub> =-24V, V <sub>GS</sub> =0V T <sub>J</sub> =85°C			-30	
On-State Drain Current	I <sub>D(on)</sub>	V <sub>DS</sub> ≤ -10V, V <sub>GS</sub> =-10V	-30			A
		V <sub>DS</sub> ≤ -5V, V <sub>GS</sub> =-4.5V	-5			
Drain-Source On-Resistance	R <sub>DS(on)</sub>	V <sub>GS</sub> =-10V, I <sub>D</sub> =-9.0A		12	15	mΩ
		V <sub>GS</sub> =-4.5V, I <sub>D</sub> =-7.0A		17	23	
Forward Transconductance	g <sub>FS</sub>	V <sub>DS</sub> =-10V, I <sub>D</sub> =-9.0A		22		S
Diode Forward Voltage	V <sub>SD</sub>	I <sub>S</sub> =-2.3A, V <sub>GS</sub> =0V		-0.7	-1.3	V
<b>Dynamic</b>						
Total Gate Charge	Q <sub>g</sub>	V <sub>DS</sub> =-15V, V <sub>GS</sub> =-4.5V I <sub>D</sub> ≡-6.0A		20	30	nC
Gate-Source Charge	Q <sub>gs</sub>			6		
Gate-Drain Charge	Q <sub>gd</sub>			10		
Input Capacitance	C <sub>iss</sub>	V <sub>DS</sub> =-15V, V <sub>GS</sub> =0V f=1MHz		1600		pF
Output Capacitance	C <sub>oss</sub>			350		
Reverse Transfer Capacitance	C <sub>rss</sub>			300		
Turn-On Time	t <sub>d(on)</sub>	V <sub>DD</sub> =-15V, R <sub>L</sub> =3Ω I <sub>D</sub> ≡-5.0A, V <sub>GEN</sub> =-10V R <sub>G</sub> =1Ω		10	20	ns
	t <sub>r</sub>			12	24	
Turn-Off Time	t <sub>d(off)</sub>			30	45	
	t <sub>f</sub>			10	20	



## Typical Characteristics

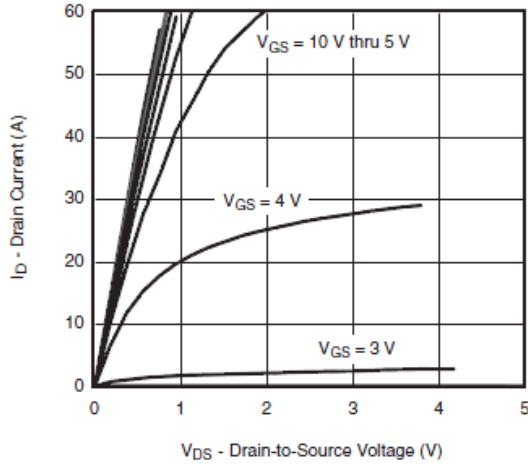

Output Characteristics

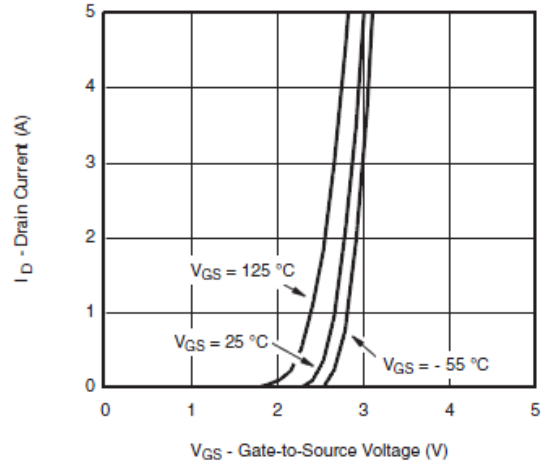

Transfer Characteristics

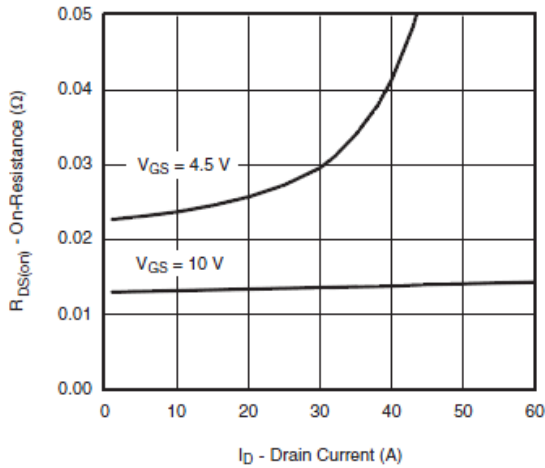

On-Resistance vs. Drain Current

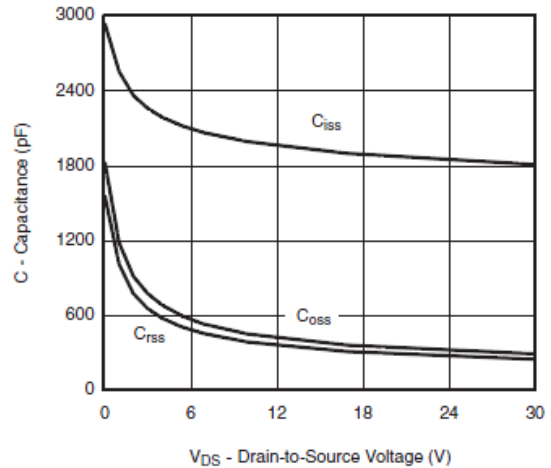

Capacitance

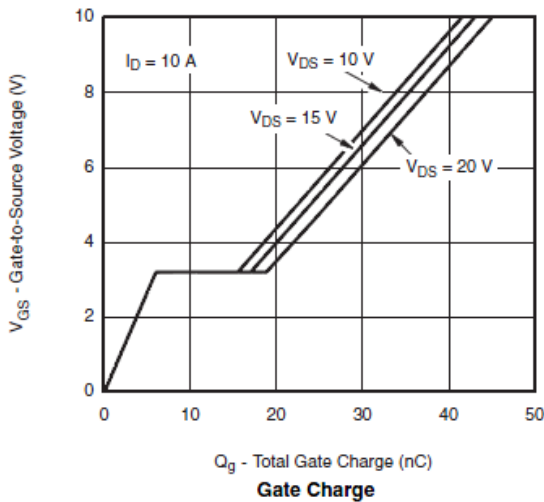

Gate Charge

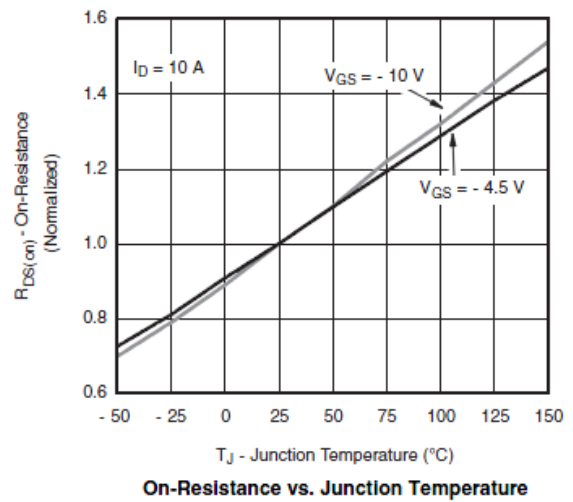

On-Resistance vs. Junction Temperature



## Typical Characteristics

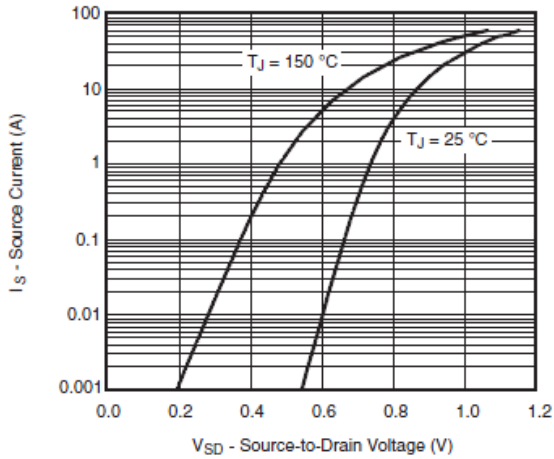

Source-Drain Diode Forward Voltage

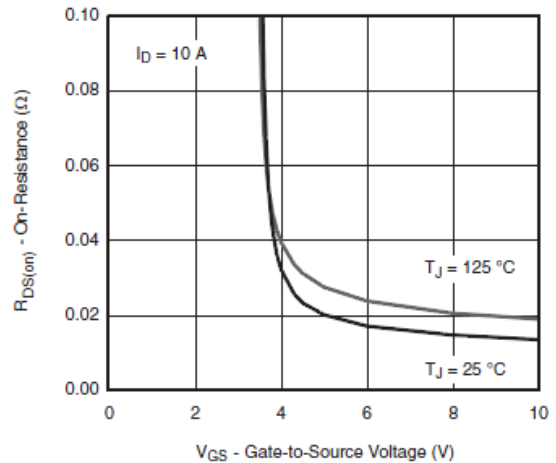

On-Resistance vs. Gate-to-Source Voltage

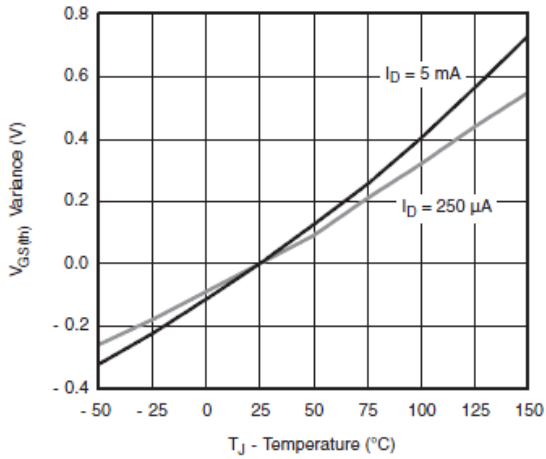

Threshold Voltage

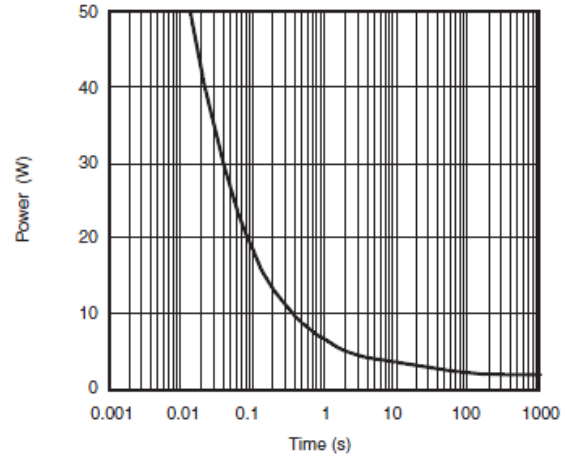

Single Pulse Power, Junction-to-Ambient

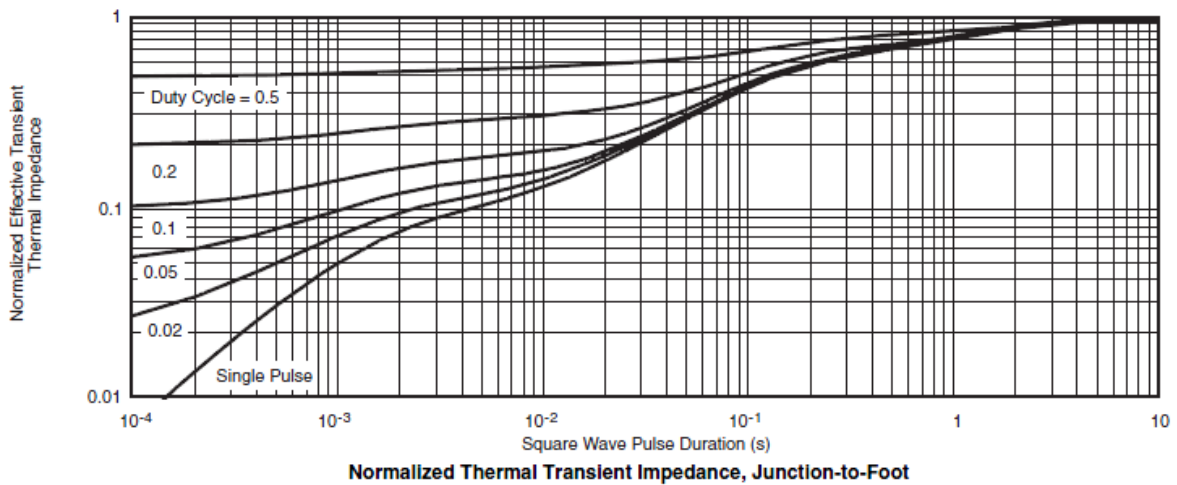

Normalized Thermal Transient Impedance, Junction-to-Foot



**Typical Characteristics**

Gate Charge Test Circuit & Waveform

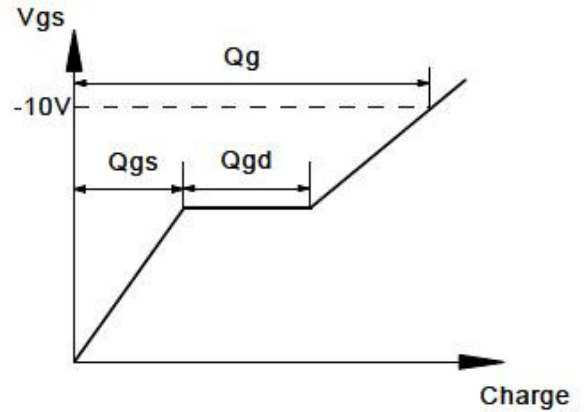
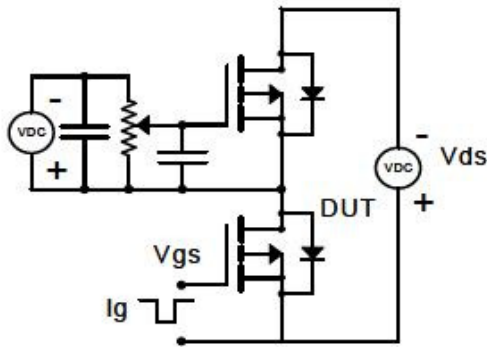

Resistive Switching Test Circuit & Waveforms

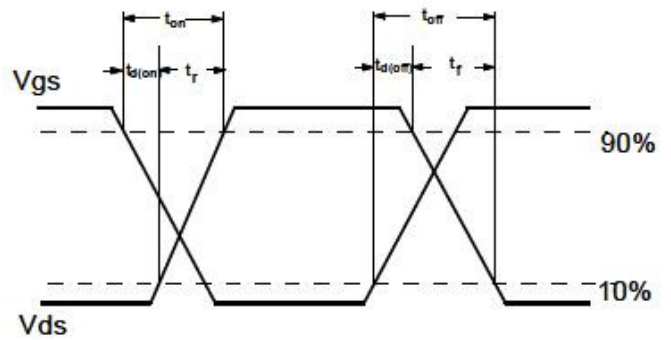
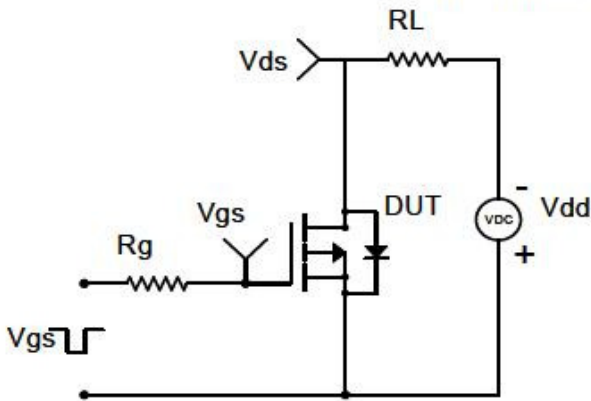

Diode Recovery Test Circuit & Waveforms

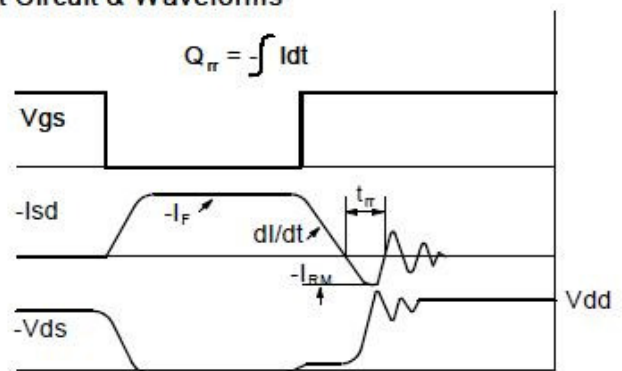
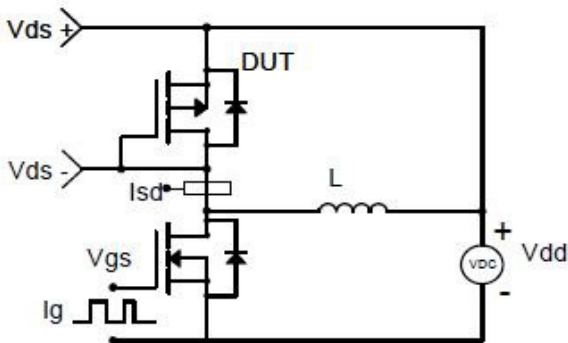



**Package Information (SOP-8P )**

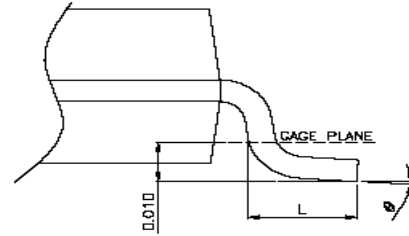
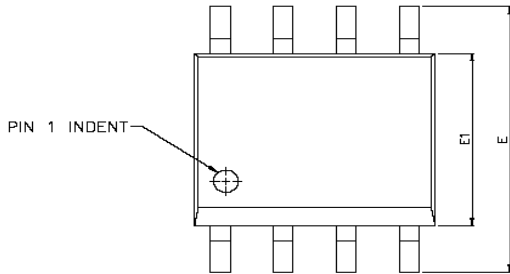

DETAIL A

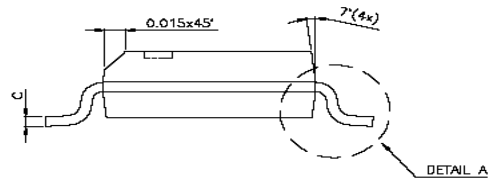
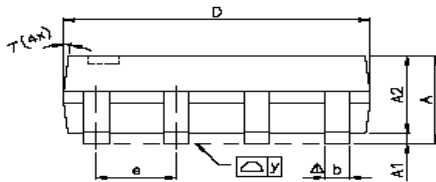

DETAIL A

SYMBOLS	DIMENSIONS IN MILLIMETERS			DIMENSIONS IN INCHES		
	MIN	NOM	MAX	MIN	NOM	MAX
A	1.47	1.60	1.73	0.058	0.063	0.068
A1	0.10	—	0.25	0.004	—	0.010
A2	—	1.45	—	—	0.057	—
b	0.33	0.41	0.51	0.013	0.016	0.020
C	0.19	0.20	0.25	0.0075	0.008	0.0098
D	4.80	4.85	4.95	0.189	0.191	0.195
E	5.80	6.00	6.20	0.228	0.236	0.244
E1	3.80	3.90	4.00	0.150	0.154	0.157
e	—	1.27	—	—	0.050	—
L	0.38	0.71	1.27	0.015	0.028	0.050
$\Delta$ y	—	—	0.076	—	—	0.003
$\theta$	0°	—	8°	0°	—	8°

©2010 Alfa-MOS Technology Corp.  
 2F, No.80, Sec.1, Cheng Kung Rd., Nan Kang Dist., Taipei City 115, Taiwan (R.O.C.)  
 Tel : 886 2) 2651 3928  
 Fax : 886 2) 2786 8483  
 ©http://www.alfa-mos.com