



**SPECIFICATION  
FOR  
LCD MODULE**

**MODULE NO: AFS320480TG-3.5-G010021  
REVISION NO: 00**

Customer's Approval:

--

	SIGNATURE	DATE
PREPARED BY (RD ENGINEER)	Alfred	2011-8-19
CHECKED BY	Fr. Li	2011-8-19
APPROVED BY	Sean	2011-8-19

## **DOCUMENT REVISION HISTORY**

<b>Version</b>	<b>DATE</b>	<b>DESCRIPTION</b>	<b>CHANGED BY</b>
00	Jun-08-2011	First Issue	lhm
01	Jul-29-2011	Changed “Dimensional Outline”	Fr.li
02	Aug-19-2011	Changed “Dimensional Outline”	Fr.li

## **CONTENTS**

<b>1. Features &amp; Mechanical specifications</b>	<b>1</b>
<b>2. Dimensional Outline</b>	<b>2</b>
<b>3. Block Diagram</b>	<b>3</b>
<b>4. Pin Description</b>	<b>4</b>
<b>5. Absolute Maximum Ratings</b>	<b>5</b>
<b>6. Electrical Characteristics</b>	<b>5</b>
<b>7. Backlight Specification</b>	<b>5</b>
<b>8. Electro-Optical Characteristics</b>	<b>6</b>
<b>9. Instruction Description</b>	<b>9</b>
<b>10. AC Characteristics</b>	<b>11</b>
<b>11. Quality Specification</b>	<b>12</b>

## 1. Features & Mechanical Specifications

Item	Contents	Unit
	LCD	
<b>LCD Type</b>	TFT / Transmissive / Normally Black	--
<b>Viewing direction</b>	Full viewing angle	--
<b>Backlight</b>	White LED x 6 in Parallel	--
<b>Interface</b>	8080-16bit parallel bus interface	--
<b>Driver IC</b>	ILI9481	--
<b>Outline Dimension</b>	54.48(W) × 84.71(H) × 1.95(T)	mm
<b>Glass area (W×H×T)</b>	53.36 × 76.84 / 81.64 × 0.3	mm
<b>Active area (W×H)</b>	48.96 × 73.44	mm
<b>Number of Dots</b>	320(RGB)×480	--
<b>Dot pitch (W×H)</b>	0.153 × 0.153	mm
<b>Pixel pitch (W×H)</b>	0.051 × 0.153	mm
<b>Operating Temperature</b>	-20 ~ +70	°C
<b>Storage temperature</b>	-30 ~ +80	°C

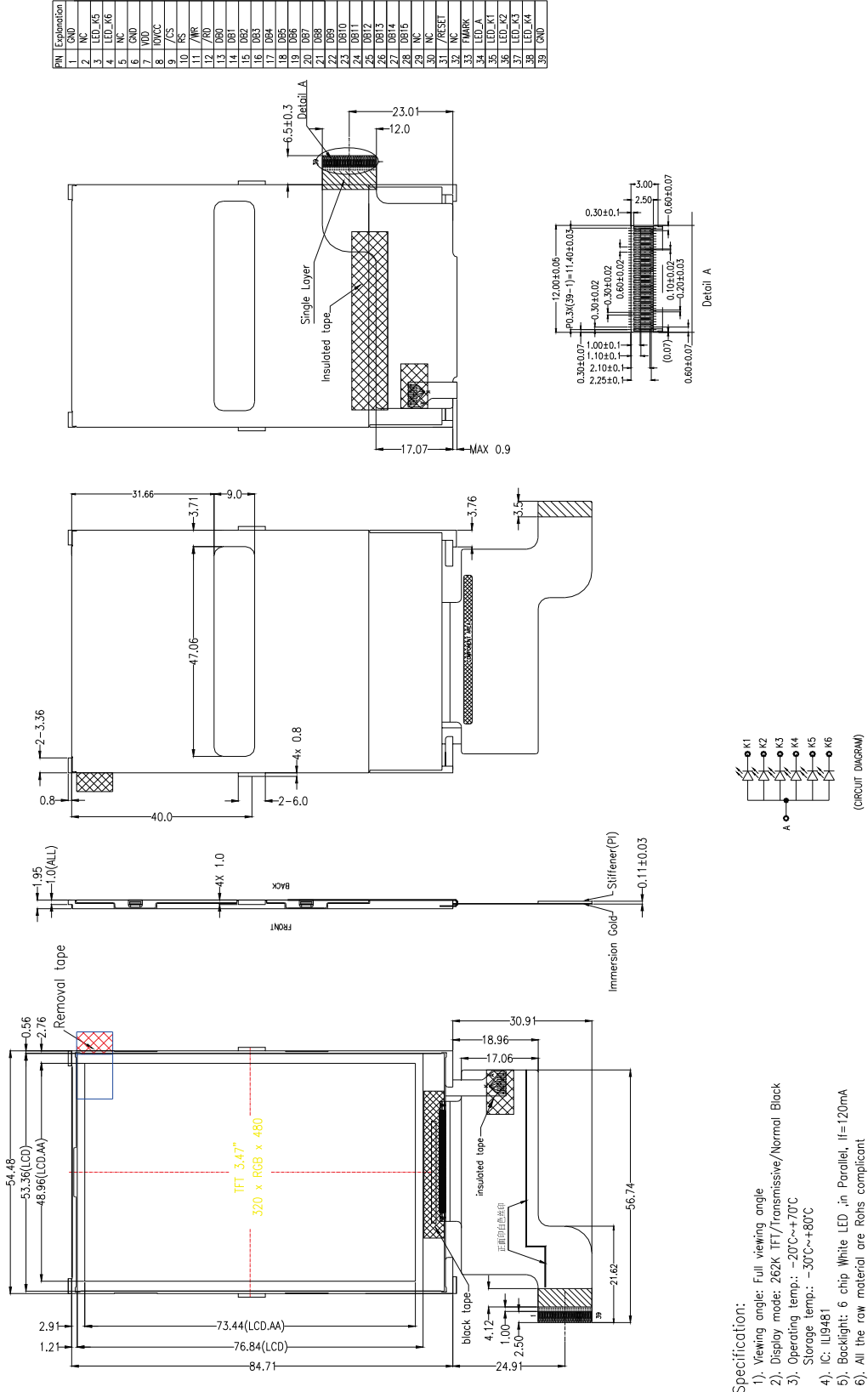

Figure 1. Dimensional outline

### 3. Block Diagram

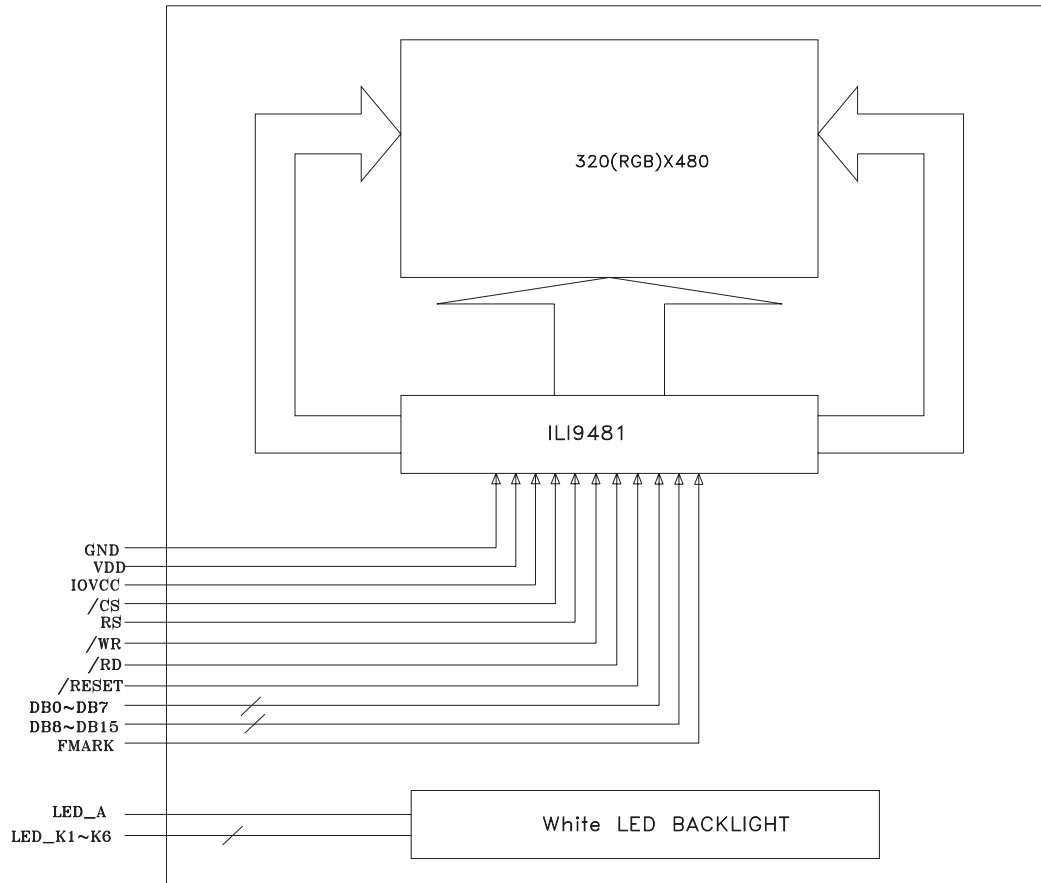

Figure 2. Block diagram

## 4. Pin Description

PIN No.	SYMBOL	Function
1	GND	Ground
2	NC	No Connection
3	LED_K5	LED5 Backlight Cathode
4	LED_K6	LED6 Backlight Cathode
5	NC	No Connection
6	GND	Ground
7	VDD	Analog Power Supply Voltage
8	IOVCC	I/O pin Power Supply Voltage
9	/CS	Chip select pin of serial interface
10	RS	Display data / command selection pin Low: command data High: display data
11	/WR	Write signal.
12	/RD	Read signal.
13~20	DB0~DB7	Data Bus
21~28	DB8~DB15	Data Bus
29~30	NC	No Connection
31	/RESET	System Reset Pin
32	NC	No Connection
33	FMARK	Tearing effect output pin
34	LED_A	LED Backlight Anode
35	LED_K1	LED1 Backlight Cathode
36	LED_K2	LED2 Backlight Cathode
37	LED_K3	LED3 Backlight Cathode
38	LED_K4	LED4 Backlight Cathode
39	GND	Ground

## **5. Absolute Maximum Ratings**

Item	Symbol	Rating	Unit
Power supply	VDD	-0.3 to +4.6	V
Power supply	IOVCC	-0.3 to +4.6	V
Operating Temperature range	TOP	-20 to +70	°C
Storage Temperature range	TST	-30 to +80	°C

## **6. Electrical Characteristics**

### **DC Characteristics**

Item	Symbol	Min.	Type.	Max.	Unit
Analog Power Supply Voltage	VDD	2.5	2.8	3.3	V
I/O pin Power Supply Voltage	IOVCC	1.65	2.8	3.3	V

## **7. Backlight Characteristics**

White LED × 6 in Parallel

(Ta = 25°C)

Item	Symbol	Condition	Min	Typ	Max	Unit
Forward Voltage	VF	IF=120mA	-	3.2	-	V
Uniformity	△Bp	-	80	-	-	%
Luminance for LCD	Lv	IF=120mA	4500	-	-	cd/m <sup>2</sup>



## 8. Electro-Optical Characteristics

Item	Symbol	Conditions	Specifications			Unit	Note
			Min.	Typ.	Max.		
Transmittance	T%	Viewing normal angle $\theta_x = \theta_y = 0^\circ$	-	5.0	-	%	All left side data are based on CMO's following condition – 1.CG : NTSC 70% (CIE1931) 2.LC : VA LC 3.Light Source : CMO LED BLU 4.Film : Circular polarizer 5.Machine : DMS 803 6.LC driving voltage: 5V
Contrast Ratio	CR		-	500	-		
Response Time (by Quick)	$T_R + T_F$		-	30	-	ms	
Viewing Angle	Hor.	$\theta_{x+}$	-	80	-	deg.	
		$\theta_{x-}$	-	80	-		
	Ver.	$\theta_{y+}$	-	80	-		
		$\theta_{y-}$	-	80	-		
CF only Chromaticity	Red	$X_R$	0.631	0.661	0.691	Under C light	
		$Y_R$	0.292	0.322	0.352		
	Green	$X_G$	0.247	0.277	0.307		
		$Y_G$	0.547	0.577	0.607		
	Blue	$X_B$	0.106	0.136	0.166		
		$Y_B$	0.073	0.103	0.133		
	White	$X_W$	0.260	0.290	0.320		
		$Y_W$	0.291	0.321	0.351		

\*Note (1) Definition of Contrast Ratio (CR):

The contrast ratio can be calculated by the following expression.

$$\text{Contrast Ratio (CR)} = L_{63} / L_0$$

L63: Luminance of gray level 63

L0: Luminance of gray level 0

$$CR = CR (5)$$

CR (X) is corresponding to the Contrast Ratio of the point X at Figure in Note (5).

\*Note (2) Definition of Response Time (TR, TF):

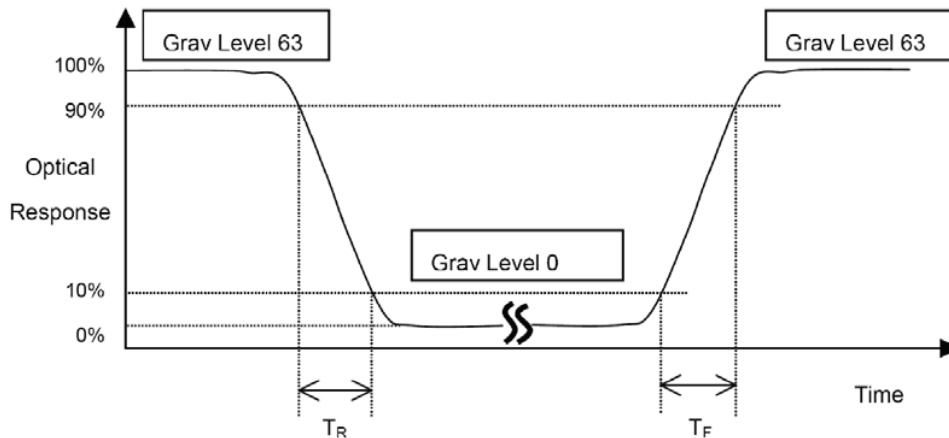

\*Note(3) Definition of Viewing Angle

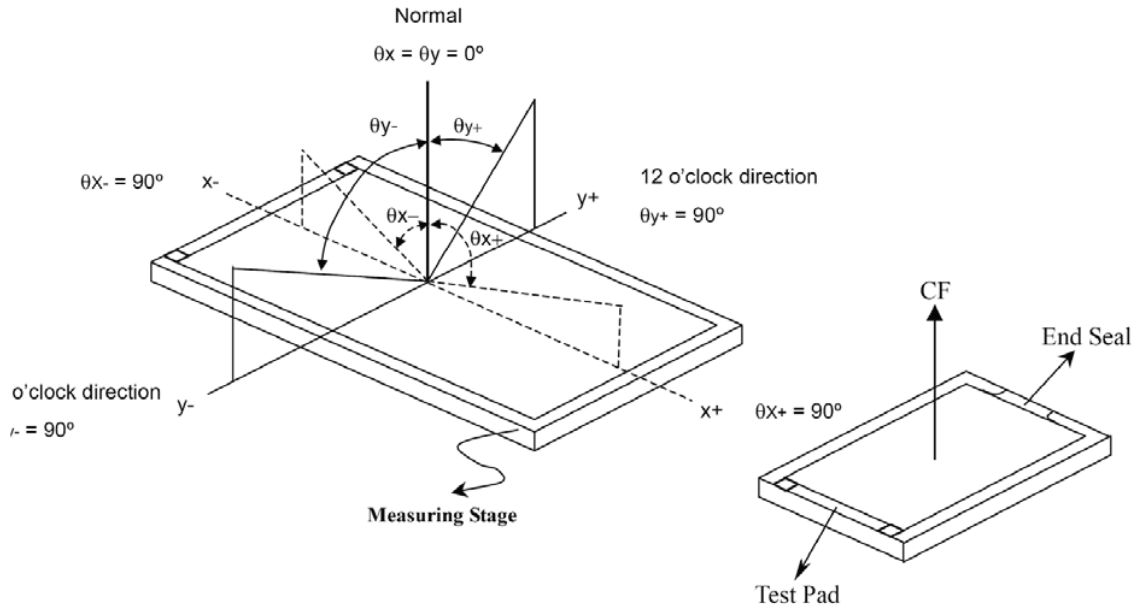

\*\*\* The above "Viewing Angle" is the measuring position with Largest Contrast Ratio; not for good image quality. View Direction for good image quality is Free. Module maker can increase the "Viewing Angle" by applying Wide View Film.

\*Note (4) Measurement Set-Up:

The LCD module should be stabilized at a given temperature for 20 minutes to avoid abrupt temperature change during measuring. In order to stabilize the luminance, the measurement should be executed after lighting Backlight for 20 minutes in a windless room.

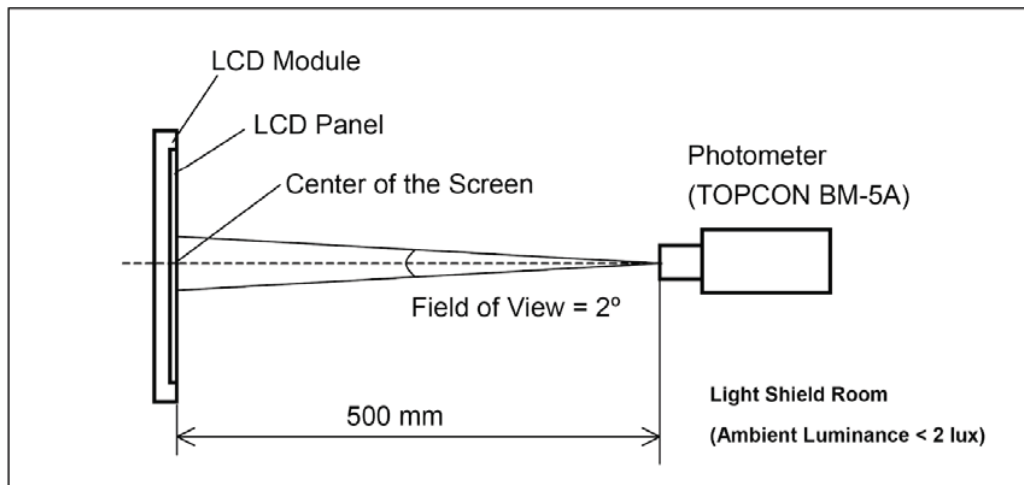

\*Note (5)

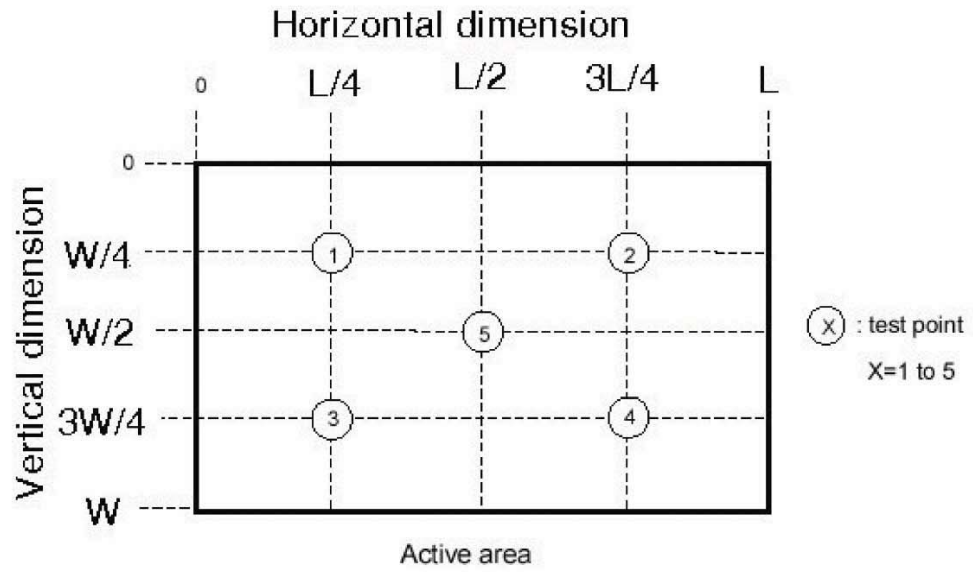

## 9. Instruction Description

Operational Code (Hex)	Command	Command(C) /Read(R) /Write(W)	Number Of Parameter	MIPI DCS Type1 Requirement	ILI9418 Implementation
00h	nop	C	0	Yes	Yes
01h	soft_reset	C	0	Yes	Yes
06h	get_red_channel	R	1	No	No
07h	get_green_channel	R	1	No	No
08h	get_blue_channel	R	1	No	No
0Ah	get_power_mode	R	1	Yes	Yes
0Bh	get_address_mode	R	1	Yes (Bit[7:0])	Yes (Bit[7:3]) , Only
0Ch	get_pixel_format	R	1	Yes	Yes
0Dh	get_display_mode	R	1	Yes	Yes
0Eh	get signal mode	R	1	Yes	Yes
0Fh	get_diagnostic_result	R	1	Bit7/6 : Yes Bit5/4 : Optional	Yes (Bit7/6 Only)
10h	enter_sleep_mode	C	0	Yes	Yes
11h	exit_sleep_mode	C	0	Yes	Yes
12h	enter_partial_mode	C	0	Yes	Yes
13h	enter_normal_mode	C	0	Yes	Yes
20h	exit_invert_mode	C	0	Yes	Yes
21h	enter_invert_mode	C	0	Yes	Yes
26h	set_gamma_curve	W	1	Yes	No
28h	set_display_off	C	0	Yes	Yes
29h	set_display_on	C	0	Yes	Yes
2Ah	set_column_address	W	4	Yes	Yes
2Bh	set_page_address	W	4	Yes	Yes
2Ch	write_memory_start	W	Variable	Yes	Yes
2Dh	wite LUT	W	Variable	Optional	No
2Eh	read_memory_start	R	Variable	Yes	Yes
30h	set_partial_area	W	4	Yes	Yes
33h	set_scroll_area	W	6	Yes	Yes
34h	set_tear_off	C	0	Yes	Yes
35h	set_tear_on	W	1	Yes	Yes
36h	set_address_mode	W	1	Yes (Bit7-0)	Yes (Bit[7:3], Bit[1:0] Only)
37h	set_scroll_start	W	2	Yes	Yes
38h	exit_idle_mode	C	0	Yes	Yes
39h	enter_idle_mode	C	0	Yes	Yes
3Ah	set_pixel_format	W	1	Yes	Yes
3Ch	write_memory_continue	W	Variable	Yes	Yes
3Eh	read_memory_continue	R	Variable	Yes	Yes
44h	set_tear_scanline	W	2	Yes	Yes
45h	get_scanline	R	2	Yes	Yes
A1h	read_DDB_start	R	5	Yes	Yes
A8h	read_DDB_continue	R	Variable	Yes	Yes

Operational Code (Hex)	Function	Command(C) Read(R)/Write(W)	Number Of Parameter
B0h	Command Access Protect	W/R	1
B1h	Low Power Mode Control	W/R	1
B3h	Frame Memory Access and Interface setting	W/R	5
B4h	Display Mode and Frame Memory Write Mode setting	W/R	1
BFh	Device code Read	R	4
C0h	Panel Driving Setting	W/R	7
C1h	Display Timing Setting for Normal Mode	W/R	3
C2h	Display Timing Setting for Partial Mode	W/R	3
C3h	Display Timing Setting for Idle Mode	W/R	3
C5h	Frame rate and Inversion Control	W/R	1
C6h	Interface Control	W/R	1
C8h	Gamma Setting	W/R	12
D0h	Power Setting	W/R	3
D1h	VCOM Control	W/R	3
D2h	Power Setting for Normal Mode	W/R	2
D3h	Power Setting for Partial Mode	W/R	2
D4h	Power Setting for Idle Mode	W/R	2
E0h	NV Memory Write	W/R	1
E1h	NV Memory Control	W/R	1
E2h	NV Memory Status	W/R	3
E3h	NV Memory Protection	W/R	2
B0~FF Except above command	LSI TEST Registers	W/R	Variable

## 10. AC Characteristics

DBI Type B (18/16/9/8 bit) Interface Timing Characteristics

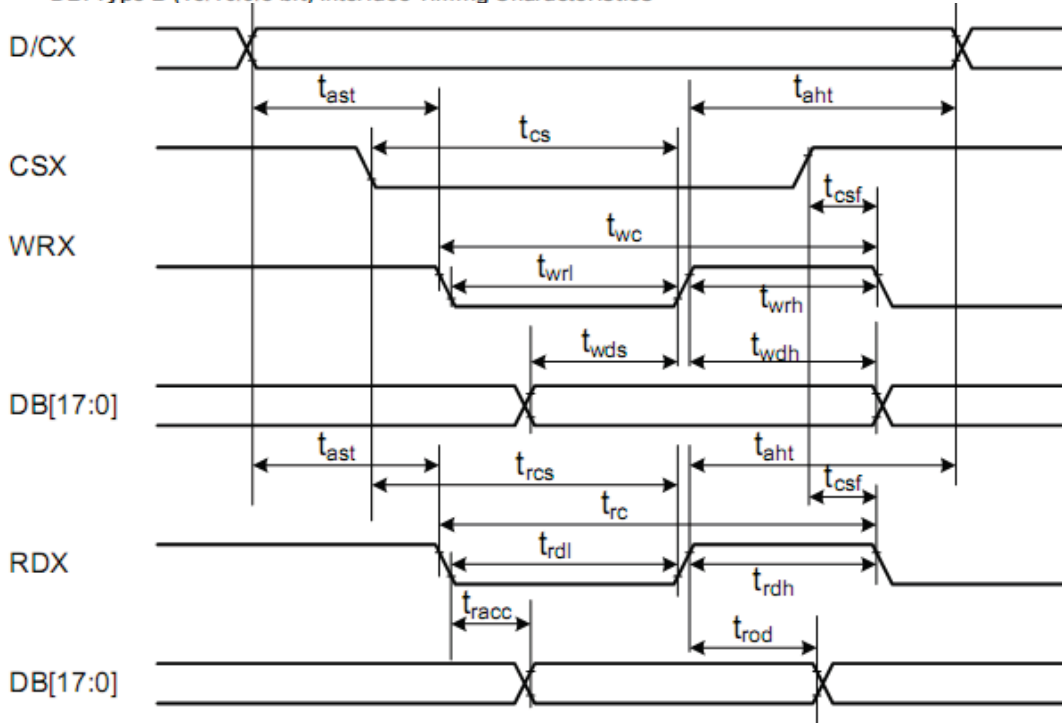

Signal	Symbol	Parameter	min	max	Unit	Description
D/CX	$t_{ast}$	Address setup time	10	-	ns	
	$t_{ah}$	Address hold time (Write/Read)	10	-	ns	
CSX	$t_{cs}$	Chip Select setup time (Write)	20	-	ns	
	$t_{rcs}$	Chip Select setup time (Read)	20	-	ns	
	$t_{csf}$	Chip Select Wait time (Write/Read)	20	-	ns	
WRX	$t_{wc}$	Write cycle	100	-	ns	
	$t_{wrh}$	Write Control pulse H duration	30	-	ns	
	$t_{wrl}$	Write Control pulse L duration	25	-	ns	
RDX	$t_{rc}$	Read cycle	450	-	ns	
	$t_{rdh}$	Read Control pulse H duration	250	-	ns	
	$t_{rdl}$	Read Control pulse L duration	170	-	ns	
DB[17:0], DB[15:0], DB[8:0], DB[7:0]	$t_{wds}$	Write data setup time	15	-	ns	For maximum CL=30pF For minimum CL=8pF
	$t_{wdh}$	Write data hold time	25	-	ns	
	$t_{racc}$	Read access time	10	340	ns	
	$t_{rod}$	Read output disable time	10	-	ns	

Note: Logic high and low levels are specified as 30% and 70% of IOVCC for Input signals.

Note:  $T_a = -30$  to  $70$  °C, IOVCC=1.65V to 3.3V, VCI=2.5V to 3.3V, GND=0V

## 11. Quality Specifications

All The raw material are Rohs compllicant.

### 11.1 Standard of the product appearance test

Manner of appearance test: The inspection should be performed in using 20W x 2 fluorecent lamps.

Distance between LCM and fluorecent lamps should be 100 cm or more. Distance between LCM and inspector eyes should be 30 cm or more.

Viewing direction for inspection is 45° from vertical against LCM.

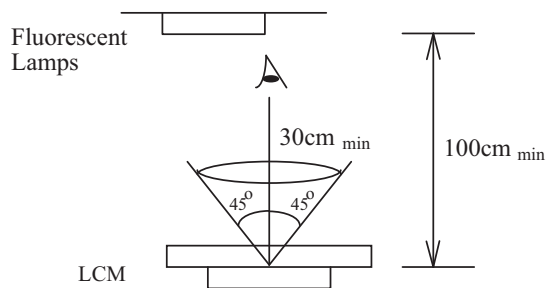

Definition of zone:

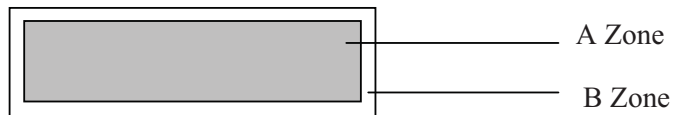

A Zone: viewing area

B Zone: outside viewing area

## 11.2 Specification of quality assurance

AQL inspection standard

Sampling method: MIL-STD-105E, Level II, single sampling

**Defect classification (Note: \* is not including)**

Classify	Item		Note	AQL
Major	Display state	Short or open circuit	1	0.65
		LC leakage		
		Flickering		
		No display		
		Wrong viewing direction		
		Contrast defect (dim, ghost)	2	
	Back-light	1,8		
	Non-display	Flat cable or pin reverse	10	
Wrong or missing component		11		
Minor	Display state	Background color deviation	2	1.0
		Black spot and dust	3	
		Line defect, Scratch	4	
		Rainbow	5	
		Chip	6	
		Pin hole	7	
	Polarizer	Protruded	12	
		Bubble and foreign material	3	
	Soldering	Poor connection	9	
	Wire	Poor connection	10	
	TAB	Position, Bonding strength	13	

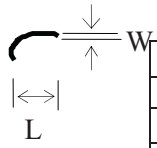

**Note on defect classification**

No.	Item	Criterion																				
1	Short or open circuit	Not allow																				
	LC leakage																					
	Flickering																					
	No display																					
	Wrong viewing direction																					
	Wrong Back-light																					
2	Contrast defect	Refer to approval sample																				
	Background color deviation																					
3	Point defect, Black spot, dust (including Polarizer)  $\phi = (X+Y)/2$	 <table border="1" data-bbox="901 903 1295 1171"> <thead> <tr> <th>Point Size</th> <th>Acceptable Qty.</th> </tr> </thead> <tbody> <tr> <td><math>\phi \leq 0.10</math></td> <td>Disregard</td> </tr> <tr> <td><math>0.10 &lt; \phi \leq 0.20</math></td> <td>3</td> </tr> <tr> <td><math>0.20 &lt; \phi \leq 0.25</math></td> <td>2</td> </tr> <tr> <td><math>0.25 &lt; \phi \leq 0.30</math></td> <td>1</td> </tr> <tr> <td><math>\phi &gt; 0.30</math></td> <td>0</td> </tr> </tbody> </table> <p>Unit: mm</p>	Point Size	Acceptable Qty.	$\phi \leq 0.10$	Disregard	$0.10 < \phi \leq 0.20$	3	$0.20 < \phi \leq 0.25$	2	$0.25 < \phi \leq 0.30$	1	$\phi > 0.30$	0								
Point Size	Acceptable Qty.																					
$\phi \leq 0.10$	Disregard																					
$0.10 < \phi \leq 0.20$	3																					
$0.20 < \phi \leq 0.25$	2																					
$0.25 < \phi \leq 0.30$	1																					
$\phi > 0.30$	0																					
4	Line defect, Scratch	 <table border="1" data-bbox="812 1333 1307 1591"> <thead> <tr> <th colspan="2">Line</th> <th>Acceptable Qty.</th> </tr> <tr> <th>L</th> <th>W</th> <th></th> </tr> </thead> <tbody> <tr> <td>---</td> <td><math>0.02 \geq W</math></td> <td>Disregard</td> </tr> <tr> <td><math>4.0 \geq L</math></td> <td><math>0.03 \geq W &gt; 0.02</math></td> <td rowspan="2">2</td> </tr> <tr> <td><math>2.0 \geq L</math></td> <td><math>0.05 \geq W &gt; 0.03</math></td> </tr> <tr> <td><math>1.0 \geq L</math></td> <td><math>0.1 &gt; W &gt; 0.05</math></td> <td>1</td> </tr> <tr> <td>---</td> <td><math>0.1 &lt; W</math></td> <td>Applied as point defect</td> </tr> </tbody> </table> <p>Unit: mm</p>	Line		Acceptable Qty.	L	W		---	$0.02 \geq W$	Disregard	$4.0 \geq L$	$0.03 \geq W > 0.02$	2	$2.0 \geq L$	$0.05 \geq W > 0.03$	$1.0 \geq L$	$0.1 > W > 0.05$	1	---	$0.1 < W$	Applied as point defect
Line		Acceptable Qty.																				
L	W																					
---	$0.02 \geq W$	Disregard																				
$4.0 \geq L$	$0.03 \geq W > 0.02$	2																				
$2.0 \geq L$	$0.05 \geq W > 0.03$																					
$1.0 \geq L$	$0.1 > W > 0.05$	1																				
---	$0.1 < W$	Applied as point defect																				
5	Rainbow	Not more than two color changes across the viewing area.																				

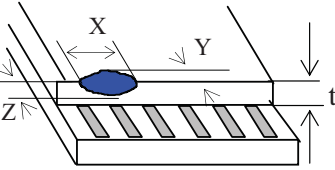
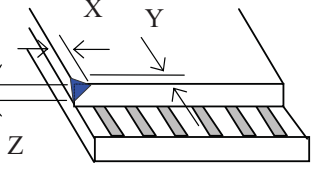
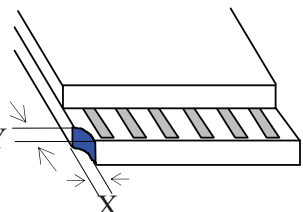
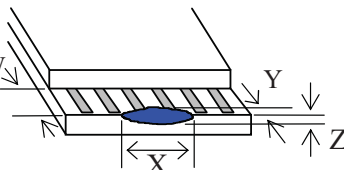
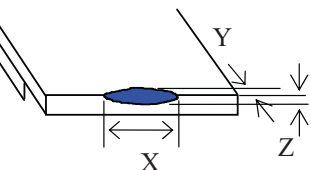
No	Item	Criterion																																	
6	<p>Chip</p> <p>Remark:  X: Length direction  Y: Short direction  Z: Thickness direction  t: Glass thickness  W: Terminal Width</p>	 <p>Acceptable criterion</p> <table border="1" data-bbox="966 436 1318 510"> <thead> <tr> <th>X</th> <th>Y</th> <th>Z</th> </tr> </thead> <tbody> <tr> <td><math>\leq 2</math></td> <td>0.5mm</td> <td><math>\leq t/2</math></td> </tr> </tbody> </table>  <p>Acceptable criterion</p> <table border="1" data-bbox="954 720 1318 793"> <thead> <tr> <th>X</th> <th>Y</th> <th>Z</th> </tr> </thead> <tbody> <tr> <td><math>\leq 2</math></td> <td>0.5mm</td> <td><math>\leq t</math></td> </tr> </tbody> </table>  <p>Acceptable criterion</p> <table border="1" data-bbox="971 987 1318 1092"> <thead> <tr> <th>X</th> <th>Y</th> <th>Z</th> </tr> </thead> <tbody> <tr> <td><math>\leq 3</math></td> <td><math>\leq 2</math></td> <td><math>\leq t</math></td> </tr> <tr> <td colspan="2">shall not reach to ITO</td> <td></td> </tr> </tbody> </table>  <p>Acceptable criterion</p> <table border="1" data-bbox="958 1333 1318 1407"> <thead> <tr> <th>X</th> <th>Y</th> <th>Z</th> </tr> </thead> <tbody> <tr> <td>Disregard</td> <td><math>\leq 0.2</math></td> <td><math>\leq t</math></td> </tr> </tbody> </table>  <p>Acceptable criterion</p> <table border="1" data-bbox="954 1591 1291 1665"> <thead> <tr> <th>X</th> <th>Y</th> <th>Z</th> </tr> </thead> <tbody> <tr> <td><math>\leq 5</math></td> <td><math>\leq 2</math></td> <td><math>\leq t/3</math></td> </tr> </tbody> </table>	X	Y	Z	$\leq 2$	0.5mm	$\leq t/2$	X	Y	Z	$\leq 2$	0.5mm	$\leq t$	X	Y	Z	$\leq 3$	$\leq 2$	$\leq t$	shall not reach to ITO			X	Y	Z	Disregard	$\leq 0.2$	$\leq t$	X	Y	Z	$\leq 5$	$\leq 2$	$\leq t/3$
X	Y	Z																																	
$\leq 2$	0.5mm	$\leq t/2$																																	
X	Y	Z																																	
$\leq 2$	0.5mm	$\leq t$																																	
X	Y	Z																																	
$\leq 3$	$\leq 2$	$\leq t$																																	
shall not reach to ITO																																			
X	Y	Z																																	
Disregard	$\leq 0.2$	$\leq t$																																	
X	Y	Z																																	
$\leq 5$	$\leq 2$	$\leq t/3$																																	

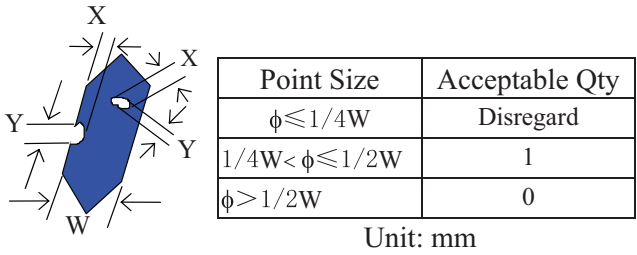
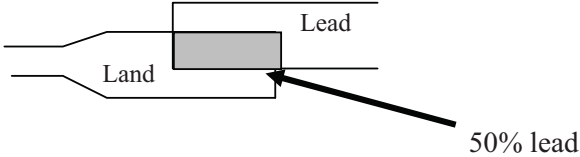
No.	Item	Criterion								
7	Segment pattern $W = \text{Segment width}$ $\phi = (X+Y)/2$	(1) Pin hole $\phi < 0.10\text{mm}$ is acceptable.  <table border="1" data-bbox="894 554 1310 716"> <thead> <tr> <th>Point Size</th> <th>Acceptable Qty</th> </tr> </thead> <tbody> <tr> <td><math>\phi \leq 1/4W</math></td> <td>Disregard</td> </tr> <tr> <td><math>1/4W &lt; \phi \leq 1/2W</math></td> <td>1</td> </tr> <tr> <td><math>\phi &gt; 1/2W</math></td> <td>0</td> </tr> </tbody> </table> <p style="text-align: center;">Unit: mm</p>	Point Size	Acceptable Qty	$\phi \leq 1/4W$	Disregard	$1/4W < \phi \leq 1/2W$	1	$\phi > 1/2W$	0
Point Size	Acceptable Qty									
$\phi \leq 1/4W$	Disregard									
$1/4W < \phi \leq 1/2W$	1									
$\phi > 1/2W$	0									
8	Back-light	(1) The color of backlight should correspond its specification. (2) Not allow flickering								
9	Soldering	(1) Not allow heavy dirty and solder ball on PCB. (The size of dirty refer to point and dust defect) (2) Over 50% of lead should be soldered on Land. 								
10	Wire	(1) Copper wire should not be rusted (2) Not allow crack on copper wire connection. (3) Not allow reversing the position of the flat cable. (4) Not allow exposed copper wire inside the flat cable.								
11*	PCB	(1) Not allow screw rust or damage. (2) Not allow missing or wrong putting of component.								

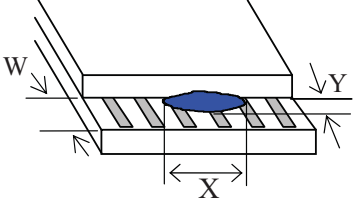
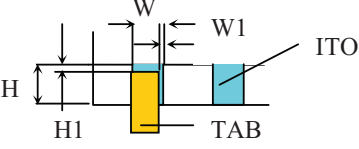
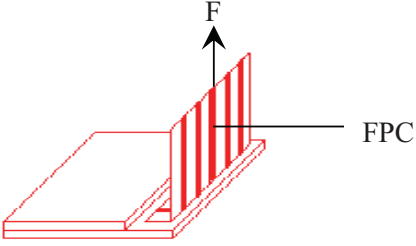
No	Item	Criterion
12	Protruded W: Terminal Width	 <p>Acceptable criteria: <math>Y \leq 0.4</math></p>
13	TAB	<p>1. Position</p>  <div style="border: 1px solid black; padding: 5px; width: fit-content; margin-left: auto; margin-right: auto;"> <math>W1 \leq 1/3W</math>  <math>H1 \leq 1/3H</math> </div> <p>2 FPC bonding strength test</p>  <p><math>P (=F/FPC \text{ bonding width}) \geq 650\text{gf/cm}</math> ,(speed rate: 1mm/min) 5pcs per SOA (shipment)</p>
14	Total no. of acceptable Defect	<p>A. Zone</p> <p>Maximum 2 minor non-conformities per one unit. Defect distance: each point to be separated over 10mm</p> <p>B. Zone</p> <p>It is acceptable when it is no trouble for quality and assembly in customer's end product.</p>

### 11.3 Reliability of LCM

Reliability test condition:

Item	Condition	Time (hrs)	Assessment
High temp. Storage	60°C	48	No abnormalities in functions and appearance
High temp. Operating	50°C	48	
Low temp. Storage	-10°C	48	
Low temp. Operating	0°C	48	
Humidity	40°C/ 90%RH	48	
Temp. Cycle	-10°C ← 25°C →60°C (60 min ← 5 min → 60min)	10cycles	

Recovery time should be 24 hours minimum. Moreover, functions, performance and appearance shall be free from remarkable deterioration within 50,000 hours under ordinary operating and storage conditions room temperature (20±8°C), normal humidity (below 65% RH), and in the area not exposed to direct sun light.

## 11.4 Precaution for using LCD/LCM

LCD/LCM is assembled and adjusted with a high degree of precision. Do not attempt to make any alteration or modification. The followings should be noted.

### General Precautions:

1. LCD panel is made of glass. Avoid excessive mechanical shock or applying strong pressure onto the surface of display area.
2. The polarizer used on the display surface is easily scratched and damaged. Extreme care should be taken when handling. To clean dust or dirt off the display surface, wipe gently with cotton, or other soft material soaked with isopropyl alcohol, ethyl alcohol or trichlorotrifluoroethane, do not use water, ketone or aromatics and never scrub hard.
3. Do not tamper in any way with the tabs on the metal frame.
4. Do not make any modification on the PCB without consulting Orient Display.
5. When mounting a LCM, make sure that the PCB is not under any stress such as bending or twisting. Elastomer contacts are very delicate and missing pixels could result from slight dislocation of any of the elements.
6. Avoid pressing on the metal bezel, otherwise the elastomer connector could be deformed and lose contact, resulting in missing pixels and also cause rainbow on the display.
7. Be careful not to touch or swallow liquid crystal that might leak from a damaged cell. Any liquid crystal adheres to skin or clothes, wash it off immediately with soap and water.

### Static Electricity Precautions:

1. CMOS-LSI is used for the module circuit; therefore operators should be grounded whenever he/she comes into contact with the module.
2. Do not touch any of the conductive parts such as the LSI pads; the copper leads on the PCB and the interface terminals with any parts of the human body.
3. Do not touch the connection terminals of the display with bare hand; it will cause disconnection or defective insulation of terminals.
4. The modules should be kept in anti-static bags or other containers resistant to static for storage.
5. Only properly grounded soldering irons should be used.
6. If an electric screwdriver is used, it should be grounded and shielded to prevent sparks.
7. The normal static prevention measures should be observed for work clothes and working benches.
8. Since dry air is inductive to static, a relative humidity of 50-60% is recommended.

**Soldering Precautions:**

1. Soldering should be performed only on the I/O terminals.
2. Use soldering irons with proper grounding and no leakage.
3. Soldering temperature:  $280^{\circ}\text{C}\pm 10^{\circ}\text{C}$
4. Soldering time: 3 to 4 second.
5. Use eutectic solder with resin flux filling.
6. If flux is used, the LCD surface should be protected to avoid spattering flux.
7. Flux residue should be removed.

**Operation Precautions:**

1. The viewing angle can be adjusted by varying the LCD driving voltage  $V_o$ .
2. Since applied DC voltage causes electro-chemical reactions, which deteriorate the display, the applied pulse waveform should be a symmetric waveform such that no DC component remains. Be sure to use the specified operating voltage.
3. Driving voltage should be kept within specified range; excess voltage will shorten display life.
4. Response time increases with decrease in temperature.
5. Display color may be affected at temperatures above its operational range.
6. Keep the temperature within the specified range usage and storage. Excessive temperature and humidity could cause polarization degradation, polarizer peel-off or generate bubbles.
7. For long-term storage over  $40^{\circ}\text{C}$  is required, the relative humidity should be kept below 60%, and avoid direct sunlight.

**Limited Warranty**

Orient Display LCDs and modules are not consumer products, but may be incorporated by Orient Display's customers into consumer products or components thereof, Orient Display does not warrant that its LCDs and components are fit for any such particular purpose.

1. The liability of Orient Display is limited to repair or replacement on the terms set forth below. Orient Display will not be responsible for any subsequent or consequential events or injury or damage to any personnel or user including third party personnel and/or user. Unless otherwise agreed in writing between Orient Display and the customer, Orient Display will only replace or repair any of its LCD which is found defective electrically or visually when inspected in accordance with Orient Display general LCD inspection standard. (Copies available on request)
2. No warranty can be granted if any of the precautions state in handling liquid crystal display above has been disregarded. Broken glass, scratches on polarizer mechanical damages as well as defects that are caused accelerated environment tests are excluded from warranty.
3. In returning the LCD/LCM, they must be properly packaged; there should be detailed description of the failures or defect.