

Product Features

- 60 – 3000 MHz
- 14 dB Gain
- 2.4 dB Noise Figure
- +36 dBm OIP3
- Single +3.3 or +4.5 Supply
- Internally matched to 50 Ω
- Lead-free/Green/RoHS-compliant SOT-89 Package
- MTTF > 1000 years

Applications

- Mobile Infrastructure
- CATV / DBS
- W-LAN / ISM
- RFID
- Defense / Homeland Security
- Fixed Wireless

Product Description

The AG102 is a general-purpose gain block that offers good dynamic range and low noise figure in a low-cost surface-mount package. The combination of near-constant OIP3 and low noise figure performance over frequency makes it attractive for both narrowband and broadband applications. The device combines dependable performance with superb quality to maintain MTTF values exceeding 1000 years at mounting temperatures of +85 °C and is available in the environmentally-friendly lead-free/green /RoHS-compliant SOT-89 package.

The AG102 uses a high reliability GaAs MMIC technology and only requires DC-blocking and bypass capacitors, and an inductive RF choke for operation. Internal matching provides a 50 ohm input / output impedance minimizing the number of required external components.

The broadband MMIC amplifier is well suited for various current and next generation wireless technologies such as GPRS, GSM, CDMA, and W-CDMA. In addition, the AG102 will work for other applications within the 60 to 3000 MHz frequency range such as fixed wireless.

Functional Diagram

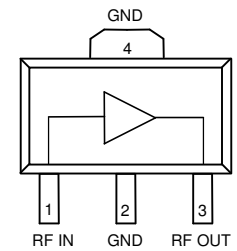

Function	Pin No.
Input	1
Output/Bias	3
Ground	2, 4

Specifications ⁽¹⁾

Parameter	Units	Min	Typ	Max
Operational Bandwidth	MHz	60		3000
Test Frequency	MHz		800	
Gain	dB	13	14	16
Input Return Loss ⁽⁵⁾	dB		8.5	
Output Return Loss	dB		20	
Output P1dB	dBm		+18	
Output IP3 ⁽²⁾	dBm	+33	+36	
Noise Figure ⁽³⁾	dB		2.4	
Operating Current Range	mA	55	70	90
Supply Voltage	V		4.5	

1. Test conditions unless otherwise noted: T = 25° C, 50 Ω system.
2. 3OIP measured with two tones at an output power of +2.5 dBm/tone separated by 10 MHz. The suppression on the largest IM3 product is used to calculate the 3OIP using a 2:1 rule.
3. Noise figure can be optimized by matching the input for optimal return loss.

Typical Performance ⁽⁴⁾

Parameter	Units	Typical			
		900	1900	900	1900
Frequency	MHz	900	1900	900	1900
S21	dB	14	12.8	14	12.5
S11 ⁽⁵⁾	dB	-10	-9	-10	-9
S22	dB	-27	-22	-28	-19
Output P1dB	dBm	+18	+18	+16	+16
Output IP3	dBm	+36	+36	+35	+35
Noise Figure	dB	2.4	2.6	2.3	2.6
Supply Voltage	V	+4.5		+3.3	
Device Current	mA	70		68	

4. Parameters reflect performance in an AG102-PCB application circuit, as shown on page 4.
5. Input return loss can be dramatically improved (<-20 dB) for narrowband applications as shown on page 5 of this datasheet.

Absolute Maximum Rating

Parameter	Rating
Operating Case Temperature	-40 to +85 °C
Storage Temperature	-55 to +150 °C
DC Voltage	+5.5 V
RF Input Power (continuous)	+6 dBm
Junction Temperature	+220 °C

Operation of this device above any of these parameters may cause permanent damage.

Ordering Information

Part No.	Description
AG102-G	High Dynamic Range Gain Block (lead-free/green/RoHS-compliant SOT-89 Pkg)
AG102-PCB	0.8 – 2.6 GHz Fully Assembled Application Circuit

Specifications and information are subject to change without notice.



Typical Device Data

S-Parameters ($V_{DS} = +4.5\text{ V}$, $I_{DS} = 70\text{ mA}$, $T = 25\text{ }^\circ\text{C}$, 50 ohm system)

Input return loss can be improved with the appropriate input matching network shown later in this datasheet.

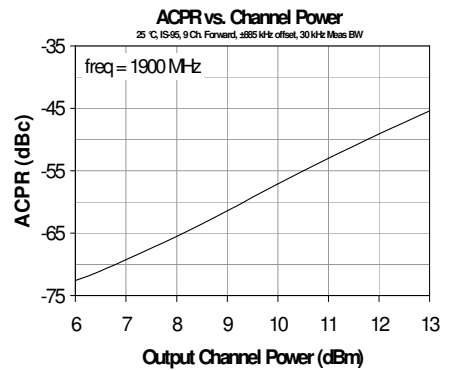
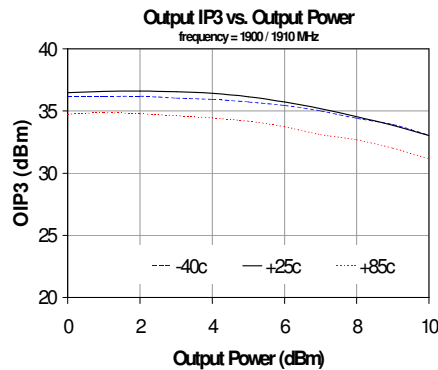
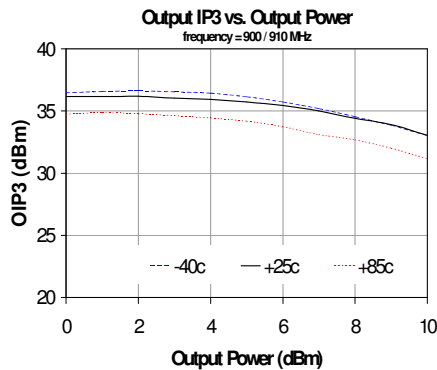
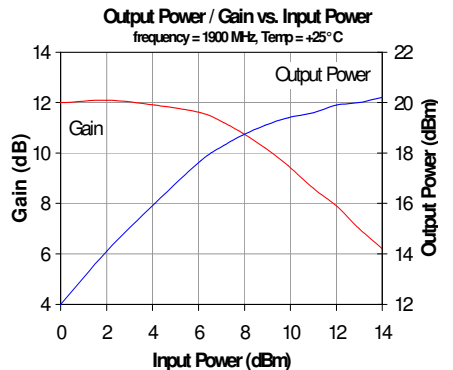
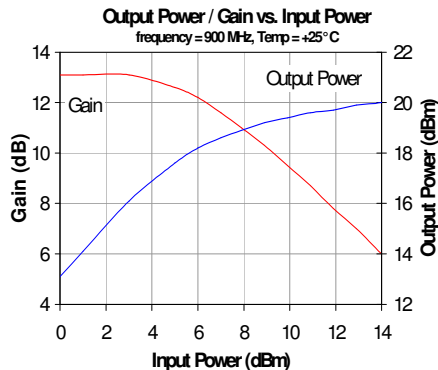
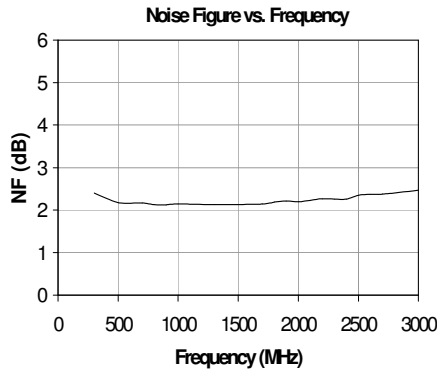
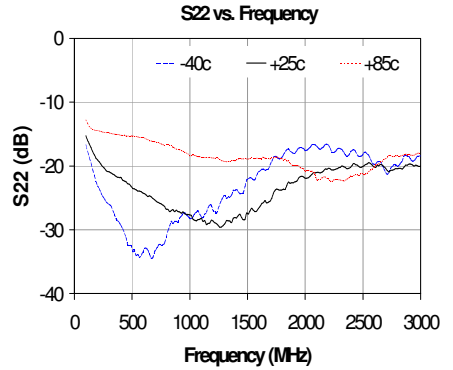
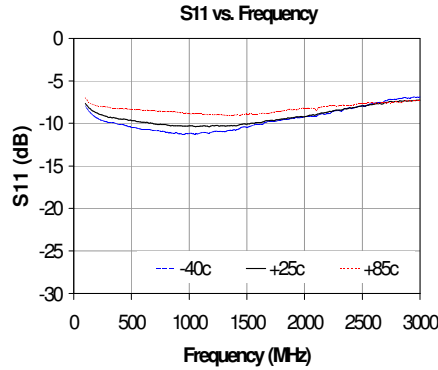
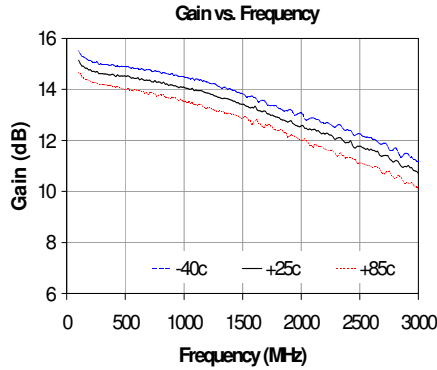

S-Parameters ($V_D = +4.5\text{ V}$, $I_D = 78\text{ mA}$, $T = 25\text{ }^\circ\text{C}$, calibrated to device leads)

Freq (MHz)	S11 (dB)	S11 (ang)	S21 (dB)	S21 (ang)	S12 (dB)	S12 (ang)	S22 (dB)	S22 (ang)
50	-4.72	-30.88	15.44	164.91	-21.66	30.26	-9.38	-40.39
250	-8.67	-27.48	13.93	165.39	-20.26	3.92	-16.70	-32.88
500	-8.96	-37.68	13.75	157.18	-20.14	-2.25	-17.56	-31.25
750	-9.06	-51.15	13.60	148.11	-20.02	-7.65	-18.25	-35.67
1000	-9.04	-66.87	13.47	137.91	-19.92	-10.63	-19.05	-43.62
1250	-9.00	-82.11	13.39	128.62	-19.85	-15.19	-20.28	-51.49
1500	-8.89	-97.31	13.13	118.57	-19.73	-18.74	-21.30	-61.37
1750	-8.74	-112.48	12.91	109.09	-19.56	-23.00	-22.57	-73.75
2000	-8.65	-128.51	12.68	99.48	-19.71	-28.33	-25.15	-85.19
2250	-8.40	-142.86	12.48	89.94	-19.53	-33.37	-27.03	-103.19
2500	-7.99	-157.26	12.22	80.41	-19.40	-37.91	-28.58	-135.19
2750	-7.93	-171.48	11.88	71.42	-19.33	-42.30	-28.56	-177.83
3000	-7.47	175.92	11.53	62.05	-19.58	-47.37	-28.48	153.84



Typical Device Data

S-Parameters ($V_{DS} = +3.3\text{ V}$, $I_{DS} = 68\text{ mA}$, $T = 25\text{ }^\circ\text{C}$, 50 ohm system)

Input return loss can be improved with the appropriate input matching network shown later in this datasheet.

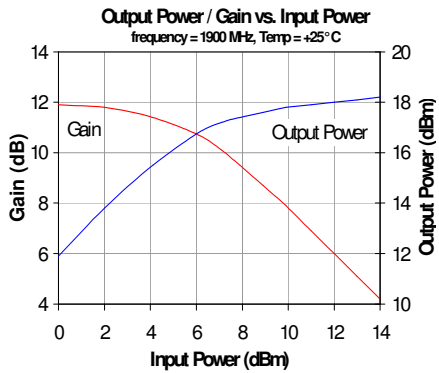
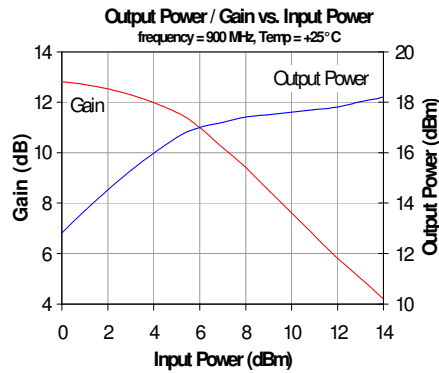
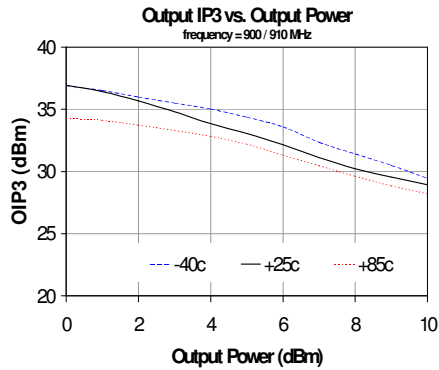
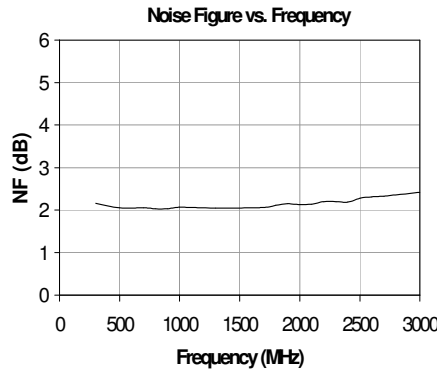
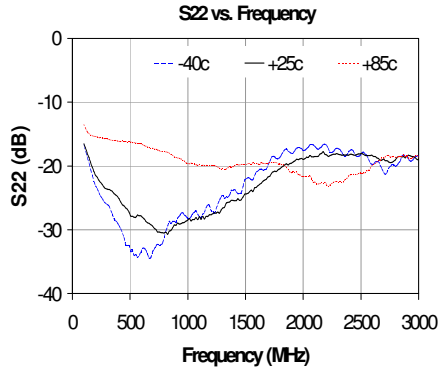
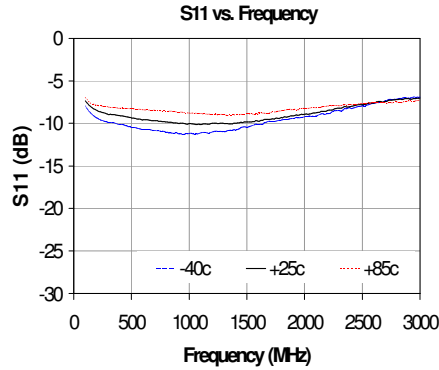
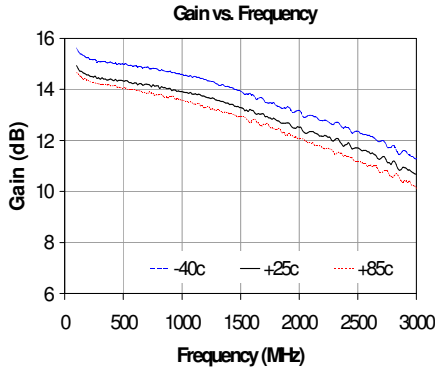



AG102

High Dynamic Range Gain Block

Application Circuit: 800 – 2600 MHz (AG102-PCB)

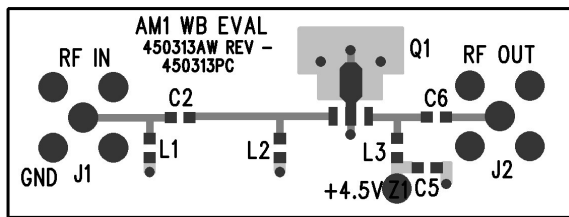
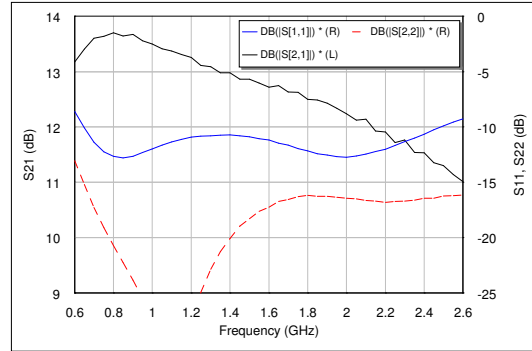
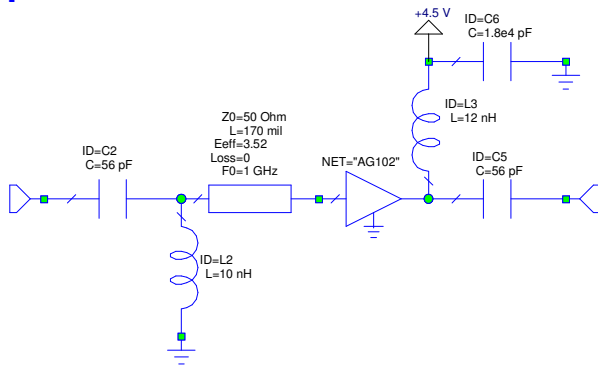

Circuit Board Material: .014" FR-4, 4 layers, .062" total thickness

Reference Design: 70 MHz

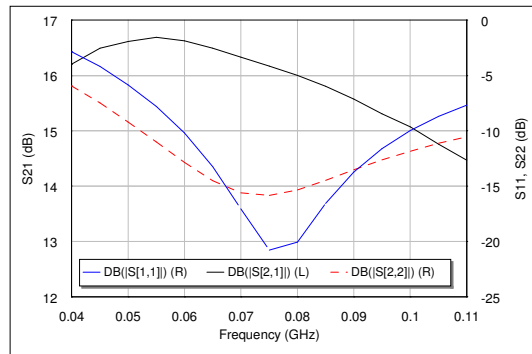
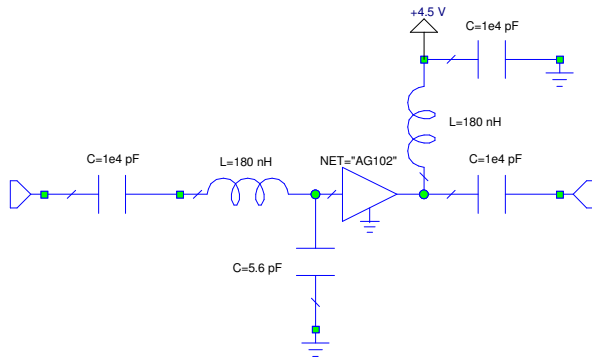

Reference Design: 170 MHz

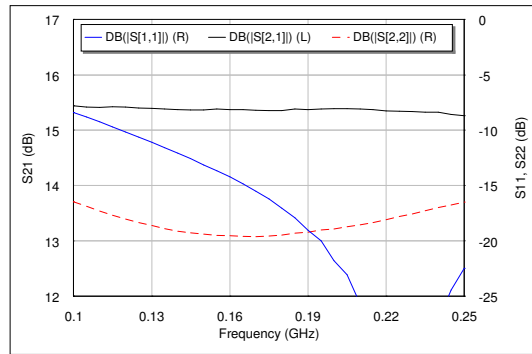
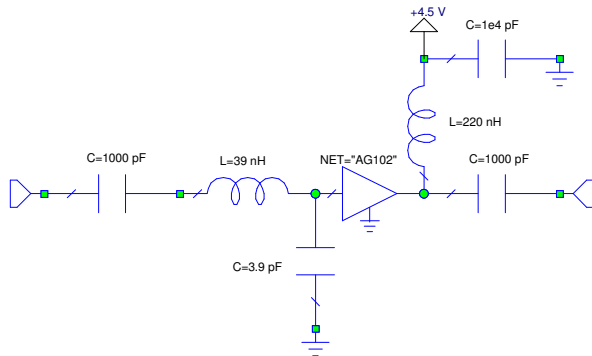



Reference Design: 450 MHz

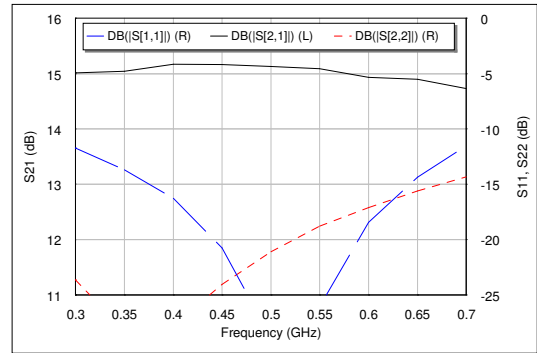
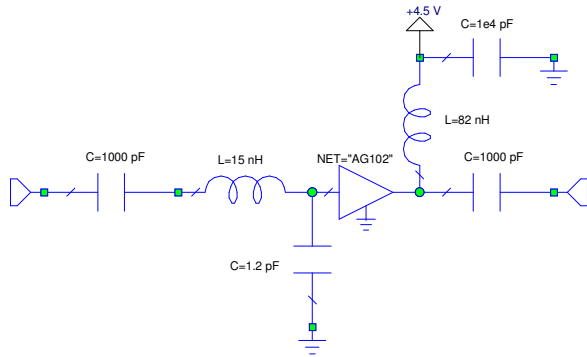

Reference Design: 800 MHz

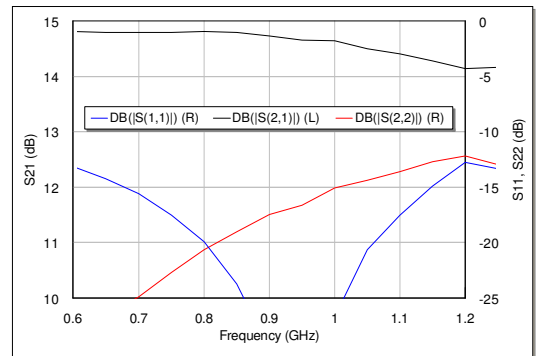
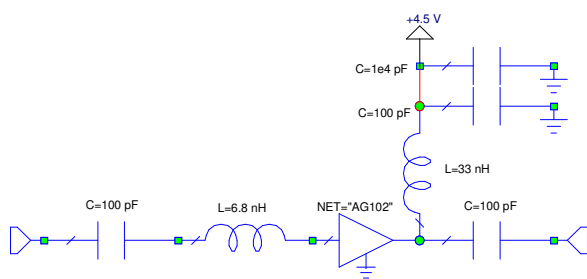

Reference Design: 1900 / 2140 MHz

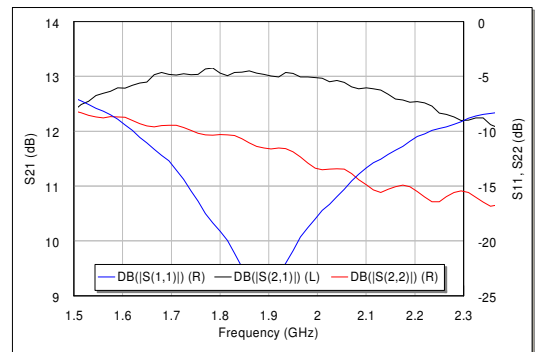
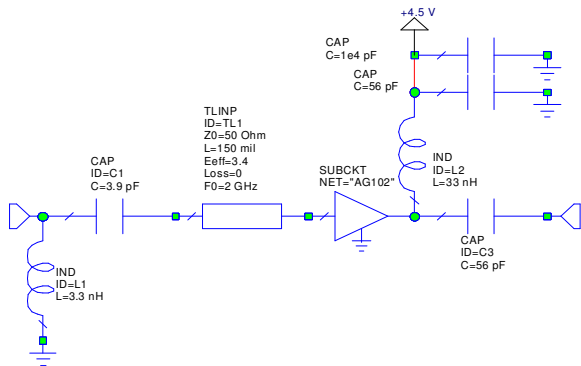

Reference Design: CATV Single-ended Operation

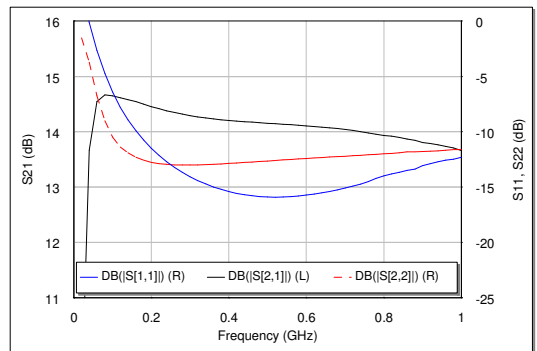
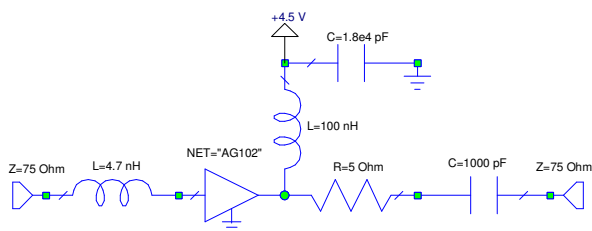

Specifications and information are subject to change without notice.

AG102-G (Green / Lead-free SOT-89 Package) Mechanical Information

This package is lead-free/Green/RoHS-compliant. It is compatible with both lead-free (maximum 260 °C reflow temperature) and leaded (maximum 245 °C reflow temperature) soldering processes. The plating material on the leads is NiPdAu.

Outline Drawing

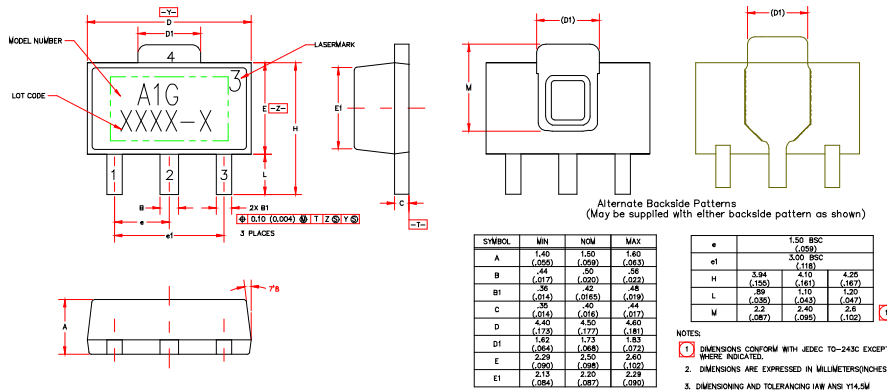

Product Marking

The AG102-G will be marked with an "A1G" designator. An alphanumeric lot code ("XXXX-X") is also marked below the part designator on the top surface of the package. A "3" will be lasermarked in the upper right-hand corner. The obsolete tin-lead package is marked with an "A1" designator followed by an alphanumeric lot code.

Tape and reel specifications for this part are located on the website in the "Application Notes" section.

MSL / ESD Rating



Caution! ESD sensitive device.

ESD Rating: Class 1B
 Value: Passes $\geq 500V$ to $<1000V$
 Test: Human Body Model (HBM)
 Standard: JEDEC Standard JESD22-A114

ESD Rating: Class IV
 Value: Passes $\geq 1000V$ to $<2000V$
 Test: Charged Device Model (CDM)
 Standard: JEDEC Standard JESD22-C101

MSL Rating: Level 3 at $+260^\circ C$ convection reflow
 Standard: JEDEC Standard J-STD-020

Land Pattern

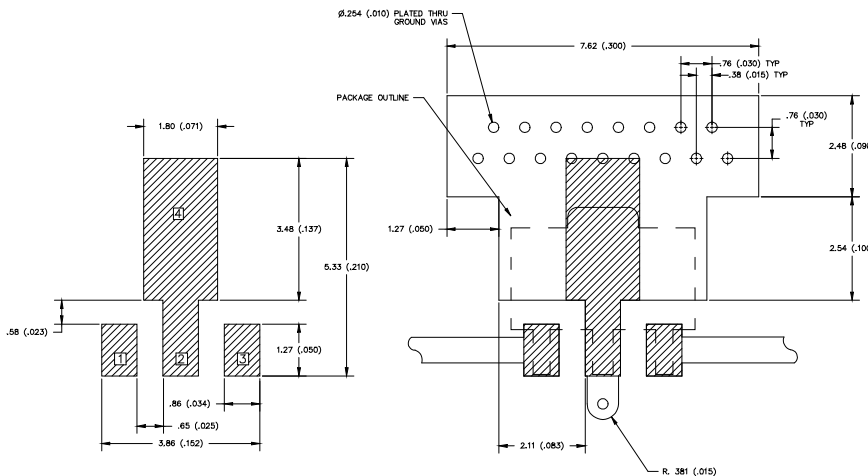

Thermal Specifications

Parameter	Rating
Operating Case Temperature	-40 to +85 °C
Thermal Resistance, Rth ⁽¹⁾	88 °C/W
Junction Temperature, Tj ⁽²⁾	113 °C

- The thermal resistance is referenced from the hottest part of the junction to the ground tab (pin 4).
- This corresponds to the typical biasing condition of +5V, 70 mA at an 85°C case temperature. A minimum MTTF of 1 million hours is achieved for junction temperatures below 160 °C.

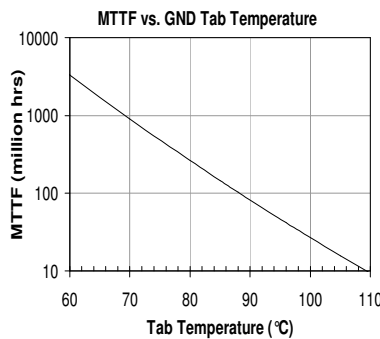

Mounting Config. Notes

- Ground / thermal vias are critical for the proper performance of this device. Vias should use a .35mm (#80 / .0135") diameter drill and have a final plated thru diameter of .25 mm (.010").
- Add as much copper as possible to inner and outer layers near the part to ensure optimal thermal performance.
- Mounting screws can be added near the part to fasten the board to a heatsink. Ensure that the ground / thermal via region contacts the heatsink.
- Do not put solder mask on the backside of the PC board in the region where the board contacts the heatsink.
- RF trace width depends upon the PC board material and construction.
- Use 1 oz. Copper minimum.
- All dimensions are in millimeters (inches). Angles are in degrees.