

# AG303-86

## InGaP HBT Gain Block



### Product Features

- DC – 6000 MHz
- 20.5 dB Gain @ 900 MHz
- +14 dBm P1dB @ 900 MHz
- +26 dBm OIP3 @ 900 MHz
- Single Voltage Supply
- Internally matched to 50 Ω
- Robust 1000V ESD, Class 1C
- Lead-free/RoHS-compliant SOT-86 package

### Applications

- Mobile Infrastructure
- CATV / FTTH
- WLAN / ISM
- RFID
- WiMAX / WiBro

### Product Description

The AG303-86 is a general-purpose buffer amplifier that offers high dynamic range in a low-cost surface-mount package. At 900 MHz, the AG303-86 typically provides 20.5 dB gain, +26 dBm OIP3, and +14 dBm P1dB. The device combines dependable performance with consistent quality to maintain MTTF values exceeding 1000 years at mounting temperatures of +85 °C and is housed in a lead-free/RoHS-compliant SOT-86 (micro-X) industry-standard SMT package.

The AG303-86 consists of a Darlington-pair amplifier using the high reliability InGaP/GaAs HBT process technology and only requires DC-blocking capacitors, a bias resistor, and an inductive RF choke for operation.

The broadband MMIC amplifier can be directly applied to various current and next generation wireless technologies such as GPRS, GSM, CDMA, and W-CDMA. In addition, the AG303-86 will work for other various applications within the DC to 6 GHz frequency range such as CATV and WiMAX.

### Functional Diagram

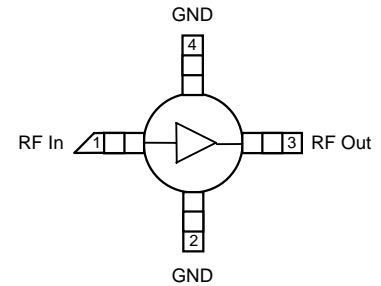

| Function    | Pin No. |
|-------------|---------|
| Input       | 1       |
| Output/Bias | 3       |
| Ground      | 2, 4    |

### Specifications <sup>(1)</sup>

| Parameter                 | Units | Min  | Typ   | Max  |
|---------------------------|-------|------|-------|------|
| Operational Bandwidth     | MHz   | DC   |       | 6000 |
| Test Frequency            | MHz   |      | 900   |      |
| Gain                      | dB    |      | 20.4  |      |
| Input Return Loss         | dB    |      | 22    |      |
| Output Return Loss        | dB    |      | 20    |      |
| Output P1dB               | dBm   |      | +14   |      |
| Output IP3 <sup>(2)</sup> | dBm   |      | +26.1 |      |
| Output IP2                | dBm   |      | +34   |      |
| Noise Figure              | dB    |      | 3     |      |
| Test Frequency            | MHz   |      | 1900  |      |
| Gain                      | dB    | 16.9 | 18.1  | 18.9 |
| Output P1dB               | dBm   |      | +12.7 |      |
| Output IP3 <sup>(2)</sup> | dBm   |      | +24.8 |      |
| Device Voltage            | V     |      | 4.23  |      |
| Device Current            | mA    |      | 35    |      |

1. Test conditions: T = 25 °C, Supply Voltage = +5 V, R<sub>bias</sub> = 22.1 Ω, 50 Ω System.  
 2. 3OIP measured with two tones at an output power of -2 dBm/tone separated by 10 MHz. The suppression on the largest IM3 product is used to calculate the 3OIP using a 2:1 rule.

### Typical Performance <sup>(1)</sup>

| Parameter    | Units | Typical |       |       |       |
|--------------|-------|---------|-------|-------|-------|
| Frequency    | MHz   | 500     | 900   | 1900  | 2140  |
| S21          | dB    | 21.1    | 20.4  | 18.1  | 17.5  |
| S11          | dB    | -21     | -22   | -26   | -25   |
| S22          | dB    | -22     | -20   | -16   | -16   |
| Output P1dB  | dBm   | +14.0   | +14.0 | +12.7 | +12.4 |
| Output IP3   | dBm   | +26.4   | +26.1 | +24.8 | +24.4 |
| Noise Figure | dB    | 2.9     | 3.0   | 3.2   | 3.2   |

### Absolute Maximum Rating

| Parameter                           | Rating         |
|-------------------------------------|----------------|
| Storage Temperature                 | -55 to +125 °C |
| DC Voltage                          | +5 V           |
| RF Input Power (continuous)         | +10 dBm        |
| Thermal Resistance, R <sub>th</sub> | 335°C/W        |
| Junction Temperature                | +177°C         |

Operation of this device above any of these parameters may cause permanent damage.

### Ordering Information

| Part No.    | Description   |
|-------------|---|
| AG303-86G   | InGaP HBT Gain Block<br>(lead-free/RoHS-compliant SOT-86 Package) |
| AG303-86PCB | 700 – 2400 MHz Fully Assembled Eval. Board                        |

Standard tape / reel size = 3000 pieces on a 13" reel

### Typical Device RF Performance Supply Bias = +5 V, $R_{bias} = 22.1 \Omega$ , $I_{cc} = 35 \text{ mA}$

| Frequency    | MHz | 100   | 500   | 900   | 1900  | 2140  | 2400  | 3500 | 5800 |
|--------------|-----|-------|-------|-------|-------|-------|-------|------|------|
| S21          | dB  | 21.4  | 21.1  | 20.4  | 18.1  | 17.5  | 16.9  | 14.9 | 11.4 |
| S11          | dB  | -25   | -21   | -22   | -26   | -25   | -25   | -25  | -25  |
| S22          | dB  | -19   | -22   | -20   | -16   | -16   | -15   | -15  | -14  |
| Output P1dB  | dBm | +14.2 | +14.0 | +14.0 | +12.7 | +12.4 | +12.1 | +9.3 |      |
| Output IP3   | dBm | +26.5 | +26.4 | +26.1 | +24.8 | +24.4 | +23.9 |      |      |
| Noise Figure | dB  | 2.9   | 2.9   | 3.0   | 3.2   | 3.2   | 3.2   |      |      |

1. Test conditions: T = 25 °C, Supply Voltage = +5 V, Device Voltage = 4.23 V,  $R_{bias} = 22.1 \Omega$ ,  $I_{cc} = 35 \text{ mA}$  typical, 50  $\Omega$  System.
2. 3OIP measured with two tones at an output power of -2 dBm/tone separated by 10 MHz. The suppression on the largest IM3 product is used to calculate the 3OIP using a 2:1 rule.
3. Data is shown as device performance only. Actual implementation for the desired frequency band will be determined by external components shown in the application circuit.

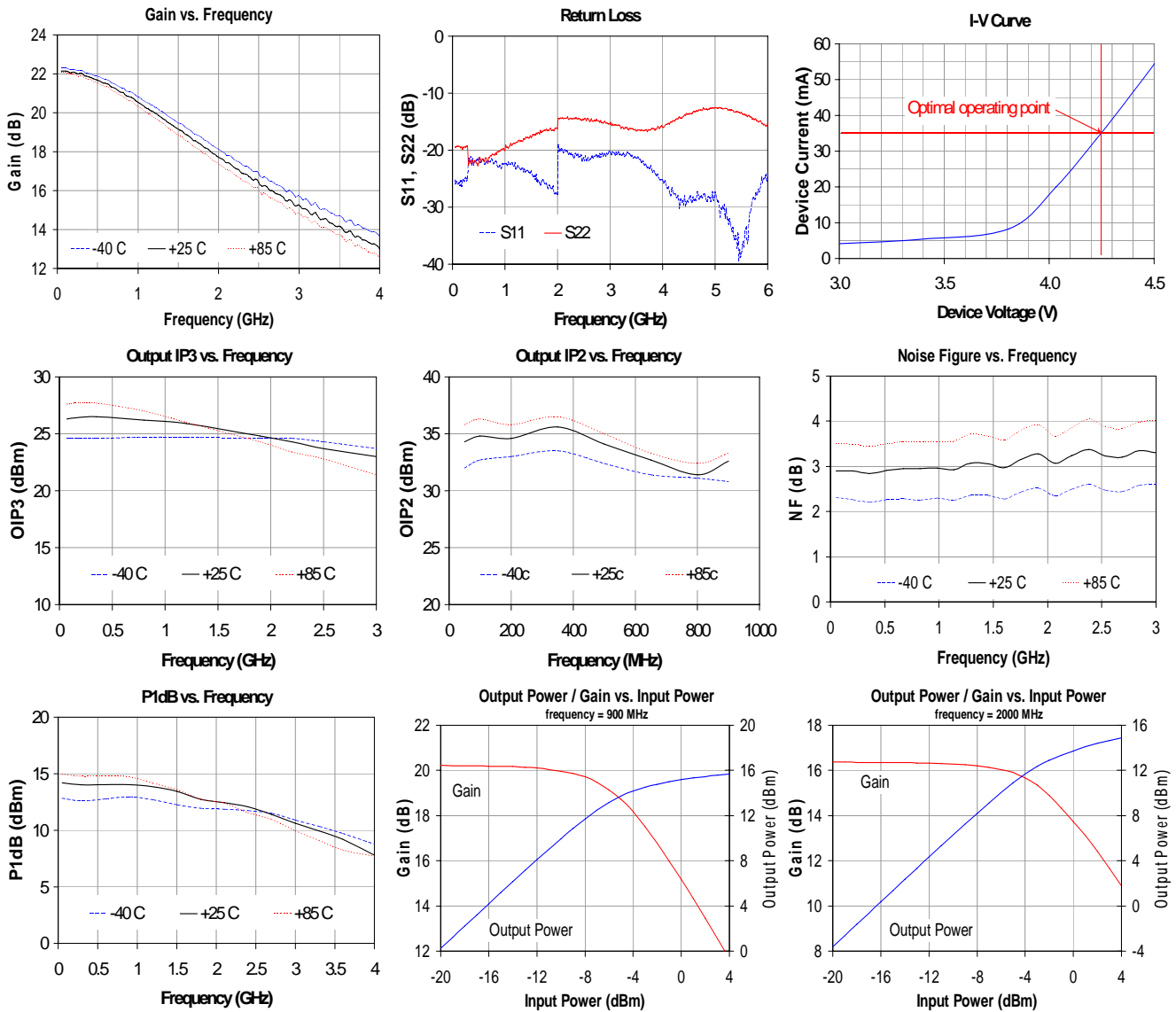

### Typical Device RF Performance (cont'd)

Supply Bias = +6 V,  $R_{bias} = 51 \Omega$ ,  $I_{cc} = 35 \text{ mA}$

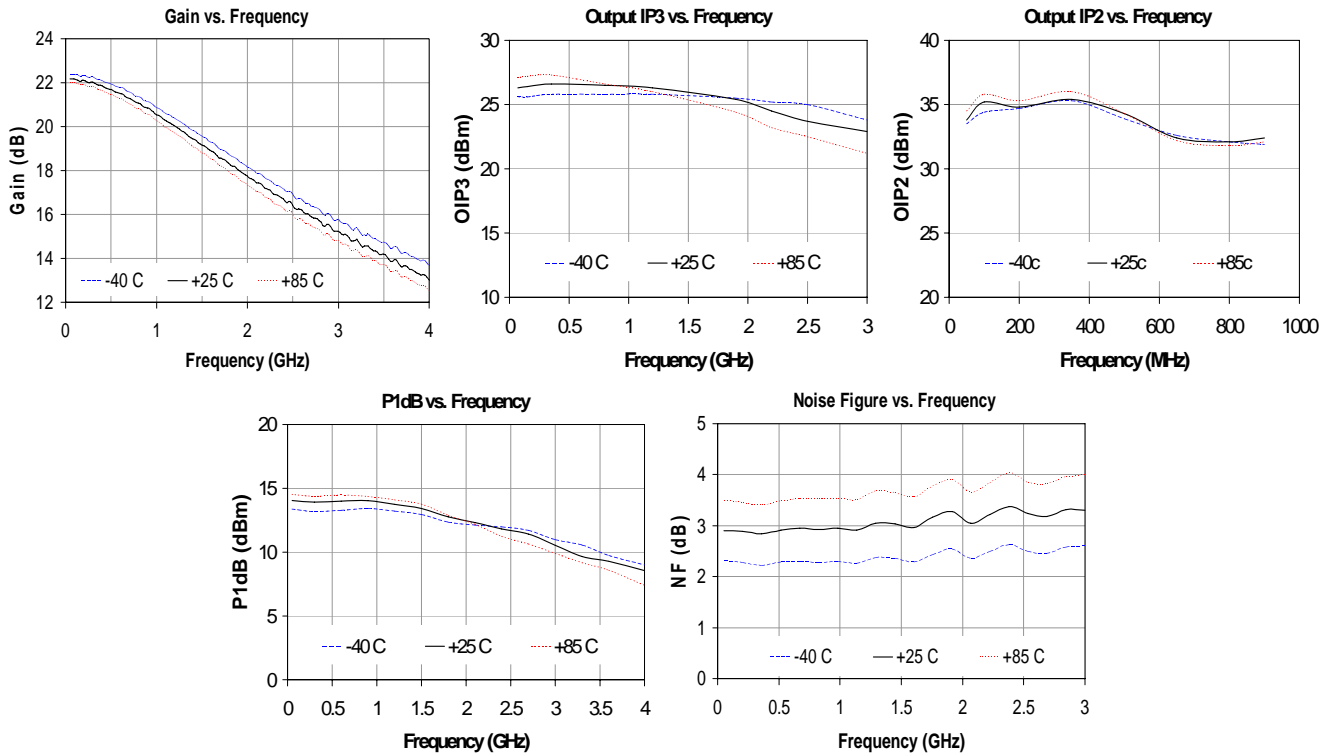

### Typical Device RF Performance

Supply Bias = +8 V,  $R_{bias} = 108 \Omega$ ,  $I_{cc} = 35 \text{ mA}$

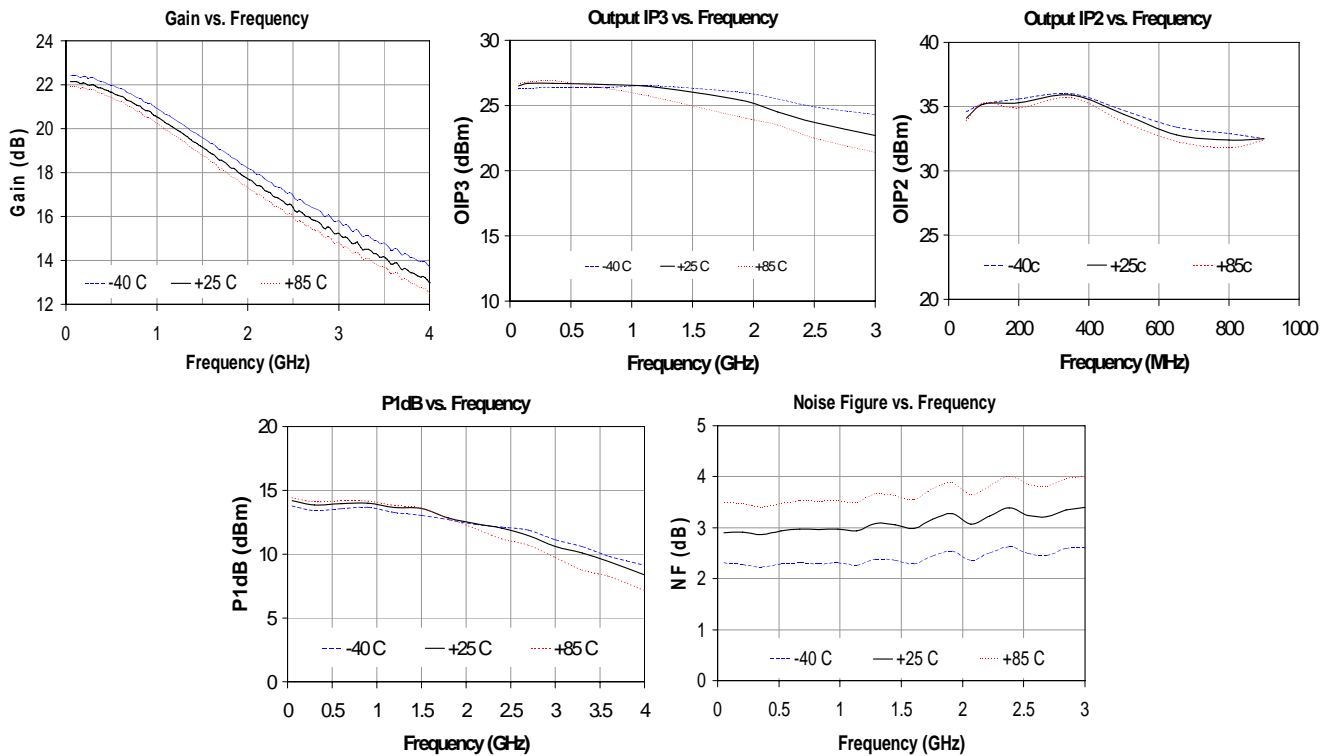

### Application Circuit

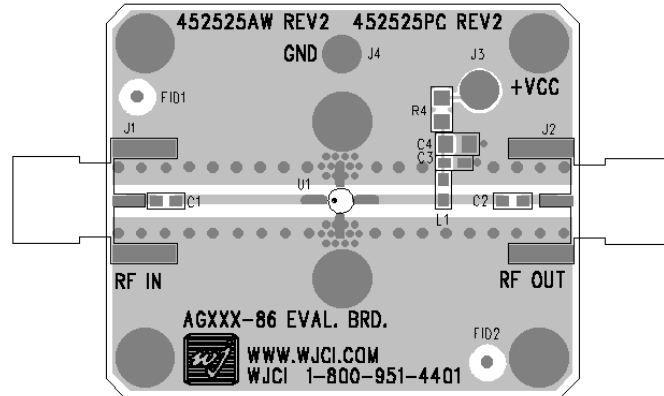
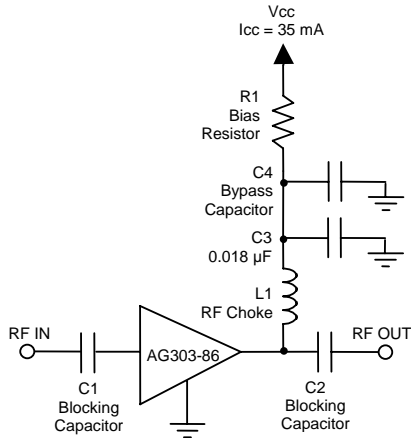

#### Recommended Component Values

| Reference Designator | Frequency (MHz) |         |        |       |       |       |       |
|----------------------|-----------------|---------|--------|-------|-------|-------|-------|
|                      | 50              | 500     | 900    | 1900  | 2200  | 2500  | 3500  |
| L1                   | 820 nH          | 220 nH  | 68 nH  | 27 nH | 22 nH | 18 nH | 15 nH |
| C1, C2, C4           | .018 µF         | 1000 pF | 100 pF | 68 pF | 68 pF | 56 pF | 39 pF |

- The proper values for the components are dependent upon the intended frequency of operation.
- The following values are contained on the evaluation board to achieve optimal broadband performance:

| Ref. Desig. | Value / Type             | Size |
|-------------|--------------------------|------|
| L1          | 39 nH wirewound inductor | 0603 |
| C1, C2      | 56 pF chip capacitor     | 0603 |
| C3          | 0.018 µF chip capacitor  | 0603 |
| C4          | Do Not Place             |      |
| R1          | 22.1 Ω 1% tolerance      | 0603 |

#### Recommended Bias Resistor Values

| Supply Voltage | R1 value  | Size |
|----------------|-----------|------|
| 5 V            | 22.1 ohms | 0603 |
| 6 V            | 51 ohms   | 0805 |
| 7 V            | 80 ohms   | 1206 |
| 8 V            | 108 ohms  | 1210 |
| 9 V            | 137 ohms  | 1210 |
| 10 V           | 166 ohms  | 1210 |
| 12 V           | 223 ohms  | 2010 |

The proper value for R1 is dependent upon the supply voltage and allows for bias stability over temperature. WJ recommends a minimum supply bias of +5 V. A 1% tolerance resistor is recommended.

### Typical Device Data

S-Parameters ( $V_{device} = +4.23$  V,  $I_{CC} = 35$  mA,  $T = 25$  °C, calibrated to device leads)

| Freq (MHz) | S11 (dB) | S11 (ang) | S21 (dB) | S21 (ang) | S12 (dB) | S12 (ang) | S22 (dB) | S22 (ang) |
|------------|----------|-----------|----------|-----------|----------|-----------|----------|-----------|
| 50         | -25.41   | -178.61   | 21.90    | 177.08    | -24.39   | 2.68      | -19.43   | -6.66     |
| 250        | -24.87   | 155.73    | 21.78    | 166.27    | -24.78   | 2.50      | -19.45   | -23.90    |
| 500        | -21.45   | 140.47    | 21.52    | 152.92    | -24.79   | 0.95      | -22.15   | -58.28    |
| 750        | -21.60   | 121.87    | 21.11    | 140.36    | -24.66   | -0.65     | -20.82   | -83.69    |
| 1000       | -22.37   | 104.08    | 20.62    | 128.55    | -24.69   | -0.47     | -19.91   | -103.53   |
| 1250       | -22.85   | 90.28     | 20.09    | 117.05    | -24.39   | 0.10      | -18.42   | -120.77   |
| 1500       | -23.73   | 71.50     | 19.48    | 106.85    | -23.69   | 0.62      | -17.78   | -130.98   |
| 1750       | -25.75   | 49.04     | 18.90    | 96.96     | -23.87   | -1.60     | -16.51   | -140.18   |
| 2000       | -25.80   | 20.48     | 18.25    | 87.61     | -23.36   | -1.98     | -16.04   | -146.19   |
| 2250       | -20.60   | 4.51      | 17.68    | 79.42     | -23.35   | -1.35     | -14.44   | -135.98   |
| 2500       | -21.35   | -10.34    | 17.27    | 73.31     | -23.42   | -5.50     | -14.66   | -143.15   |
| 2750       | -21.07   | -27.85    | 16.73    | 64.91     | -22.38   | -6.48     | -14.71   | -151.02   |
| 3000       | -20.28   | -38.57    | 16.22    | 57.01     | -22.30   | -5.72     | -15.40   | -161.21   |
| 3250       | -20.61   | -43.39    | 15.75    | 49.56     | -22.06   | -7.56     | -16.08   | -172.88   |
| 3500       | -21.43   | -46.83    | 15.30    | 42.14     | -21.79   | -9.98     | -16.63   | 172.37    |
| 3750       | -23.21   | -45.68    | 14.83    | 34.70     | -21.14   | -14.32    | -16.45   | 152.74    |
| 4000       | -25.23   | -33.68    | 14.43    | 27.45     | -21.01   | -19.42    | -15.95   | 135.04    |
| 4250       | -27.97   | -14.82    | 14.02    | 20.33     | -20.54   | -19.39    | -14.63   | 121.85    |
| 4500       | -28.62   | 21.21     | 13.56    | 13.29     | -19.99   | -23.59    | -13.70   | 110.85    |
| 4750       | -28.24   | 50.04     | 13.16    | 5.94      | -19.74   | -27.50    | -12.98   | 104.47    |
| 5000       | -27.40   | 61.17     | 12.84    | -0.90     | -19.45   | -32.13    | -12.53   | 101.02    |
| 5250       | -32.61   | 78.84     | 12.46    | -7.21     | -19.53   | -34.94    | -12.98   | 97.98     |
| 5500       | -38.22   | 144.81    | 12.12    | -13.47    | -19.19   | -37.72    | -13.34   | 99.21     |
| 5750       | -28.58   | -149.36   | 11.86    | -19.80    | -18.83   | -41.09    | -14.62   | 100.79    |
| 6000       | -24.71   | -137.35   | 11.61    | -26.11    | -18.61   | -44.88    | -15.38   | 100.73    |

Device S-parameters are available for download from the website at: <http://www.TriQuint.com>

### AG303-86G (Lead-free Sot-86 Package) Mechanical Information

This package is lead-free/RoHS-compliant. It is compatible with both lead-free (maximum 260 °C reflow temperature) and leaded (maximum 245 °C reflow temperature) soldering processes. The plating material on the pins is annealed matte tin over copper.

#### Outline Drawing

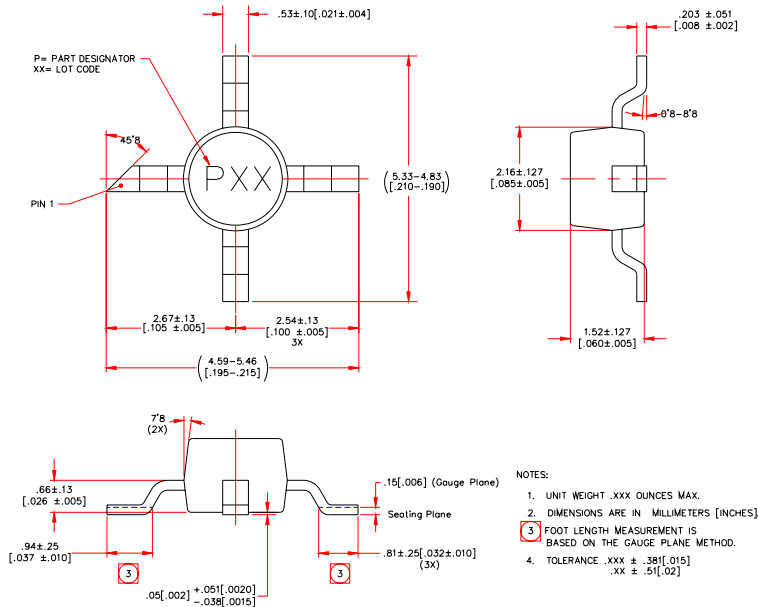

#### Land Pattern

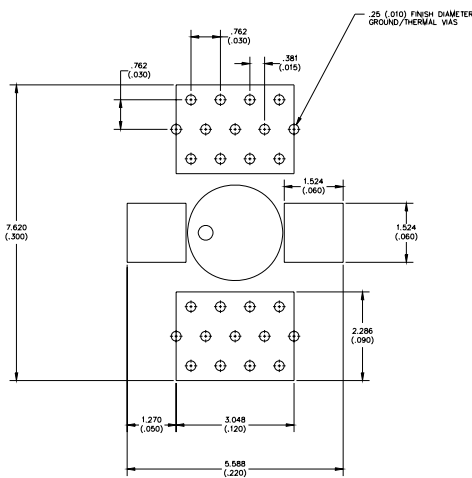

#### Product Marking

The component will be marked with a “P” designator followed by a two-digit numeric lot code on the top surface of the package. The obsolete tin-lead package is marked with an “E” designator followed by a two-digit numeric lot code.

Tape and reel specifications for this part are located on the website in the “Application Notes” section.

#### MSL / ESD Rating



**Caution!** ESD sensitive device.

ESD Rating: Class 1C  
 Value: Passes ≥ 1000V min.  
 Test: Human Body Model (HBM)  
 Standard: JEDEC Standard JESD22-A114

ESD Rating: Class IV  
 Value: Passes ≥ 1000V min.  
 Test: Charged Device Model (CDM)  
 Standard: JEDEC Standard JESD22-C101

MSL Rating: Level 3 at +260 °C convection reflow  
 Standard: JEDEC Standard J-STD-020

#### Mounting Config. Notes

1. Ground / thermal vias are critical for the proper performance of this device. Vias should use a .35mm (#80 / .0135”) diameter drill and have a final plated thru diameter of .25 mm (.010”).
2. Add as much copper as possible to inner and outer layers near the part to ensure optimal thermal performance.
3. Mounting screws can be added near the part to fasten the board to a heatsink. Ensure that the ground / thermal via region contacts the heatsink.
4. Do not put solder mask on the backside of the PC board in the region where the board contacts the heatsink.
5. RF trace width depends upon the PC board material and construction.
6. Use 1 oz. Copper minimum.
7. All dimensions are in millimeters (inches). Angles are in degrees.