



AG303

InGaP HBT Gain Block

The Communications Edge™

Preliminary Product Information

Product Features

- DC - 5000MHz
- +13 dBm P1dB at 900MHz
- +27 dBm OIP3 at 900MHz
- 20.5 dB Gain at 900MHz
- Single Voltage Supply
- SOT-363 or SOT-86 SMT Package
- Internally matched to 50 Ω

Product Description

The AG303 is a general-purpose buffer amplifier that offers high dynamic range in a low-cost surface-mount package. At 900 MHz, the AG303 typically provides 20.5 dB of gain, +27 dBm Output IP3, and +13 dBm P1dB. The device combines dependable performance with consistent quality to maintain MTBF values exceeding 100 years at mounting temperatures of +85°C and is housed in a SOT-363 & SOT-86 industry standard SMT packages.

The AG303 consists of Darlington pair amplifiers using the high reliability InGaP/GaAs HBT technology process technology and only requires DC-blocking capacitors, a bias resistor, and an inductive RF choke for operation.

The broadband MMIC amplifier can be directly applied to various current and next generation wireless technologies such as GPRS, GSM, CDMA, W-CDMA, and UMTS. In addition, the AG303 will work for other various applications within the DC to 5 GHz frequency range such as CATV and fixed wireless.

Functional Diagram

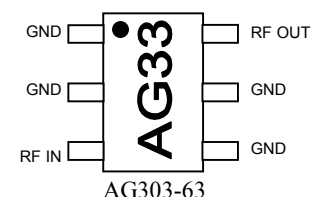
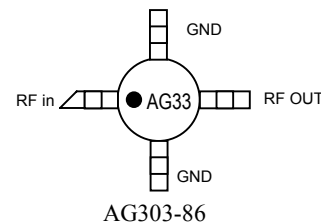

Specifications

Parameters ¹	Units	Min	Typ	Max
Frequency Range	MHz		DC-5000	
S21 - Gain	dB		20.5	
S11 - Input Return Loss	dB		-15	
S22 - Output Return Loss	dB		-15	
Output P1dB	dBm		+13	
Output IP3	dBm		+27	
Noise Figure	dB		3.6	
Device Voltage	V		4.0	
Device Current	mA		35	

Test conditions unless otherwise noted

1. T = 25°C, Supply Voltage = +5 V, R_{bias} = 30 Ω, Frequency = 900MHz, 50 Ω System.

2. 3OIP measured with two tones at an output power of -5 dBm/tone separated by 10MHz. The suppression on the largest IM3 product is used to calculate the 3OIP using a 2:1 rule.

Typical Parameters

Parameter ¹	Units	Typical	
Frequency	MHz	900	1900
S21	dB	20.5	19
S11	dB	-20	-15
S22	dB	-20	-20
Output P1dB	dBm	+13	+12
Output IP3	dBm	+27	+25
Noise Figure	dB	3.6	3.6
Supply Voltage	V	5	5
Device Current	mA	35	35

1. Data represents typical performance in an application board with T = 25°C, V_s = +5 V, and R_{bias} = 30 Ω in a 50 Ω system.

Absolute Maximum Ratings

Parameters	Rating
Operating Case Temperature	-40 to +85 °C
Storage Temperature	-40 to +125 °C

Operation of this device above any of these parameters may cause permanent damage

Application Circuit

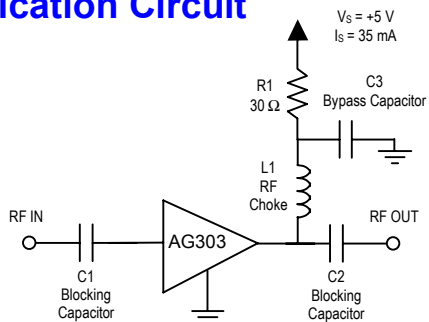

Ordering Information

Part No.	Description
AG303-63	InGaP HBT Gain Block SOT-363 Style Package (Available in Tape & Reel)
AG303-86	InGaP HBT Gain Block SOT-86 Style Package (Available in Tape & Reel)
AG303-63PCB	Fully Assembled Application Board
AG303-86PCB	Fully Assembled Application Board

This document contains information on a new product. Specifications and information are subject to change without notice



AG303

InGaP HBT Gain Block

Preliminary Product Information

AG303-86 Package Information

Outline Drawing

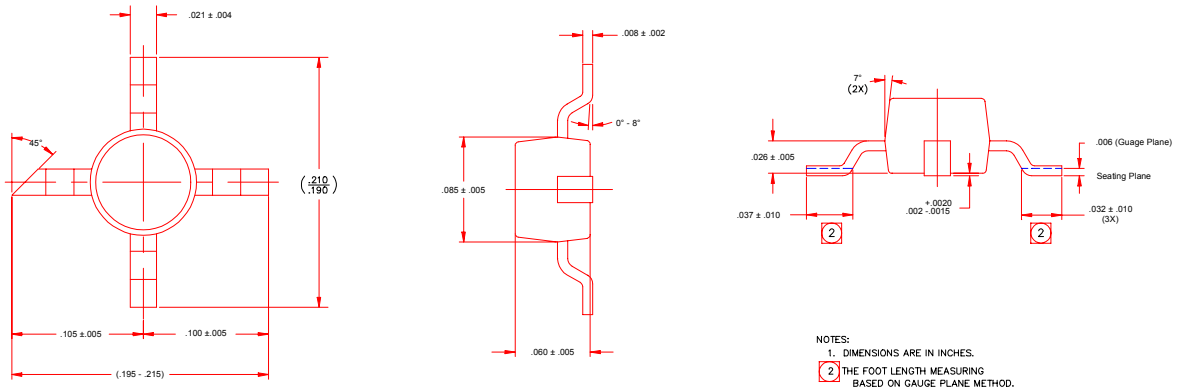

Land Pattern

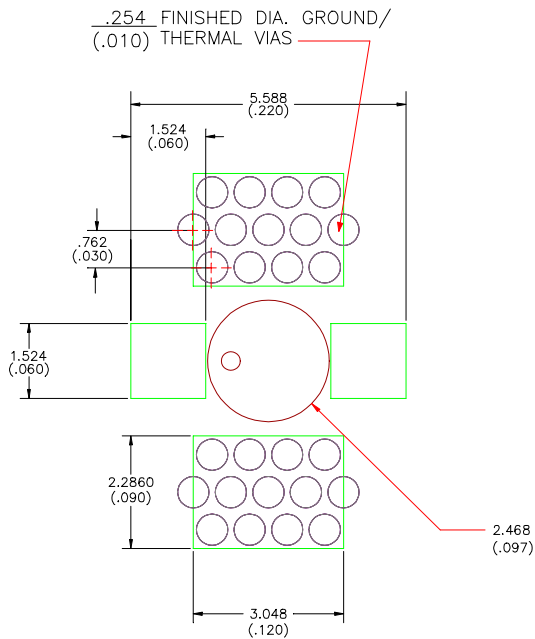

Mounting Configuration Notes

NOTES:

1. THERMAL/GROUND VIAS ARE CRITICAL FOR THE PROPER PERFORMANCE OF THIS PART. VIAS SHOULD USE A $.013$ " DIAMETER DRILL AND HAVE A FINAL, PLATED THRU DIAMETER OF $.010$ ".
2. ADD AS MUCH COPPER AS POSSIBLE TO INNER AND OUTER LAYERS NEAR THE PART TO ENSURE OPTIMAL THERMAL PERFORMANCE.
3. MOUNTING SCREWS ARE RECOMMENDED NEAR THE PART TO FASTEN THE BOARD TO A HEATSINK. ENSURE THAT THE THERMAL/GROUND VIAS CONTACT THE HEATSINK.
4. DO NOT PUT SOLDER MASK ON THE BACK SIDE OF THE PC BOARD IN THE REGIONS WHERE THE BOARD CONTACTS THE HEATSINK.
5. RF TRACE WIDTH DEPENDS UPON THE PC BOARD MATERIAL AND CONSTRUCTION.
6. USE 1 OZ. COPPER MINIMUM.
7. DIMENSIONS ARE IN MILLIMETERS / (INCHES).

This document contains information on a new product. Specifications and information are subject to change without notice.



AG303

InGaP HBT Gain Block

The Communications Edge™

Preliminary Product Information

AG303-63 Package Information

Outline Drawing

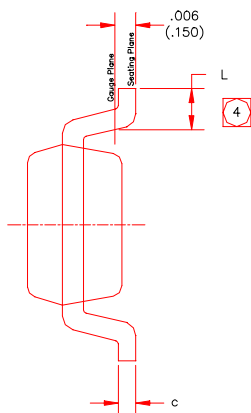
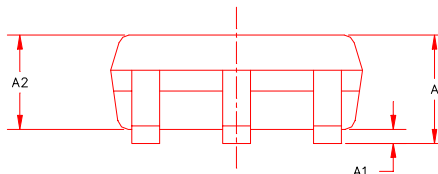
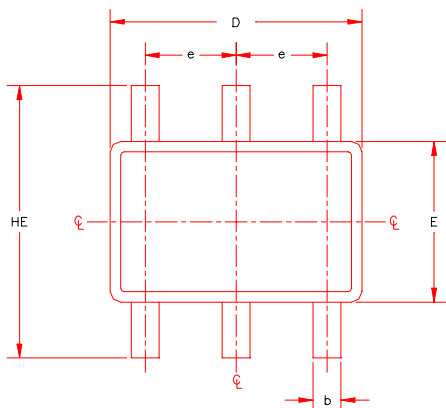

SYMBOL	MIN	MAX
E	.045 (1.15)	.053 (1.35)
D	.073 (1.85)	.089 (2.25)
HE	.079 (2.0)	.090 (2.30)
A	.031 (.80)	.043 (1.10)
A2	.031 (.80)	.039 (1.0)
A1	.000 (.00)	.004 (.10)
e	.026 (.65)	BSC BSC
b	.006 (.15)	.012 (.30)
c	.003 (.08)	.010 (.25)
L	.008 (.21)	.016 (.41)

NOTES:

- ALL DIMENSIONS ARE IN INCHES.
(MM)
- DIMENSIONS ARE EXCLUSIVE OF MOLD FLASH AND GATE BURR.
- ALL SPECIFICATIONS COMPLY TO JEDEC SPEC MO-203 ISSUE A.
- THE FOOT LENGTH MEASURING BASED ON GAUGE PLANE METHOD.

Land Pattern

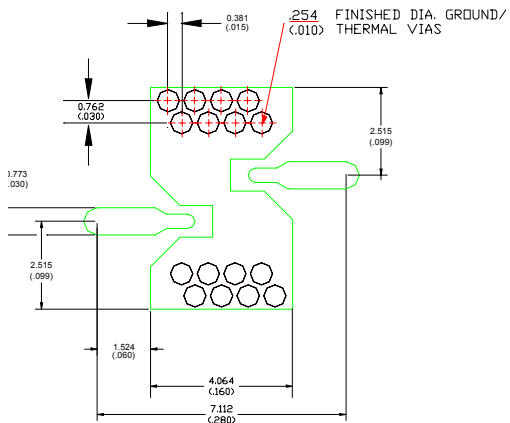

Mounting Configuration Notes

NOTES:

- THERMAL/GROUND VIAS ARE CRITICAL FOR THE PROPER PERFORMANCE OF THIS PART. VIAS SHOULD USE A .013" DIAMETER DRILL AND HAVE A FINAL, PLATED THRU DIAMETER OF .010".
- ADD AS MUCH COPPER AS POSSIBLE TO INNER AND OUTER LAYERS NEAR THE PART TO ENSURE OPTIMAL THERMAL PERFORMANCE.
- ADD MOUNTING SCREWS NEAR THE PART TO FASTEN THE BOARD TO A HEATSINK. ENSURE THAT THE THERMAL/GROUND VIAS CONTACT THE HEATSINK.
- DO NOT PUT SOLDER MASK ON THE BACK SIDE OF THE PC BOARD IN THE REGIONS WHERE THE BOARD CONTACTS THE HEATSINK.
- RF TRACE WIDTH DEPENDS UPON THE PC BOARD MATERIAL AND CONSTRUCTION.
- USE 1 OZ. COPPER MINIMUM.
- DIMENSIONS ARE IN MILLIMETERS (INCHES).

This document contains information on a new product. Specifications and information are subject to change without notice