

AZ DISPLAYS, INC.

COMPLETE LCD SOLUTIONS

SPECIFICATIONS FOR LIQUID CRYSTAL DISPLAY

www.DataSheet4U.com

PART NUMBER:

AGM1216B Series

REVISED:

MAY 14, 2003

General Specifications

Item	<input checked="" type="checkbox"/> Standard Value	Unit
Display Pattern	<input checked="" type="checkbox"/> Graphic <input type="checkbox"/> Character <input type="checkbox"/> Segment <input type="checkbox"/> _____ <input type="checkbox"/> with ICON	
Color	<input type="checkbox"/> Mono. <input type="checkbox"/> Grayscale <input checked="" type="checkbox"/> _65K_____	
Module Dimension (W x H x T)	33.54 (W) x 44.9 (H) x 1.46 (T)	mm
Viewing Area (W x H)	30.54(W)X36.04(H)	mm
Active Area (W x H)	28.02(W)X35.028(H)	mm
Character Size (W x H)	\	mm
Character Pitch (W x H)	\	mm
DOT Size (W x H)	0.061(W)X0.207(H)	mm
DOT Pitch (W x H)	0.073(W)X0.219(H)	mm
LCD Type	<input type="checkbox"/> TN, Positive <input type="checkbox"/> TN, Negative <input type="checkbox"/> HTN, Positive <input type="checkbox"/> HTN, Negative	
	<input type="checkbox"/> STN, Yellow-Green <input type="checkbox"/> STN, Gray <input type="checkbox"/> STN, Blue <input type="checkbox"/> FSTN, Positive <input type="checkbox"/> FSTN, Negative	
	<input type="checkbox"/> _____ <input type="checkbox"/> FM LCD <input checked="" type="checkbox"/> Color STN	
Polarizer Type	<input type="checkbox"/> Transflective <input checked="" type="checkbox"/> Transmissive <input type="checkbox"/> Reflective <input type="checkbox"/> Anti-Glare	
View Direction	<input checked="" type="checkbox"/> 6H <input type="checkbox"/> 12H <input type="checkbox"/> _____	
LCD Controller & Driver	S6B33B2 (or Equivalent)	
LCD Driving Method	1/162duty, 1/5bias	
Interface Type	Serial <input type="checkbox"/> I ² C <input type="checkbox"/> 4-line SPI <input type="checkbox"/> 3-line SPI <input type="checkbox"/> _____	
	Parallel <input checked="" type="checkbox"/> 6800 <input checked="" type="checkbox"/> 8080 <input type="checkbox"/> 4-bit <input type="checkbox"/> _____	
Backlight Type	<input checked="" type="checkbox"/> LED <input type="checkbox"/> Bottom <input checked="" type="checkbox"/> Single Side <input type="checkbox"/> Dual Side	
	<input type="checkbox"/> _____ <input type="checkbox"/> EL <input type="checkbox"/> CCFL	
Backlight Color	<input type="checkbox"/> Yellow-Green <input checked="" type="checkbox"/> White <input type="checkbox"/> Amber <input type="checkbox"/> Blue <input type="checkbox"/> Red <input type="checkbox"/> _____	
EL/CCFL Driver type	<input type="checkbox"/> Build-in <input type="checkbox"/> External	
DC-DC Converter	<input checked="" type="checkbox"/> Build-in <input type="checkbox"/> External	
Operation Temperature	T _{OPL} = -0 T _{OPH} = 50	°C
Storage Temperature	T _{STL} = -10 T _{STH} = 60	°C

Note:

T_{OPL}: Lowest Operation Temperature.

T_{OPH}: Highest Operation Temperature.

T_{STL}: Lowest Storage Temperature.

T_{STH}: Highest Storage Temperature.

Electro-optical Specifications

1 Absolute Maximum Ratings

No	Item	Symbol	Min.	Max.	Unit
1	Supply Voltage For Logic	$V_{DD} - V_{SS}$	-0.3	4.0	V
2	Supply Voltage For LCD Driver	V_{LCD}	-0.3	22.0	V
3	Input Voltage	V_I	$V_{SS} - 0.3$	$V_{DD} + 0.3$	V

Note: Operating Temperature and Storage Temperature can be found in 1. General Specifications.

2 Optical Characteristics

$T_a = 25^\circ\text{C}$

ITEM	SYMBOL	CONDITION	MIN	TYP	MAX	UNIT	DRIVE	
LCD driving voltage	V_{op}		0	(9.3)	(9.8)	(10.3)	V	
			25	(9.0)	(9.5)	(10.0)		
			50	(8.6)	(9.1)	(9.6)		
Response time	Rise	T_r	$= 0^\circ$	0	-	(530)	ms	
				25	-	(200)		(250)
	Down	T_d	$= 0^\circ$	0	-	(200)		(250)
				25	-	(85)		
Contrast ratio	CR	$= 0^\circ$	(20)	(25)	-	%	A *1	
Transmittance	T	-	(3.6)	(6.0)	-	%		
Viewing angle range	$6H$ $= 270^\circ$	CR 2	1	50		deg.		
	$12H$ $= 90^\circ$		2	25				
	$3H$ $= 0^\circ$		3	45				
	$9H$ $= 180^\circ$		4	60				
Chromaticity Coordinates *2	White	X	$= 0^\circ$	(0.20)	(0.25)	(0.30)	-	B*1
		Y		(0.25)	(0.30)	(0.35)		
	Red	X	$= 0^\circ$	(0.34)	(0.39)	(0.44)		
		Y		(0.26)	(0.31)	(0.36)		
	Green	X	$= 0^\circ$	(0.24)	(0.29)	(0.34)		
		Y		(0.46)	(0.51)	(0.56)		
Blue	X	$= 0^\circ$	(0.15)	(0.18)	(0.21)			
	Y		(0.12)	(0.15)	(0.18)			
Color gamut (NTSC)	S		-	(18)	-	%		

Note:

*1 Driving A - Duty driving by DMS505 (fFRM = 100Hz, 1/132 duty, 1/6 bias)

Driving B - Duty driving by Actual driver IC

*2 Backlight coordinates (x , y) = (0.31 , 0.32)

4.3 Electrical Characteristics

No	Item	Symbol	Condition	Min.	Typ.	Max.	Unit
1	Supply Voltage for Logic	$V_{DD}-V_{SS}$	-	2.8	3.0	3.3	V
2	Supply Voltage for LCD Driver	V_{LCD}	$T_a=23\pm 3^{\circ}C$		9.4		V
3	Supply Current for Logic	I_{DD}	-....			3.0	mA
5	Input High Voltage	V_{IH}	-	0.8xVDD	-	VDD	V
6	Input Low Voltage	V_{IL}	-	VSS	-	0.2xVDD	V
7	Output High Voltage	V_{OH}	$I_{OH}=0.5mA$	0.8xVDD	-	VDD	V
8	Output Low Voltage	V_{OL}	$I_{OL}=0.5mA$	VSS	-	0.2xVDD	V
9	Supply Current for LED Backlight	I_{LED}	$V_{LED} = Typ.$ $T_a=23\pm 3^{\circ}C$	-	15	-	mA
10	Supply Voltage for LED Backlight	V_{LED}	$I_{LED} = Typ.$ $T_a=23\pm 3^{\circ}C$	-	9.6	10.0	V
11	Luminance	Lv	$I_{LED} = Typ.$ $T_a=23\pm 3^{\circ}C$	3000	3300	-	cd/m ²

Timing Characteristics

See Data sheet of LCD Driver for detail.

Programming

Instruction Table

See Data sheet of LCD Driver for detail.

Display Data RAM

Relationship between display pattern and Display Data RAM show as below:

XA Address	YA Address																
	00H	01H	02H	03H	04H	05H	06H	07H	08H	-----	7DH	7EH	7FH	80H	81H	82H	83H
00H										-----							
01H										-----							
02H										-----							
03H										-----							
04H										-----							
05H										-----							
06H										-----							
07H										-----							
08H										-----							
09H										-----							
0AH										-----							
0BH										-----							
0CH										-----							
0DH										-----							
0EH										-----							
0FH										-----							
⋮										⋮							
B2H										-----							
B3H										-----							
B4H										-----							
B5H										-----							
B6H										-----							
B7H										-----							
B8H										-----							
B9H										-----							
BAH										-----							
BBH										-----							
BCH										-----							
BDH										-----							
BEH										-----							
BFH										-----							
A0H										-----							
A1H										-----							

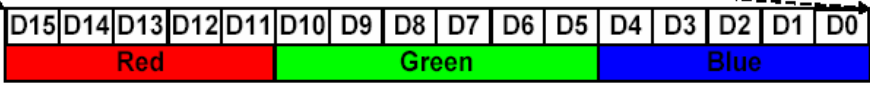

See Data sheet of LCD Driver for detail.

I/O Terminal

1 Pin Description(See Datasheet of LCD Driver for detail)

Pin NO.	Symbol	Function Description																												
1	OTPD	Drain Voltage for OTP programming.																												
2	OTPG	Gate Voltage for OTP programming.																												
3	PS																													
4~5	MPU1~MP U0	MPU interface select pin																												
		<table border="1"> <thead> <tr> <th>PS</th> <th>MPU[1]</th> <th>MPU[0]</th> <th>Description</th> </tr> </thead> <tbody> <tr> <td>H</td> <td>L</td> <td>L</td> <td>8080-series 8bit interface</td> </tr> <tr> <td>H</td> <td>L</td> <td>H</td> <td>8080-series 16bit interface</td> </tr> <tr> <td>H</td> <td>H</td> <td>L</td> <td>6800-series 8bit interface</td> </tr> <tr> <td>H</td> <td>H</td> <td>H</td> <td>6800-series 16bit interface</td> </tr> <tr> <td>L</td> <td>L</td> <td>X</td> <td>3 pin SPI(Write only)</td> </tr> <tr> <td>L</td> <td>H</td> <td>X</td> <td>4 pin SPI(Write only)</td> </tr> </tbody> </table>	PS	MPU[1]	MPU[0]	Description	H	L	L	8080-series 8bit interface	H	L	H	8080-series 16bit interface	H	H	L	6800-series 8bit interface	H	H	H	6800-series 16bit interface	L	L	X	3 pin SPI(Write only)	L	H	X	4 pin SPI(Write only)
		PS	MPU[1]	MPU[0]	Description																									
		H	L	L	8080-series 8bit interface																									
		H	L	H	8080-series 16bit interface																									
		H	H	L	6800-series 8bit interface																									
		H	H	H	6800-series 16bit interface																									
L	L	X	3 pin SPI(Write only)																											
L	H	X	4 pin SPI(Write only)																											
6	CSB	Chip select input pins Data / instruction I/O is enabled only when CSB is " L ". When chip select is non-active, DB0 to DB15 may be high impedance.																												
7	RESETB	Reset input pin. When RESETB is " L ", initialization is executed.																												
8	RS	Data / Instruction select input pin . RS = " H " : DB0 to DB15 are display data . RS = " L " : DB0 to DB7 are instruction data																												
9	WRB	Read / Write execution control pin																												
		<table border="1"> <thead> <tr> <th>PS</th> <th>MPU</th> <th>MPU Type</th> <th>WRB</th> <th>Description</th> </tr> </thead> <tbody> <tr> <td>H</td> <td>H</td> <td>6800-series</td> <td>R/W</td> <td>ReadWRBite control input pin - R/W = "H": read - R/W = "L": write</td> </tr> <tr> <td>H</td> <td>L</td> <td>8080-series</td> <td>WRB</td> <td>Write enable clock input pin The data on DB0 to DB15 are latched at the rising edge of the WRB signal.</td> </tr> </tbody> </table>	PS	MPU	MPU Type	WRB	Description	H	H	6800-series	R/W	ReadWRBite control input pin - R/W = "H": read - R/W = "L": write	H	L	8080-series	WRB	Write enable clock input pin The data on DB0 to DB15 are latched at the rising edge of the WRB signal.													
		PS	MPU	MPU Type	WRB	Description																								
H	H	6800-series	R/W	ReadWRBite control input pin - R/W = "H": read - R/W = "L": write																										
H	L	8080-series	WRB	Write enable clock input pin The data on DB0 to DB15 are latched at the rising edge of the WRB signal.																										
10	RDB	Read / Write execution control pin																												
10	RDB	<table border="1"> <thead> <tr> <th>MPU[1]</th> <th>MPU type</th> <th>RDB</th> <th>Description</th> </tr> </thead> <tbody> <tr> <td>H</td> <td>6800-series</td> <td>E</td> <td>Read / Write control input pin - R/W = "H": When E is "H", DB0 to DB15 are in an output status. - R/W = "L": The data on DB0 to DB15 are latched at the falling edge of the E signal.</td> </tr> <tr> <td>L</td> <td>8080-series</td> <td>RDB</td> <td>Read enable clock input pin When RDB is "L", DB0 to DB15 are in an output status.</td> </tr> </tbody> </table>	MPU[1]	MPU type	RDB	Description	H	6800-series	E	Read / Write control input pin - R/W = "H": When E is "H", DB0 to DB15 are in an output status. - R/W = "L": The data on DB0 to DB15 are latched at the falling edge of the E signal.	L	8080-series	RDB	Read enable clock input pin When RDB is "L", DB0 to DB15 are in an output status.																
		MPU[1]	MPU type	RDB	Description																									
		H	6800-series	E	Read / Write control input pin - R/W = "H": When E is "H", DB0 to DB15 are in an output status. - R/W = "L": The data on DB0 to DB15 are latched at the falling edge of the E signal.																									
L	8080-series	RDB	Read enable clock input pin When RDB is "L", DB0 to DB15 are in an output status.																											
11~26	DB0~DB15	DB[0:15]: 16-bit bi-directional data bus.																												
27	GND	GND																												
28	VDD	VDD																												
29	VRN	NC																												
30	VRP	NC																												
31	VIN	NC																												

32	VT	NC
33	NC	NC

Block Diagram

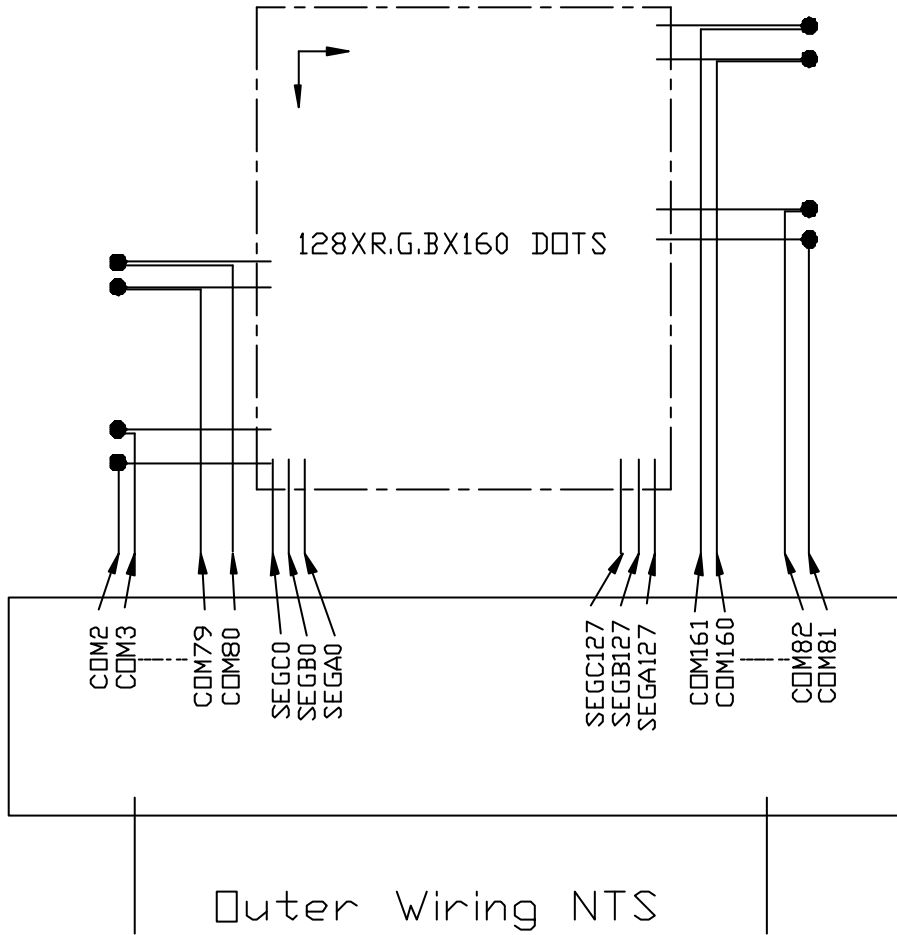

*View from surface of Terminal

Application Circuit

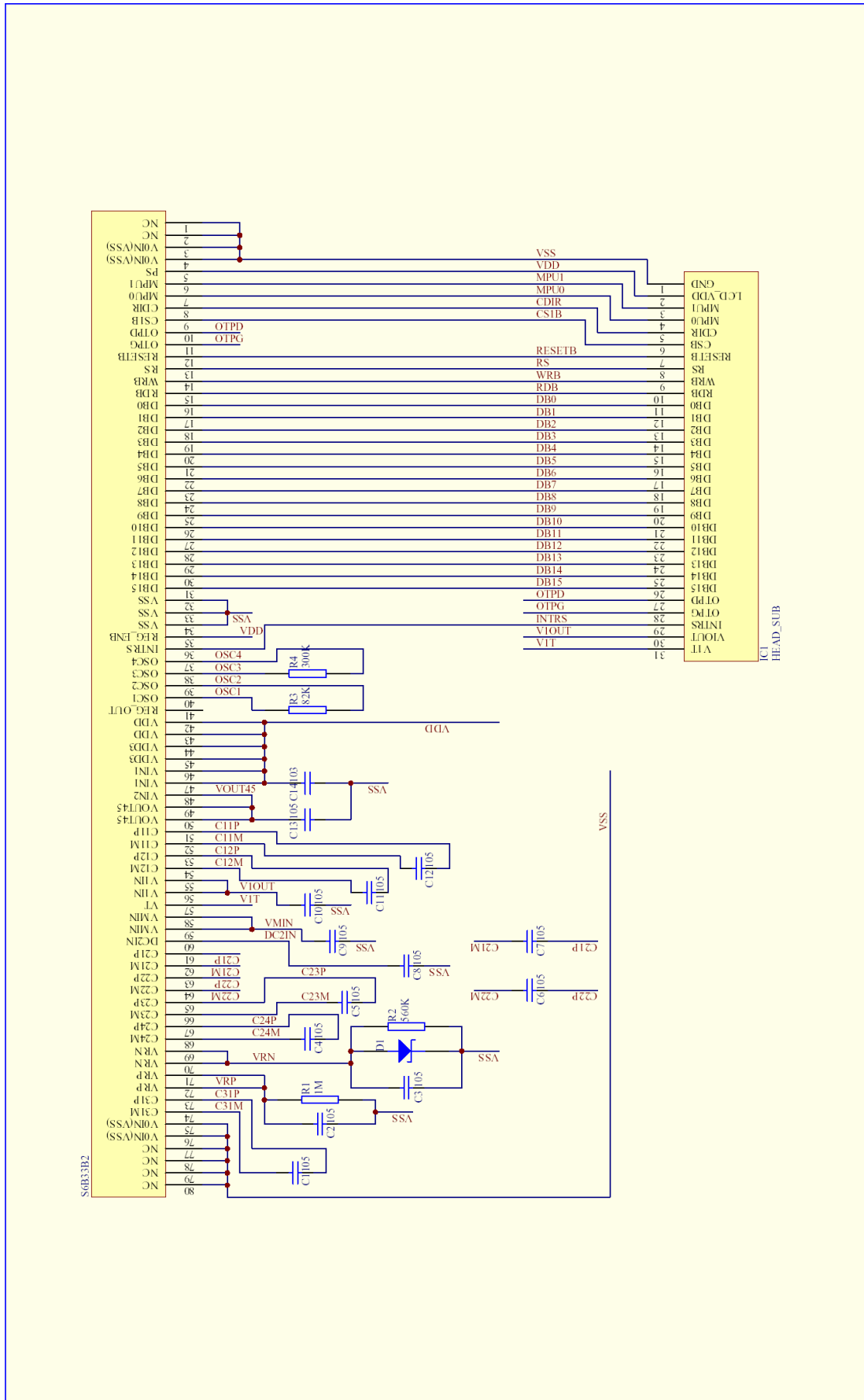

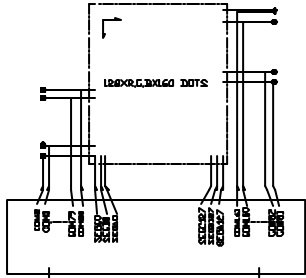

Outer Wiring NTS
*View from surface of Terminal

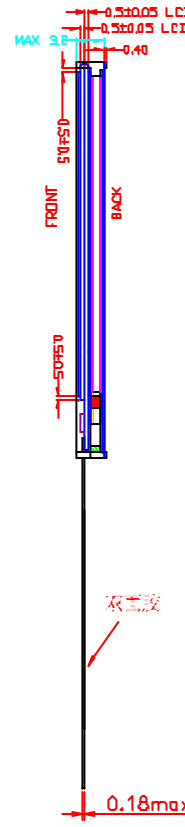
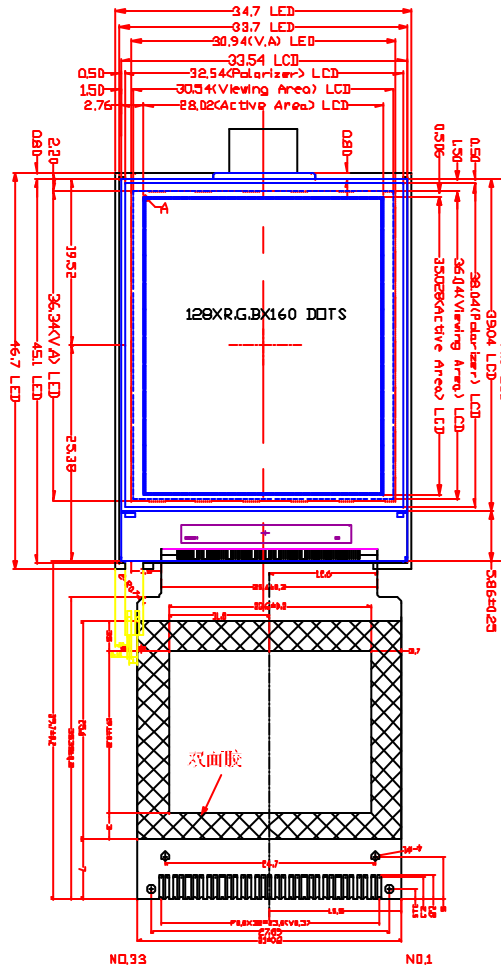

Display Type : CSTN / Transmissive
Viewing Direction : 60D
Driver IC : S6B33B2
Logic Voltage : 3.0±0.1V
LCD Driver Voltage (Vlcd) : 9.4
Driving Method : 1/16D DUTY 1/5 BIAS
Operating Temperature : -0° ~ +50°C
Storage Temperature : -10° ~ +60°C
Interface Connector : FPC
Led color : white
VLED=9.0V Iled(type)=15mA
Luminance : 3000cd/m²(type)
All unmarked tolerances ±0.2mm

33	NC	17	DB6
32	V17	16	DB5
31	V16	15	DB4
30	V15	14	DB3
29	V14	13	DB2
28	V13	12	DB1
27	V12	11	DB0
26	V11	10	R1B
25	V10	9	WRB
24	V9	8	RS
23	V8	7	RESETB
22	V7	6	CS1D
21	V6	5	MPIU
20	V5	4	MPLU
19	V4	3	PS
18	V3	2	OTPG
17	V2	1	OTPD
DBA	DBA	DBA	DBA

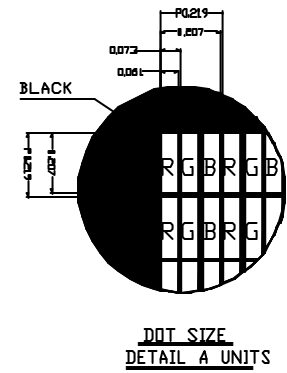

AZ Displays, Inc.

AGM1216B
DWG NO:ED-4772-LCM/A00

UNITS: mm
SHEET 1 OF 1

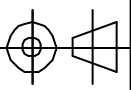

CUSTOMER APPROVAL:

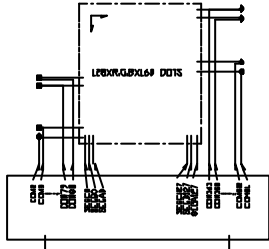

Display Type : CSTN / Transmissive
 Viewing Direction : 6:00
 Driver IC : S6B33B2
 Logic Voltage : 3.0±0.1V
 LCD Driver Voltage (Vcd) : 9.4
 Driving Method : 1/162 DUTY 1/3 BIAS
 Operating Temperature : -20~ +70°C
 Storage Temperature : -30~ +80°C
 Interface Connector : FPC
 All unmarked tolerances : ±0.2mm

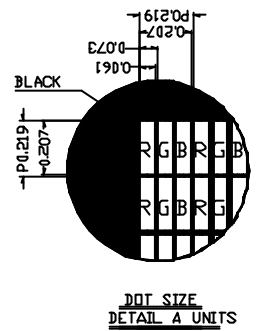
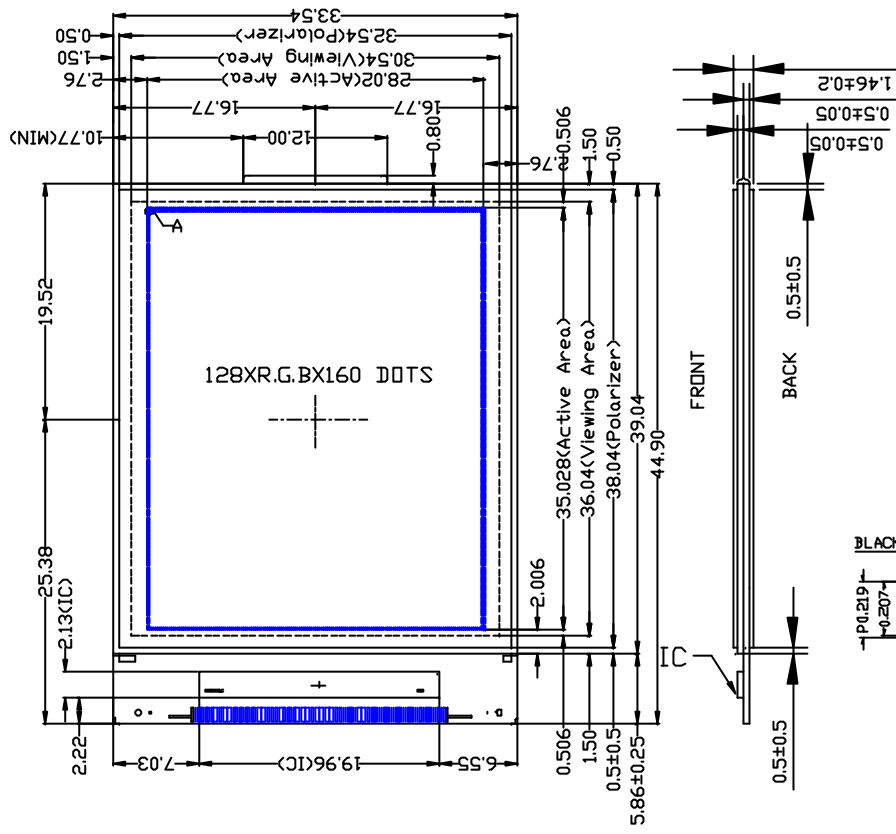

AZ Displays, Inc.

AGM1216B
 DWG NO:ED-4772-LCM/A00
 UNITS: mm
 SHEET 1 OF 3

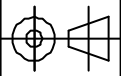

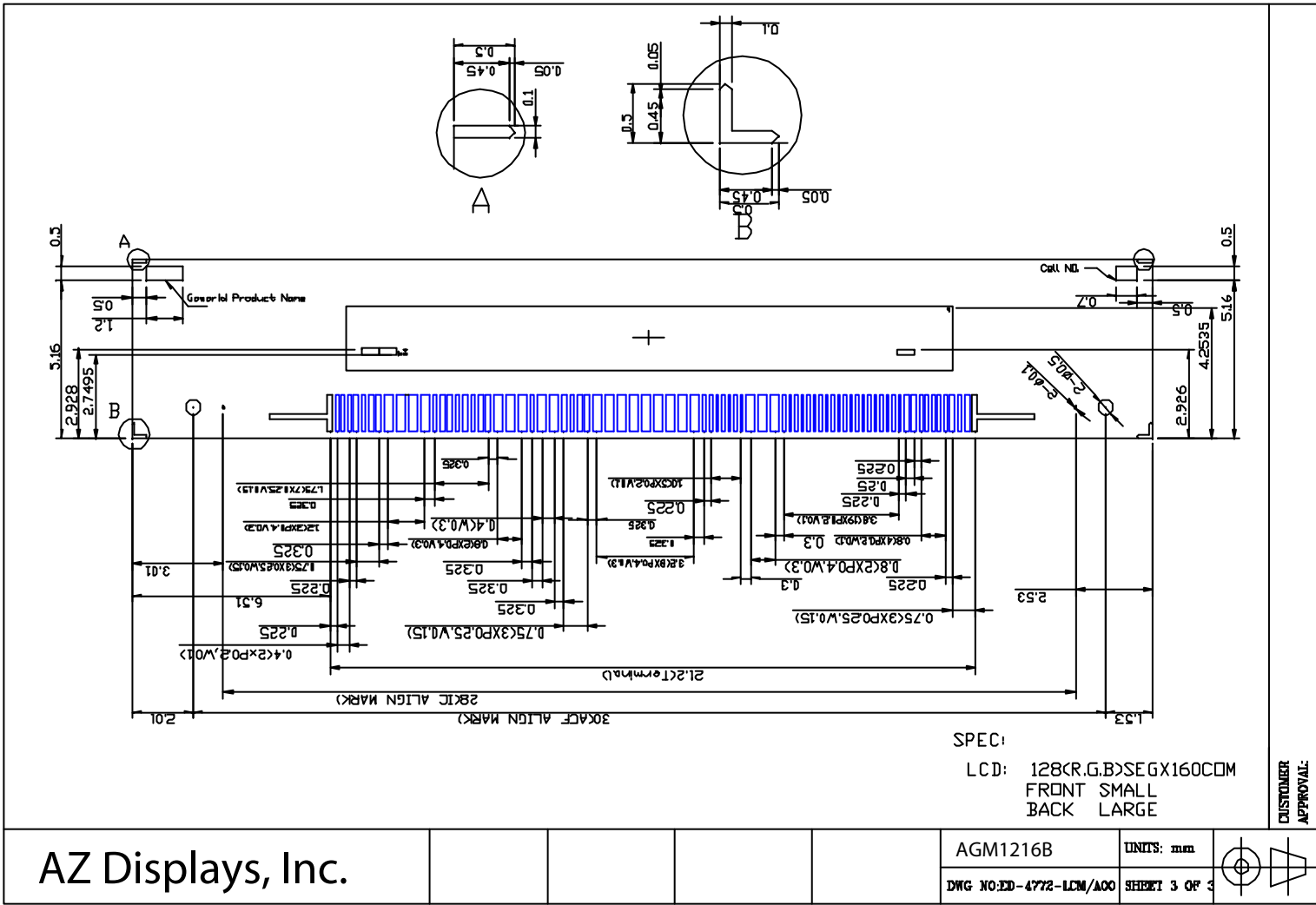

SPEC:

LCD: 128<R.G.B>SEGX160CDM

FRONT SMALL

BACK LARGE

CUSTOMER APPROVAL:

AZ Displays, Inc.

AGM1216B

UNITS: mm

DWG NO: ED-4772-LCM/A00

SHEET 3 OF 3

