

● General Description

The AGM12N65F combines advanced trench MOSFET technology with a low resistance package to provide extremely low $R_{DS(ON)}$.

This device is ideal for load switch and battery protection applications.

● Features

- Advance high cell density Trench technology
- Low $R_{DS(ON)}$ to minimize conductive loss
- Low Gate Charge for fast switching
- Low Thermal resistance

● Application

- Electronic Ballast
- Electronic Transformer
- Switch Mode Power Supply

Product Summary

BVDSS	RDSON	ID
650V	0.76Ω	12A

TO-220F Pin Configuration

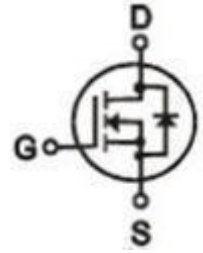

Package Marking and Ordering Information

Device Marking	Device	Device Package	Reel Size	Tape width	Quantity
AGM12N65F	AGM12N65F	TO-220F	----	----	1000

Table 1. Absolute Maximum Ratings (Tc=25°C)

Symbol	Parameter	Value	Unit
VDS	Drain-Source Voltage (VGS=0V)	650	V
VGS	Gate-Source Voltage (VDS=0V)	±30	V
ID	Drain Current-Continuous(Tc=25°C) (Note 1)	12	A
	Drain Current-Continuous(Tc=100°C)	4.8	A
IDM (pluse)	Drain Current-Continuous@ Current-Pulsed (Note 2)	48	A
PD	Maximum Power Dissipation(Tc=25°C)	65	w
	Maximum Power Dissipation(Tc=100°C)	26	w
EAS	Avalanche energy (Note 3)	352	mJ
TJ,TSTG	Operating Junction and Storage Temperature Range	-55 To 150	°C

Table 2. Thermal Characteristic

Symbol	Parameter	Typ	Max	Unit
RθJA	Thermal Resistance Junction-ambient (Steady State) ¹	---	62.5	°C/W
RθJC	Thermal Resistance Junction-Case ¹	---	1.92	°C/W

Table 3. Electrical Characteristics (TC=25°C unless otherwise noted)

Symbol	Parameter	Conditions	Min	Typ	Max	Unit
On/Off States						
BVDSS	Drain-Source Breakdown Voltage	VGS=0V ID=250μA	650	--	--	V
IDSS	Zero Gate Voltage Drain Current	VDS=650V, VGS=0V	--	--	1	μA
IGSS	Gate-Body Leakage Current	VGS=±30V, VDS=0V	--	--	±100	nA
VGS(th)	Gate Threshold Voltage	VDS=VGS, ID=250μA	3.0	--	4.0	V
gFS	Forward Transconductance	VDS=15V, ID=6.0A	--	--	--	S
RDS(on)	Drain-Source On-State Resistance	VGS=10V, ID=6.0A	--	0.76	0.84	Ω
		VGS=4.5V, ID=6.0A	--	--	--	Ω
Dynamic Characteristics						
Ciss	Input Capacitance	VDS=25V, VGS=0V, F=1MHZ	--	1641	--	pF
Coss	Output Capacitance		--	162	--	pF
Crss	Reverse Transfer Capacitance		--	20	--	pF
Rg	Gate resistance	VGS=0V, VDS=0V, f=1.0MHz	--	--	--	Ω
Switching Times						
td(on)	Turn-on Delay Time	VDD=325V, ID=12A, RGEN=25Ω	--	47	--	nS
tr	Turn-on Rise Time		--	32	--	nS
td(off)	Turn-Off Delay Time		--	219	--	nS
tf	Turn-Off Fall Time		--	58	--	nS
Qg	Total Gate Charge	VGS=10V, VDS=520V, ID=12A	--	51	--	nC
Qgs	Gate-Source Charge		--	7.1	--	nC
Qgd	Gate-Drain Charge		--	24.5	--	nC
Source-Drain Diode Characteristics						
ISD	Source-Drain Current(Body Diode)		--	--	12	A
VSD	Forward on Voltage	VGS=0V, ISD=6A	--	--	1.4	V
trr	Reverse Recovery Time	Vgs=0V, IF=12A ,	--	579	--	ns
Qrr	Reverse Recovery Charge	dI/dt=100A/μs , TJ=25°C	--	2.9	--	nc

Notes 1.The maximum current rating is package limited.

Notes 2.Repetitive Rating: Pulse width limited by maximum junction temperature

Notes 3.EAS condition: TJ=25°C

Typical Characteristics $T_J = 25^\circ\text{C}$, unless otherwise noted

Figure 1. Output Characteristics ($T_J = 25^\circ\text{C}$)

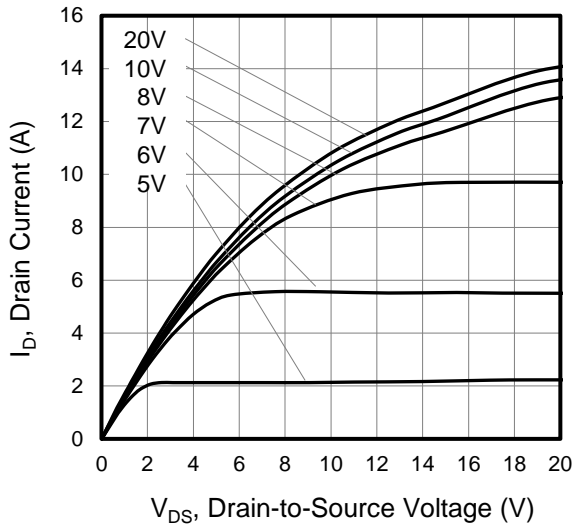

Figure 2. Body Diode Forward Voltage

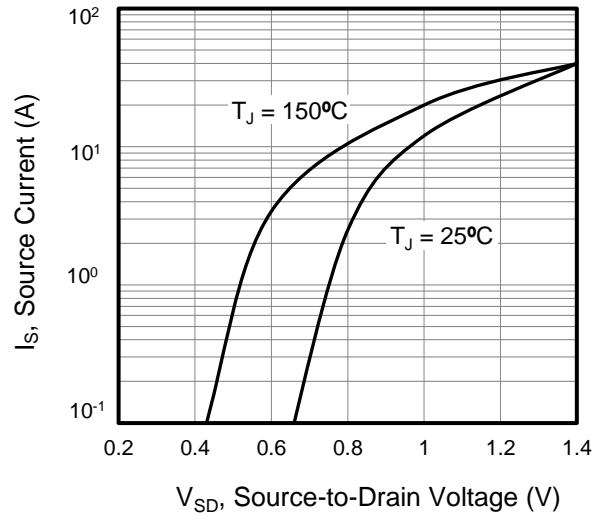

Figure 3. Drain Current vs. Temperature

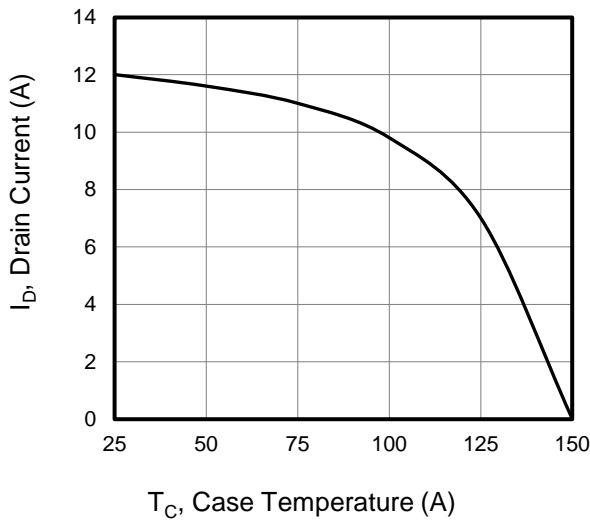

Figure 4. BV_{DSS} Variation vs. Temperature

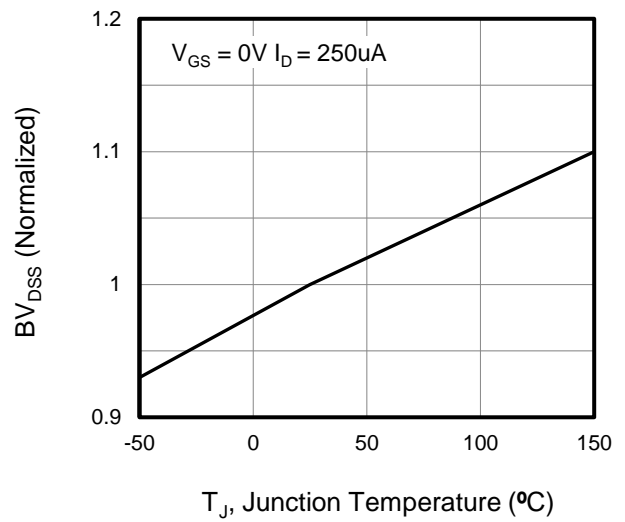

Figure 5. Transfer Characteristics

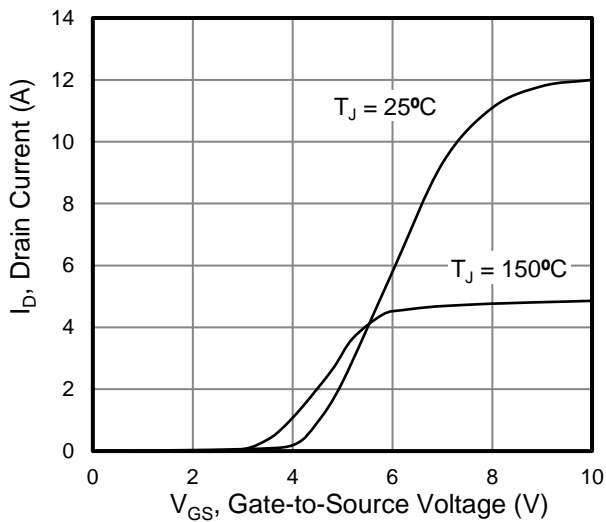
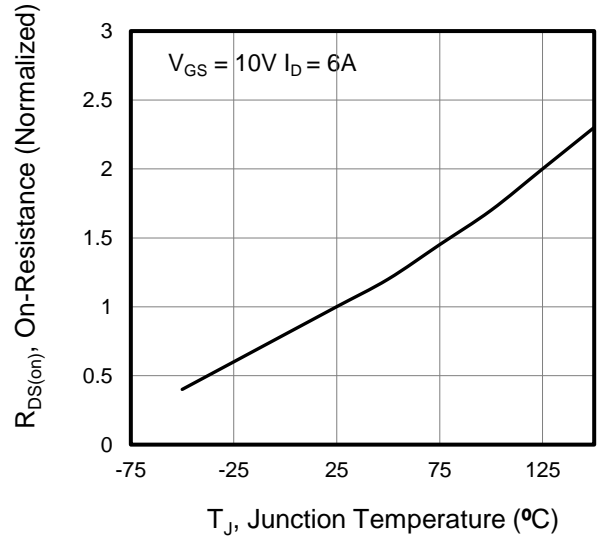

Figure 6. On-Resistance vs. Temperature



Typical Characteristics $T_J = 25^\circ\text{C}$, unless otherwise noted

Figure 7. Capacitance

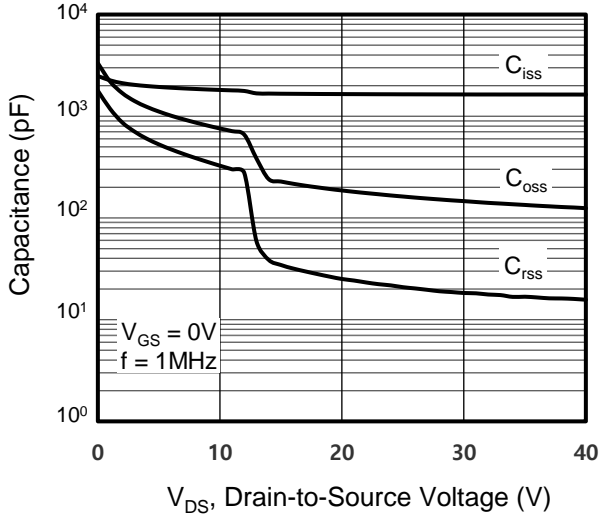

Figure 8. Gate Charge

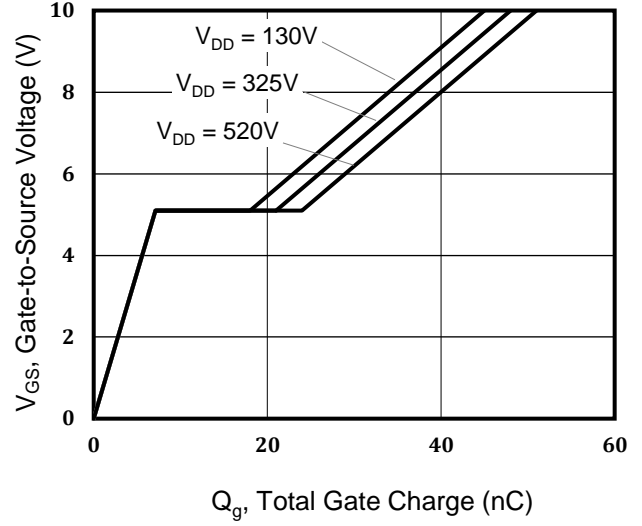

Figure 9. Transient Thermal Impedance

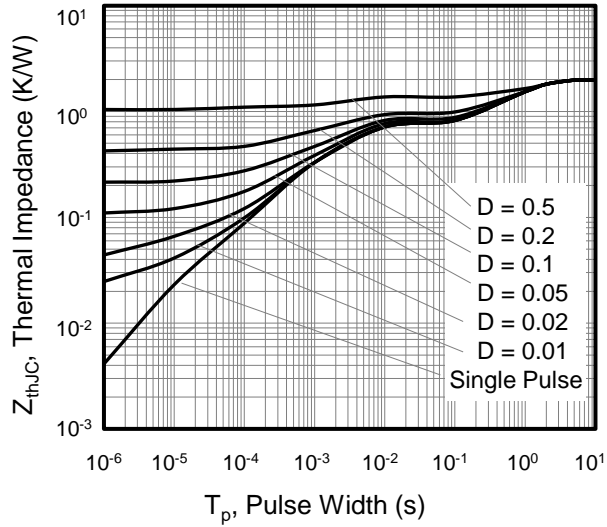

Figure A: Gate Charge Test Circuit and Waveform

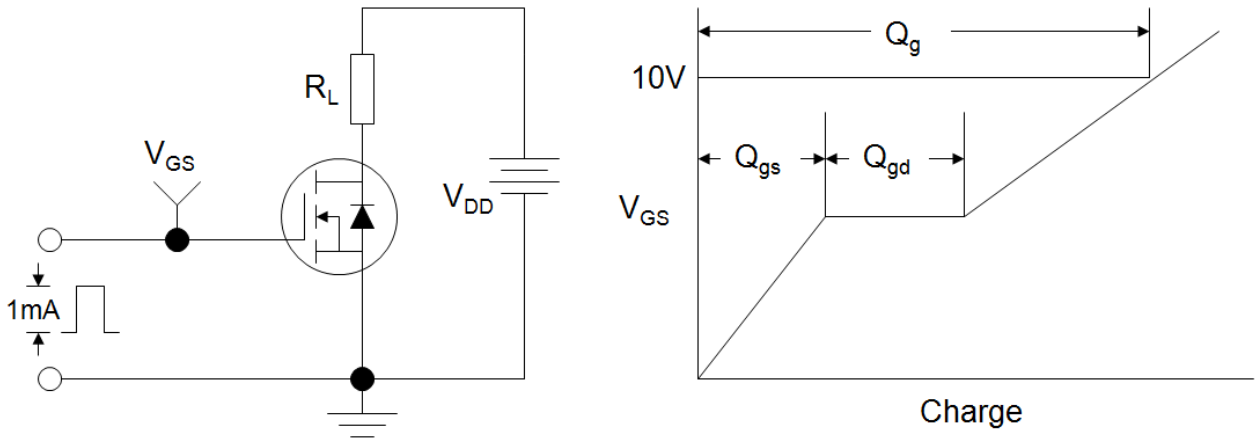

Figure B: Resistive Switching Test Circuit and Waveform

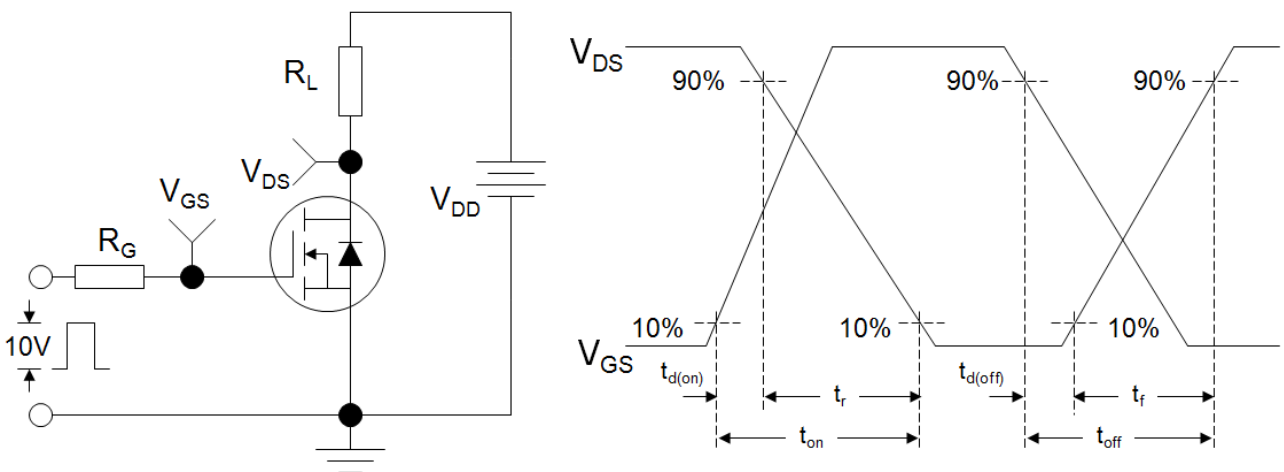
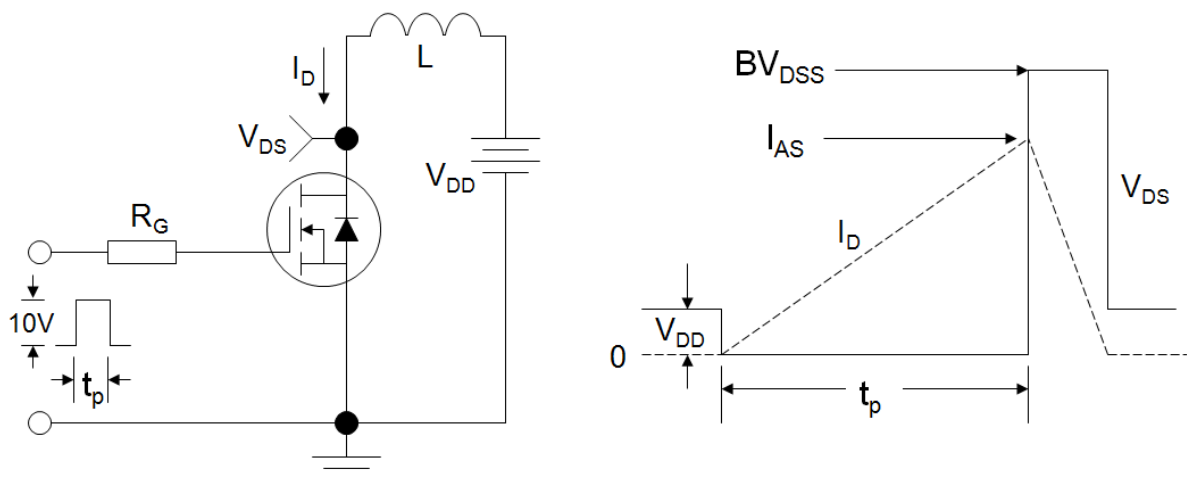
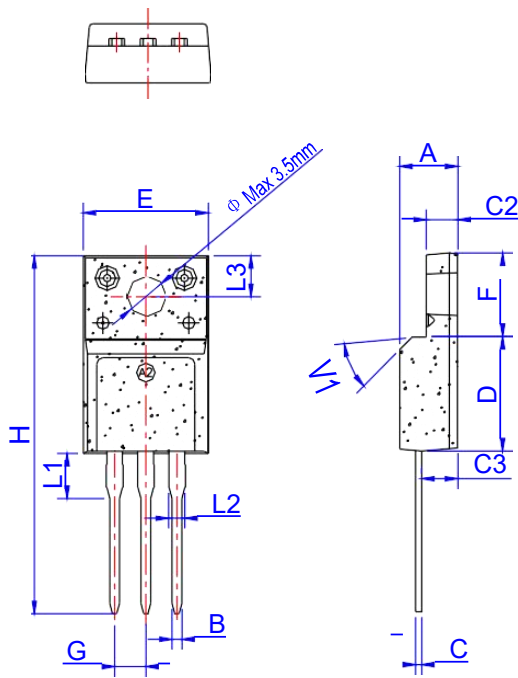

Figure C: Unclamped Inductive Switching Test Circuit and Waveform



TO-220F Package Mechanical Data



Ref.	Dimensions					
	Millimeters			Inches		
	Min.	Typ.	Max.	Min.	Typ.	Max.
A	4.50		4.90	0.177		0.193
B	0.74	0.80	0.83	0.029	0.031	0.033
C	0.47		0.65	0.019		0.026
C2	2.45		2.75	0.096		0.108
C3	2.60		3.00	0.102		0.118
D	8.80		9.30	0.346		0.366
E	9.80		10.4	0.386		0.410
F	6.40		6.80	0.252		0.268
G		2.54			0.1	
H	28.0		29.8	1.102		1.173
L1		3.63			0.143	
L2	1.14		1.70	0.045		0.067
L3		3.30			0.130	
V1		45°			45°	

Disclaimer:

The information provided in this document is believed to be accurate and reliable. however, Shenzhen Core Control Electronics Technology Co., Ltd. does not assume any responsibility for the following consequences Do not consider the use of such information or use beyond its scope.

The information mentioned in this document may be changed at any time without notice.

The products and information provided in this document do not infringe patents. Shenzhen Core Control Electronics Technology Co., Ltd. assumes no responsibility for any infringement of any other rights of third parties. The result of using such products and information.

This document is the first version issued on February 10, 2023. This document replaces and Replace all previously provided information.

 It is a registered trademark of Shenzhen Core Control Electronics Technology Co., Ltd.

Copyright © 2017 Shenzhen Core Control Electronics Technology Co., Ltd. all rights reserved.