

● General Description

The AGM15P22AS combines advanced trench MOSFET technology with a low resistance package to provide extremely low $R_{DS(ON)}$

This device is ideal for load switch and battery protection applications.

● Features

- Advance high cell density Trench technology
- Low $R_{DS(ON)}$ to minimize conductive loss
- Low Gate Charge for fast switching
- Low Thermal resistance
- 100% Avalanche tested
- 100% DVDS tested

● Application

- MB/VGA Vcore
- SMPS 2nd Synchronous Rectifier
- POL application
- BLDC Motor driver

Product Summary

BVDSS	RDS(ON)	ID
-16V	20mΩ	-9.0A

DFN2*2 Pin Configuration

Package Marking and Ordering Information

Device Marking	Device	Device Package	Reel Size	Tape width	Quantity
15P22	AGM15P22AS	DFN2*2	178mm	8mm	3000

Table 1. Absolute Maximum Ratings (TA=25°C)

Symbol	Parameter	Value	Unit
VDS	Drain-Source Voltage (VGS=0V)	-16	V
VGS	Gate-Source Voltage (VDS=0V)	±10	V
ID	Drain Current-Continuous(Tc=25°C) (Note 1)	-9.0	A
	Drain Current-Continuous(Tc=100°C)	-6.0	A
IDM (pluse)	Drain Current-Pulsed (Note 2)	-36	A
PD	Maximum Power Dissipation(Tc=25°C)	2.1	w
	Maximum Power Dissipation(Tc=100°C)	0.85	w
EAS	Avalanche energy (Note 3)	---	mJ
TJ,TSTG	Operating Junction and Storage Temperature Range	-55 To 150	°C

Table 2. Thermal Characteristic

Symbol	Parameter	Typ	Max	Unit
RθJA	Thermal Resistance Junction-ambient (Steady State) ¹	---	60	°C/W

Table 3. Electrical Characteristics (T_J=25°C unless otherwise noted)

Symbol	Parameter	Conditions	Min	Typ	Max	Unit
On/Off States						
BVDSS	Drain-Source Breakdown Voltage	VGS=0V ID=-250μA	-16	--	--	V
IDSS	Zero Gate Voltage Drain Current	VDS=-16V,VGS=0V	--	--	-1	μA
IGSS	Gate-Body Leakage Current	VGS=±10V,VDS=0V	--	--	±100	nA
VGS(th)	Gate Threshold Voltage	VDS=VGS,ID=-250μA	-0.4	-0.6	-1.0	V
gFS	Forward Transconductance	VDS=-5V,ID=-2A	--	5	--	S
RDS(on)	Drain-Source On-State Resistance	VGS=-4.5V, ID=-3A	--	20	27	mΩ
		VGS=-2.5V, ID=-2A	--	28	35	mΩ
Dynamic Characteristics						
Ciss	Input Capacitance	VDS=-10V,VGS=0V, F=1MHZ	--	728	--	pF
Coss	Output Capacitance		--	172	--	pF
Crss	Reverse Transfer Capacitance		--	164	--	pF
Rg	Gate resistance	VGS=0V, VDS=0V,f=1.0MHz	--	8	--	Ω
Switching Times						
td(on)	Turn-on Delay Time	ID =-5A VDS = -10V VGS =-4.5V RG = 8Ω	--	13	--	nS
tr	Turn-on Rise Time		--	36	--	nS
td(off)	Turn-Off Delay Time		--	32	--	nS
tf	Turn-Off Fall Time		--	12	--	nS
Qg	Total Gate Charge	VGS=-10V, VDS=-10V, ID=-5A	--	20	--	nC
Qgs	Gate-Source Charge		--	0.9	--	nC
Qgd	Gate-Drain Charge		--	3.2	--	nC
Source-Drain Diode Characteristics						
ISD	Source-Drain Current(Body Diode)		--	--	-9.0	A
VSD	Forward on Voltage	VGS=0V,IS=-3A	--	--	-1.2	V
trr	Reverse Recovery Time	Isd=-3A , dl/dt=100A/μs , TJ=25°C	--	--	--	ns
Qrr	Reverse Recovery Charge		--	--	--	nc

Notes 1.The maximum current rating is package limited.

Notes 2.Repetitive Rating: Pulse width limited by maximum junction temperature

Notes 3.EAS condition: T_J=25°C

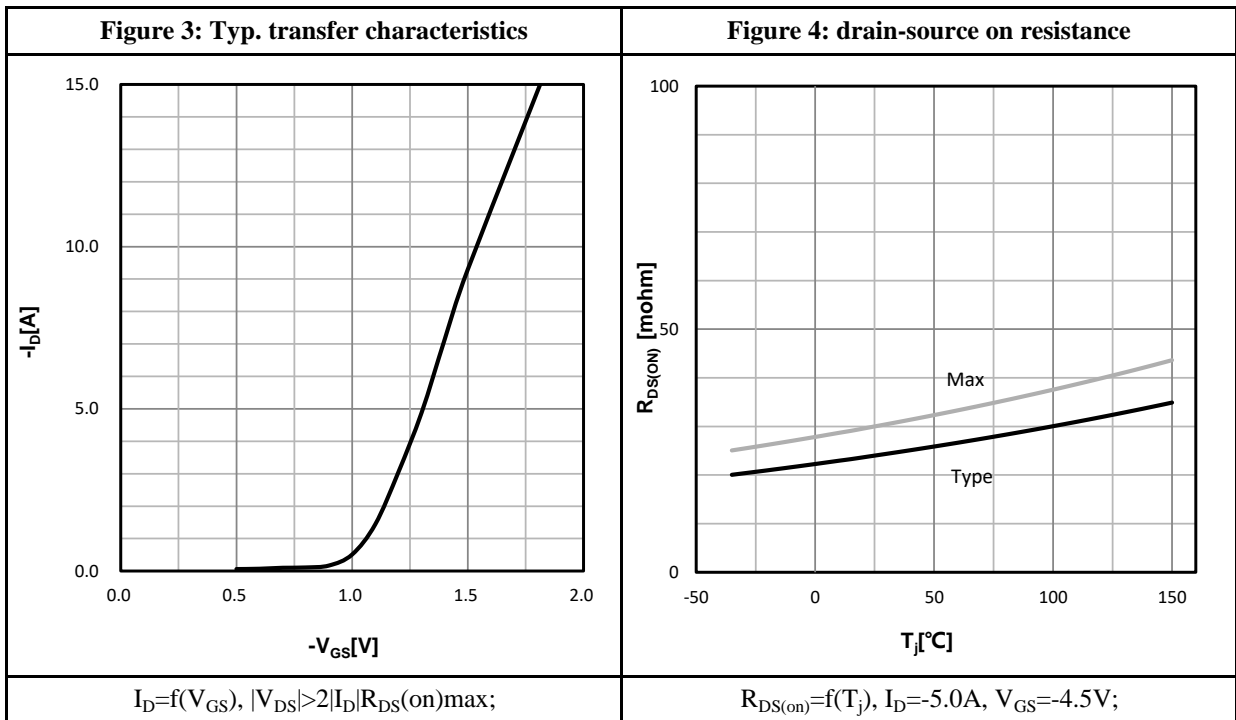
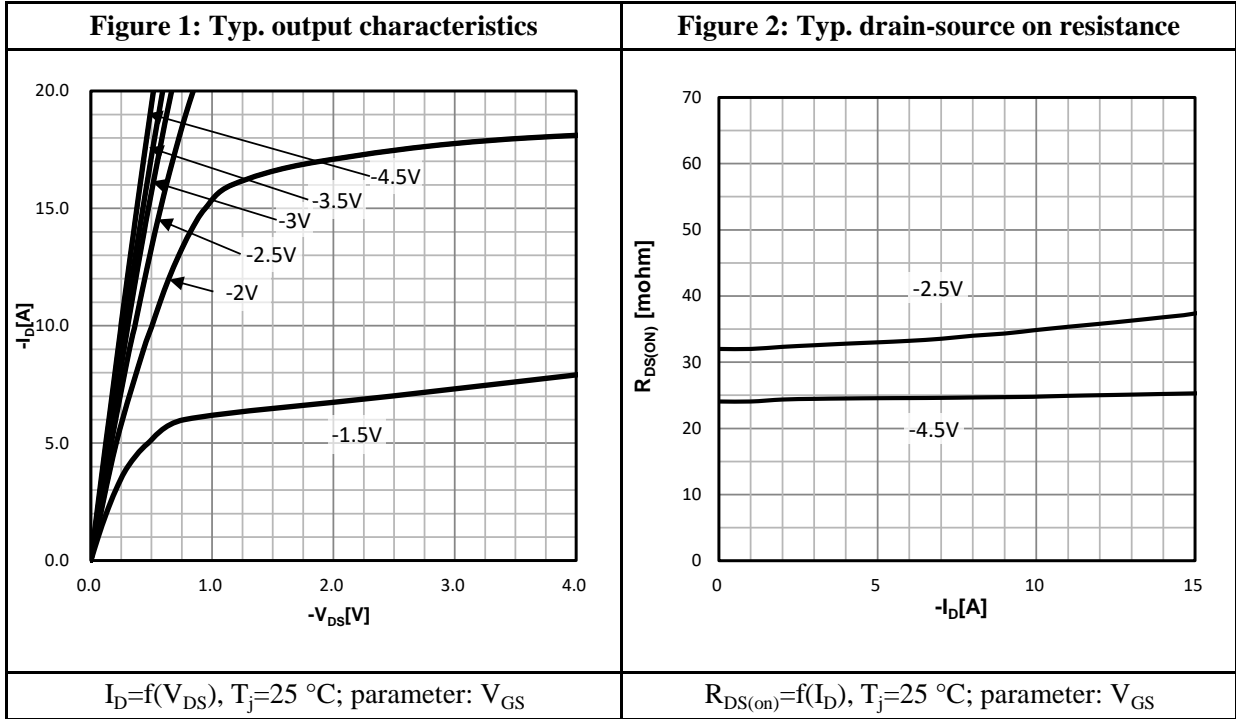
Characteristics Curve:

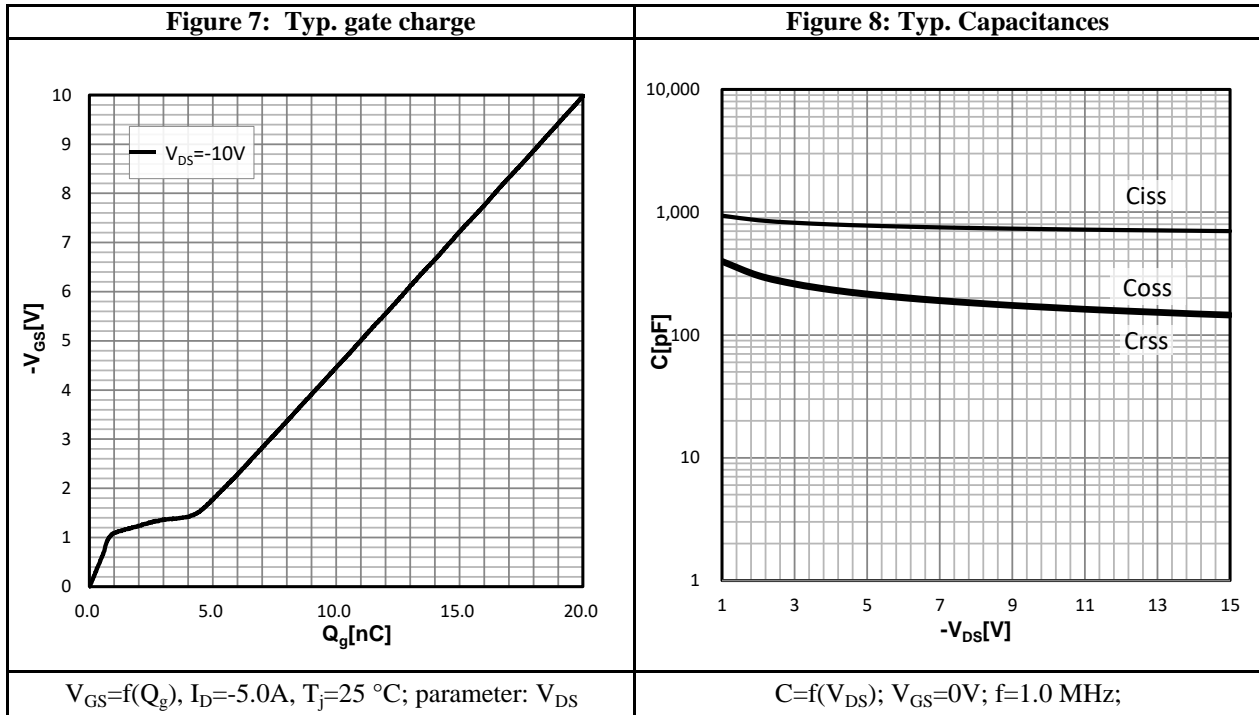
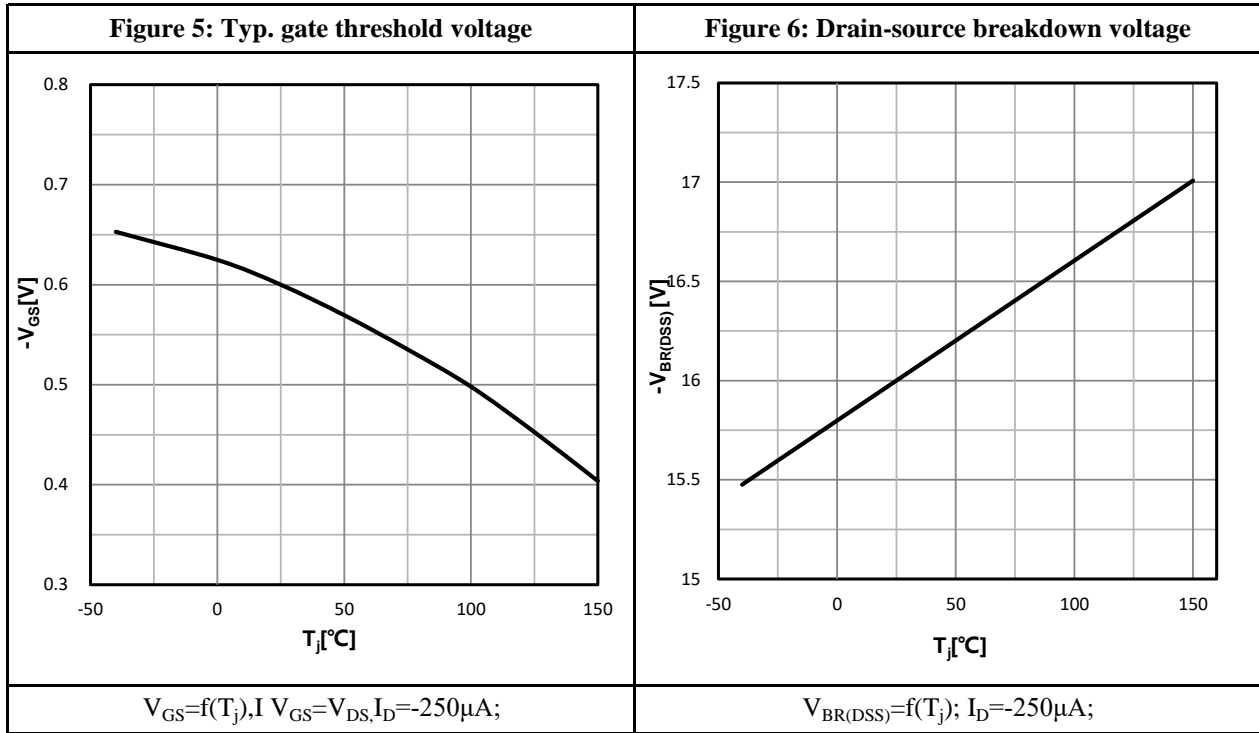

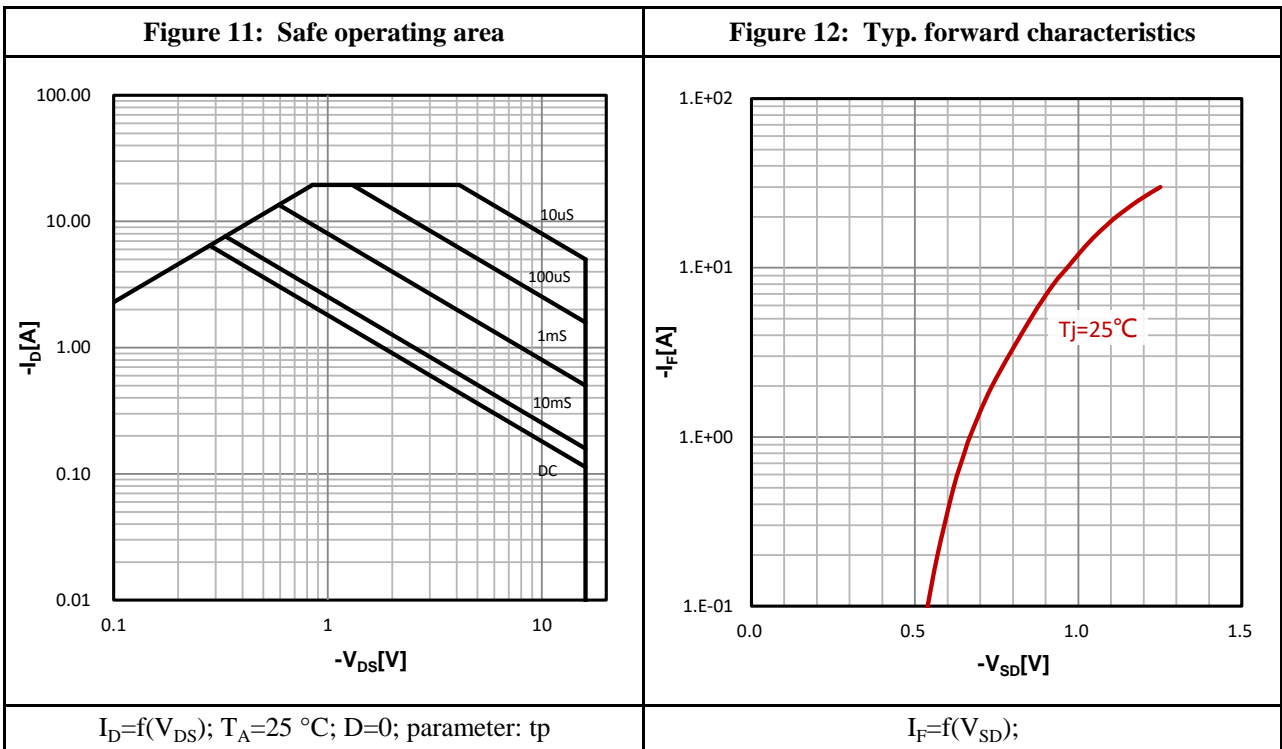
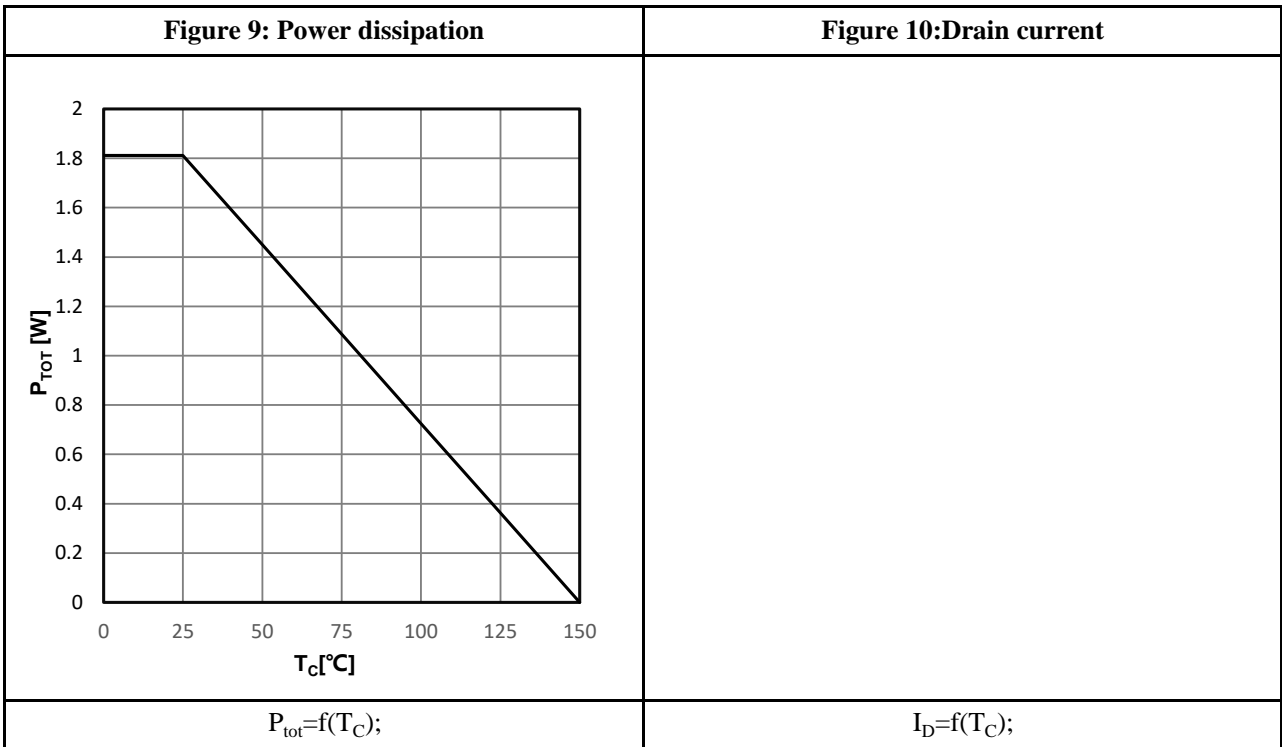

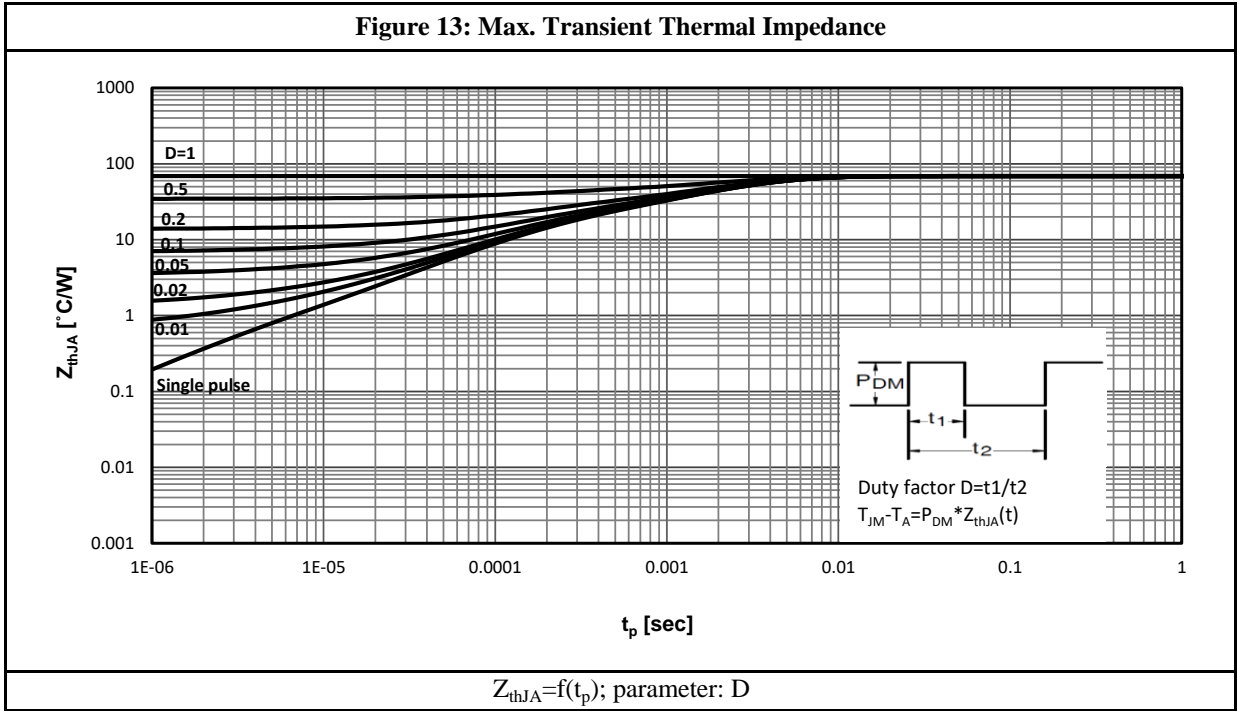

Test Circuit & Waveform:

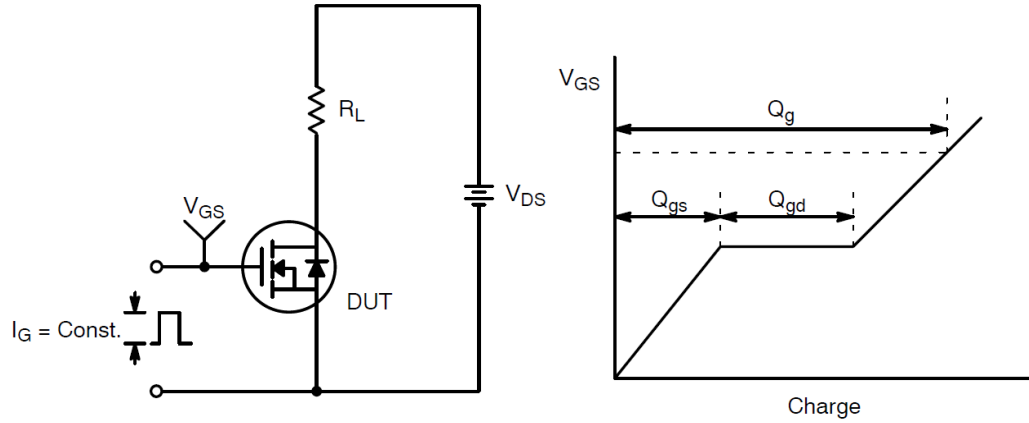

Figure 14: Gate Charge Test Circuit & Waveform

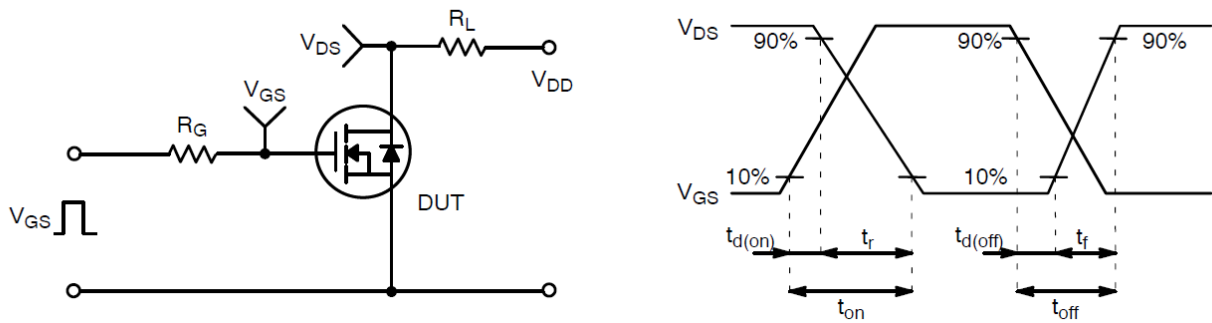

Figure 15: Resistive Switching Test Circuit & Waveforms

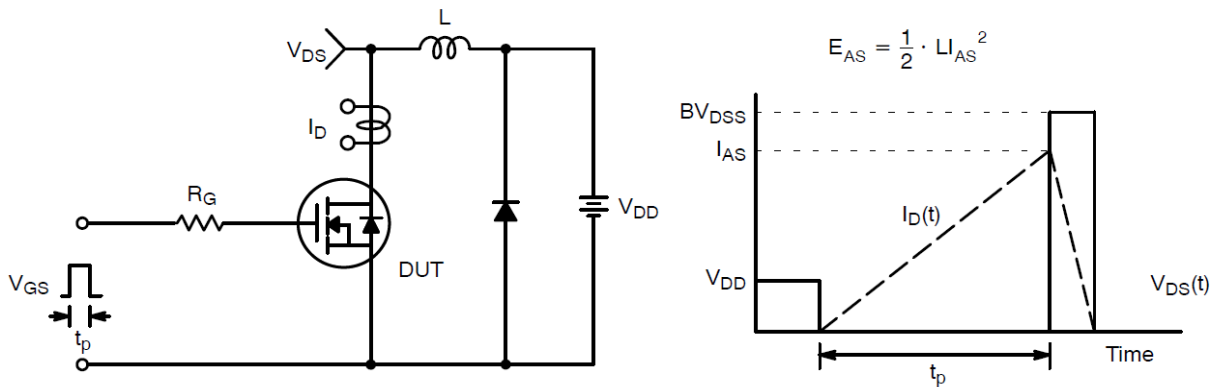
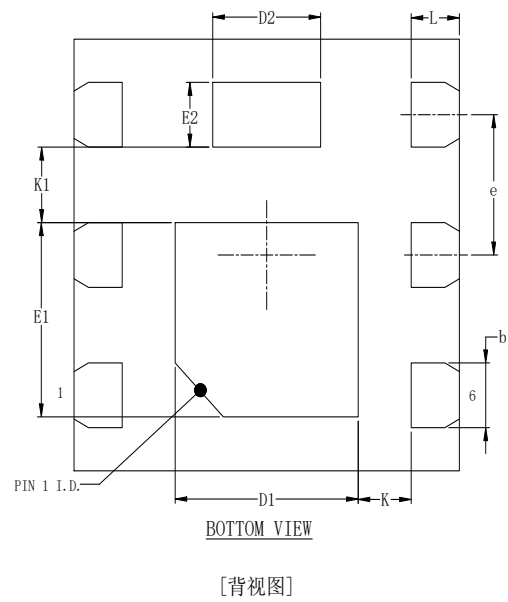
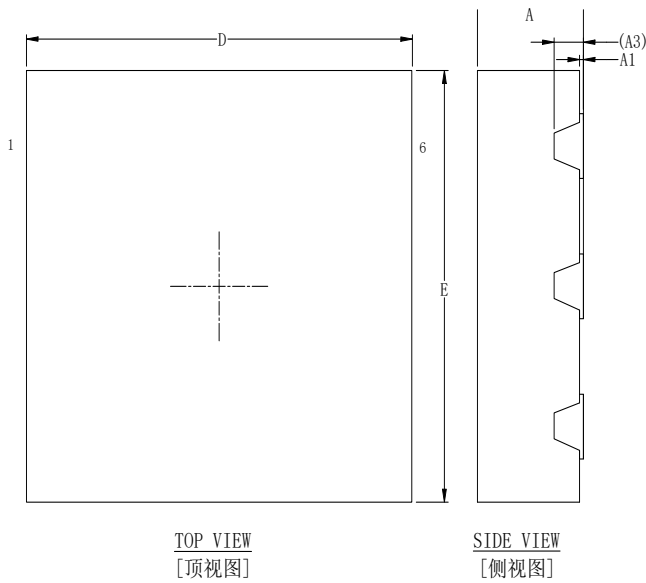
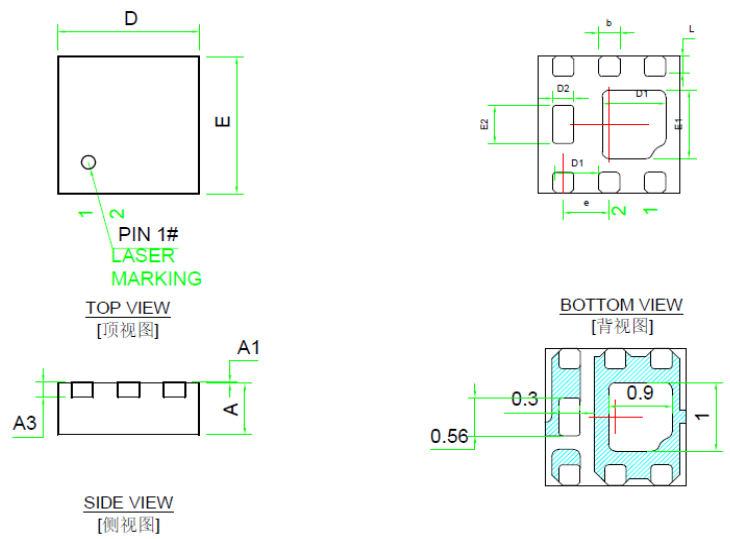

Figure 16: Unclamped Inductive Switching Test Circuit & Waveforms

•Dimensions (DFN2×2)

	SYMBOL	MIN	NOM	MAX	
TOTAL THICKNESS	A	0.5	0.55	0.6	
STAND OFF	A1	0	0.02	0.05	
L/F THICKNESS	A3	0.152 REF			
LEAD WIDTH	b	0.25	0.3	0.35	
BODY SIZE	X	D	1.9	2	2.1
	Y	E	1.9	2	2.1
LEAD PITCH	e	0.65 BSC			
EP SIZE	X	D1	0.85	0.95	1.05
		D2	0.46	0.56	0.66
	Y	E1	0.8	0.9	1
		E2	0.2	0.3	0.4
LEAD LENGTH	L	0.2	0.25	0.3	
LEAD TIP TO EP EDGE	K	0.275 REF			
EP EDGE TO EP EDGE	K1	0.35 REF			



Symbol	Dimensions In Millimeters		
	Min	Nom	Max
A	0.700	0.750	0.800
A1	0.000	0.020	0.050
A3	0.203REF		
b	0.250	0.300	0.350
D	1.900	2.000	2.100
D1	0.850	0.900	0.950
D2	0.250	0.300	0.350
e	0.650BSC		
E	1.900	2.000	2.100
E1	0.950	1.000	1.050
E2	0.510	0.560	0.610
L	0.250	0.300	0.350

Disclaimer:

The information provided in this document is believed to be accurate and reliable. however, Shenzhen Core Control Electronics Technology Co., Ltd. does not assume any responsibility for the following consequences. Do not consider the use of such information or use beyond its scope.

The information mentioned in this document may be changed at any time without notice.

The products and information provided in this document do not infringe patents. Shenzhen Core Control Electronics Technology Co., Ltd. assumes no responsibility for any infringement of any other rights of third parties. The result of using such products and information.

This document is the second version issued on Jan. 10th, 2024. This document replaces all previously provided information.

 It is a registered trademark of Shenzhen Core Control Electronics Technology Co., Ltd.

Copyright © 2017 Shenzhen Core Control Electronics Technology Co., Ltd. all rights reserved.