

HIGH SENSITIVITY MICROPOWER UNIPOLAR/OMNIPOLAR SELECTABLE HALL-EFFECT SWITCH

NEW PRODUCT

Description

The AH1903 is a high sensitivity micropower Omnipolar or Unipolar selectable Hall effect switch IC with internal pull up and pull down capability. Designed for battery powered consumer equipment such as cellular phones and portable PCs to office equipment, home appliances and industrial applications, the average supply current is only 4.3 μ A at 1.8V. To support portable equipment the AH1903 can operate over the supply range of 1.6V to 3.6V and uses a hibernating clocking system to minimize the power consumption. To minimize PCB space the AH1903 is available in a small low profile X1-DFN1216-4 package.

The user can change the Hall switch function between Unipolar and Omnipolar operation via the Select (SEL) pin. If the SEL pin is open circuit or pulled high the AH1903 operates in Unipolar switch mode detecting magnetic field direction with a South pole to the part mark side of the package. If the SEL pin is pulled low the AH1903 functions as a Omnipolar switch detecting either a North or South pole. The output is activated with a pole of sufficient magnetic field strength. When the magnetic flux density (B) perpendicular to the package is larger than operate point (Bop), the output will be turned on (pulled low) and held until B is lower than release point (Brp).

Features

- Unipolar or Omnipolar Operation
 - Operation can be changed by a logic source or fixed via PCB design with no additional components
- Supply Voltage of 1.6V to 3.6V
- High Sensitivity
- Micropower Operation
- Chopper Stabilized Design Provides
 - Superior Temperature Stability
 - Minimal Switch Point Drift
 - Enhanced Immunity to Physical Stress
- No External Pull-up Resistors Required
- Good RF Noise Immunity
- -40°C to +85°C Operating Temperature
- High ESD capability of 8kV (Human Body Model) on V_{DD}, GND and OUTPUT Pins
- Small Low Profile X1-DFN1216-4 Package
- **Totally Lead-Free & Fully RoHS Compliant (Notes 1 & 2)**
- **Halogen and Antimony Free. "Green" Device (Note 3)**

- Notes:
1. No purposely added lead. Fully EU Directive 2002/95/EC (RoHS) & 2011/65/EU (RoHS 2) compliant.
 2. See http://www.diodes.com/quality/lead_free.html for more information about Diodes Incorporated's definitions of Halogen- and Antimony-free, "Green" and Lead-free.
 3. Halogen- and Antimony-free "Green" products are defined as those which contain <900ppm bromine, <900ppm chlorine (<1500ppm total Br + Cl) and <1000ppm antimony compounds.
 4. C_{IN} is for power stabilization and to strengthen the noise immunity, the recommended capacitance is 100nF typical and should be placed as close to the supply pin as possible.

Pin Assignments

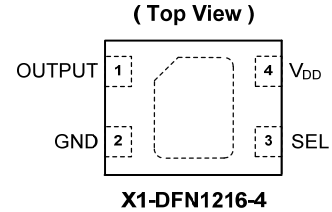

Applications

- Open and Close Detect for flip/slide Cellular Phones
- Smart Cover or Dock Detect for Cellular Phones and Tablet PCs
- Cover or Display Switch in Portable PCs (eg Ultrabook)
- Digital Still, Video Cameras and Handheld Gaming Consoles
- Door, Lids and Tray Position Switches
- Level, Proximity and Position Switches
- Contact-Less Switches in Home Appliances and Industrial Applications

Typical Application Circuit

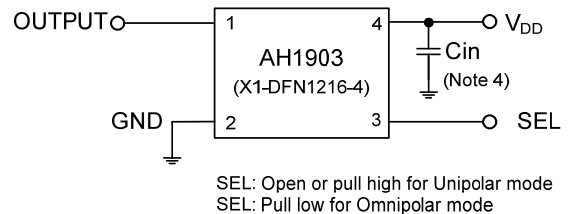

Pin Descriptions

Package: X1-DFN1216-4

Pin Number	Pin Name	Function
1	OUTPUT	Output Pin
2	GND	Ground Pin
3	SEL	Unipolar or Omnipolar Operation Select Pin; For Unipolar operation, pull-up the SEL pin to V_{DD} or leave it unconnected. The SEL pin is internally pulled high. For Omnipolar operation, connect the SEL pin to GND.
4	V_{DD}	Power Supply Input
Pad	Pad	The center exposed pad - It is internally connected to V_{DD} pin and should not be connected to GND or any other signal on the PCB. The exposed pad should be left open (unconnected) on the PCB layout.

Functional Block Diagram

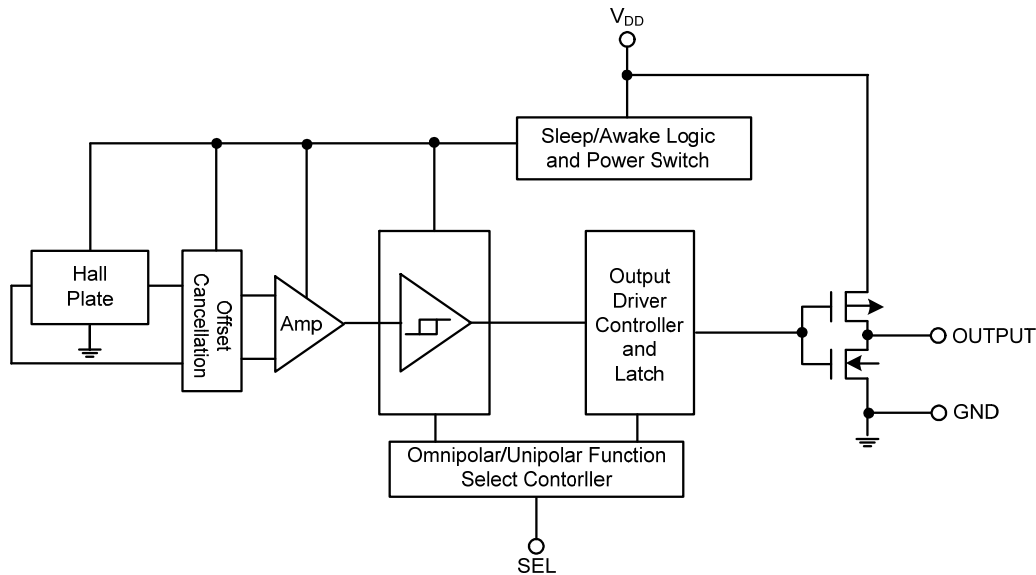

Absolute Maximum Ratings (Note 5) (@ $T_A = +25^\circ\text{C}$, unless otherwise specified.)

Symbol	Parameter	Rating	Unit	
V_{DD}	Supply Voltage (Note 6)	6	V	
V_{DD_REV}	Reverse Supply Voltage	-0.3	V	
I_{OUTPUT}	Output current (source and sink)	3	mA	
B	Magnetic Flux Density	Unlimited		
P_D	Package Power Dissipation	X1-DFN1216-4	230	mW
T_s	Storage Temperature Range	-65 to +150	$^\circ\text{C}$	
T_J	Maximum Junction Temperature	150	$^\circ\text{C}$	
ESD HBM	Human Body Model (HBM) ESD capability	V_{DD} , GND and OUTPUT pins	8	kV
		Logic SEL pin	6	kV

- Notes:
- Stresses greater than the 'Absolute Maximum Ratings' specified above may cause permanent damage to the device. These are stress ratings only; functional operation of the device at these or any other conditions exceeding those indicated in this specification is not implied. Device reliability may be affected by exposure to absolute maximum rating conditions for extended periods of time.
 - The absolute maximum V_{DD} of 6V is a transient stress rating and is not meant as a functional operating condition. It is not recommended to operate the device at the absolute maximum rated conditions for any period of time.

Recommended Operating Conditions (@ $T_A = +25^\circ\text{C}$, unless otherwise specified.)

Symbol	Parameter	Conditions	Rating	Unit
V_{DD}	Supply Voltage	Operating	1.6V to 3.6V	V
T_A	Operating Temperature Range	Operating	-40 to +85	$^\circ\text{C}$

Electrical Characteristics (@ $T_A = +25^\circ\text{C}$, $V_{DD} = 1.8\text{V}$, unless otherwise specified.)

Symbol	Parameter	Conditions	Min	Typ	Max	Unit
V_{OL}	Output Low Voltage (on)	$I_{OUT} = 1\text{mA}$	—	0.1	0.2	V
V_{OH}	Output High Voltage (off)	$I_{OUT} = -1\text{mA}$	$V_{DD} - 0.2$	$V_{DD} - 0.1$	—	V
SEL Low	Omnipolar operation selected		0	—	0.5	V
SEL High	Unipolar operation selected		1.4	—	3.6	V
$R_{U\ SEL}$	BSEL pin internal pull-up resistor	(Note 7)	—	50		k Ω
I_{off}	Output Leakage Current	$V_{OUT} = 3.6\text{V}$, Output off	—	< 0.1	1	μA
$I_{DD}(\text{awake})$	Supply Current	During 'awake' period, $T_A = +25^\circ\text{C}$, $V_{DD} = 3\text{V}$	—	2.1	—	mA
$I_{DD}(\text{sleep})$		During 'sleep' period, $T_A = +25^\circ\text{C}$, $V_{DD} = 3\text{V}$	—	2.5	—	μA
$I_{DD}(\text{avg})$	Average Supply Current	$T_A = +25^\circ\text{C}$, $V_{DD} = 1.8\text{V}$	—	4.3	8	μA
		$T_A = +25^\circ\text{C}$, $V_{DD} = 3.6\text{V}$	—	7.2	13	μA
T_{awake}	Awake Time	(Note 8)	—	50	100	μs
T_{period}	Period	(Note 8)	—	50	100	ms
D.C.	Duty Cycle		—	0.1	—	%

- Notes:
- SEL pin internal pull-up resistor is only active during AWAKE time.
 - When power is initially on, the operating V_{DD} (1.6V to 3.6V) must be applied to guarantee the output sampling. The output state is valid after the second operating phase (typical 100ms).

Electrical Characteristics (cont.)

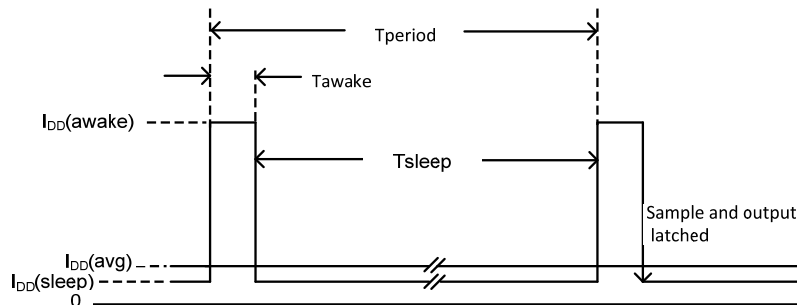

Magnetic Characteristics (Notes 9 & 10) ($T_A = +25^\circ\text{C}$, $V_{DD} = 1.8\text{V}$, unless otherwise specified)

Unipolar Operation: SEL = High ($> 1.4\text{V}$ to V_{DD} or No connection)

(1mT=10 Gauss)

Symbol	Characteristics	Test Condition	Min	Typ	Max	Unit
Bops (south pole to part marking side)	Operation Point		23	33	47	Gauss
		$V_{DD} = 1.6\text{V to } 3.6\text{V}$ $T_A = -40^\circ\text{C to } +85^\circ\text{C}$	21	33	48	
Brps (south pole to part marking side)	Release Point		12	23	35	
		$V_{DD} = 1.6\text{V to } 3.6\text{V}$ $T_A = -40^\circ\text{C to } +85^\circ\text{C}$	9	23	38	
Bhy ($ B_{opx} - B_{rpx} $)	Hysteresis		—	10	—	

Omnipolar Operation: SEL = Low (GND or $< 0.5\text{V}$)

(1mT=10 Gauss)

Symbol	Characteristics	Test Condition	Min	Typ	Max	Unit
Bops (south pole to part marking side)	Operation Point		23	33	47	Gauss
		$V_{DD} = 1.6\text{V to } 3.6\text{V}$ $T_A = -40^\circ\text{C to } +85^\circ\text{C}$	21	33	48	
Bopn (north pole to part marking side)			-47	-33	-23	
		$V_{DD} = 1.6\text{V to } 3.6\text{V}$ $T_A = -40^\circ\text{C to } +85^\circ\text{C}$	-48	-33	-21	
Brps (south pole to part marking side)	Release Point		12	23	35	
		$V_{DD} = 1.6\text{V to } 3.6\text{V}$ $T_A = -40^\circ\text{C to } +85^\circ\text{C}$	9	23	38	
Brpn (north pole to part marking side)			-35	-23	-12	
		$V_{DD} = 1.6\text{V to } 3.6\text{V}$ $T_A = -40^\circ\text{C to } +85^\circ\text{C}$	-38	-23	-9	
Bhy ($ B_{opx} - B_{rpx} $)	Hysteresis		—	10	—	

 Notes: 9. Typical data is at $T_A = +25^\circ\text{C}$, $V_{DD} = 1.8\text{V}$.

10. Maximum and minimum parameters values over operating temperature range are not tested in production, they are guaranteed by design, characterization and process control. The magnetic characteristics may vary with supply voltage, operating temperature and after soldering.

Application Notes

The AH1903 includes a Hall switch function select pin (SEL) so that the AH1903 can be changed between an Unipolar or an Omnipolar Hall Switch operation to fit a multitude of applications. The diagrams below show the different switching functions between the Unipolar and the Omnipolar Hall switch types.

AH1903 in Unipolar Operation

In Unipolar mode, the sensor detects the magnetic flux density perpendicular to the part marking surface with magnetic field direction only from the back to the front of the package as shown below. This magnetic field direction is similar to having a South pole on the part marking side or a North pole to the back of the package.

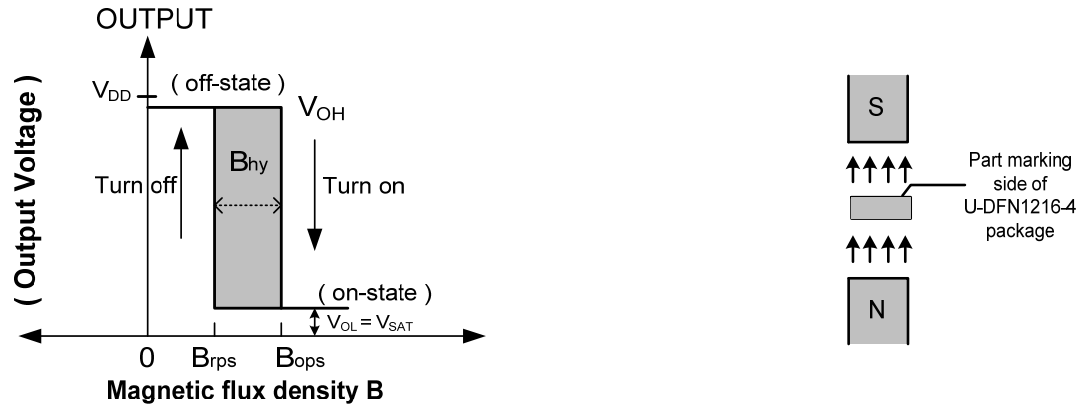

Magnetic Field Direction for Unipolar Mode Operation

AH1903 in Omnipolar Operation

In Omnipolar mode, the sensor detects the magnetic flux density perpendicular to the part marking surface with magnetic field directions from the front to the back as well as from the back to the front of the package as shown below. The sensor detects both North or South pole to the part marking side or to the back of the package.

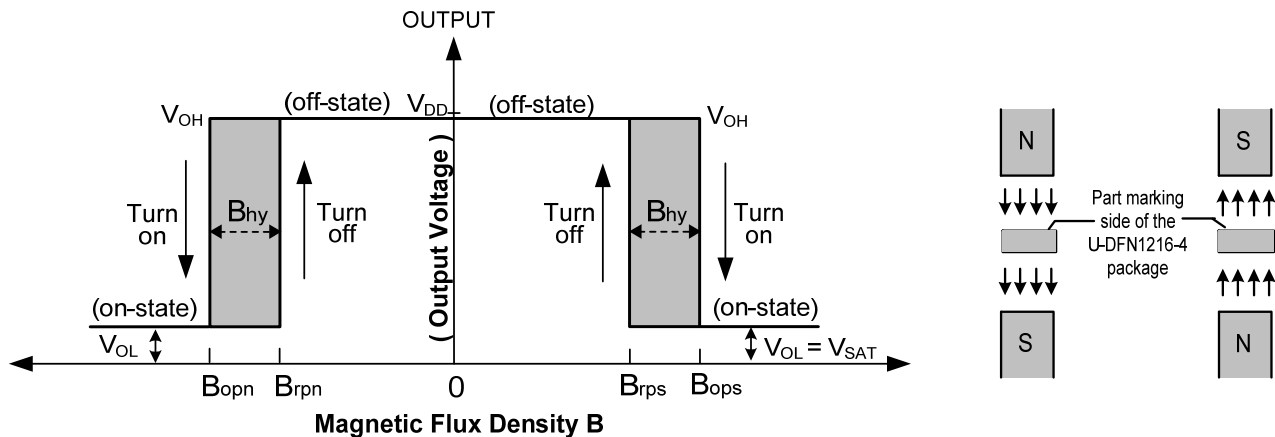

Magnetic Field Directions for Omnipolar Mode Operation

The AH1903 includes a function select pin (SEL) to change the device type between Unipolar and Omnipolar operations. The SEL pin can be hard wired within the application circuit or can be changed on the fly by using the SEL pin as a logic input. This feature allows the AH1903 operating mode to be changed by firmware within the application without the addition of any external components. If the SEL pin is left open circuit the AH1903 defaults to Unipolar mode.

Application Notes (cont.)

Applications Circuit 1 – Unipolar Operation

Connecting the SEL pin to V_{DD} , a voltage greater than 1.4V or leaving the SEL pin unconnected configures the AH1903 into Unipolar mode, only detecting South pole of sufficient strength from the part mark side of the package. In Unipolar mode, North pole fields will not switch on the output.

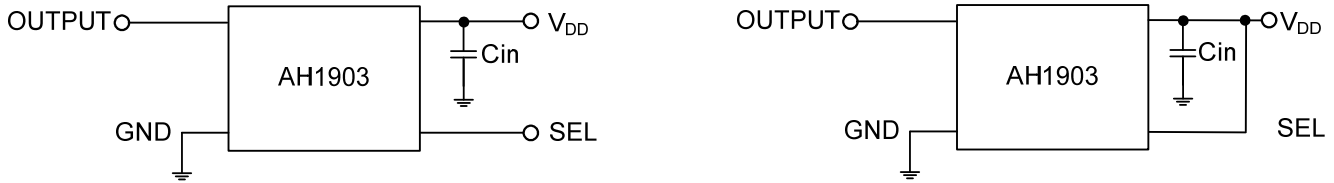

Applications Circuit 2 – Omnipolar Operation

Connecting the SEL pin to ground configures the AH1903 into Omnipolar mode, detecting both North and South magnetic fields of sufficient strength.

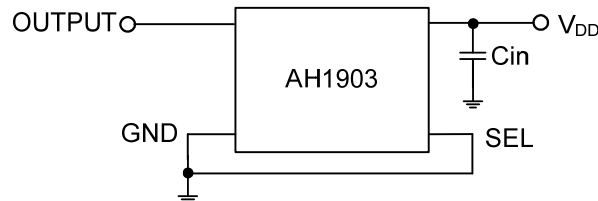

Applications Circuit 3 – Adjustable Sensor Type

To enhance flexibility within the application the sensor operation modes can be selected with a standard logic signal allowing it to be controlled by a micro-controller or a logic source. This allows the sensor type to be changed within the application without a hardware change. Whenever the Hall switch type is changed, the selection changeover should allow two awake period for the output to be valid.

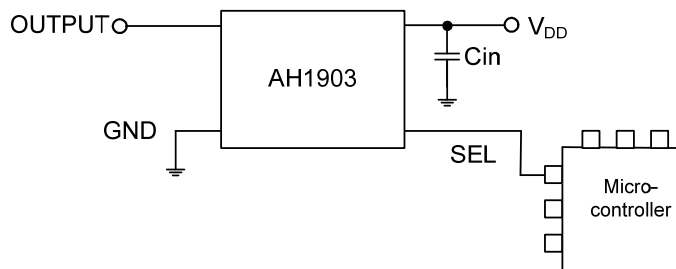

Sensor Type Change Timing and Valid Output

Whenever type selection SEL input is changed, allow for band selection changeover to complete and stabilize. The output is valid only after the second complete operating 'awake' phase. Time taken for the output to be valid, after the SEL change, depends on timing of SEL change during the sleep and awake phase; this time can range from 100ms typical and 200.1ms maximum.

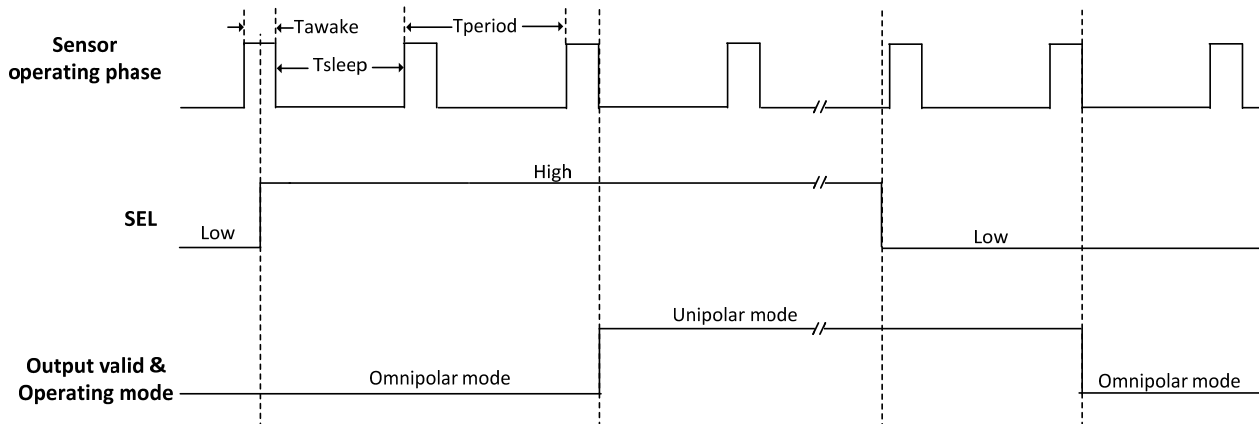

Typical Operating Characteristics

Operating Switch Points in Unipolar Operation (SEL = No connection or SEL = V_{DD})

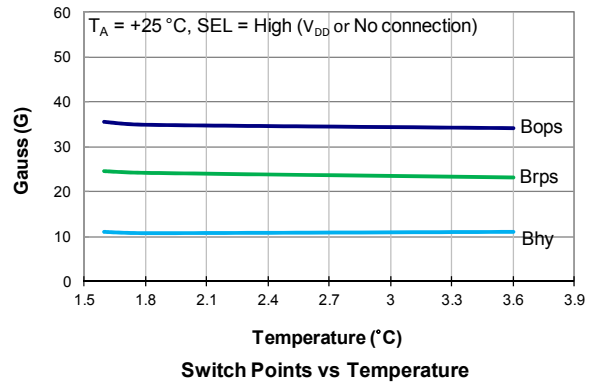
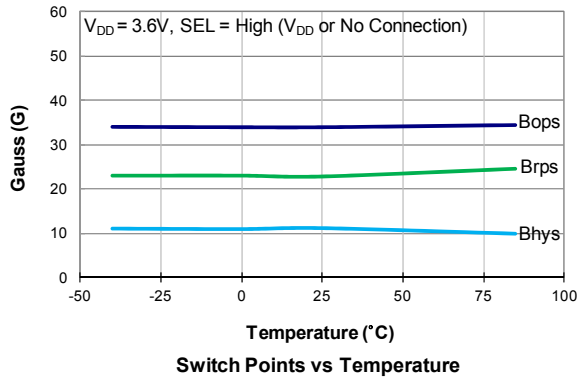
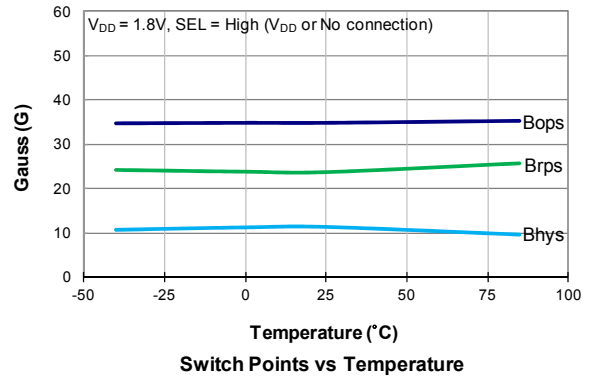
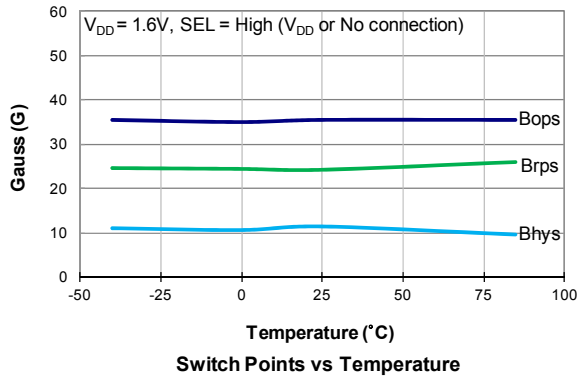

NEW PRODUCT

Typical Operating Characteristics (cont.)

Operating Switch Points in Omnipolar Operation (SEL = GND)

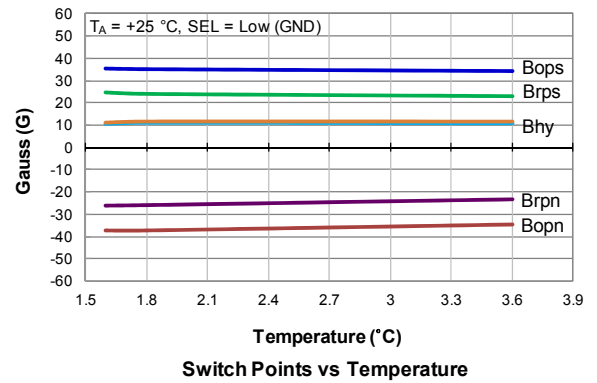
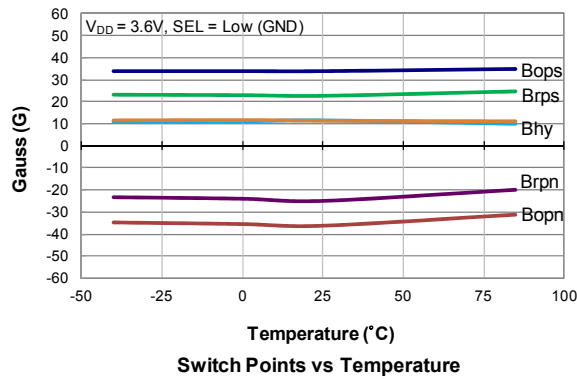
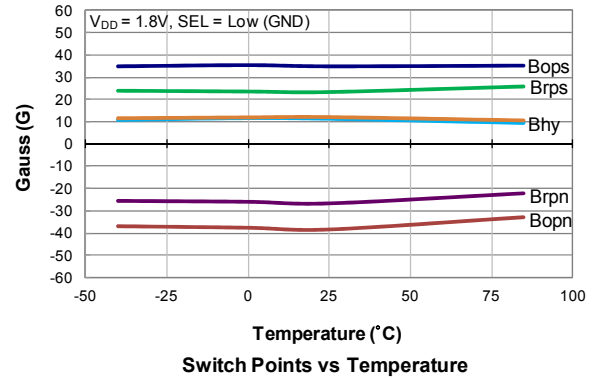
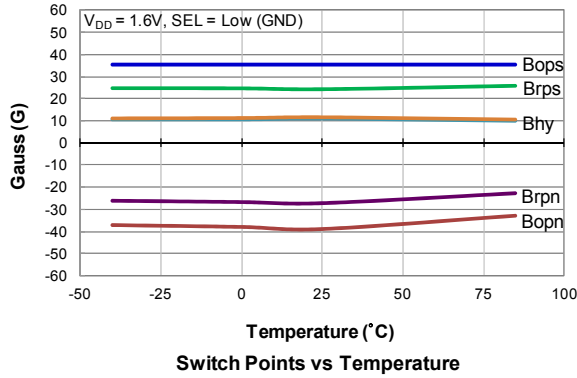

Average Supply Current - Unipolar or Omnipolar Operations

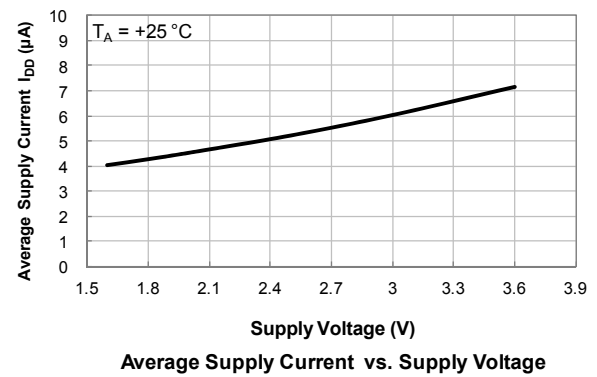
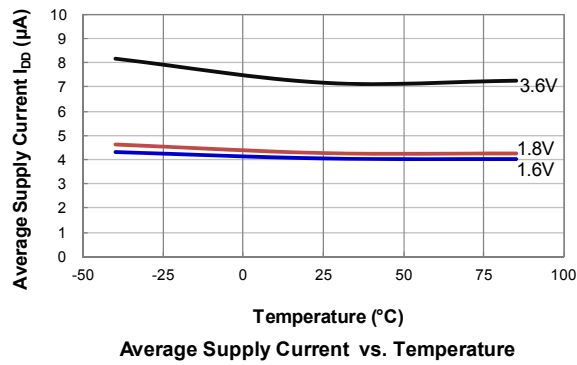

Ordering Information

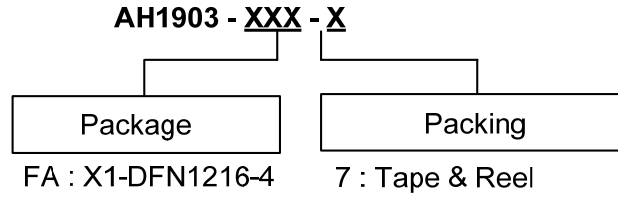

Part Number	Package Code	Packaging	7" Tape and Reel	
			Quantity	Part Number Suffix
AH1903-FA-7	FA	X1-DFN1216-4	3000/Tape & Reel	-7

Marking Information

(1) Package Type: X1-DFN1216-4

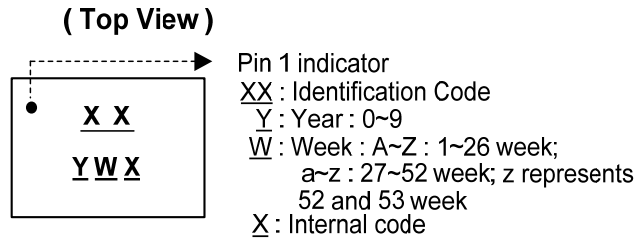

Part Number	Package	Identification Code
AH1903-FA-7	X1-DFN1216-4	F3

Package Outline Dimensions (All dimensions in mm.)

Please see AP02002 at <http://www.diodes.com/datasheets/ap02002.pdf> for latest version.

(1) Package Type: X1-DFN1216-4

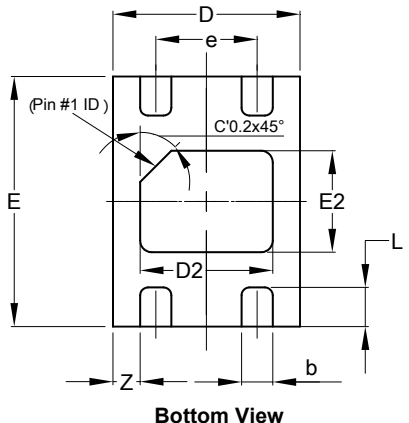
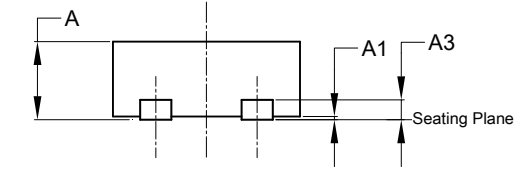

X1-DFN1216-4			
Dim	Min	Max	Typ
A	0.47	0.53	0.50
A1	0.00	0.05	0.02
A3	--	--	0.13
b	0.15	0.25	0.20
D	1.15	1.25	1.20
D2	0.75	0.95	0.85
E	1.55	1.65	1.60
E2	0.55	0.75	0.65
e	-	-	0.65
L	0.20	0.30	0.25
Z	-	-	0.175
All Dimensions in mm			

Bottom View

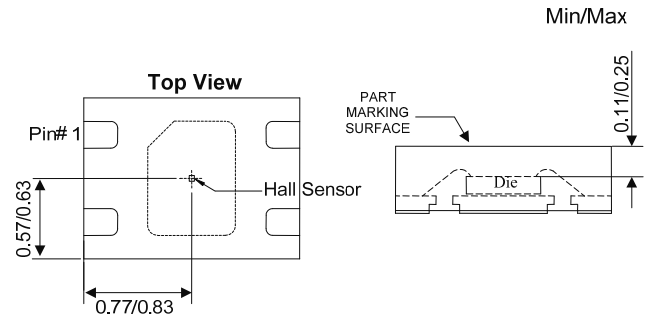

Sensor Location (To be confirmed)

Suggested Pad Layout

Please see AP02001 at <http://www.diodes.com/datasheets/ap02001.pdf> for the latest version.

(1) Package Type: X1-DFN1216-4

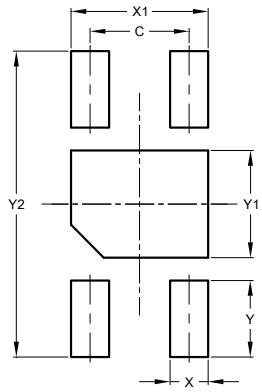

Dimensions	Value
C	0.65
X	0.25
X1	0.90
Y	0.50
Y1	0.70
Y2	2.00
All Dimensions in mm	

NEW PRODUCT

IMPORTANT NOTICE

DIODES INCORPORATED MAKES NO WARRANTY OF ANY KIND, EXPRESS OR IMPLIED, WITH REGARDS TO THIS DOCUMENT, INCLUDING, BUT NOT LIMITED TO, THE IMPLIED WARRANTIES OF MERCHANTABILITY AND FITNESS FOR A PARTICULAR PURPOSE (AND THEIR EQUIVALENTS UNDER THE LAWS OF ANY JURISDICTION).

Diodes Incorporated and its subsidiaries reserve the right to make modifications, enhancements, improvements, corrections or other changes without further notice to this document and any product described herein. Diodes Incorporated does not assume any liability arising out of the application or use of this document or any product described herein; neither does Diodes Incorporated convey any license under its patent or trademark rights, nor the rights of others. Any Customer or user of this document or products described herein in such applications shall assume all risks of such use and will agree to hold Diodes Incorporated and all the companies whose products are represented on Diodes Incorporated website, harmless against all damages.

Diodes Incorporated does not warrant or accept any liability whatsoever in respect of any products purchased through unauthorized sales channel. Should Customers purchase or use Diodes Incorporated products for any unintended or unauthorized application, Customers shall indemnify and hold Diodes Incorporated and its representatives harmless against all claims, damages, expenses, and attorney fees arising out of, directly or indirectly, any claim of personal injury or death associated with such unintended or unauthorized application.

Products described herein may be covered by one or more United States, international or foreign patents pending. Product names and markings noted herein may also be covered by one or more United States, international or foreign trademarks.

This document is written in English but may be translated into multiple languages for reference. Only the English version of this document is the final and determinative format released by Diodes Incorporated.

LIFE SUPPORT

Diodes Incorporated products are specifically not authorized for use as critical components in life support devices or systems without the express written approval of the Chief Executive Officer of Diodes Incorporated. As used herein:

A. Life support devices or systems are devices or systems which:

1. are intended to implant into the body, or
2. support or sustain life and whose failure to perform when properly used in accordance with instructions for use provided in the labeling can be reasonably expected to result in significant injury to the user.

B. A critical component is any component in a life support device or system whose failure to perform can be reasonably expected to cause the failure of the life support device or to affect its safety or effectiveness.

Customers represent that they have all necessary expertise in the safety and regulatory ramifications of their life support devices or systems, and acknowledge and agree that they are solely responsible for all legal, regulatory and safety-related requirements concerning their products and any use of Diodes Incorporated products in such safety-critical, life support devices or systems, notwithstanding any devices- or systems-related information or support that may be provided by Diodes Incorporated. Further, Customers must fully indemnify Diodes Incorporated and its representatives against any damages arising out of the use of Diodes Incorporated products in such safety-critical, life support devices or systems.

Copyright © 2014, Diodes Incorporated

www.diodes.com