

Linear Hall-Effect Sensors

■ Features

- Extremely Sensitive
- Flat Response to 23 KHz
- Low-Noise Output
- 4.5V to 6V Operation
- SIP-3L and SOT23-3L Package

■ Application

- Gear tooth Sensor
- Notch Sensor
- Current Sensor

■ Pin Assignment

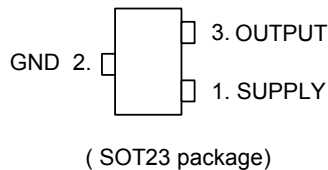
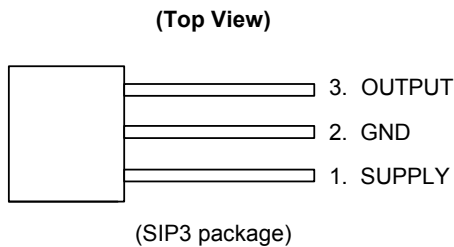

■ Ordering Information

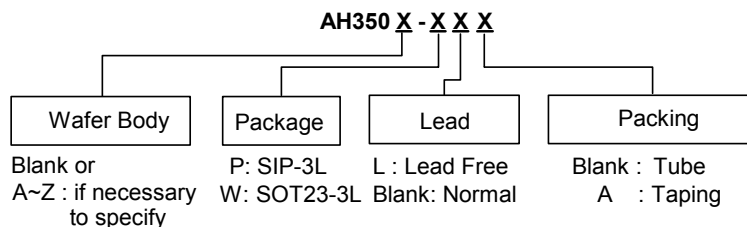

■ General Description

The AH350 Hall-effect sensors accurately track extremely small changes in magnetic flux density—changes are generally too small to operate Hall-effect switches.

As motion detectors, gear tooth sensors, and proximity detectors, they are magnetically driven mirrors of mechanical events. As sensitive monitors of electromagnets, they can effectively measure system's performance with negligible system loading while providing isolation from contaminated and electrically noisy environments.

Each Hall-effect integrated circuit includes a Hall sensing element, linear amplifier, and emitter-follower output stage. Having the Hall cell and amplifier on a single chip minimizes problems associated with handling tiny analog signals.

The device is rated for continuous operation over the temperature range of -20°C to +85°C.

■ Pin Configuration

Name	Description
SUPPLY	Input power
GND	Ground
OUTPUT	Output stage

Linear Hall-Effect Sensors

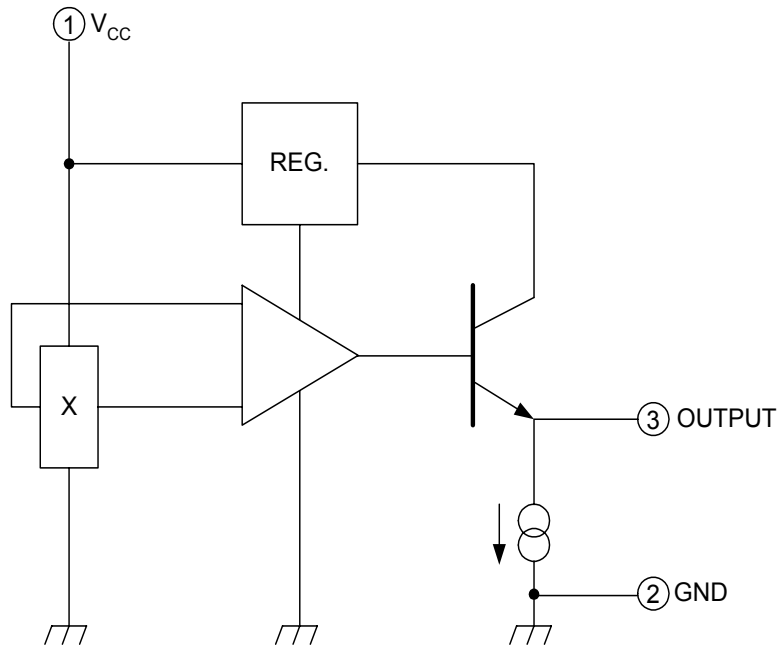
■ Block Diagram

■ Absolute Maximum Ratings

Parameter	Symbol	Rating	Unit
Supply voltage	Vcc	8	V
Magnetic flux density	B	Unlimited	Gauss
Operating temperature range	Top	-20~+85	°C
Storage temperature range	Tstg	-65~+150	°C

■ Electrical Characteristics (at Ta = 25°C, Vcc=5V)

Characteristic	Symbol	Conditions	Min	Typ	Max	Unit
Supply Voltage	Vcc		4.5	—	6.0	V
Supply Current	Icc		—	5	9	mA
Quiescent Output Voltage	Vout	B=0G	2.35	2.60	2.85	V
Sensitivity	ΔV_{out}	B=0G to $\pm 900G$	1.4	1.8	2.2	mV/G
Bandwidth (-3 dB)	BW		—	23	—	kHz
Broadband Output Noise	Vout	BW=10Hz to 10kHz	—	90	—	μV
Output Resistance	Rout		—	50	220	Ω

All output-voltage measurements are made with a voltmeter having an input impedance of at least 10 k Ω . Magnetic flux density is measured at most sensitive area of device located 1.15mm below from top side and 2.0mm from right side.

Linear Hall-Effect Sensors

■ Typical Performance Characteristics

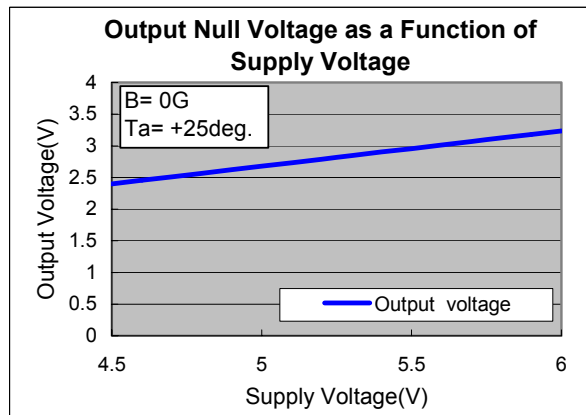
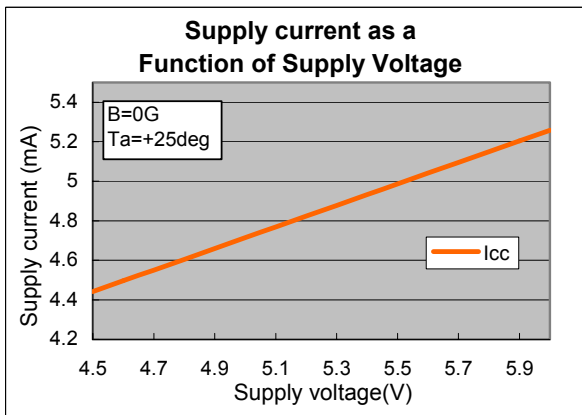
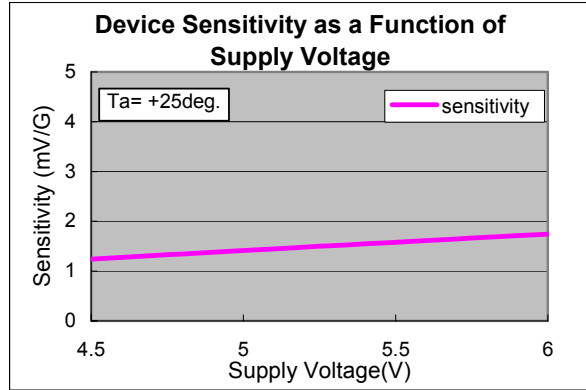
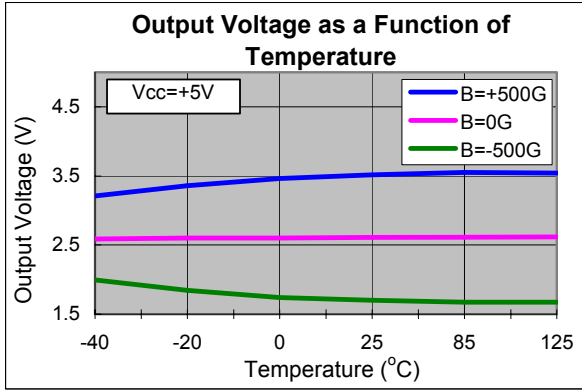

Linear Hall-Effect Sensors

■ Function Descriptions

The output null voltage ($B=0G$) is nominally one-half the supply voltage. A south magnetic pole, presented to the branded face of the Hall-effect sensor will drive the output higher than the null voltage level. A north magnetic pole will drive the output below the null level.

In operation, instantaneous and proportional output-voltage levels are dependent on magnetic flux density at the most sensitive area of the device. Greatest sensitivity is obtained with a supply voltage of 6V, but at the cost of increased supply current and a slight loss of output symmetry. The sensor's output is usually capacitively coupled to an amplifier that boosts the output above the millivolt level.

In two applications shown, a permanent bias magnet is attached with epoxy glue to the back of the epoxy package. The presence of ferrous material at the face of the package acts as a flux concentrator.

The south pole of a magnet is attached to the back of the package if the Hall-effect IC is to sense the presence of ferrous material. The north pole of a magnet is attached to the back surface if the integrated circuit is to sense the absence of ferrous material.

Calibrated linear Hall devices, which can be used to determine the actual flux density presented to the sensor in a particular application, are available.

■ Marking Information

(1) SIP3

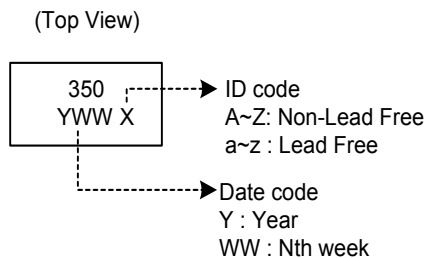

(2) SOT23

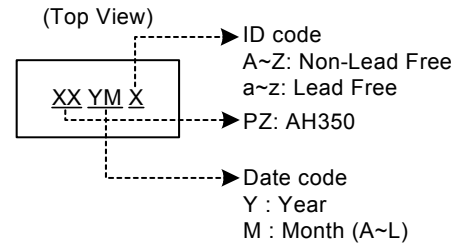

Linear Hall-Effect Sensors

■ Package Information

(1) SIP-3

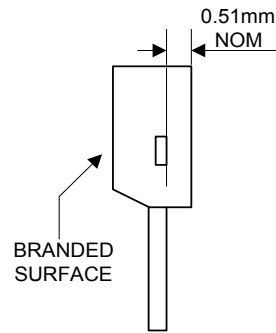

Active Area Depth

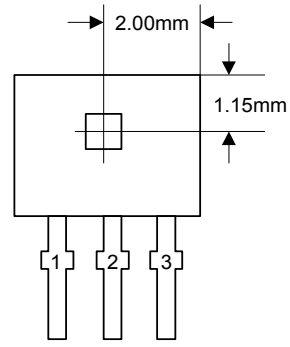

Sensor Location

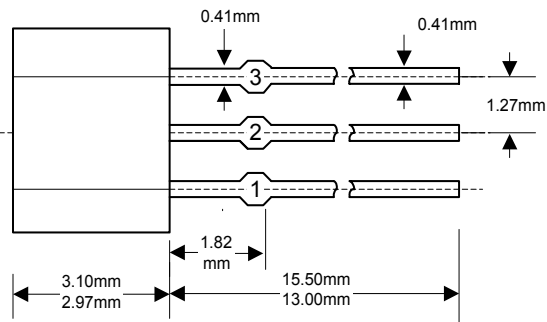
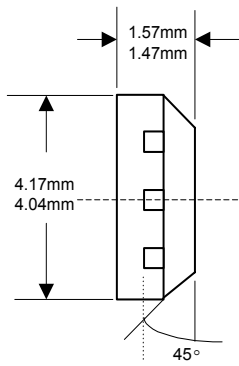
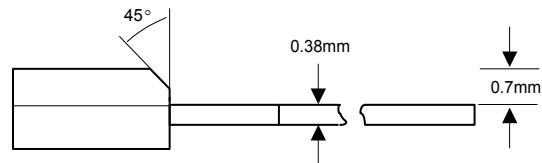

Package Dimension

Linear Hall-Effect Sensors

(2) SOT23-3L

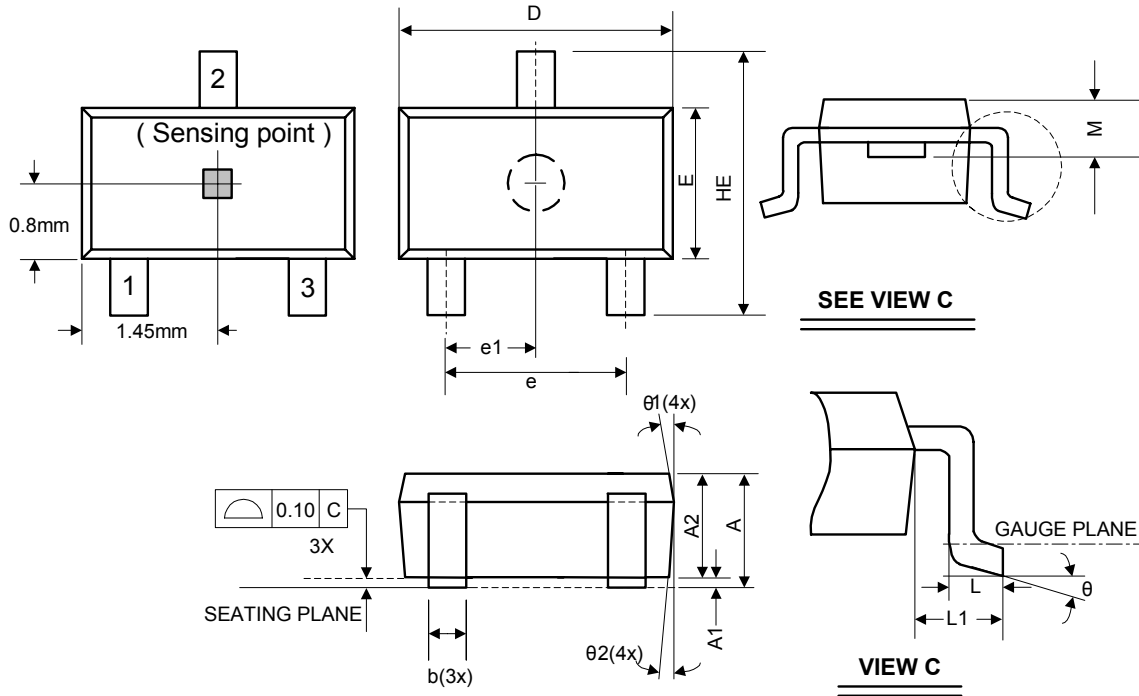

Symbol	Dimensions In Millimeters			Dimensions In Inches		
	Min.	Nom.	Max.	Min.	Nom.	Max.
A	1.05	-	1.35	0.041	-	0.053
A1	0.05	-	0.15	0.002	-	0.006
A2	1.00	1.10	1.20	0.039	0.043	0.047
b	0.25	-	0.50	0.010	-	0.020
C	0.08	-	0.20	0.003	-	0.008
D	2.70	2.90	3.00	0.106	0.114	0.118
E	1.50	1.60	1.70	0.059	0.063	0.067
HE	2.60	2.80	3.00	0.102	0.110	0.118
L	0.30	-	0.55	0.012	-	0.022
L1	0.50	0.60	0.70	0.020	0.024	0.028
M	0.73	0.78	0.83	0.029	0.031	0.033
e	1.80	1.90	2.00	0.071	0.075	0.079
e1	0.85	0.95	1.05	0.033	0.037	0.041
θ	0°	5°	10°	0°	5°	10°
θ_1	3°	5°	7°	3°	5°	7°
θ_2	6°	8°	10°	6°	8°	10°