

# AHT10 Technical Manual

# ASAIR®

## Temperature and humidity sensor

- Fully calibrated
- Digital output, I<sup>2</sup>C interface
- Excellent long-term stability
- SMD package reflow solderable
- Fast response and strong anti-interference ability



### Product overview

AHT10, the new generation of temperature and humidity sensors sets a new standard in size and intelligence: it is embedded for reflow soldering

The dual-row flat leadless SMD package has a 4x5mm bottom and a height of 1.6mm. The sensor outputs a calibrated digital signal in standard I2C format.

The AHT10 is equipped with a newly designed ASIC- specific chip, an improved MEMS semiconductor capacitive humidity sensing element and a standard on-chip temperature sensing element. Its performance has been greatly improved beyond the reliability level of the previous generation of sensors. The first generation of temperature and humidity sensors have been improved to make them more stable in harsh environments.

Each sensor is calibrated and tested with a product lot number printed on the surface of the product. Thanks to improved and miniaturized sensors, it is more cost-effective and ultimately all equipment will benefit from cutting-edge energy-saving operating modes.

## Application range

HVAC, dehumidifiers, testing and testing equipment, consumer goods, automobiles, automatic control, data logger, weather home appliances, humidity regulation, medical and other related temperature and humidity detection and control.

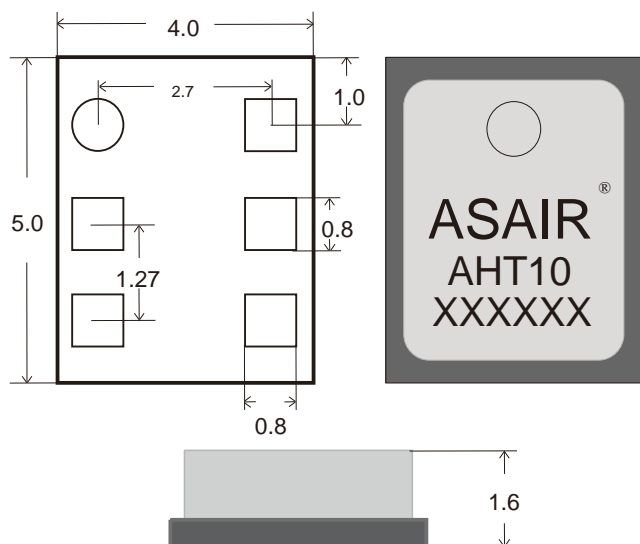
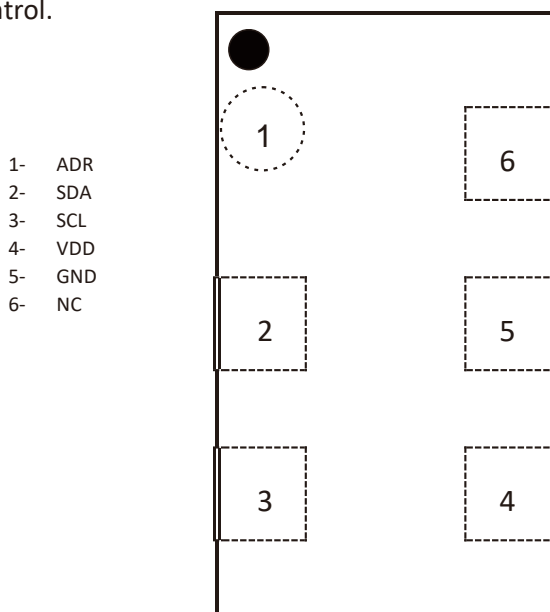

Figure 1: AHT10 sensor package diagram (unit: mm tolerance: 0.1mm)

# Sensor performance

## Relative humidity

parameter	condtn	min	typ	max	unit
Resolution	typical		0.024		%RH
Accuracy	typical		±2		%RH
	maximum	See Figure 2			%RH
Repeatability			±0.1		%RH
Hysteresis			±1		%RH
Nonlinear			<0.1		%RH
Response	t 63%		8		S
scope	extended	0		100	%RH
Drift	normal		<0.5		%RH/yr

table 1 humidity characteristics table  $\Delta$ RH(%RH)

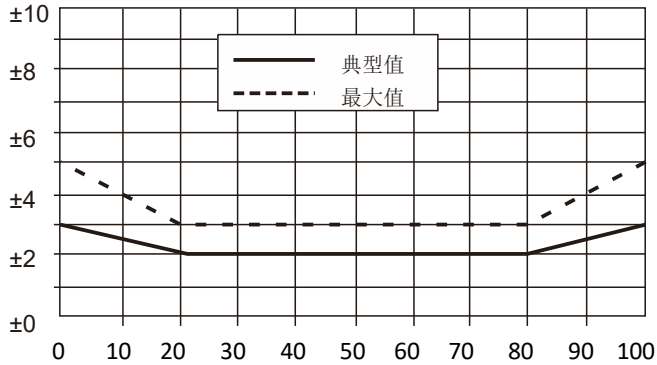

Figure 2 The maximum error of relative humidity at 25 °C

1. This accuracy is the test accuracy of the sensor at a factory voltage of 3.3V at 25 °C. This value does not include hysteresis and nonlinearity and only applies to Non-condensing conditions. <sup>2</sup>The time required to achieve a first-order response of 63% at 25 °C and 1 m / s airflow.
2. Normal operating range: 0-80% RH, beyond this range, sensor readings will be biased (drift <3% RH after 200 hours at 90% RH humidity). The scope of work is further limited to -40– 80 °C.
3. If there are volatile solvents, irritating tapes, adhesives, and packaging materials around the sensor, the readings may be high. Please refer to the relevant documents for detailed instructions.
4. The minimum and maximum values of supply current and power are based on VDD = 3.3V and T < 60 °C conditions. The average is the value measured once every two seconds.

## Temperature

parameter	condtn	min	typ	max	unit
Resolution	typical		0.01		°C
Accuracy	typical		±0.3		°C
	maximum	See Figure 3			°C
Repeatability			±0.1		°C
Hysteresis			±0.1		°C
Response	t 63%	5		30	S
scope	extended <sup>3</sup>	-40		85	°C
drift			<0.04		°C/yr

table 3 temperature characteristics table

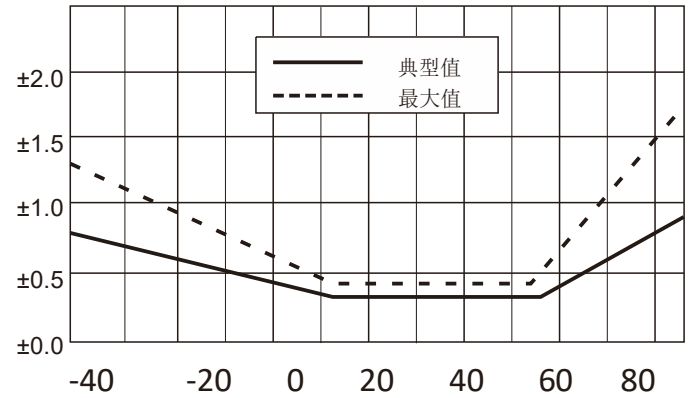

Figure 3 Typical temperature error and maximum error

5. The response time depends on the thermal conductivity of the sensor substrate.
6. Contact surface means The metal layer on the PCB where the SMD pads are soldered.
7. Solder mask The top layer of the PCB covers the insulating layer on the connecting line.
8. The type of solder is related to the size of the internal particles of the solder. Type 3 sizes range from 25 – 45 μm powder.
9. 75% RH can be easily saturated NaCl is generated.

## electrical characteristics

parameter	condition	min	typ	max	unit
Supply voltage	typical	1.8	3.3	3.6	V
Supply current,IDD	Sleep	-		0.25	μA
	measuring		23		μA
Power	Sleep	-		0.9	μW
	measuring		0.07		mW
	average	-	3.3	-	μW
communication	Two-wire digital interface , standard I <sup>2</sup> C protocol				

Table 2 Electrical characteristics

## packaging information

Sensor model	package	Quantity
AHT10	Tape and reel packaging	4000PCS/ volume

Table 4 package information.

# AHT10 User Guide

## 11 Expansion performance

### 1.1 Working conditions

The sensor has stable performance within the recommended operating range, see Figure 4 . Long-term exposure to conditions outside the normal range, especially at humidity >80 % , may result in temporary signal drift (drift after 60hours +3% RH ). When returning to normal operating conditions, the sensor will slowly self-recover to the calibration state. Refer to Section 2.3, “ Recovery Processing ” to speed up the recovery process. Prolonged use under abnormal conditions will accelerate the aging of the product.

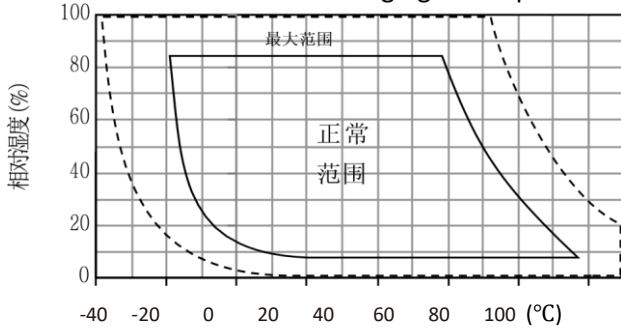

### 1.2 RH accuracy at different temperatures

The RH accuracy at 25 °C is defined in Figure 2 , and the maximum humidity error in other temperature segments is shown in Figure 5 .

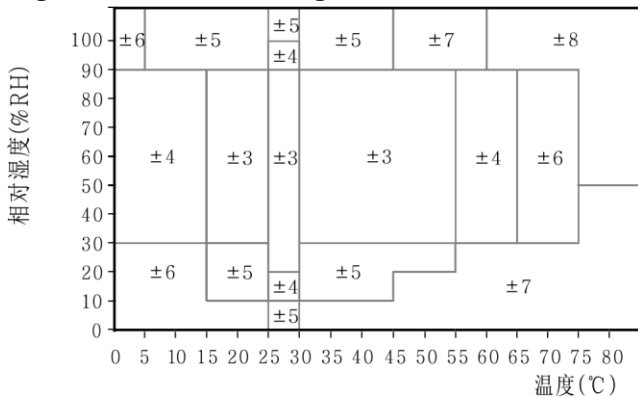

Figure The maximum humidity error in the range of 0 0~80 °C , unit : (%RH) Please note : The above error is the maximum error ( excluding hysteresis ) of the reference instrument test with high precision dew point meter . The maximum error of ± 3% RH typical range of error ± 2% RH, in other ranges, typically 1/2 of the maximum error value.

### 1.3 Electrical characteristics

The power consumption given in Table 1 is related to the temperature and supply voltage VDD . About power estimation and see Figure 6 7 . Please pay attention to the picture 6 and The curve in 7 is a typical natural characteristic and there may be deviations.

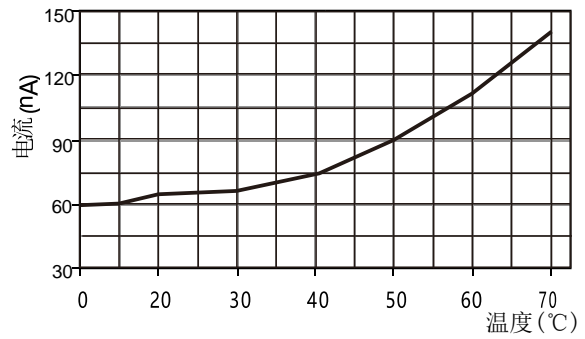

Figure 6 VDD = 3.3V , typical supply current vs. temperature (sleep mode).

Please note that these data and display values are approximately ±25% deviation.

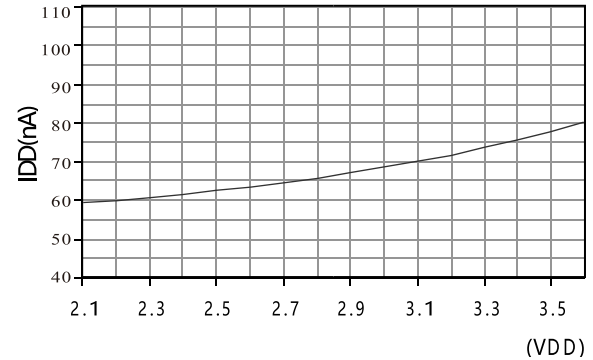

Figure 7 shows the relationship between typical supply current and supply voltage at a temperature of 25 °C . Curve (sleep mode). Please note that these data deviate from the displayed values. Can reach ±50% of the displayed value . At 60 ° C , the coefficient is about 15

(Compared with Table 2 ).

## 2 Application information

### 2.1 Welding instructions

SMD 's I/O pads are made of copper leadframe planar substrates, except that these pads are exposed to the outside for mechanical and electrical connections. When used, both the I/O pad and the exposed pad need to be soldered to the PCB . To prevent oxidation and optimize soldering, the solder joints on the bottom of the sensor are plated with Ni/Au.

On the PCB, I / O contact surface length should / O pads package is larger than the AHT10 I 0.2mm, to the portion on the inner side of the I / O pads to match the shape, and the width of the lead width ratio SMD pads of the package 1:1, see Figure 8 .

For stencil and solder mask design [7] It is recommended to use a copper foil definition pad ( SMD ) with a solder mask opening larger than the metal pad .

For the SMD pad, if the gap between the copper foil pad and the solder resist layer is  $60\ \mu\text{m} - 75\ \mu\text{m}$  , the solder mask opening size should be larger than the pad size  $120\ \mu\text{m} - 150\ \mu\text{m}$  . The rounded portion of the package pad is matched to the corresponding round solder mask opening to ensure that there is sufficient solder mask area (especially at the corners) to prevent solder from intersecting. Each pad must have its own solder mask opening to form a solder mask network around the adjacent pads.

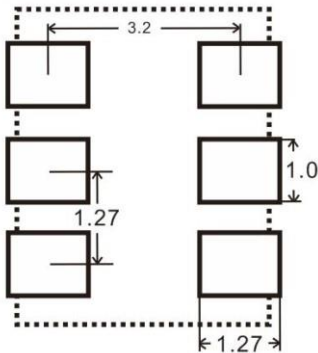

Figure 8 recommends the AHT10 PCB design dimensions (unit: mm), peripheral The dotted line is the outer dimensions of the SMD package.

For solder printing, it is recommended to use a laser-cut stainless-steel mesh with an electronically polished trapezoidal wall. The recommended mesh thickness is 0.125mm . The stencil size for the pad portion must be 0.1 mm longer than the PCB pad .

And placed at a distance of 0.1mm from the center of the package . The stencil of the exposed pad is covered

70%-90% of the pad area — that is,  $1.4\text{mm} \times 2.3\text{mm}$  at the center of the heat sink area . Due to the low placement height of SMD , it is recommended to use no-clean type 3 solder. and purify with nitrogen during reflow.

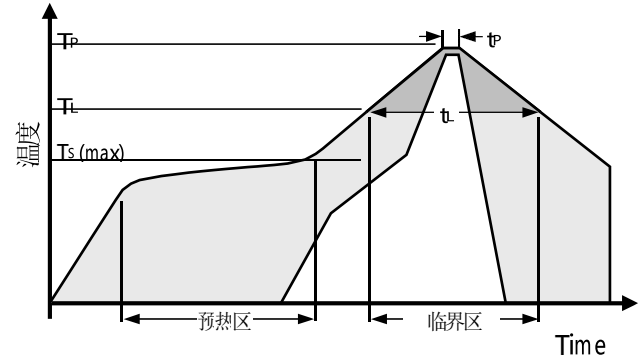

Figure 9 JEDEC standard welding process diagram,  $T_p \leq 260\ ^\circ\text{C}$  ,  $t_p < 30\ \text{sec}$  , lead-free soldering Pick up.  $T_l < 220\ ^\circ\text{C}$  ,  $t_l < 150\ \text{sec}$  , the rate of temperature rise and fall during welding Should be  $< 5\ ^\circ\text{C} / \text{sec}$  .

The AHT10 can be soldered using a standard reflow oven . The sensor is fully compliant with the IPC/JEDEC J-STD-020D soldering standard. The contact time should be less than 40 seconds at temperatures up to  $260\ ^\circ\text{C}$  ( see Figure 9 ) ; the ultimate soldering temperature that the sensor can withstand is  $260\ ^\circ\text{C}$  .

Note: After reflow soldering, the sensor should be stored in a  $>75\% \text{ RH}$  environment for at least 12 hours to ensure rehydration of the polymer. Failure to do so will cause the sensor reading to drift. It is also possible to place the sensor in a natural environment (  $>40\% \text{ RH}$  ) for more than 5 days to rehydrate it. Use low temperature reflow soldering

(Example :  $180\ ^\circ\text{C}$  ) can reduce hydration time.

Do not flush the board after soldering. Therefore, customers are advised to use " no-clean " solder paste. If the sensor is used in corrosive gases or if condensed water is produced (eg, in a high-humidity environment), both the lead pad and the PCB need to be sealed (eg, using a conformal coating) to avoid poor contact or short circuit.

## 2.2 Storage conditions and operating instructions

Humidity sensitivity level (MSL) is 1, based on

IPC/JEDEC J-STD-020 standard. Therefore, it is recommended to use it within one year after shipment.

Humidity sensors are not ordinary electronic components and require careful protection. This must be taken seriously by users. Prolonged exposure to high concentrations of chemical vapor will cause the sensor reading to drift. It is recommended to store the sensors ESD original package comprises a sealed bag, and meet the following conditions:



Sensors should be avoided during production and transportation

High concentrations of chemical solvents and prolonged exposure.

Avoid contact with volatile glue, tape, stickers or volatile packaging materials. Such as foam, foam and so on. The production area should be well ventilated.

## 2.3 recovery processing

As described above, if the sensor is exposed to extreme conditions or chemical vapors, readings generated drift. It can be restored to the calibration state by the following processing.

Drying: maintained at 80-85 ° C and <5% RH humidity for 10 hours;

Rehydration: 12 hours at 20-30 ° C and >75% RH humidity.

## 2.4 temperature effects

The relative humidity of a gas depends to a large extent on temperature. Therefore, when measuring humidity, it should be ensured that all sensors measuring the same humidity work at the same temperature. When testing, ensure that the sensor under test and the reference sensor are at the same temperature and then compare the humidity readings.

If the sensor is on the same printed circuit board as the heat-generating electronic components, measures should be taken to minimize the effects of heat transfer when designing the circuit.

Temperature range 10 ° C -50 ° C (0-85 deg.] C for a limited time); humidity of 20-60% RH (no ESD Package Sensor). For sensors that have been removed from the original packaging, we recommend storing them in the inner metal.

Anti-static bag made of PET/AL/CPE material.

---

In addition, when the measurement frequency is too high, the sensor's own temperature will rise and affect the measurement accuracy. If it is to ensure that its own temperature rise is less than 0.1 ° C, the activation time of AHT10 should not exceed the measurement time. 10% - recommended every 2 seconds measurement data once.

## 2.5 Materials for sealing and packaging

Many materials absorb moisture and act as a buffer, which increases response time and hysteresis. Therefore, the material around the sensor should be carefully selected. The recommended materials are: metal, LCP, POM (Delrin), PTFE (Teflon), PE, PEEK, PP, PB, PPS, PSU, PVDF, PVF.

For sealing and gluing (the conservative recommendation): recommended package, or an electronic component using a silicone resin-filled epoxy. The gases released by these materials may also contaminate AHT10 (see 2.2). Therefore, the sensor should be assembled last and placed in a well-ventilated area or dried in an environment > 50 ° C for 24 hours to allow the release of contaminated gases prior to packaging.

## 2.6 wiring rules and signal integrity

If the SCL and SDA signal lines are parallel and very close to each other, it may cause signal crosstalk and communication failure. The solution is to place VDD and / or GND between

For example, to maintain good ventilation of the outer casing, the copper plating of the AHT10 and other parts of the printed circuit board should be as small as possible, or a gap should be left between the two. (See Figure 10 ).

the two signal lines, separate the signal lines, and use shielded cables. In addition, lower The SCL frequency may also improve the integrity of the signal transmission. A100nF decoupling capacitor must be added between the power supply pins (VDD , GND )for filtering. This capacitor should be as close as possible to the sensor. See the next chapter.

### 3 Interface definition

Pin	name	Interpretation
1	ADR	Power ground
2	SDA	Serial data
3	SCL	Serial clock
4	VDD	Supply voltage
5	GND	Power ground
6	NC	Stay vacant

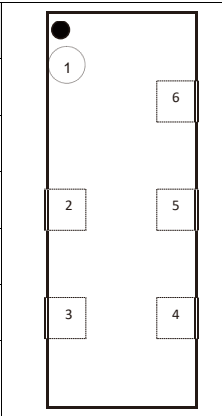

Table 5 AHT10 pin distribution (top view).

#### 3.1 Power supply pin (VDD, GND)

AHT10 power supply range of 1.8-3.6V, recommended voltage is 3.3V. A 100nF decoupling capacitor must be connected between the power supply ( VDD ) and ground ( GND ) and the capacitor should be placed as close as possible to the sensor - see Figure 11 .

#### 3.2 Serial clock SCL

SCL is used for communication synchronization between the microprocessor and the AHT10 . Since the interface contains completely static logic, there is no minimum SCL frequency.

#### 3.3 serial data SDA

The SDA pin is used for data input and output of the sensor. SDA is active on the rising edge of the serial clock ( SCL ) when a command is sent to the sensor , and SDA must remain stable when SCL is high . After the falling edge of SCL , the SDA value can be changed. To ensure communication security, the effective time of the SDA should be extended to TSU and THO before and after the rising edge of SCL - see Figure 12 . When reading data from the sensor, SDA is low after SCL active (TV), and maintained until the falling edge of SCL.

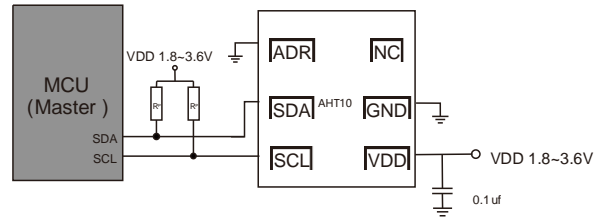

Figure 11 shows a typical application circuit that includes a pull-up resistor RP and a decoupling capacitor between VDD and GND.

Note : 1. The power supply voltage of the host MCU must be consistent with the sensor when the product is in use .

2, To further improve the reliability of the system, the sensor power can be controlled.

3, Only a single AHT10 can be connected to the I2C bus and no other I2C devices can be connected .

To avoid signal collisions, the microprocessor ( MCU ) must only drive SDA and SCL low. An external pull-up resistor (eg 10k  $\Omega$  ) is required to pull the signal high. Pull-up resistors are usually already included in the microprocessor In the I/O circuit. Reference table 7 and table 8 can get detailed information about sensor input / output characteristics.

### 4 Electrical characteristics

#### 4.1 Absolute maximum rating

The electrical characteristics of AHT10 are defined in Table 1 . The absolute maximum ratings given in Table 6 are stress ratings only and provide more information. Under such conditions, it is not advisable for the device to perform functional operations. Prolonged exposure to absolute maximum ratings may affect sensor reliability.

parameter	Minimum	maximum	unit
VDD to GND	-0.3	3.6	V
Digital I/O pin(SDA, SCL) toGND	-0.3	VDD +0.3	V
Input current per pin	-10	10	mA

Table 6 Electrical Absolute Maximum Ratings

ESD electrostatic discharge meets JEDEC JESD22-A114 standard ( Human Body Mode  $\pm 4kV$ ), JEDEC JESD22-A115。 ( machine mode  $\pm 200V$ ) . If the test conditions exceed the nominal limit , the sensor requires an additional protection circuit.



## 4.2 Input / output characteristics

Electrical characteristics, such as power consumption, high and low voltages of the input and output, etc., depend on the power supply voltage. In order to make the sensor communication smooth, it is important to ensure that the signal design is strictly limited to the ranges given in Tables 7, 8, and 12.

parameter	condition	Minimum	typical	maximum	unit
Output low voltage VOL	VDD = 3.3V, -4mA < IOL < 0mA	0	-	0.4	V
Output high voltage VOH		70% VDD	-	VDD	V
Output sink current IOL		-	-	-4	mA
Input low voltage VIL		0	-	30% VDD	V
Input high voltage VIH		70% VDD	-	VDD	V
Input Current	VDD = 3.6 V, VIN=0V to 3.6V	-	-	±1	uA

Table 7 DC characteristics of the digital input and output pads, if there is no special statement, VDD = 1.8 V to 3.6 V, T = -40 ° C to 85 ° C.

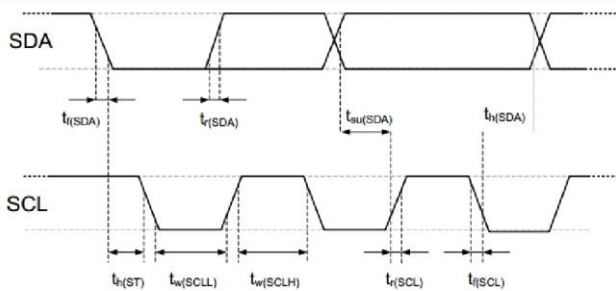

Figure 12 shows the timing diagram and abbreviations of the digital input / output terminals in Table 8.

Explanation. The thicker SDA line is controlled by the sensor, the normal SDA line is controlled by a single chip microcomputer. Please note that the effective read time of SDA is from the previous one. Triggered by the falling edge of the conversion.

parameter	Label	I <sup>2</sup> C typical mode		I <sup>2</sup> C high speed mode		unit
		MIN	MAX	MIN	MAX	
I <sup>2</sup> C clock frequency	fSCL	0	100	0	400	KHz
Start signal time	tHDSTA					μs
SCL clock high level width	tHIGH	4.7		1.3		μs
SCL clock low level width	tLOW	4.0		0.6		μs
Data retention time relative to the SCL SDA edge	tHDDAT	0.09	3.45	0.02	0.9	μs
Data setup time relative to the SCL SDA edge	tSUDAT	250		100		μs

Note : Measurements for both pins are from 0.2VDD and 0.8VDD.  
 Note : The above I<sup>2</sup>C timing is determined by the following internal delay:  
 (1) The internal SDI input pin is delayed relative to the SCK pin, typically 100ns  
 (2) The internal SDI output pin is delayed relative to the SCK falling edge, typically 200ns

Table 8 Timing characteristics of the I<sup>2</sup>C fast mode digital input / output. The specific meaning is shown in Figure 12. Unless otherwise stated.

## 5 Sensor communication

The AHT10 communicates using the standard I<sup>2</sup>C protocol. For information on the I<sup>2</sup>C protocol other than the following sections, please refer to the following website : [www.aosong.com](http://www.aosong.com) provides a sample program reference.

### 5.1 Start sensor

The first step is to power up the sensor and the voltage is selected. VDD supply voltage (range between 1.8V and 3.6V). After power-on, the sensor needs at most 20 milliseconds time SCL is high) to reach the idle state, ready to receive commands sent by the host (MCU).

### 5.2 Start / stop timing

Each transmission sequence is The Start state is started and ends with the Stop state, as shown in the figure. 13 and map 14

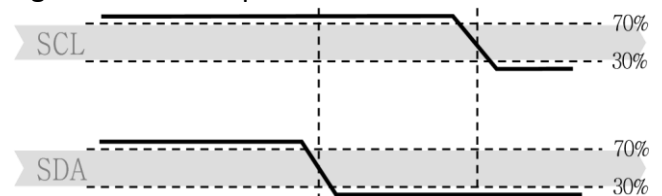



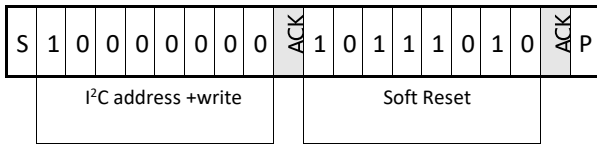

Figure 17 soft reset – the gray part consists of AHT10 control.

## 6 Signal conversion

### 6.1 Relative humidity conversion

Relative humidity RH Can be based on SDA Output relative humidity signal S<sub>RH</sub> Calculated by the following formula (the result is %RH indicates).

$$RH[\%]=\left(\frac{S_{RH}}{2^{20}}\right)*100\%$$

### 6.2 Temperature conversion

Temperature T Can output the signal by the temperature S<sub>T</sub> Substitute into the formula below to calculate (Results are expressed in temperature °C):

$$T(^{\circ}C)=\left(\frac{S_T}{2^{20}}\right)*200-50$$

## 7 Environmental stability

If the sensor is used in equipment or machinery, make sure that the sensor used for the measurement and the sensor used for the reference perceive the same conditions of temperature and humidity. If the sensor is placed in the equipment, the reaction time will be extended, so it is necessary to ensure sufficient measurement time in the programming. The AHT10 sensor is tested according to the AOSONG temperature sensor. The performance of the sensor under other test conditions is not guaranteed and cannot be used as part of the sensor's performance. In particular, no commitment is made to the specific circumstances requested by the user.

8 package

The AHT10 is available in an SMD package (similar to QFN), and the SMD is a two-sided, leadless flat package. The sensor chip is made of Ni/

Made of Au 's copper lead frame. The sensor weighs about 63mg.

### 8.1 tracking information

All AHT10 sensor surfaces are laser marked. See picture 18



Figure 18 sensor laser identification.

Labels are also placed on the reels, as shown in Figure 19 , and other tracking information is provided. .



图19：卷轴上的标签。

### 8.2 Transport Packaging

The AHT10 is packaged in tape and reel and sealed in an antistatic ESD bag. The standard package size is 4000 pieces per roll. For the AHT10 package, the 440mm (55 sensor capacity) and front 200mm (25 sensor capacity) portions of each reel are empty.

The package diagram with sensor positioning is shown in Figure 20. The reel is placed in an anti-static pocket.

Model	A	E	W1	W2	N	Unit	Tolerance	Quantity	Weight
AHT10	330	2	12	16	100	mm	±0.5	4000	500/g

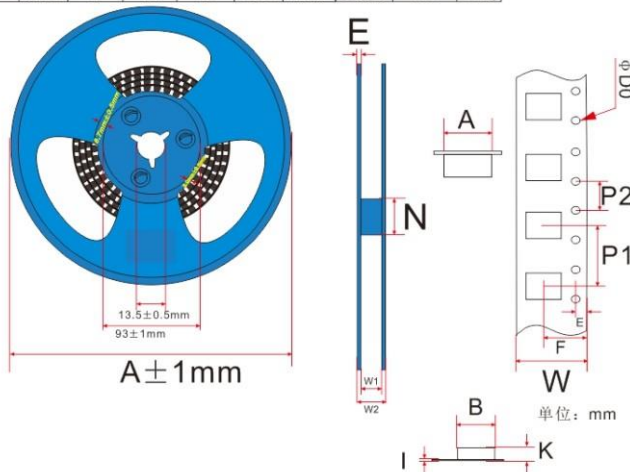

Model	A	B	φD0	K	W	P1	P2	I	F	E
AHT10	4.5±0.1	5.8±0.1	1.5±0.1	2.2±0.1	12.0±0.1	8.0±0.1	4.0±0.1	0.25±0.05	7.0±0.1	1.75±0.1

Figure 20 packaging tape and sensor positioning map

## Version Information

date	version	page number	change
2018/11	V1.0	1-10	Initial version
2018/12	V1.1	1-10	Added protocol description, command parameters.
2019/05	V1.1	1-13	Draft <b>UNOFICIAL</b> English translation

This manual is subject to change without notice.

### Precautions

#### Warning, personal injury

Do not apply this product to safety devices or emergency stop devices, and to any other application that may result in personal injury due to malfunction of the product. This product may not be used unless it has a special purpose or authorization to use it. Refer to the product data sheet and application guide before installing, handling, using, or maintaining this product. Failure to follow this advice can result in death and serious personal injury.

If the buyer is to purchase or use AOSONG products without any application license and authorization, the buyer will bear all compensation for personal injury and death, and will be exempt from the AOSONG company managers and employees and affiliated subsidiaries. Any claims that may arise from agents, distributors, etc., including: various costs, compensation, legal fees, etc.

### ESD protection

Due to the inherent design of the component, it is sensitive to static electricity. To prevent damage from static electricity or to reduce product performance, take the necessary antistatic measures when applying this product.

### Quality Assurance

The company provides a 12 -month (one- year) warranty on the direct purchaser of its products (calculated from the date of shipment), based on the technical specifications in the data sheet of the product published by AOSONG. If the product proves to be defective during the warranty period, the company will provide free repair or replacement. The user must meet the following conditions:

The product is found defective within 14 days written notice to the Company; ● This product defect helps to discover the company's design and materials ● Insufficient materials and processes;

This product should be returned to the company by the purchaser; ● This product should be in the warranty period. ●

The company is only responsible for products that are defective in applications that meet the technical requirements of the product. The company does not make any guarantees, guarantees or written statements about the application of its products in those special applications.

At the same time, the company does not make any commitment to the reliability of its products applied to products or circuits.

Copyright © 2018, ASAIR ®