

FEATURES

- Low Dropout Voltage of 130mV at 100mA Output Current (5V Output Version).
- Guaranteed 150mA/300mA Output Current.
- Internal 1.3Ω P-MOSFET Draws no Base Current.
- Low Ground Current at 55μA.
- 1% Accuracy Output Voltage of 3.3V/5V.
- Input Voltage Range up to 12V (5V Output Version).
- Extremely Tight Load and Line Regulation.
- Fast Transient Response.
- Needs only 1μF for Stability.
- Current and Thermal Limiting.

APPLICATIONS

- Voltage Regulator for LAN Cards.
- Wireless Communication Systems.
- Battery Powered Systems.

DESCRIPTION

The AIC1721/1721D is the enhanced CMOS version of the LP2950. The superior characteristics of the AIC1721/1721D include zero base current loss, very low dropout voltage, and 1% accuracy output voltage. Typical ground current remains approximately 55μA, from no load to maximum loading conditions. Dropout voltage at 100mA output current is significantly lower than its bipolar counterpart: 130mV for the AIC1721-5/1721D-5, and 180mV for the AIC1721/ 1721D. Output current limiting and thermal limiting are built in to provide maximal protection to the AIC1721/ 1721D against fault conditions.

While pin-to-pin compatible with the LP2950 and the industry industry standard 78XX series of voltage regulators, the AIC1721/1721D comes in the popular 3-pin SOT-89 or TO-92 packages.

TYPICAL APPLICATION CIRCUIT

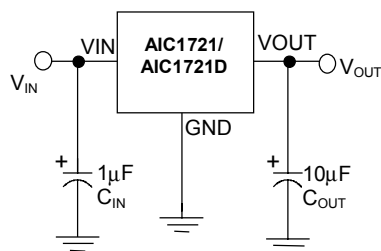

Negative Voltage Regulator

ORDERING INFORMATION

AIC1721X-XXX

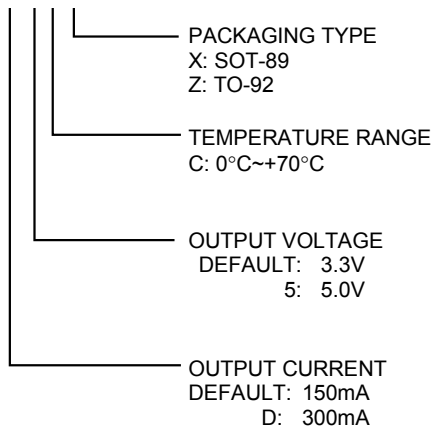

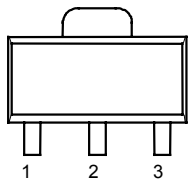
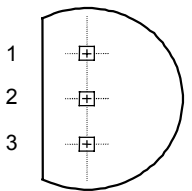
ORDER NUMBER	PIN CONFIGURATION
AIC1721CX AIC1721-5CX AIC1721DCX AIC1721D-5CX (SOT-89)	FRONT VIEW 1: VOUT 2: GND 3: VIN 
AIC1721CZ AIC1721-5CZ AIC1721DCZ AIC1721D-5CZ (TO-92)	TOP VIEW 1: VOUT 2: GND 3: VIN 

ABSOLUTE MAXIMUM RATINGS

Input Supply Voltage	-0.3~12V
Operating Junction Temperature Range	-40°C~ 125°C
Storage Temperature Range	-65°C~150°C
Power Dissipation	SOT-89 Package 0.80W
	TO-92 Package 0.78W

TEST CIRCUIT

Refer to the TYPICAL APPLICATION CIRCUIT

■ **ELECTRICAL CHARACTERISTICS** ($T_a=25^{\circ}\text{C}$, $C_{IN}=1\mu\text{F}$, $C_{OUT}=10\mu\text{F}$, unless otherwise specified.)

PARAMETER	TEST CONDITIONS	MIN.	TYP.	MAX.	UNIT
Output Voltage	No Load				V
	AIC1721/1721D-5 $V_{IN}=5.5\sim 12\text{V}$	4.950	5.0	5.050	
	AIC1721/1721D $V_{IN}=3.6\sim 12\text{V}$	3.267	3.3	3.333	
Output Voltage Temperature Coefficiency	(Note 1)		50	150	PPM/ $^{\circ}\text{C}$
Line Regulation	$I_L=1\text{mA}$				mV
	AIC1721/1721D-5 $V_{IN}=5.5\sim 12\text{V}$		3	10	
	AIC1721/1721D $V_{IN}=3.6\sim 12\text{V}$		3	10	
Load Regulation (Note 2)	AIC1721-5 $V_{IN}=7\text{V}$, $I_L=0.1\sim 150\text{mA}$		7	15	mV
	AIC1721D-5 $V_{IN}=7\text{V}$, $I_L=0.1\sim 300\text{mA}$		7	25	
	AIC1721 $V_{IN}=5\text{V}$, $I_L=0.1\sim 150\text{mA}$		7	15	
	AIC1721D $V_{IN}=5\text{V}$, $I_L=0.1\sim 300\text{mA}$		7	25	
Current Limit (Note 3)	AIC1721-5 $V_{IN}=7\text{V}$, $V_{OUT}=0\text{V}$	320	440		mA
	AIC1721 $V_{IN}=5\text{V}$, $V_{OUT}=0\text{V}$	320	440		
	AIC1721D-5 $V_{IN}=7\text{V}$, $V_{OUT}=0\text{V}$	320	440		
	AIC1721D $V_{IN}=5\text{V}$, $V_{OUT}=0\text{V}$	320	440		
Dropout Voltage (Note 4)	AIC1721/1721D $I_L=0.1\text{mA}$		0.2	10	mV
	AIC1721-5 $I_L=150\text{mA}$		200	300	
	AIC1721 $I_L=150\text{mA}$		270	370	
	AIC1721D-5 $I_L=300\text{mA}$		400	500	
	AIC1721D $I_L=300\text{mA}$		540	640	
Ground Current	$I_O=0.1\text{mA}\sim I_{MAX}$				μA
	AIC1721/1721D-5 $V_{IN}=5.5\sim 12\text{V}$		55	80	
	AIC1721/1721D $V_{IN}=4\sim 12\text{V}$		55	80	

Note 1: Guaranteed by design.

Note 2: Regulation is measured at constant junction temperature, using pulse testing with a low ON time.

Note 3: Current limit is measured by pulsing a short time.

Note 4: Dropout voltage is defined as the input to output differential at which the output voltage drops 100mV below the value measured with a 1V differential.

■ BLOCK DIAGRAM

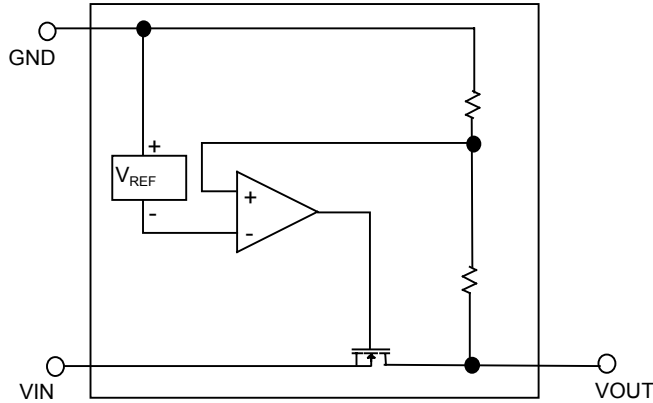

■ TYPICAL PERFORMANCE CHARACTERISTICS

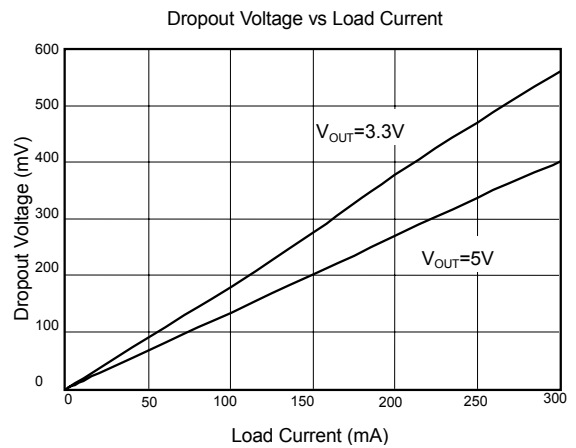
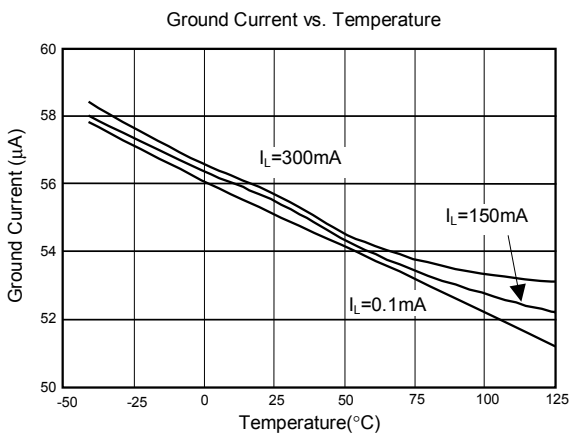
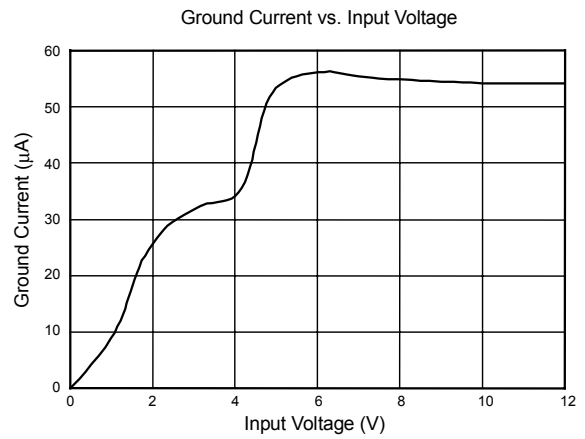
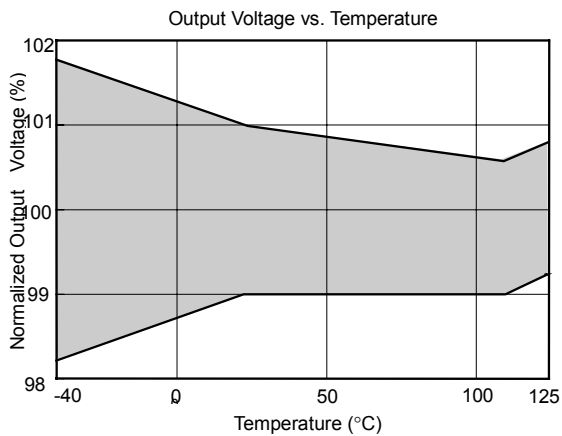

TYPICAL PERFORMANCE CHARACTERISTICS (Continued)

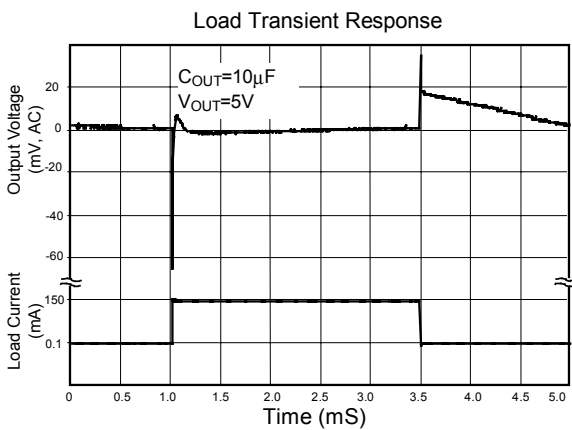
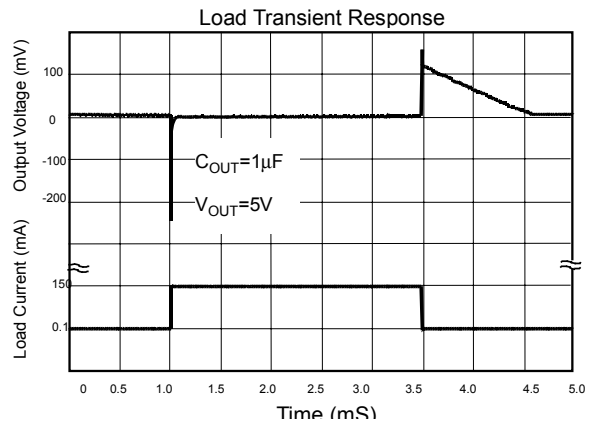
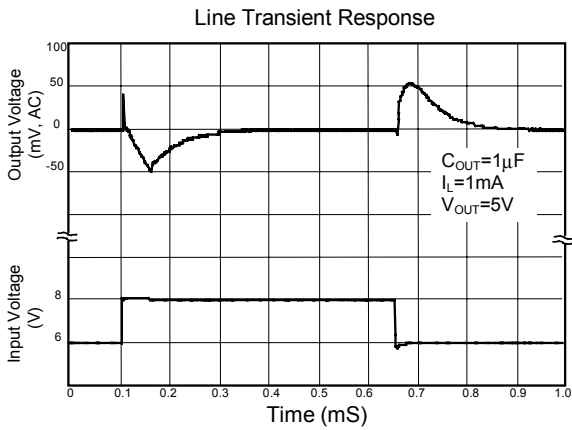
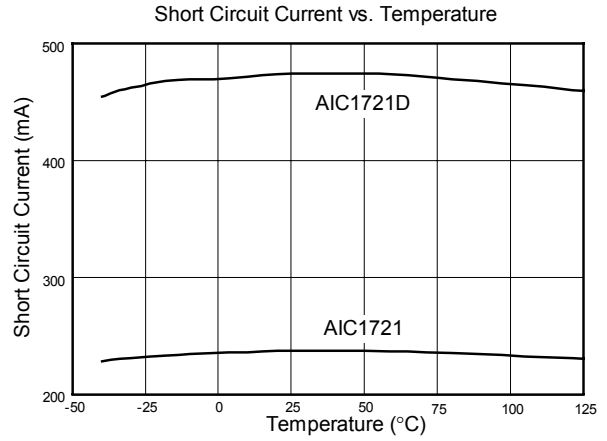
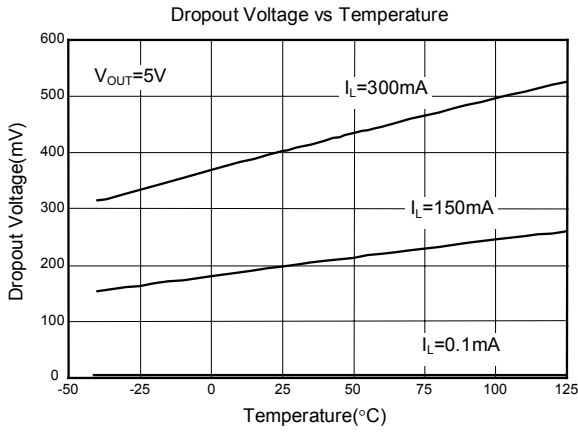

■ PHYSICAL DIMENSIONS

- SOT-89 (unit: mm)

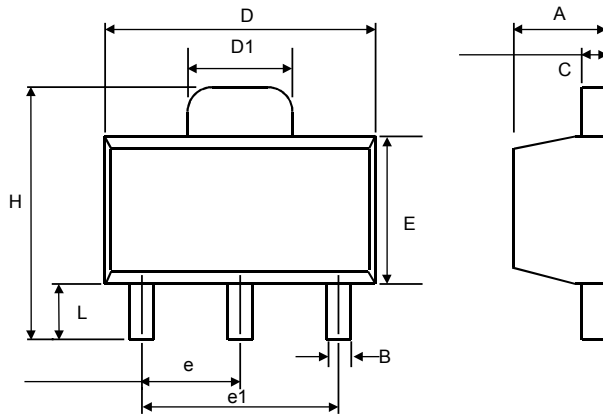

SYMBOL	MIN	MAX
A	1.40	1.60
B	0.36	0.48
C	0.35	0.44
D	4.40	4.60
D1	1.62	1.83
E	2.29	2.60
e	1.50 (TYP.)	
e1	3.00 (TYP.)	
H	3.94	4.25
L	0.89	1.20

- SOT89 Marking

Part No.	Marking
AIC1714-30	AP30
AIC1714-33	AP33
AIC1714-50	AP50

- TO-92 (unit: mm)

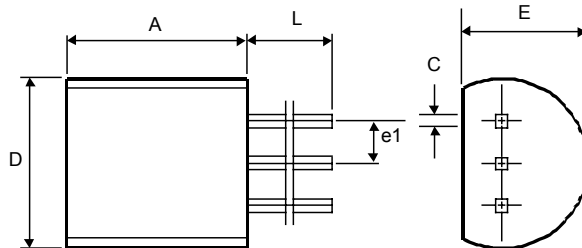

SYMBOL	MIN	MAX
A	4.32	5.33
C	0.38 (TYP.)	
D	4.40	5.20
E	3.17	4.20
e1	1.27 (TYP.)	
L	12.7	-