

Final datasheet

CoolSiC™ 1200 V SiC Trench MOSFET : Silicon Carbide MOSFET

Features

- $V_{DS} = 1200\text{ V}$ at $T_{vj} = -55...175^\circ\text{C}$
- $I_{DC} = 22\text{ A}$ at $T_C = 25^\circ\text{C}$
- $R_{DS(on)} = 117\text{ m}\Omega$ at $V_{GS} = 20\text{ V}$, $T_{vj} = 25^\circ\text{C}$
- New performance-optimized chip technology (Gen1p) with improved $R_{DS(on)}^* \text{ A}$
- Best in class switching energy for lower switching losses and reduced cooling efforts
- Lowest device capacitances for higher switching speeds and higher power density
- A combination of low C_{rSS}/C_{iSS} ratio and high $V_{GS(th)}$ to avoid parasitic turn-on and enable unipolar gate driving
- Reduced total gate charge Q_G for lower driving power and losses
- Increased recommended turn-on voltage ($V_{GS(on)} = 20\text{ V}$) for lower $R_{DS(on)}$
- .XT die attach technology for best in class thermal performance
- Low package stray inductance for faster and cleaner switching
- Sense (Kelvin) source pin for better gate control and reduced switching losses
- Minimal creepage distance 5.85 mm (material group II) to fit 800 V applications without coating
- SMT package for automated assembly and reduced system costs

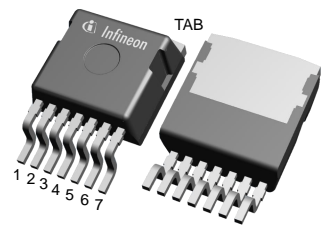

Potential applications

- On-board charger
- DC/DC converter
- Auxiliary drives

Product validation

- Qualified for Automotive Applications. Product Validation according to AEC-Q100/101

Description

Pin definition:

- Pin 1 - Gate
- Pin 2 - Kelvin sense contact
- Pin 3...7 - Source
- Tab - Drain

Note: The source and sense pins are not exchangeable, their exchange might lead to malfunction

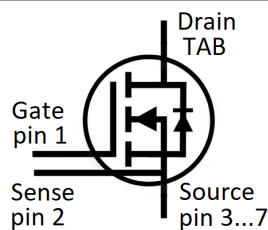

Type	Package	Marking
AIMBG120R120M1	PG-TO263-7-HV-ND5.8	AS120MM1

Table of contents

	Description	1
	Features	1
	Potential applications	1
	Product validation	1
	Table of contents	2
1	Package	3
2	MOSFET	3
3	Body diode (MOSFET)	5
4	Characteristics diagrams	7
5	Package outlines	13
6	Testing conditions	14
	Revision history	15
	Disclaimer	16

1 Package

1 Package

Table 1 Characteristic values

Parameter	Symbol	Note or test condition	Values			Unit
			Min.	Typ.	Max.	
Storage temperature	T_{stg}		-55		150	°C
Soldering temperature	T_{sold}				260	°C
MOSFET/body diode thermal resistance, junction-case ¹⁾	$R_{th(j-c)}$			0.88	1.15	K/W

1) not subject to production test - verified by design/characterization

2 MOSFET

Table 2 Maximum rated values

Parameter	Symbol	Note or test condition	Values	Unit	
Drain-source voltage ¹⁾	V_{DSS}	$T_{vj} = -55...175\text{ °C}$	1200	V	
Continuous DC drain current for $R_{th(j-c,max)}$, limited by $T_{vj(max)}$ ²⁾	I_{DDC}	$V_{GS} = 20\text{ V}$	$T_c = 25\text{ °C}$	22	A
			$T_c = 100\text{ °C}$	16	
Peak drain current, t_p limited by $T_{vj(max)}$ ²⁾	I_{DM}	$V_{GS} = 20\text{ V}$	54	A	
Gate-source voltage, max. transient voltage ³⁾	V_{GS}	$t_p \leq 0.5\ \mu\text{s}, D < 0.01$	-10...25	V	
Gate-source voltage, max. static voltage ³⁾	V_{GS}		-5...23	V	
Avalanche energy, single pulse	E_{AS}	$I_D = 5.1\text{ A}, V_{DD} = 50\text{ V}, L = 7.02\text{ mH}$	92	mJ	
Power dissipation, limited by $T_{vj(max)}$ ²⁾	P_{tot}		$T_c = 25\text{ °C}$	130	W
			$T_c = 100\text{ °C}$	65	

1) Tested at $T_{vj}=25\text{ °C}$, verified by design/characterization over full temperature range

2) not subject to production test - verified by design/characterization

3) **Important note:** The selection of positive and negative gate-source voltages impacts the long-term behavior of the device. The design guidelines described in Application Note AN2018-09 must be considered to ensure sound operation of the device over the planned lifetime.

Table 3 Recommended values

Parameter	Symbol	Note or test condition	Values	Unit
Recommended turn-on gate voltage	$V_{GS(on)}$		20	V
Recommended turn-off gate voltage	$V_{GS(off)}$		0	V

Table 4 Characteristic values

Parameter	Symbol	Note or test condition	Values			Unit	
			Min.	Typ.	Max.		
Drain-source on-state resistance	$R_{DS(on)}$	$I_D = 7\text{ A}$	$T_{vj} = 25\text{ °C}$, $V_{GS(on)} = 20\text{ V}$		117	150	mΩ
			$T_{vj} = 100\text{ °C}$, $V_{GS(on)} = 20\text{ V}$		164		
			$T_{vj} = 175\text{ °C}$, $V_{GS(on)} = 20\text{ V}$		234		
			$T_{vj} = 25\text{ °C}$, $V_{GS(on)} = 18\text{ V}$		126		
Gate-source threshold voltage	$V_{GS(th)}$	$I_D = 2.2\text{ mA}$, $V_{DS} = V_{GS}$ (tested after 1 ms pulse at $V_{GS} = 20\text{ V}$)	$T_{vj} = 25\text{ °C}$	3.7	4.4	5.1	V
			$T_{vj} = 175\text{ °C}$		3.6		
Zero gate-voltage drain current	I_{DSS}	$V_{DS} = 1200\text{ V}$, $V_{GS} = 0\text{ V}$	$T_{vj} = 25\text{ °C}$		0.1	6	μA
			$T_{vj} = 175\text{ °C}$		10		
Gate leakage current	I_{GSS}	$V_{DS} = 0\text{ V}$	$V_{GS} = 25\text{ V}$			100	nA
			$V_{GS} = -10\text{ V}$			-100	
Forward transconductance	g_{fs}	$I_D = 7\text{ A}$, $V_{DS} = 20\text{ V}$		4.2			S
Short-circuit withstand time ¹⁾	t_{SC}	$V_{DD} \leq 800\text{ V}$, $V_{DS,peak} < 1200\text{ V}$, $T_{vj(start)} = 25\text{ °C}$, $R_{G,ext} = 2\text{ }\Omega$	$V_{GS(on)} = 20\text{ V}$		1.5		μs
			$V_{GS(on)} = 18\text{ V}$		2		
			$V_{GS(on)} = 15\text{ V}$		2.5		
Internal gate resistance	$R_{G,int}$	$f = 1\text{ MHz}$, $V_{AC} = 25\text{ mV}$		3.6			Ω
Input capacitance	C_{iss}	$V_{DD} = 800\text{ V}$, $V_{GS} = 0\text{ V}$, $f = 100\text{ kHz}$, $V_{AC} = 25\text{ mV}$		458			pF
Output capacitance	C_{oss}	$V_{DD} = 800\text{ V}$, $V_{GS} = 0\text{ V}$, $f = 100\text{ kHz}$, $V_{AC} = 25\text{ mV}$		25			pF
Reverse transfer capacitance	C_{rss}	$V_{DD} = 800\text{ V}$, $V_{GS} = 0\text{ V}$, $f = 100\text{ kHz}$, $V_{AC} = 25\text{ mV}$		1			pF
C_{oss} stored energy	E_{oss}	$V_{DD} = 800\text{ V}$, $V_{GS} = 0\text{ V}$, $f = 100\text{ kHz}$, $V_{AC} = 25\text{ mV}$		10.5			μJ
Total gate charge	Q_G	$V_{DD} = 800\text{ V}$, $I_D = 7\text{ A}$, $V_{GS} = 0/20\text{ V}$, turn-on pulse		18			nC
Plateau gate charge	$Q_{GS(pl)}$	$V_{DD} = 800\text{ V}$, $I_D = 7\text{ A}$, $V_{GS} = 0/20\text{ V}$, turn-on pulse		5			nC
Gate-to-drain charge	Q_{GD}	$V_{DD} = 800\text{ V}$, $I_D = 7\text{ A}$, $V_{GS} = 0/20\text{ V}$, turn-on pulse		3			nC
Turn-on delay time	$t_{d(on)}$	$V_{DD} = 800\text{ V}$, $I_D = 7\text{ A}$, $V_{GS} = 0/20\text{ V}$, $R_{G,ext} = 2\text{ }\Omega$, $L_\sigma = 20\text{ nH}$, diode: body diode at $V_{GS} = 0\text{ V}$	$T_{vj} = 25\text{ °C}$		5.2		ns
			$T_{vj} = 175\text{ °C}$		5.2		

(table continues...)

Table 4 (continued) **Characteristic values**

Parameter	Symbol	Note or test condition	Values			Unit
			Min.	Typ.	Max.	
Rise time	t_r	$V_{DD} = 800 \text{ V}, I_D = 7 \text{ A},$ $V_{GS} = 0/20 \text{ V}, R_{G,ext} = 2 \Omega,$ $L_\sigma = 20 \text{ nH},$ diode: body diode at $V_{GS} = 0 \text{ V}$	$T_{vj} = 25 \text{ }^\circ\text{C}$	4.3		ns
			$T_{vj} = 175 \text{ }^\circ\text{C}$	5		
Turn-off delay time	$t_{d(off)}$	$V_{DD} = 800 \text{ V}, I_D = 7 \text{ A},$ $V_{GS} = 0/20 \text{ V}, R_{G,ext} = 2 \Omega,$ $L_\sigma = 20 \text{ nH},$ diode: body diode at $V_{GS} = 0 \text{ V}$	$T_{vj} = 25 \text{ }^\circ\text{C}$	10.1		ns
			$T_{vj} = 175 \text{ }^\circ\text{C}$	11		
Fall time	t_f	$V_{DD} = 800 \text{ V}, I_D = 7 \text{ A},$ $V_{GS} = 0/20 \text{ V}, R_{G,ext} = 2 \Omega,$ $L_\sigma = 20 \text{ nH},$ diode: body diode at $V_{GS} = 0 \text{ V}$	$T_{vj} = 25 \text{ }^\circ\text{C}$	13.5		ns
			$T_{vj} = 175 \text{ }^\circ\text{C}$	14		
Turn-on energy	E_{on}	$V_{DD} = 800 \text{ V}, I_D = 7 \text{ A},$ $V_{GS} = 0/20 \text{ V}, R_{G,ext} = 2 \Omega,$ $L_\sigma = 20 \text{ nH},$ diode: body diode at $V_{GS} = 0 \text{ V}$	$T_{vj} = 25 \text{ }^\circ\text{C}$	38.4		μJ
			$T_{vj} = 175 \text{ }^\circ\text{C}$	53.1		
Turn-off energy	E_{off}	$V_{DD} = 800 \text{ V}, I_D = 7 \text{ A},$ $V_{GS} = 0/20 \text{ V}, R_{G,ext} = 2 \Omega,$ $L_\sigma = 20 \text{ nH},$ diode: body diode at $V_{GS} = 0 \text{ V}$	$T_{vj} = 25 \text{ }^\circ\text{C}$	25.7		μJ
			$T_{vj} = 175 \text{ }^\circ\text{C}$	27.7		
Total switching energy	E_{tot}	$V_{DD} = 800 \text{ V}, I_D = 7 \text{ A},$ $V_{GS} = 0/20 \text{ V}, R_{G,ext} = 2 \Omega,$ $L_\sigma = 20 \text{ nH},$ diode: body diode at $V_{GS} = 0 \text{ V}$	$T_{vj} = 25 \text{ }^\circ\text{C}$	64.1		μJ
			$T_{vj} = 175 \text{ }^\circ\text{C}$	80.8		
Virtual junction temperature	T_{vj}		-55		175	$^\circ\text{C}$

1) not subject to production test - verified by design/characterization

Note: Characteristics at $T_{vj} = 25^\circ\text{C}$, unless otherwise specified.

3 Body diode (MOSFET)

Table 5 **Maximum rated values**

Parameter	Symbol	Note or test condition	Values	Unit	
Drain-source voltage ¹⁾	V_{DSS}	$T_{vj} = -55\dots175 \text{ }^\circ\text{C}$	1200	V	
Continuous reverse drain current for $R_{th(j-c,max)}$, limited by $T_{vj(max)}$ ²⁾	I_{SDC}	$V_{GS} = 0 \text{ V}$	$T_c = 25 \text{ }^\circ\text{C}$	15.4	A
			$T_c = 100 \text{ }^\circ\text{C}$	13	
Peak reverse drain current, t_p limited by $T_{vj(max)}$ ²⁾	I_{SM}	$V_{GS} = 0 \text{ V}$	15.4	A	

1) Tested at $T_{vj}=25^\circ\text{C}$, verified by design/characterization over full temperature range

3 Body diode (MOSFET)

2) not subject to production test - verified by design/characterization

Table 6 Characteristic values

Parameter	Symbol	Note or test condition	Values			Unit
			Min.	Typ.	Max.	
Drain-source reverse voltage	V_{SD}	$I_{SD} = 7 \text{ A}, V_{GS} = 0 \text{ V}$	$T_{vj} = 25 \text{ °C}$	3.9	5	V
			$T_{vj} = 100 \text{ °C}$	3.8		
			$T_{vj} = 175 \text{ °C}$	3.7		
MOSFET forward recovery charge	Q_{fr}	$V_{DD} = 800 \text{ V},$ $I_{SD} = 7 \text{ A}, V_{GS} = 0 \text{ V},$ $-di_{SD}/dt = 1000 \text{ A}/\mu\text{s}, Q_{fr}$ includes also Q_C	$T_{vj} = 25 \text{ °C}$	72		nC
			$T_{vj} = 175 \text{ °C}$	143		
MOSFET peak forward recovery current	I_{frm}	$V_{DD} = 800 \text{ V},$ $I_{SD} = 7 \text{ A}, V_{GS} = 0 \text{ V},$ $-di_{SD}/dt = 1000 \text{ A}/\mu\text{s}, Q_{fr}$ includes also Q_C	$T_{vj} = 25 \text{ °C}$	5.3		A
			$T_{vj} = 175 \text{ °C}$	7.7		
Virtual junction temperature	T_{vj}		-55		175	°C

4 Characteristics diagrams

Reverse bias safe operating area (RBSOA)

$$I_{DS} = f(V_{DS})$$

$$T_{vj} \leq 175\text{ °C}, V_{GS} = 0/20\text{ V}, T_c = 25\text{ °C}$$

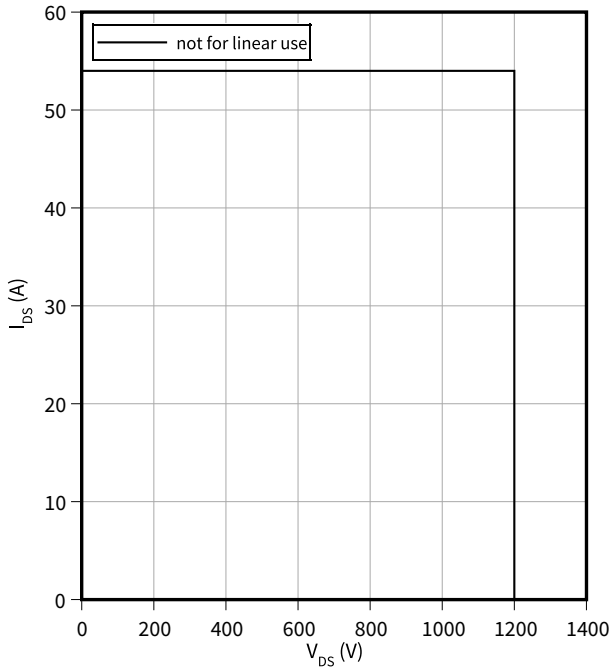

Power dissipation as a function of case temperature

$$P_{tot} = f(T_c)$$

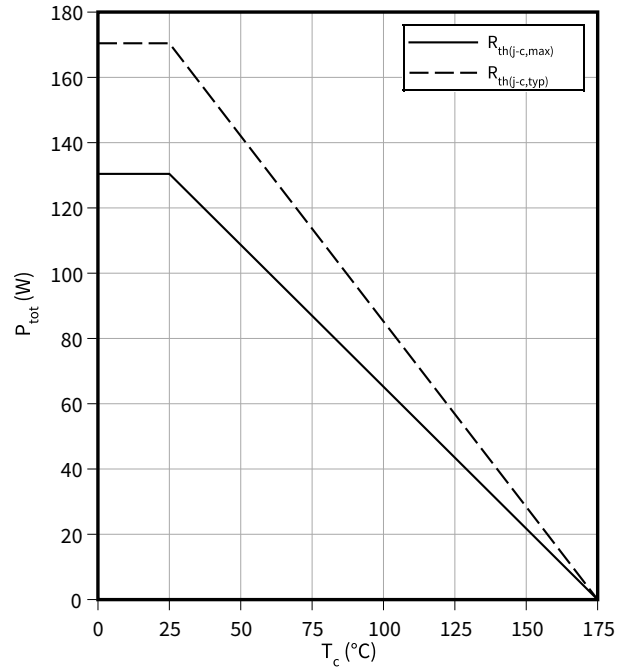

Maximum DC drain to source current as a function of case temperature

$$I_{DS} = f(T_c)$$

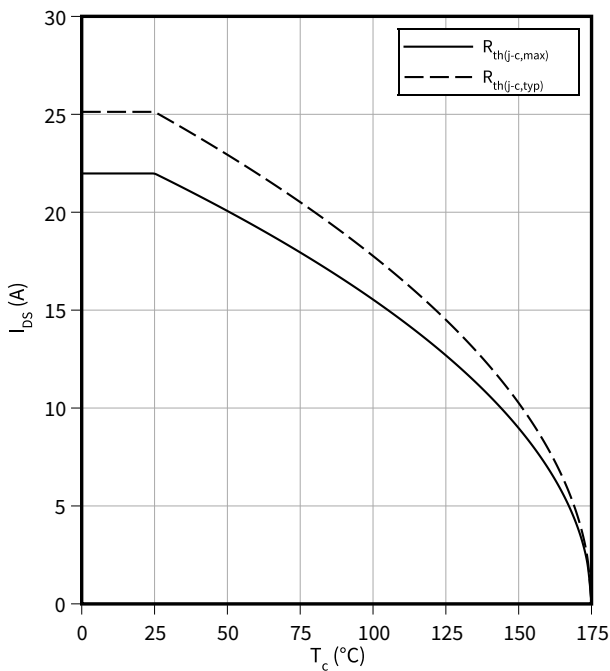

Maximum source to drain current as a function of case temperature

$$I_{SD} = f(T_c)$$

$$V_{GS} = 0\text{ V}$$

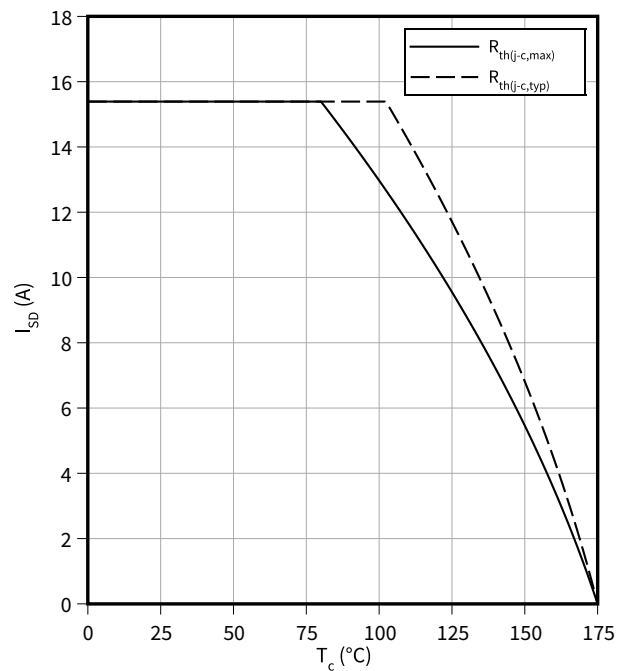

4 Characteristics diagrams

Typical transfer characteristic

$I_{DS} = f(V_{GS})$
 $V_{DS} = 20 \text{ V}, t_p = 20 \mu\text{s}$

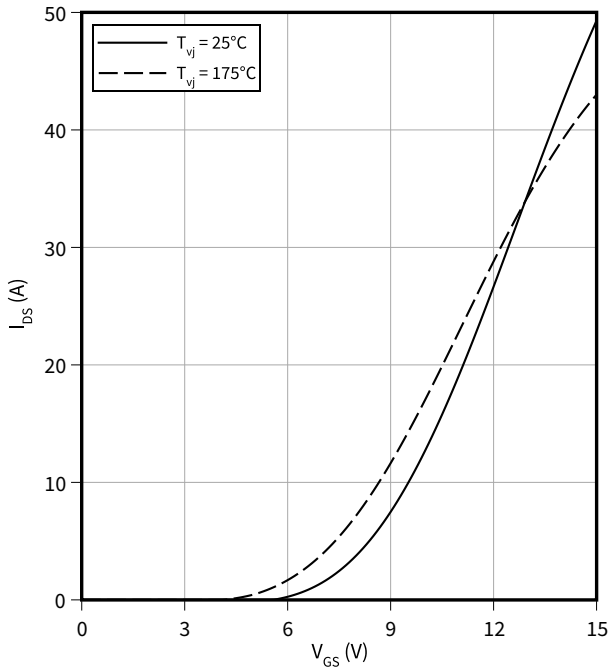

Typical gate-source threshold voltage as a function of junction temperature

$V_{GS(th)} = f(T_{vj})$
 $I_D = 2.2 \text{ mA}$

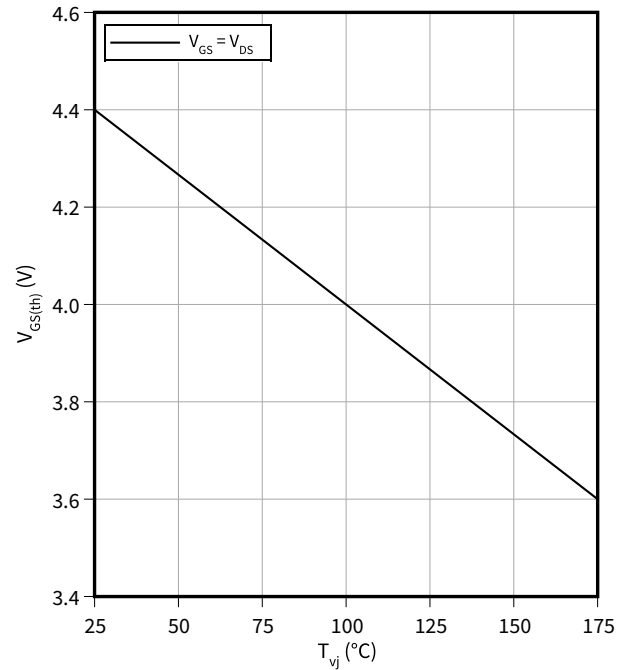

Typical output characteristic, V_{GS} as parameter

$I_{DS} = f(V_{DS})$
 $T_{vj} = 25 \text{ }^\circ\text{C}, t_p = 20 \mu\text{s}$

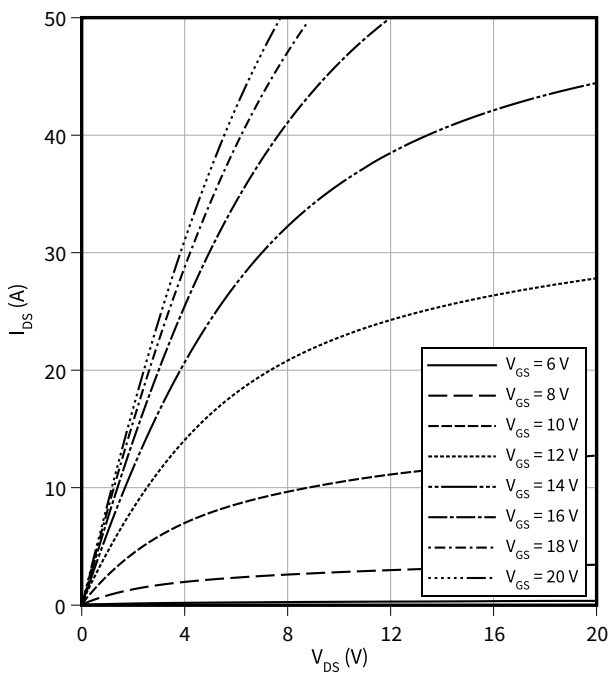

Typical output characteristic, V_{GS} as parameter

$I_{DS} = f(V_{DS})$
 $T_{vj} = 175 \text{ }^\circ\text{C}, t_p = 20 \mu\text{s}$

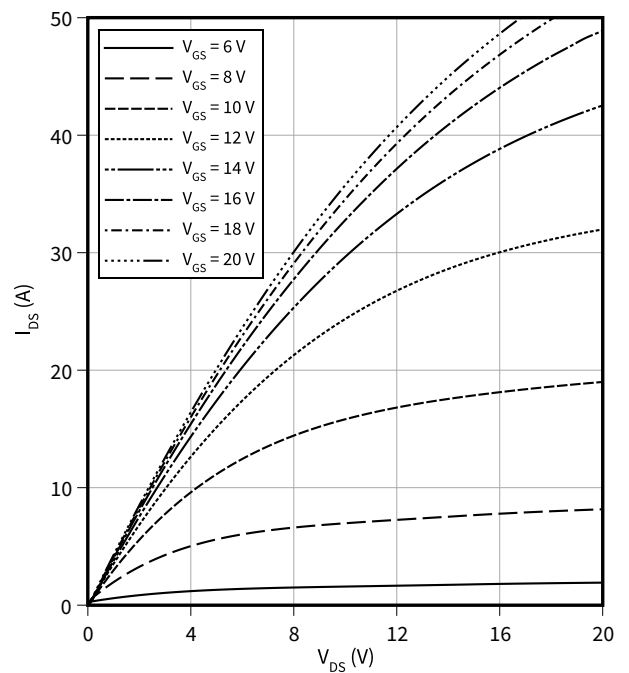

4 Characteristics diagrams

Typical on-state resistance as a function of junction temperature

$R_{DS(on)} = f(T_{vj})$
 $I_D = 7\text{ A}$

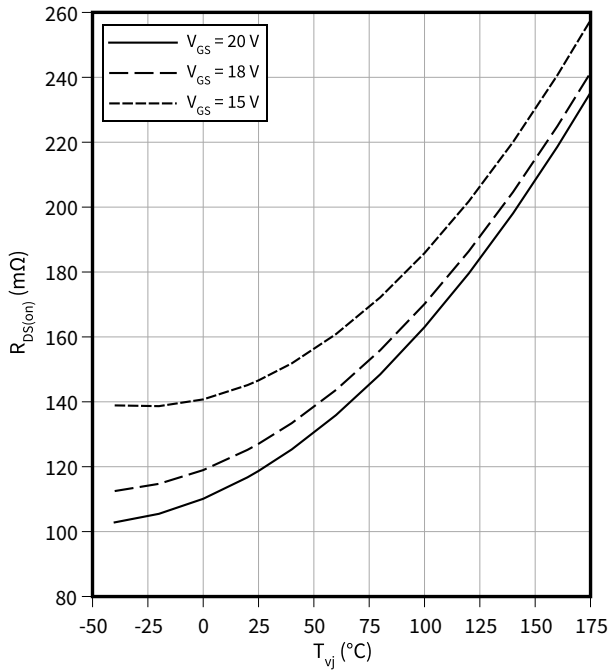

Typical gate charge

$V_{GS} = f(Q_G)$
 $I_D = 7\text{ A}, V_{DS} = 800\text{ V}$

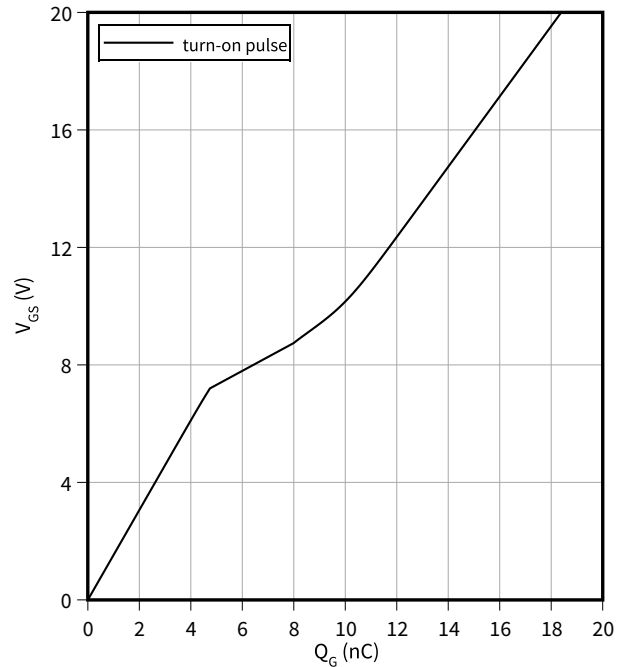

Typical capacitance as a function of drain-source voltage

$C = f(V_{DS})$
 $f = 100\text{ kHz}, V_{GS} = 0\text{ V}$

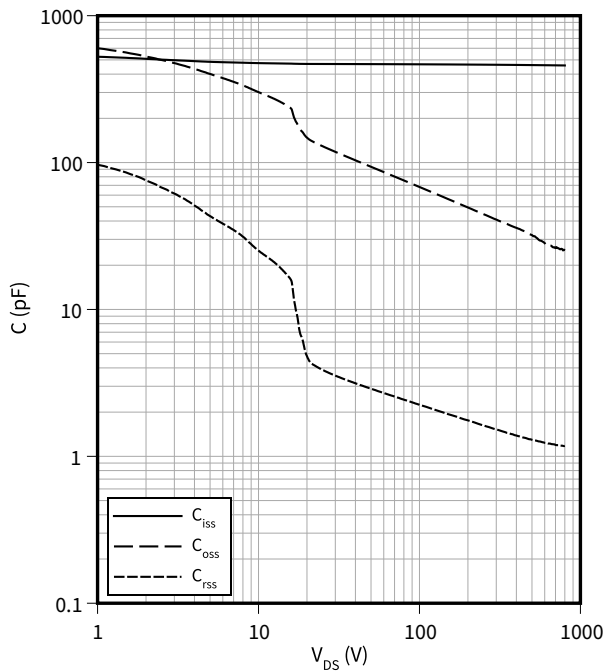

Typical C_{OSS} stored energy

$E_{OSS} = f(V_{DS})$
 $f = 100\text{ kHz}, V_{GS} = 0\text{ V}$

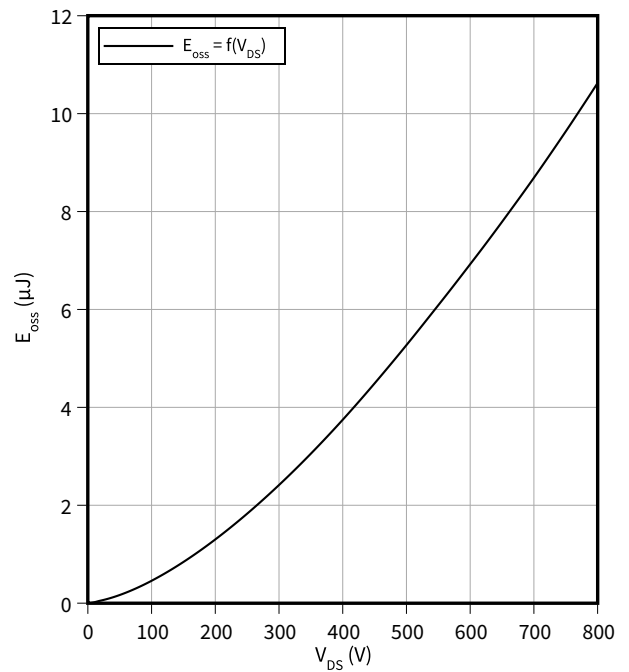

4 Characteristics diagrams

Typical reverse drain voltage as function of junction temperature

$V_{SD} = f(T_{vj})$
 $I_{SD} = 7 \text{ A}, V_{GS} = 0 \text{ V}$

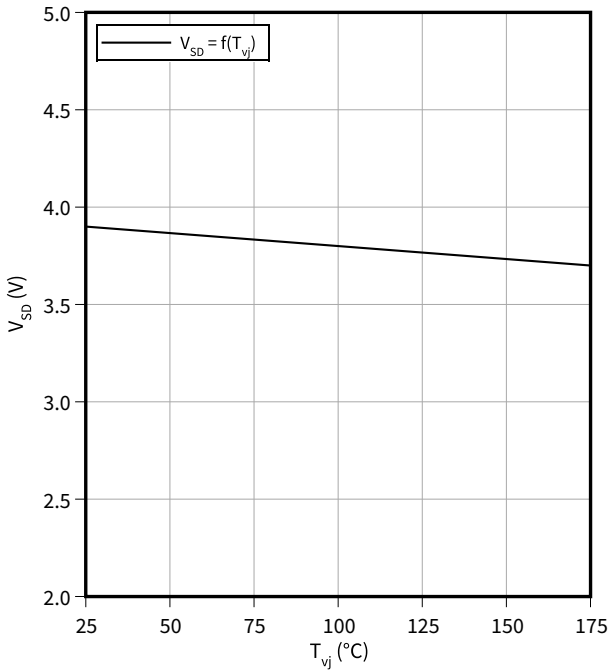

Typical reverse drain current as function of reverse drain voltage, V_{GS} as parameter

$I_{SD} = f(V_{SD})$
 $T_{vj} = 25 \text{ °C}, t_p = 20 \text{ } \mu\text{s}$

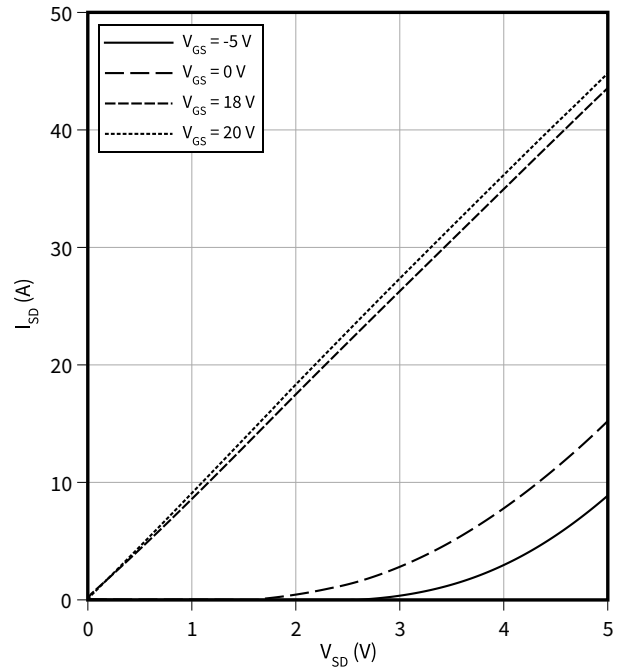

Typical reverse drain current as function of reverse drain voltage, V_{GS} as parameter

$I_{SD} = f(V_{SD})$
 $T_{vj} = 175 \text{ °C}, t_p = 20 \text{ } \mu\text{s}$

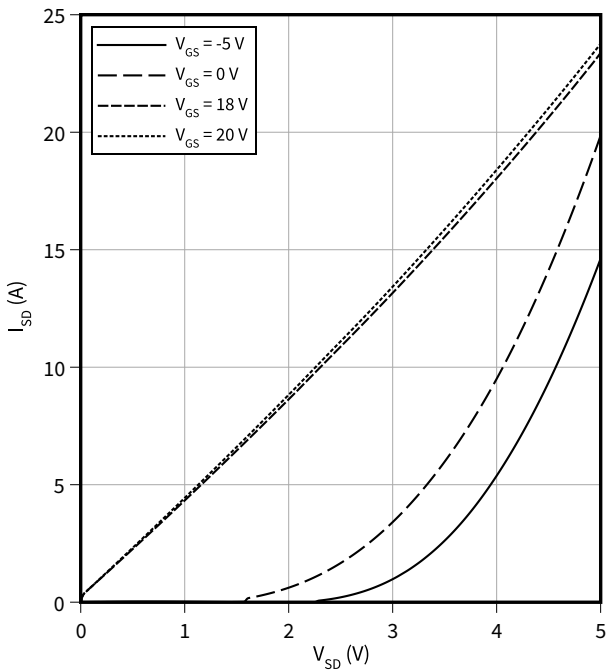

Typical switching energy as a function of junction temperature, test circuit in Fig. F, 2nd device own body diode: $V_{GS} = 0 \text{ V}$

$E = f(T_{vj})$
 $V_{GS} = 0/20 \text{ V}, I_D = 7 \text{ A}, R_{G,ext} = 2 \text{ } \Omega, V_{DD} = 800 \text{ V}$

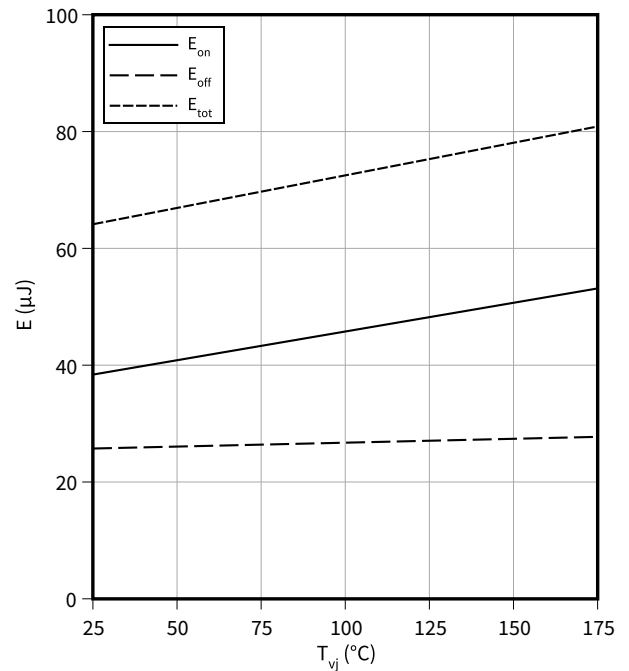

4 Characteristics diagrams

Typical switching energy as a function of drain current, test circuit in Fig. F, 2nd device own body diode: $V_{GS} = 0\text{ V}$

$E = f(I_D)$

$V_{GS} = 0/20\text{ V}$, $T_{vj} = 175\text{ °C}$, $R_{G,ext} = 2\ \Omega$, $V_{DD} = 800\text{ V}$

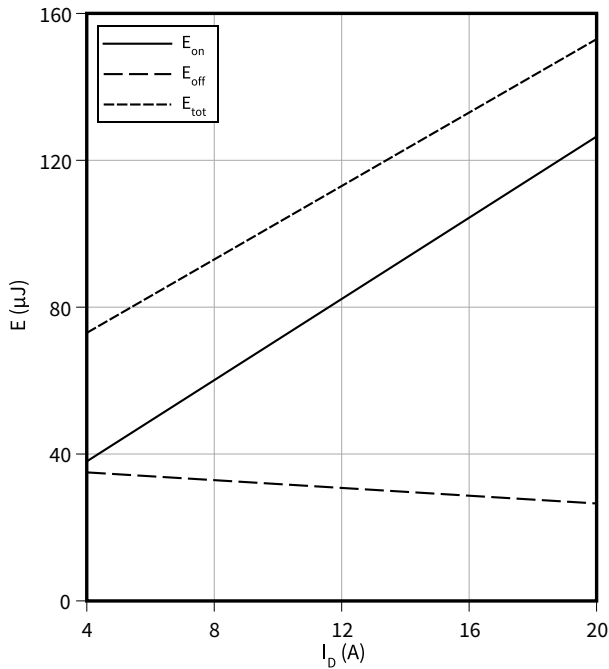

Typical switching energy as a function of gate resistance, test circuit in Fig. F, 2nd device own body diode: $V_{GS} = 0\text{ V}$

$E = f(R_{G,ext})$

$V_{GS} = 0/20\text{ V}$, $I_D = 7\text{ A}$, $T_{vj} = 175\text{ °C}$, $V_{DD} = 800\text{ V}$

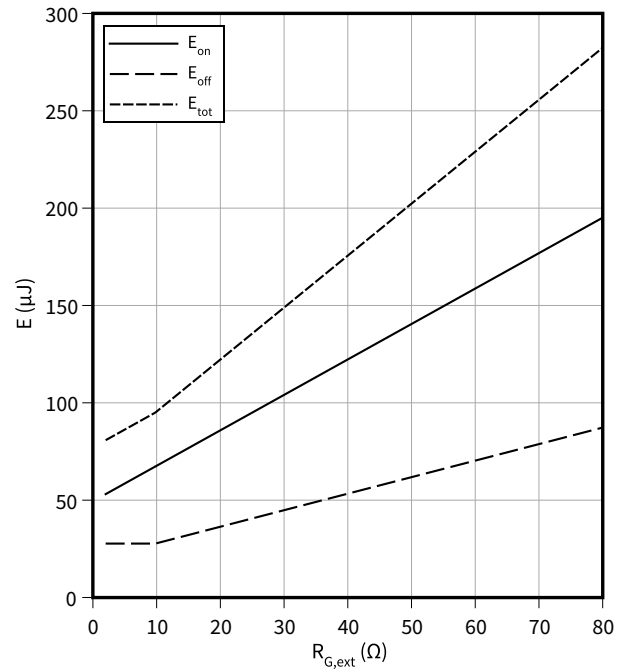

Typical switching times as a function of gate resistance, test circuit in Fig. F, 2nd device own body diode: $V_{GS} = 0\text{ V}$

$t = f(R_{G,ext})$

$V_{GS} = 0/20\text{ V}$, $I_D = 7\text{ A}$, $T_{vj} = 175\text{ °C}$, $V_{DD} = 800\text{ V}$

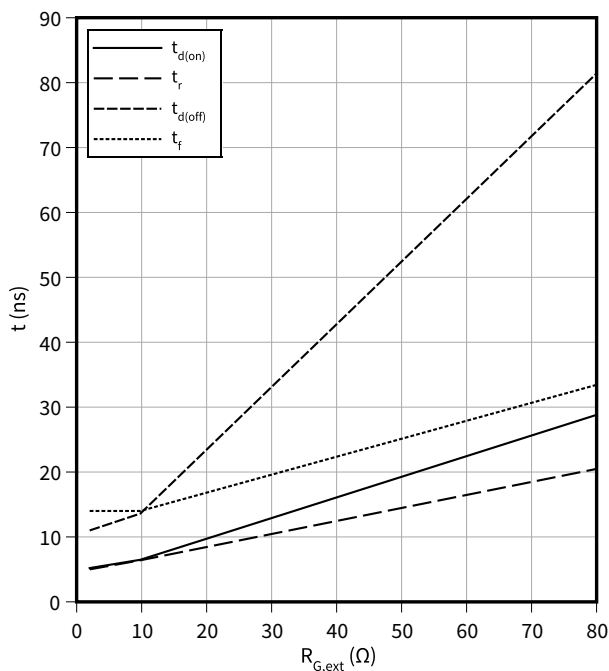

Typical MOSFET peak forward recovery current as a function of reverse drain current slope

$I_{frm} = f(-di_{SD}/dt)$

$V_{GS} = 0/20\text{ V}$, $I_{SD} = 7\text{ A}$, $V_{DD} = 800\text{ V}$

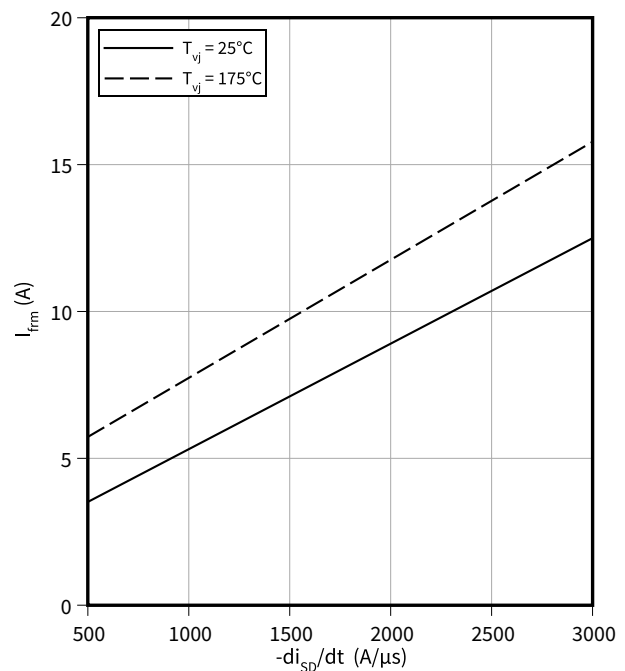

4 Characteristics diagrams

Max. transient thermal impedance (MOSFET/diode)

$$Z_{th(j-c),max} = f(t_p)$$

$$D = t_p/T$$

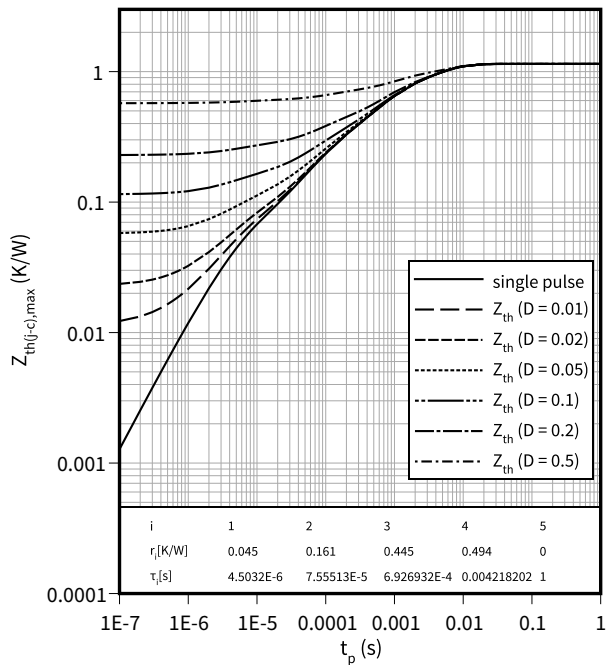

5 Package outlines

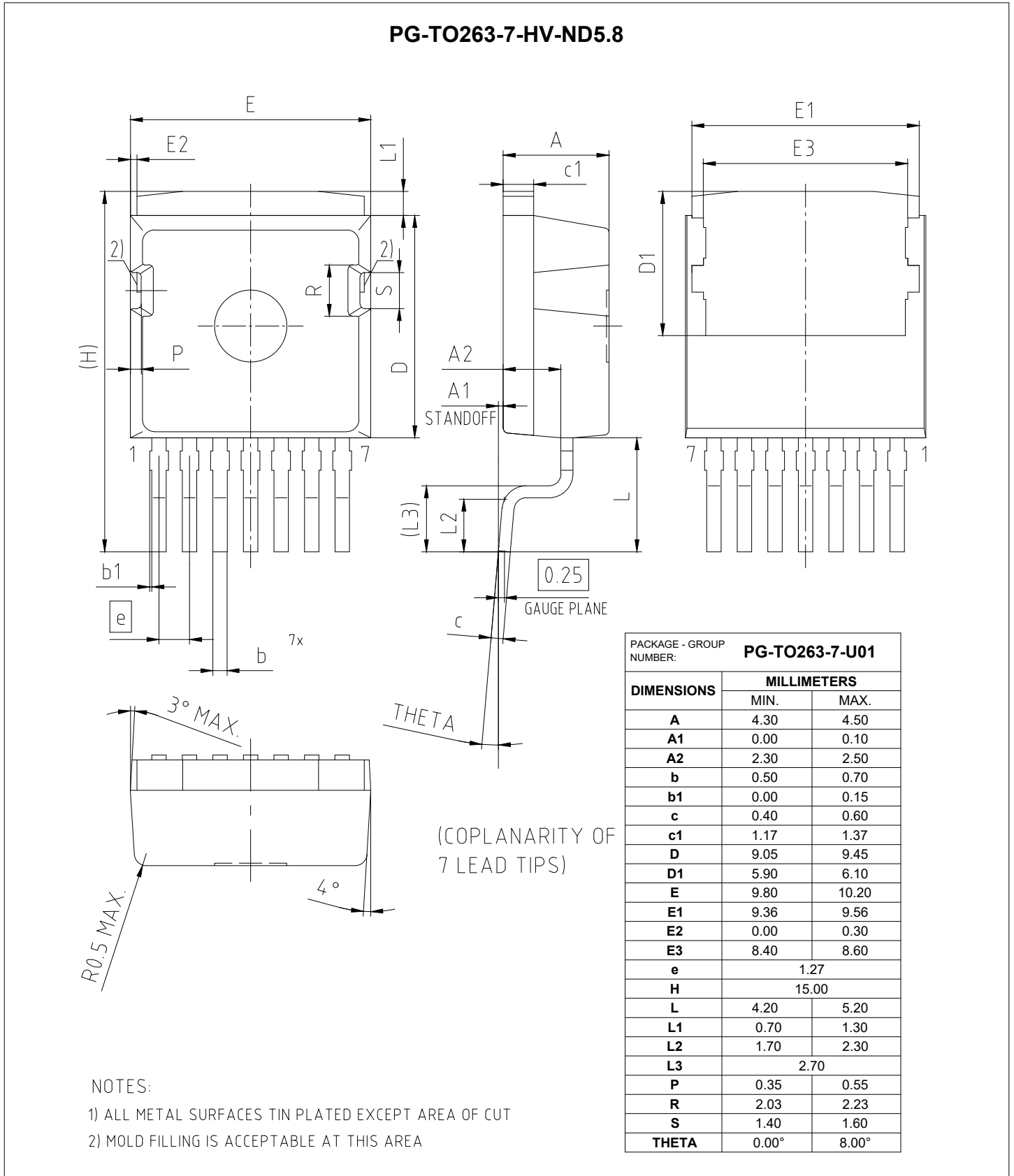

Figure 1

6 Testing conditions

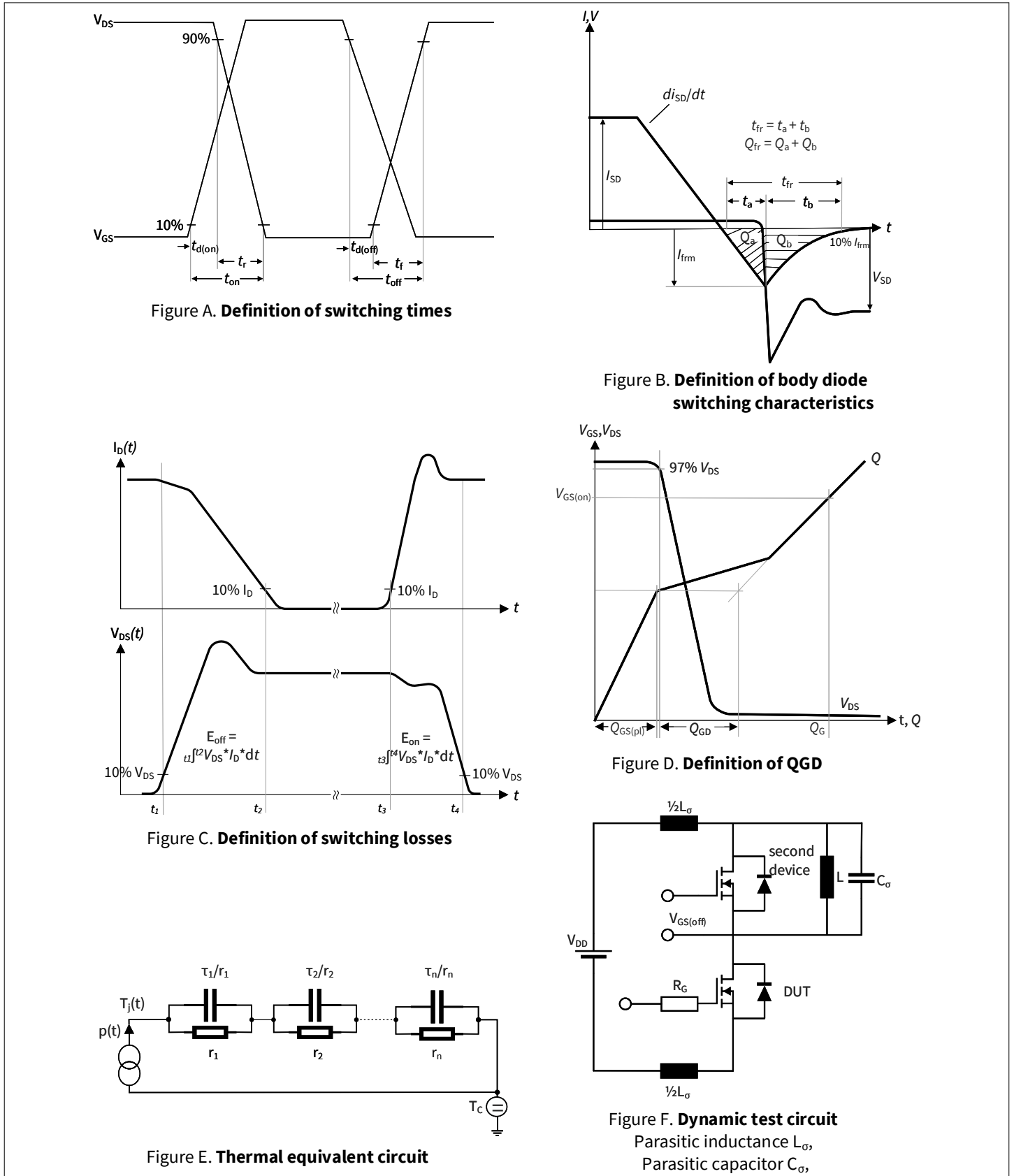

Figure 2

Revision history

Revision history

Document revision	Date of release	Description of changes
0.10	2022-12-08	Preliminary datasheet
1.00	2023-05-10	Final datasheet
1.10	2023-05-22	Final datasheet
1.20	2024-03-26	Updated table values: V_{gsth} , I_{dss} , g_{fs} , E_{oss} , t_{don} , t_r , t_{doff} , t_f , E_{on} , E_{off} , E_{tot} , Q_{fr} , I_{frm} , I_{sdc} , I_{sm} Updated graphs: $I_{DS} = f(V_{GS})$, $V_{GS(th)} = f(T_{vj})$, $I_{DS} = f(V_{DS})$, $R_{DS(on)} = f(T_{vj})$, $I_{SD} = f(V_{SD})$, $E = f(T_{vj})$, $E = f(R_{G,ext})$, $t = f(R_{G,ext})$, $I_{frm} = f(-diSD/dt)$ Added new graphs: $E = f(I_D)$, $E_{oss} = f(V_{DS})$ No change to the product, new values based on additional characterization

Trademarks

All referenced product or service names and trademarks are the property of their respective owners.

Edition 2024-03-26

Published by

Infineon Technologies AG

81726 Munich, Germany

© 2024 Infineon Technologies AG

All Rights Reserved.

Do you have a question about any aspect of this document?

Email: erratum@infineon.com

Document reference

IFX-ABG196-004

Important notice

The information given in this document shall in no event be regarded as a guarantee of conditions or characteristics ("Beschaffungsgarantie").

With respect to any examples, hints or any typical values stated herein and/or any information regarding the application of the product, Infineon Technologies hereby disclaims any and all warranties and liabilities of any kind, including without limitation warranties of non-infringement of intellectual property rights of any third party.

In addition, any information given in this document is subject to customer's compliance with its obligations stated in this document and any applicable legal requirements, norms and standards concerning customer's products and any use of the product of Infineon Technologies in customer's applications.

The data contained in this document is exclusively intended for technically trained staff. It is the responsibility of customer's technical departments to evaluate the suitability of the product for the intended application and the completeness of the product information given in this document with respect to such application.

Warnings

Due to technical requirements products may contain dangerous substances. For information on the types in question please contact your nearest Infineon Technologies office.

Except as otherwise explicitly approved by Infineon Technologies in a written document signed by authorized representatives of Infineon Technologies, Infineon Technologies' products may not be used in any applications where a failure of the product or any consequences of the use thereof can reasonably be expected to result in personal injury.