

3 Quadrants High temperature Triacs

General Description

High current density due to mesa technology , guaranteed maximum junction temperature 150° C. The AIS16CH triac series is suitable for general purpose AC switching. They can be used as an ON/OFF function in applications such as static relays, heating regulation, High power motor controls e.g. washing machines and vacuum cleaners, Rectifier-fed DC inductive loads e.g. DC motors and solenoids , motor speed controllers. The heatsink can be reduced, compared to traditional triacs, according to the high performance at given junction temperatures.

Features

- ◆ Repetitive Peak Off-State Voltage: 600V/800V
- ◆ R.M.S On-State Current ($I_{T(RMS)}$) = 16 A)
- ◆ High Commutation dv/dt
- ◆ Isolated heatsink mounted , Isolation Voltage (V_{iso} = 2500V AC)
- ◆ High junction temperature operating capability
- ◆ These Devices are Pb-Free and are RoHS Compliant

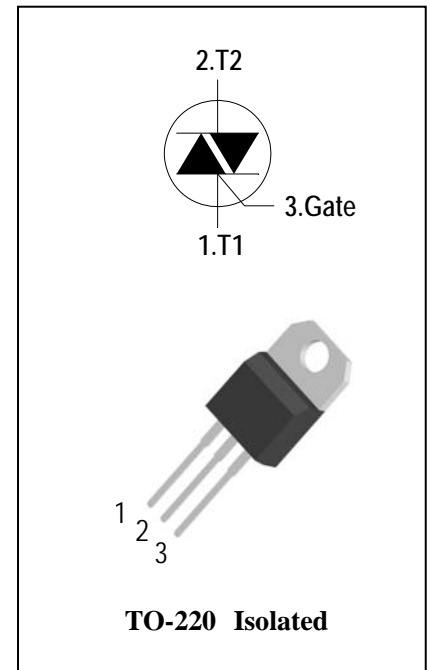

Absolute Maximum Ratings

Symbol	Items	Conditions		Ratings	Unit
V_{DRM} V_{RRM}	Repetitive Peak Off-State Voltage	$T_j = 25^\circ C$	AIS16CH60	600	V
			AIS16CH80	800	V
$I_{T(RMS)}$	R.M.S On-State Current	$T_C = 110^\circ C$		16	A
I_{TSM}	Surge On-State Current	$t_p=20ms(50Hz)/t_p=16.7ms(60Hz)$		160/168	A
I^2t	I^2t for fusing	$t_p=10ms$		144	A^2s
di/dt	Critical rate of rise of on-state current	$F = 120 Hz T_j = 150^\circ C$ $I_G = 2 \times I_{GT} , t_r \leq 100 ns$		50	$A/\mu s$
I_{GM}	Peak Gate Current	$t_p = 20 \mu s T_j = 150^\circ C$		4	A
$P_{G(AV)}$	Average Gate Power Dissipation($T_j=150^\circ C$)			1	W
P_{GM}	Peak Gate Power Dissipation($t_p=20\mu s, T_j=150^\circ C$)			5	W
T_j	Operating Junction Temperature			- 40 ~ 150	$^\circ C$
T_{STG}	Storage Temperature			- 40 ~ 150	$^\circ C$



Electrical Characteristics (T_j = 25°C unless otherwise specified)

Symbol	Items		Conditions		AIS16CH60/80			Unit
					S	Blank	B	
I _{DRM} I _{RRM}	Peak Forward Reverse Blocking Current		V _{DRM} = V _{RRM} , T _j = 25°C V _{DRM} = V _{RRM} , T _j = 150°C	Max.	5 6			uA mA
V _{TM}	Peak On-State Voltage		I _{TM} = 22.5A, t _p = 380 μs	Max.	1.55			V
V _{GD}	Q1-Q2-Q3	Non-Trigger Gate Voltage	V _D = V _{DRM} R _L = 3.3 kΩ T _j = 150°C	Min.	0.2			V
V _{GT}	Q1-Q2-Q3	Gate Trigger Voltage	V _D = 12V , R _L = 33Ω	Max.	1.5			V
I _{GT}	Q1-Q2-Q3	Gate Trigger Current		Max.	10	35	50	mA
I _H	Q1-Q2-Q3	Holding Current	I _T = 0.1A	Max.	20	45	60	mA
I _L	Q1-Q3	Latching Current	I _G = 1.2 I _{GT}	Max.	20	50	70	mA
	Q2				35	70	100	
dV/dt	Critical Rate of Rise of Off-State Voltage		V _D = 2/3V _{DRM} gate open T _j = 150°C	Min.	500	1000	1500	V/μs
(dV/dt) _c	Critical Rate of Change of Commutating Voltage		V _D =400V(dI/dt) _c =-7A/ms T _j = 150°C	Min.	1	15	20	V/μs
R _{th(j-c)}	Junction to case (AC)			Max.	2.1			°C/W
R _{th(j-a)}	Junction to ambient			Max.	60			°C/W

FIG.1:Triac quadrant are defined and the gate trigger test circuit



FIG.2: Maximum on-state power dissipation

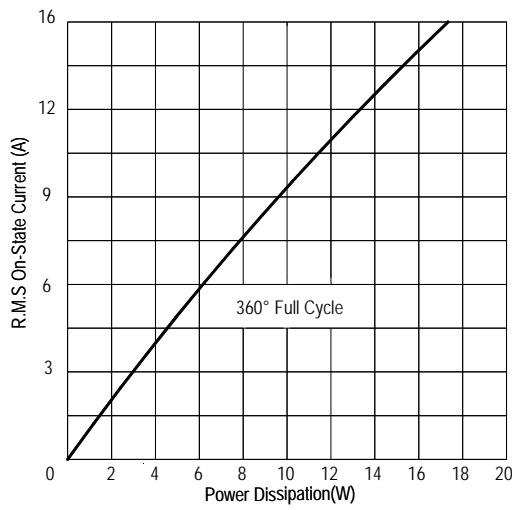

FIG.3: Typical RMS on-state current VS Allowable case Temperature

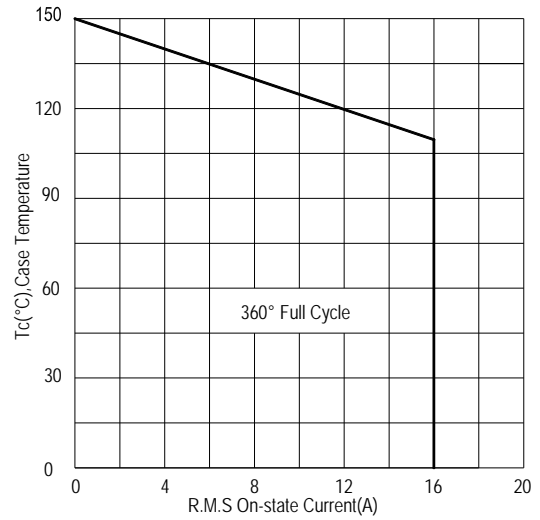

FIG.4: Maximum transient thermal impedance

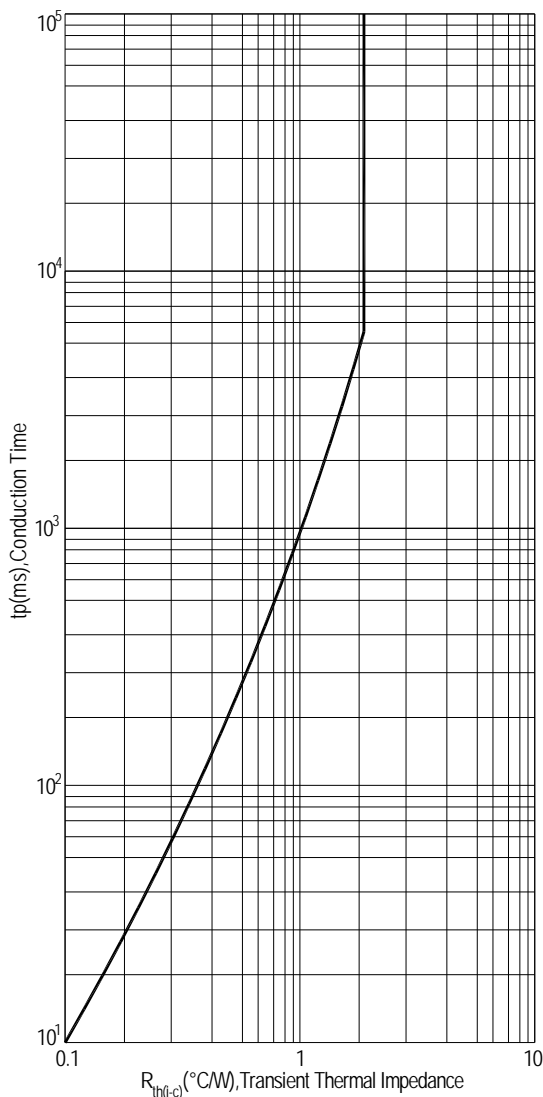

FIG.5: Rated surge on-state current (Non-Repetitive)

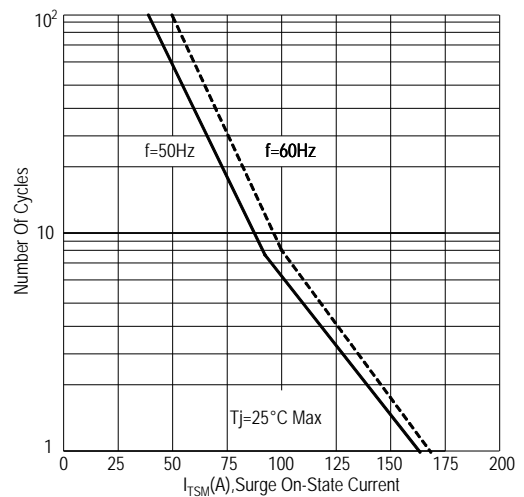

FIG.6: Gate trigger current VS Junction temperature

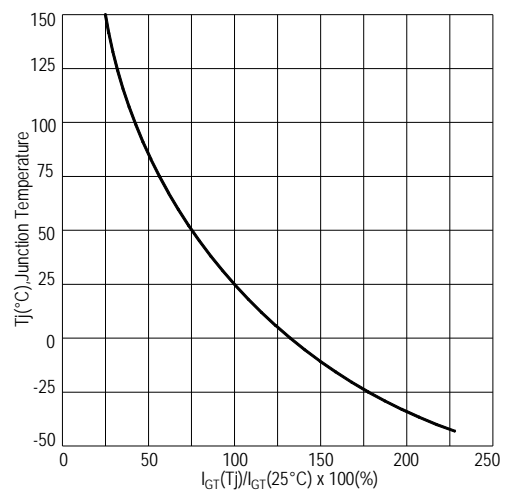

FIG.7: Holding current and Latching current VS Junction temperature

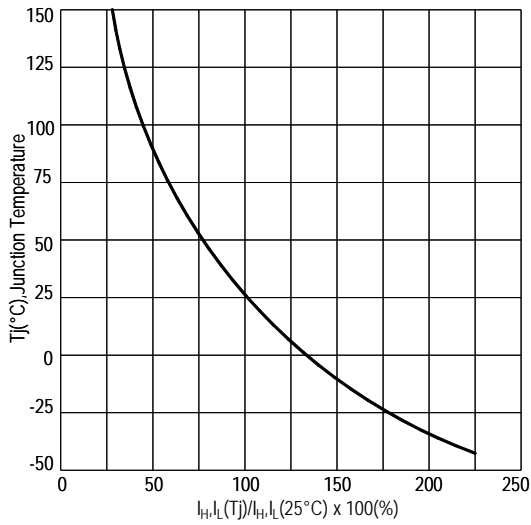

FIG.8: Gate trigger voltage VS Junction temperature

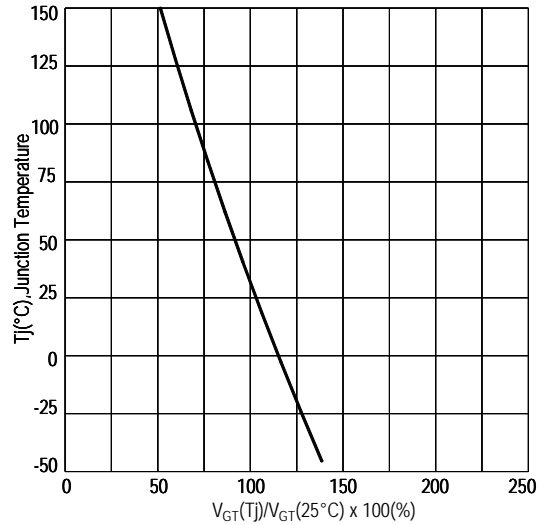
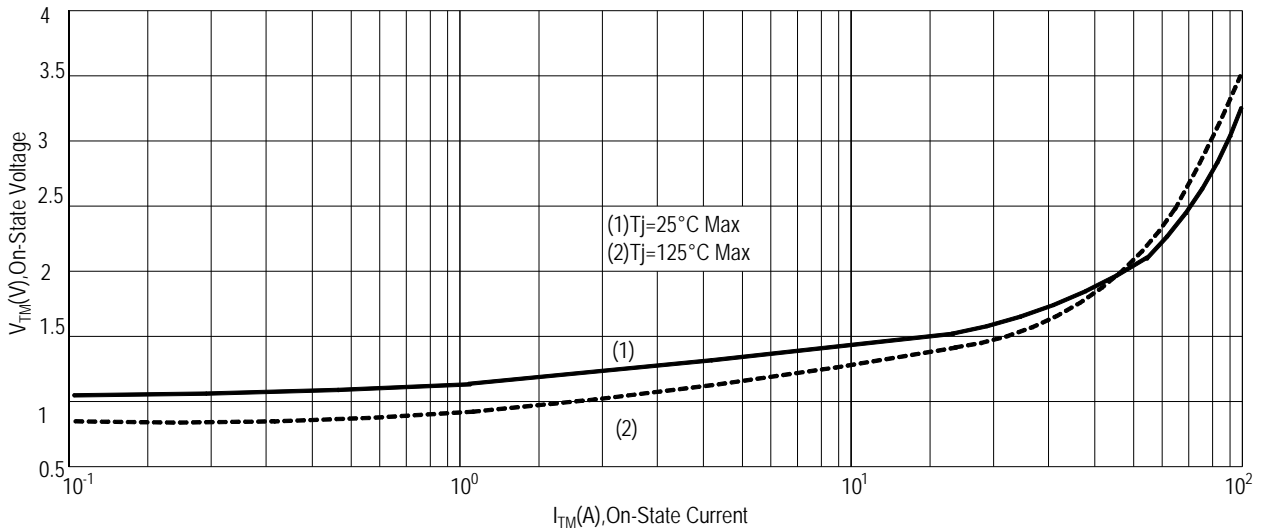
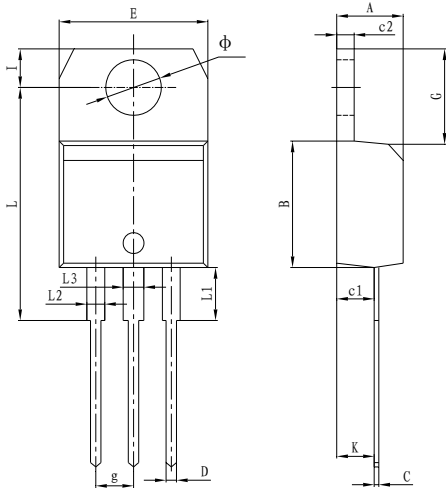

FIG.9: On-state characteristics(Max)



PACKAGE MECHANICAL DATA

TO-220(isolated) Package Dimension



Symbol	Dimensions In Millimeters		Dimensions In Inches	
	Min	Max	Min	Max
A	4.40	4.60	0.173	0.181
B	9.00	9.30	0.354	0.366
C	0.40	0.60	0.015	0.023
c1	2.00	2.60	0.078	0.102
c2	1.23	1.32	0.048	0.051
D	0.70	1.00	0.027	0.039
E	10.00	10.40	0.393	0.409
g	2.40	2.70	0.094	0.106
G	6.20	6.80	0.244	0.267
I	2.65	2.95	0.104	0.116
L	15.80	16.80	0.622	0.661
L1	3.75		0.147	
L2	1.14	1.70	0.044	0.066
L3	1.14	1.70	0.044	0.066
Φ	3.60	3.90	0.141	0.153
K	2.60TYP		0.102TYP	

Making Diagram

ADV: Logo
 AIS16CH60B: Part number
 X: Internal control code
 H: Halogen Free

A I S 16 C H 60 S(B)

<p>ADVANCED</p> <p>TO-220isolated</p> <p>Internal control code</p> <p>Current: 16=16A</p> <p>Quadrant: C=3Q</p> <p>High temperature: H=150°C</p>	<p>Sensitivity and type: S=10mA Blank=35mA B=50mA</p> <p>Voltage: 60=600V 80=800V</p>
--	---

Ordering information

Part number	Package	Marking	Packing	Quantity
AIS16CH60#	TO-220isolated	AIS16CH60#	Tube	50pcs
AIS16CH80#	TO-220isolated	AIS16CH80#	Tube	50pcs

Note: # = Gate Trigger Current Sensitivity and type

Notice

1. All information included in this document such as product data, diagrams, charts, programs, algorithms, and application circuit examples, is current as of the date this document is issued. Such information, however, is subject to change without any prior notice. Before purchasing or using any ADV products listed in this document, please confirm the latest product information with a ADV sales office. Also, please pay regular and careful attention to additional and different information to be disclosed by ADV such as that disclosed through our website. (<http://www.advsemi.com>)
2. ADV has used reasonable care in compiling the information included in this document, but ADV assumes no liability whatsoever for any damages incurred as a result of errors or omissions in the information included in this document.
3. You should use the products described herein within the range specified by ADV, especially with respect to the maximum rating, operating supply voltage range, movement power voltage range, heat radiation characteristics, installation and other product characteristics. ADV shall have no liability for malfunctions or damages arising out of the use of ADV products beyond such specified ranges.
4. When using or otherwise relying on the information in this document, you should evaluate the information in light of the total system before deciding about the applicability of such information to the intended application. ADV makes no representations, warranties or guaranties regarding the suitability of its products for any particular application and specifically disclaims any liability arising out of the application and use of the information in this document or ADV products.
5. Although ADV endeavors to improve the quality and reliability of its products, IC products have specific characteristics such as the occurrence of failure at a certain rate and malfunctions under certain use conditions. Please be sure to implement safety measures to guard against the possibility of physical injury, and injury or damage caused by fire in the event of the failure of a ADV product, such as safety design for hardware and software including but not limited to redundancy, fire control and malfunction prevention, appropriate treatment for aging degradation or any other applicable measures. Among others, since the evaluation of microcomputer software alone is very difficult, please evaluate the safety of the final products or system manufactured by you.
6. This document is provided for reference purposes only so that ADV customers may select the appropriate ADV products for their use. ADV neither makes warranties or representations with respect to the accuracy or completeness of the information contained in this document nor grants any license to any intellectual property rights or any other rights of ADV or any third party with respect to the information in this document.
7. ADV shall have no liability for damages or infringement of any intellectual property or other rights arising out of the use of any information in this document, including, but not limited to, product data, diagrams, charts, programs, algorithms, and application circuit examples.
8. This document may not be reproduced or duplicated, in any form, in whole or in part, without prior written approval from ADV.