



AK1291

IF Variable Gain Amplifier with RSSI

1. Overview

AK1291 is a variable gain amplifier with a power detector. It's operating frequency ranges from 100MHz to 300MHz. The gain control adopts an analog signal control, and the gain characteristic is dB linear. The gain control range is -9dB to +21dB and a dynamic range is 30dB. AK1291 has single-ended input and output, with impedance of 50 Ω. As a typical characteristic, NF is 7dB (at maximum gain) , and IMD3 is 70dBc at output power of -15dBm ,at frequency of 165MHz.The power supply voltage is 4.75V to 5.25V.

2. Feature

•Operation Frequency Range	100MHz to 300MHz
•Gain variable range	-9dB to 21dB
•Noise Figure	7dB @max gain
•IMD3	70dBc @output power -15dBm
•Supply Voltage	4.75V to 5.25V
•Operating Temperature	-40°C to +85°C
•Package	24pin QFN0404

3. Block Diagram

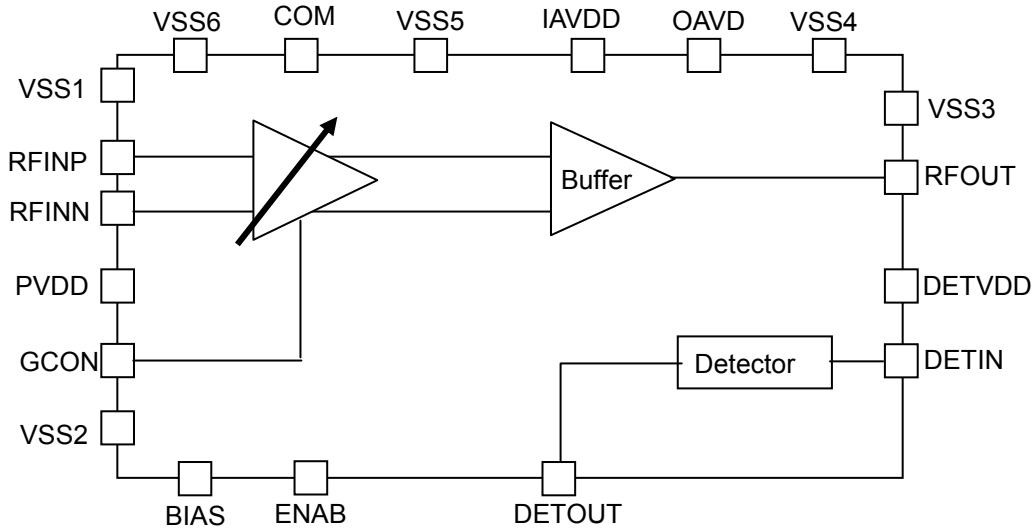

Fig 1. Block Diagram

Content

1. Overview	1
2. Feature	1
3. Block Diagram	1
4. Pin Configuration	3
5. Pin function Description.....	4
6. Maximum Absolute Rating	5
7. Recommended operational condition.....	5
8. Electrical Characteristic	6
9. Interface circuit.....	8
10. Evaluation Board Schimatic.....	10
11. Typical Performance	11
12. Marking	13
13. Outer Dimensions.....	14

4. Pin Configuration

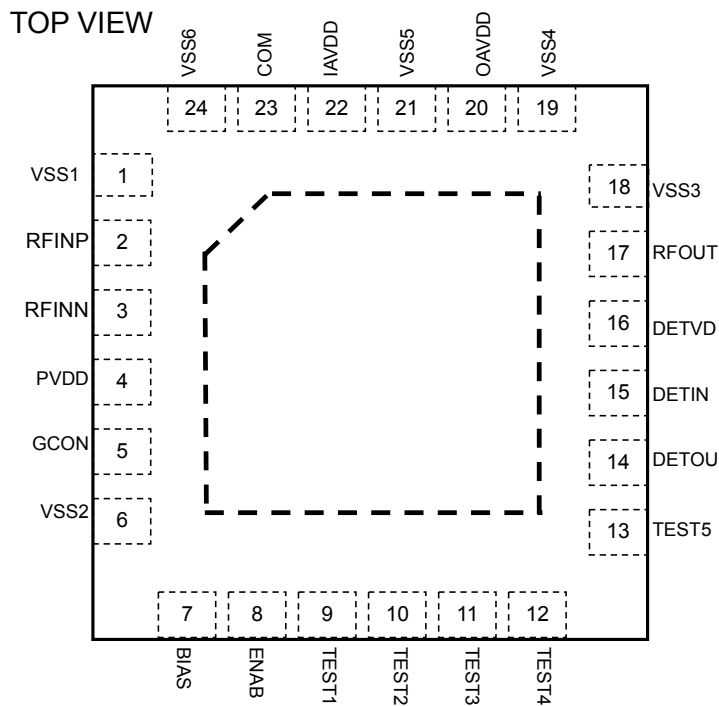

Fig 2 Pin Configuration

5. Block Function

Block	Function
VGA	Variable Gain Amplifier which is controlled by the voltage of 0.2 to 2.5V
Power Detector	Power detector which detect power level of VGA output

6. Pin function Description

Table 1. Pin function

Pin No	Name	I/O	function	Remark
1	VSS1	G	Ground	
2	RFINP	AI	RF input Positive	
3	RFINN	AI	RF input Negative	
4	PVDD	P	Power Supply	
5	GCON	AI	Control voltage input	
6	VSS2	G	Ground	
7	BIAS	AIO	Resistance connection pin for current adjustment	No resistance is connected.
8	ENAB	DI	Power down control	ENAB="High" Power on ENAB="Low" Power down
9	TEST1	DI	Test pin	Connect to ground
10	TEST2	DI	Test pin	Connect to ground
11	TEST3	DI	Test pin	Connect to ground.
12	TEST4	DI	Test pin	Connect to ground
13	TEST5	DO	Test pin	Connectionless
14	DETOUT	AO	Detector output	connect a capacitor of 10pF to ground
15	DETIN	AI	Detector input	connect a resistor of 50Ω to ground
16	DETVDD	P	Power supply	
17	RFOUT	AO	RF output	
18	VSS3	G	Ground	
19	VSS4	G	Ground	
20	OAVDD	P	Power supply	
21	VSS5	G	Ground	
22	IAVDD:	P	Power supply	
23	COM	AIO	Pin for input common voltage	connect a capacitor of 10nF to ground
24	VSS6	G	Ground	
25	EXPAD	G	Ground	The exposed pad at the center of the backside should be connected to ground.

Note) the exposed pad at the center of the backside should be connected to ground.

AI: Analog input pin	AO: Analog output pin	DI: Digital Input pin	DO: Digital Output pin
P: Power supply pin	G: Ground pin		

* About power down control: The power down of the whole IC is done by ENAB (pin8). In the case that ENAB is "High", VGA block and Detector block are power on state. In the case that let only Detector block power down, connect DETVDD to the ground.

7. Absolute Maximum Rating

Table 2. Absolute Maximum rating

項目	記号	Min.	Max.	単位	備考
Supply Voltage	VDD	-0.3	5.5	V	Applied to [PVDD], [IAVDD], [OAVDD], [DETVDD] note1)
Ground Level	VSS	0	0	V	Applied to [VSS1], [VSS2], [VSS3], [VSS4], [VSS5], [VSS6] and [EXPAD]
Analog input voltage	VAIN	-0.3	VDD+0.3	V	Applied to [RFINP], [RFINN], [GCON] and [DETIN]
	VDIN	-0.3	VDD+0.3	V	Applied to [ENAB] note1)
RFINP/RFINN Maximum input Level	Pmax		+10	dBm	
Storage Temperature	Tstg	-55	125	°C	

Note1) All voltage reference ground Level: 0V

Exceeding these maximum ratings may result in damage to the AK1291. Normal operation is not guaranteed at these extremes

8. Recommended operational condition

Table 3. Recommended operational condition

項目	記号	Min.	Typ.	Max.	単位	備考
Operating Temperature	Ta	-40		85	°C	
Supply Voltage	VDD	4.75	5	5.25	V	Applied to [PVDD], [IAVDD], [OAVDD], and [DETVDD]

Each specification is applied in the power supply voltage and the operating temperature applied to recommended operational condition.

9. Electrical Characteristic

DC Characteristic

Item	Symbol	Condition	Min.	Typ.	Max.	Unit
High Level Input Voltage	V _{IH}	Note1)	0.8*VDD			V
Low Level Input Voltage	V _{IL}	Note1)	0.0		0.2*VDD	V
Input leak current	I _{IL}	Note1)	-10		10	μA
Current consumption 1	ICC1	PVDD=OAVDD=IAVDD=DET VDD=VDD, ENAB=High		155	199	mA
Current consumption 2	ICC2	PVDD=OAVDD=IAVDD=VDD, DET=VSS, ENAB=High		151	195	mA
Current consumption 3	ICC3	PVDD=OAVDD=IAVDD=VDD, DET=VSS, ENAB=Low		10		μA

Note1) Applied to [ENAB] pin.

AC Characteristic

PVDD=OAVDD=IAVDD=4.75V~5.25V, T_a=-40°C~85°C f₀=165MHz, unless otherwise specified

Item	Symbol	Condition	Min.	Typ.	Max.	Unit
VGA Block						
Input Frequency	F _{OP}		100		300	MHz
Input Impedance	I _{IMP}			50		Ω
Output Impedance	O _{IMP}			50		Ω
Gain control Range	G _{CONT}			30		dB
Max. Gain	G _{MAX}	GCON=2.5V	21			dB
Min. Gain	G _{MIN}	GCON=0.2V			-6.5	dB
Gain 1	Ga1	GCON=2V		21		dB
Gain 2	Ga2	GCON=0.5V		-9		dB
Gain control voltage range	V _{GT}		0.2		2.5	V
Gain curve slope note1)	G _{CS}	0.5V ≤ VGCONT ≤ 2.0V	1	20	80	dB/V
Gain step response	G _{SR}			5		μS
<RFIN=100MHz>						
Noise Figure note2)	NF	Gain = 21 dB		7		dB
Output P1dB	OP1			5		dBm
IMD3	IMD3	Output Level = -15dBm	65	70		dBc
<RFIN=165MHz>						
Noise Figure note2)	NF	Gain = 21 dB		7		dB
Output P1dB	OP1			5		dBm
IMD3	IMD3	Output Level = -15dBm	65	70		dBc
<RFIN=300MHz>						
Noise Figure note2)	NF	Gain = 21 dB		7		dB
Output P1dB	OP1			5		dBm
IMD3	IMD3	Output Level = -15dBm	55	60		dBc

Detector Block						
Input Frequency range	F_{OP2}		100		500	MHz
Output voltage Level 1	Det_H	DETIN=-15dBm		1.6	2.2	V
Output voltage Level 2	Det_H	DETIN=-35dBm	0.5	0.9		V
Temperature dependency note 2)	Detvdev	Refer to 25°C		± 1		dB

Note1) guaranteed monotonicity

Note2) guaranteed by design

10. Interface circuit

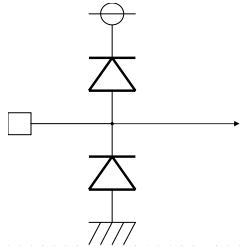
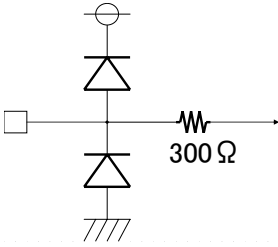
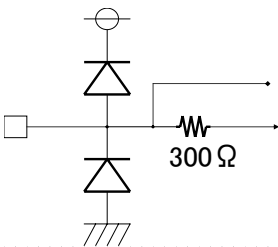
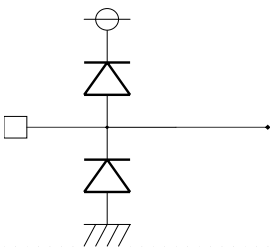
Pin No	Pin Name	I/O	Interface circuit
2	RFINP	I	RF input 
3	RFINN		
5	GCON	I	Analog Input 
7	BIAS	I/O	Analog Input/Output 
23	COM		
17	RFOUT	O	RF output 

Pin No.	Pin Name	I/O	Interface Circuit
8	ENAB	I	Digital input Pull-Down
9	TEST1		
10	TEST2		
11	TEST3		
12	TEST4		
13	TEST5	O	Digital output
14	DETOUT	O	Output
15	DETIN	I	RF input

11. Evaluation Board Schimatic

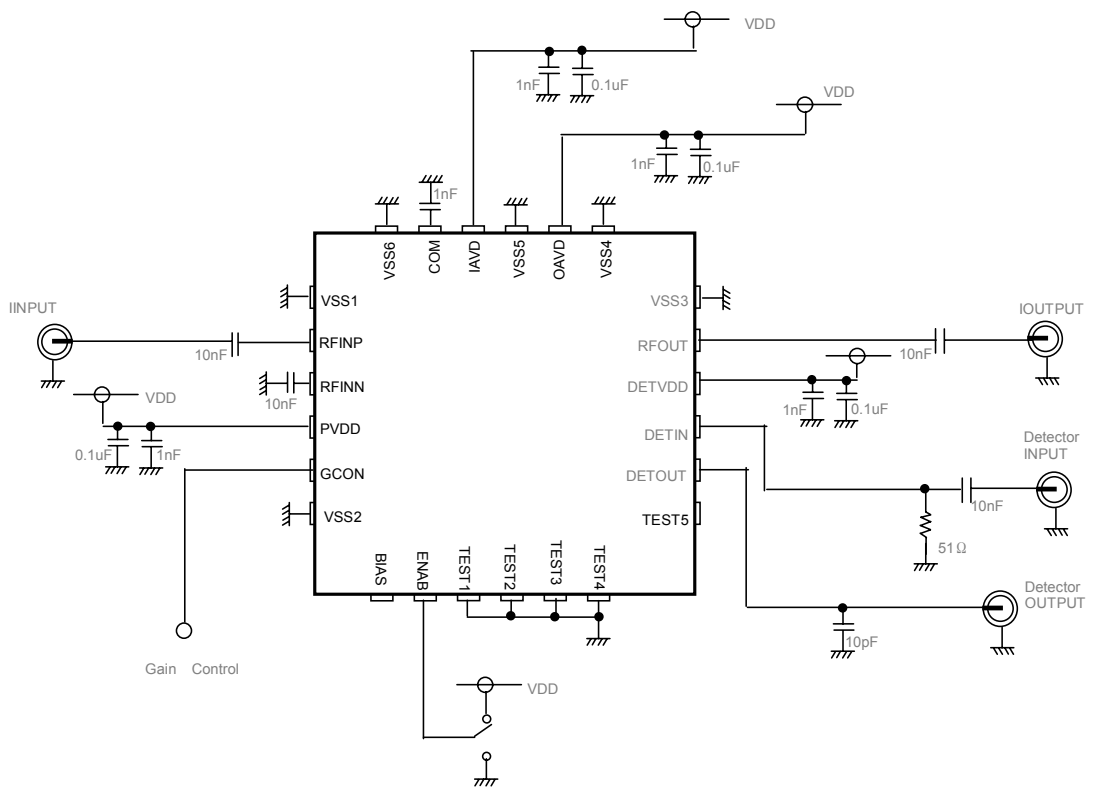

Fig 3. Typical Evaluation Board Schimatic

12. Typical Performance

Unless otherwise noted, PVDD=OAVDD=IAVDD=DETVDD=5V, Ta=25°C, Freq=165MHz

1. Gain vs Analog Control Voltage

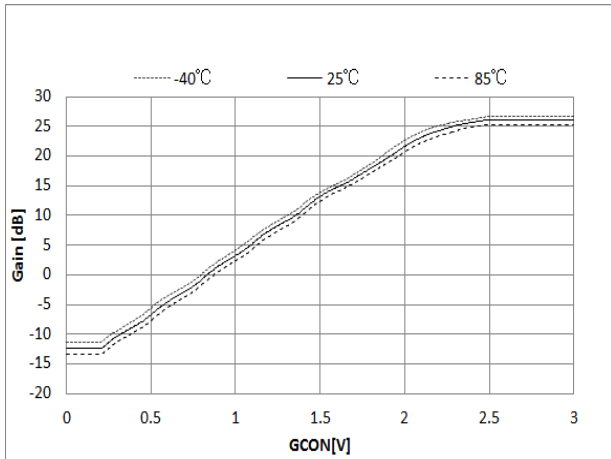

Fig.4-1 Gain VS Control Voltage(fo=100MHz)

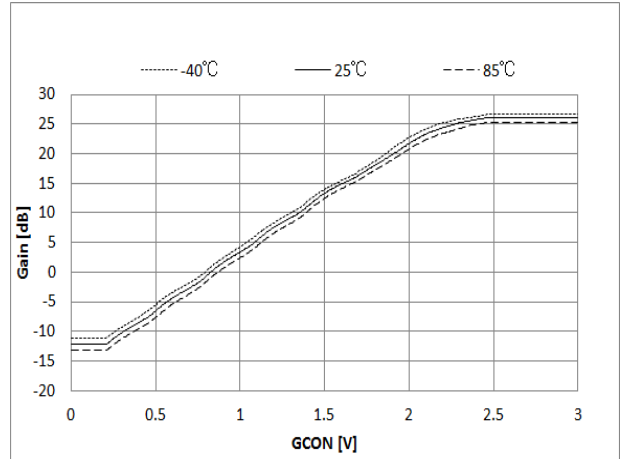

Fig.4-1 Gain VS Control Voltage(fo=165MHz)

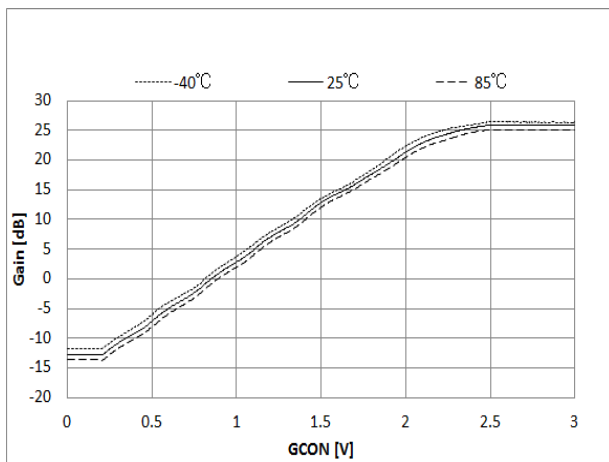

Fig.4-1 Gain VS Control Voltage(fo=300MHz)

2. Noise Figure

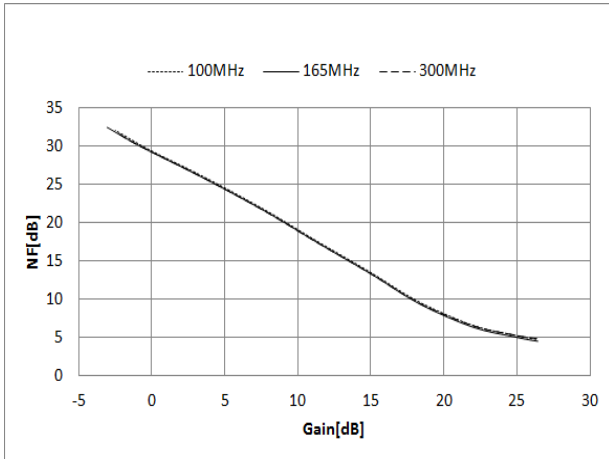

Fig.5-1 NF VS Gain (Temp =25°C)

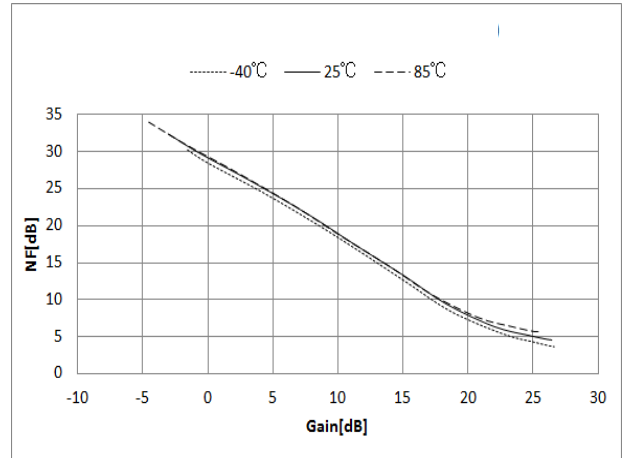

Fig.5-2 NF VS Gain (fo=165MHz)

3. IMD3

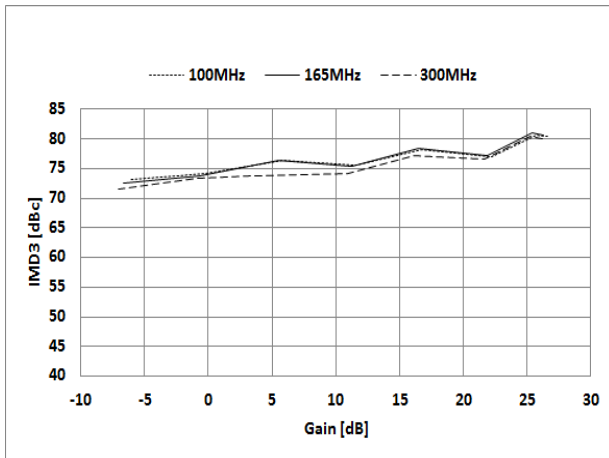

Fig.6-1 IMD3 VS Gain (Temp =25°C)

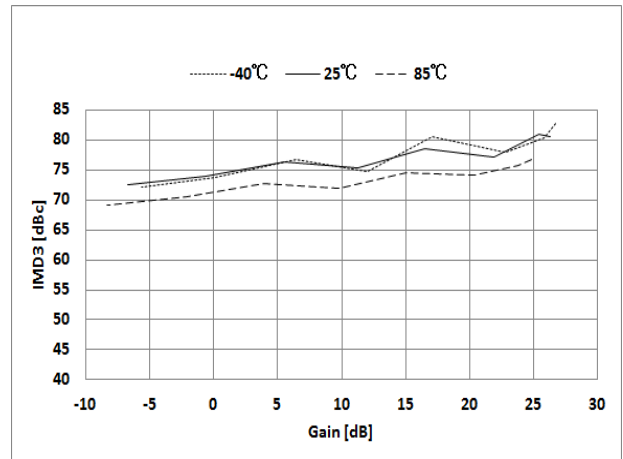
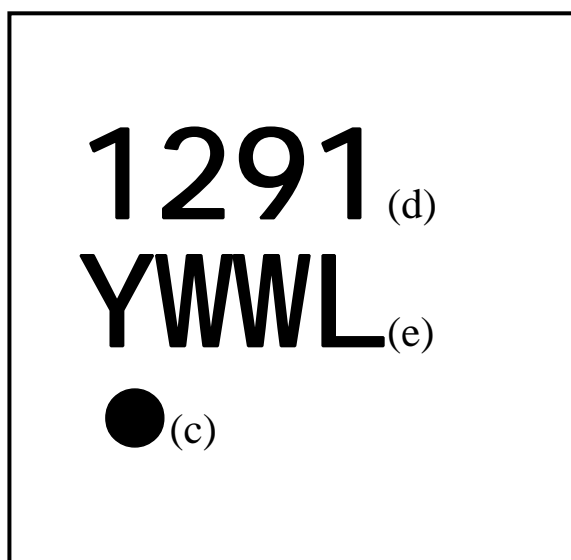

Fig.6-2 IMD3 VS Gain (fo=165MHz)

13. Marking

- (a) Style : QFN
(b) Number of pins : 24
(c) 1 pin marking: ○
(d) Product number : 1291
(e) Date code : YWWL (4 digits)
- Y: Lower 1 digit of calendar year (Year 2013 → 3, 2014 → 4 ...)
WW: Week
L: Lot identification, given to each product lot which is made in a week
- LOT ID is given in alphabetical order (A, B, C...).



14. Outer Dimensions

HWQFN24-4×4-0.5

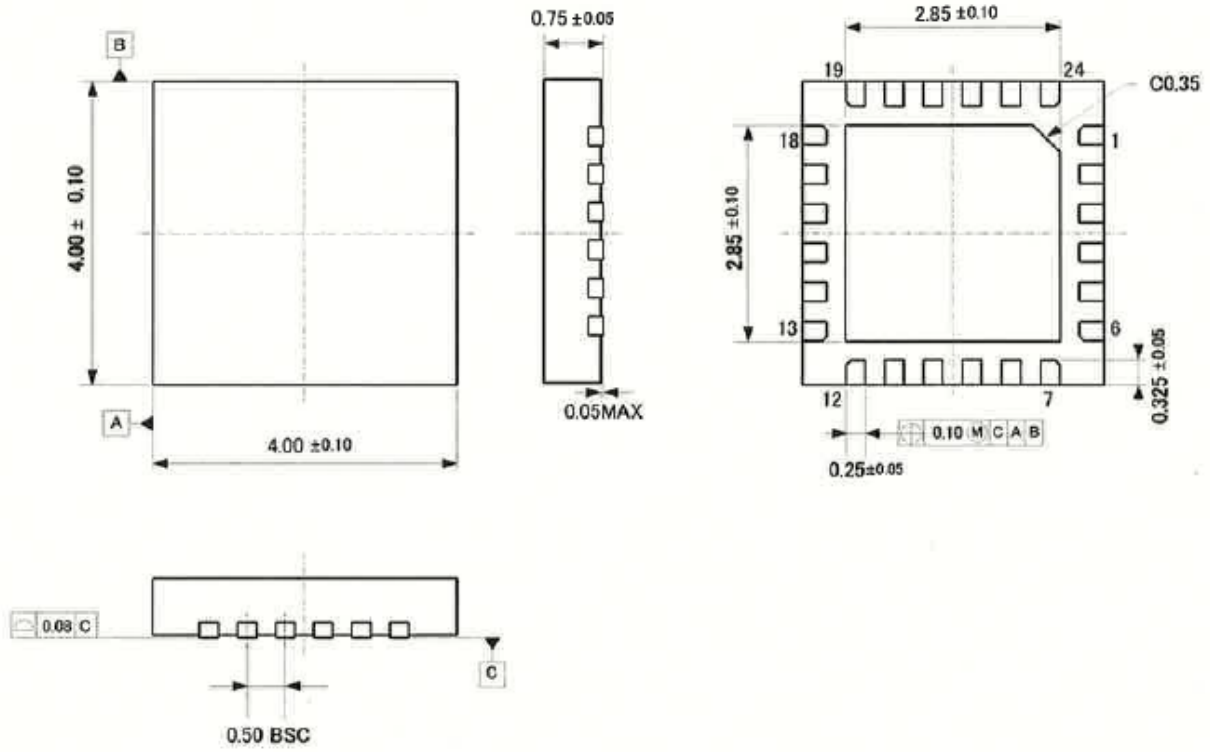

Note) the exposed pad at the center of the backside should be connected to ground.

IMPORTANT NOTICE

- Descriptions of external circuits, application circuits, software and other related information contained in this document are provided only to illustrate the operation and application examples of the semiconductor products. You are fully responsible for the incorporation of these external circuits, application circuits, software and other related information in the design of your equipments. Asahi Kasei Microdevices Corporation (AKM) assumes no responsibility for any losses incurred by you or third parties arising from the use of these information herein. AKM assumes no liability for infringement of any patent, intellectual property, or other rights in the application or use of such information contained herein.
- Any export of these products, or devices or systems containing them, may require an export license or other official approval under the law and regulations of the country of export pertaining to customs and tariffs, currency exchange, or strategic materials.
- AKM products are neither intended nor authorized for use as critical components^{Note1)} in any safety, life support, or other hazard related device or system^{Note2)}, and AKM assumes no responsibility for such use, except for the use approved with the express written consent by Representative Director of AKM. As used here:
 - Note1) A critical component is one whose failure to function or perform may reasonably be expected to result, whether directly or indirectly, in the loss of the safety or effectiveness of the device or system containing it, and which must therefore meet very high standards of performance and reliability.
 - Note2) A hazard related device or system is one designed or intended for life support or maintenance of safety or for applications in medicine, aerospace, nuclear energy, or other fields, in which its failure to function or perform may reasonably be expected to result in loss of life or in significant injury or damage to person or property.
- It is the responsibility of the buyer or distributor of AKM products, who distributes, disposes of, or otherwise places the product with a third party, to notify such third party in advance of the above content and conditions, and the buyer or distributor agrees to assume any and all responsibility and liability for and hold AKM harmless from any and all claims arising from the use of said product in the absence of such notification.