

## Description

The AL8841Q is a hysteresis mode DC-DC step-down converter, designed for driving single or multiple series connected LEDs efficiently from a voltage source higher than the LED voltage. The device can operate from an input supply between 4.5V and 40V and provide an externally adjustable output current up to 1A for TSOT25 and 1.5A for MSOP-8EP package. Depending upon supply voltage and external components, this converter can provide up to 60W of output power.

The AL8841Q integrates the power switch and a high-side output current sensing circuit, which uses an external resistor to set the nominal average output current.

Dimming can be realized by applying an external control signal to the CTRL pin. The CTRL pin will accept either a DC voltage signal or a PWM signal.

The soft-start time can be adjusted by an external capacitor from the CTRL pin to Ground. Applying a voltage of 0.3V or lower to the CTRL pin will shut down the power switch.

The AL8841Q is available in the thermally enhanced MSOP-8EP package and the small footprint TSOT25 package.

## Features

- AEC-Q100 (Grade 1) Qualification
- Wide Input Voltage Range: 4.5V to 40V
- Output Current up to 1A for TSOT25 and 1.5A for MSOP-8EP
- Internal 40V NDMOS Switch
- Typical 4% Output Current Accuracy
- Single Pin for On/Off and Brightness Control by DC Voltage or PWM Signal
- Recommended Analog Dimming Range: 10% to 100%
- Soft-Start
- High Efficiency (Up to 97%)
- LED Short Protection
- Inherent Open-Circuit LED Protection
- Overtemperature Protection (OTP)
- Up to 1MHz Switching Frequency
- MSOP-8EP & TSOT25 Packages Available in Green Molding Compound (No Br, Sb)
- **Totally Lead-Free & Fully RoHS Compliant (Notes 1 & 2)**
- **Halogen and Antimony Free. "Green" Device (Note 3)**
- **The AL8841Q is suitable for automotive applications requiring specific change control; this part is AEC-Q100 qualified, PPAP capable, and manufactured in IATF16949 certified facilities.**

<https://www.diodes.com/quality/product-definitions/>

- Notes:
1. No purposely added lead. Fully EU Directive 2002/95/EC (RoHS), 2011/65/EU (RoHS 2) & 2015/863/EU (RoHS 3) compliant.
  2. See <https://www.diodes.com/quality/lead-free/> for more information about Diodes Incorporated's definitions of Halogen- and Antimony-free, "Green" and Lead-free.
  3. Halogen- and Antimony-free "Green" products are defined as those which contain <900ppm bromine, <900ppm chlorine (<1500ppm total Br + Cl) and <1000ppm antimony compounds.

## Pin Assignments

(Top View)

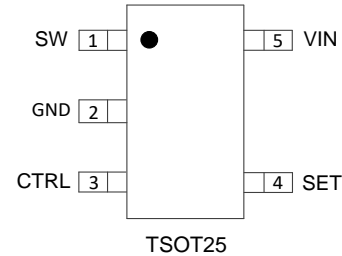

(Top View)

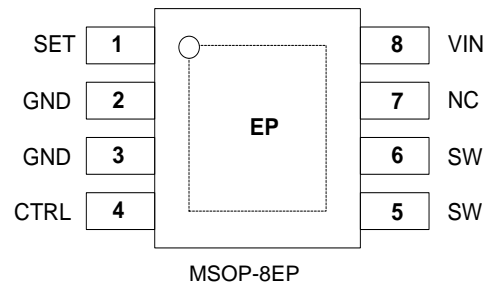

## Applications

- Automotive daytime running lights
- Automotive front and rear fog lights
- Automotive turn/stop lights
- Automotive dimmable interior lights

**Typical Applications Circuit**

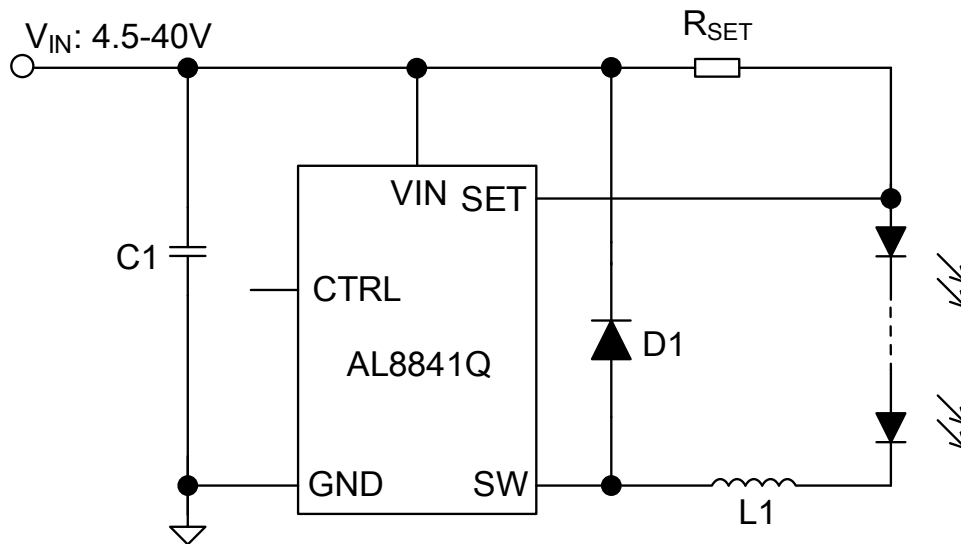

**Pin Descriptions**

Pin Number		Pin Name	Function
TSOT25	MSOP-8EP		
2	2, 3	GND	Ground of IC
4	1	SET	Set Nominal Output Current Pin. Connect resistor R <sub>SET</sub> from this pin to VIN to define nominal average output current.
—	7	NC	No Connection
3	4	CTRL	Multi-function On/Off and brightness control pin: <ul style="list-style-type: none"> <li>• Leave floating for normal operation.</li> <li>• Drive to voltage below 0.3V to turn off output current.</li> <li>• Drive with DC voltage (0.4V &lt; CTRL &lt; 2.5V) to adjust output current from 10% to 100% of I<sub>OUT_NOM</sub>.</li> <li>• Drive with an analog voltage &gt; 2.6V output current will be 100% of I<sub>OUT_NOM</sub>.</li> <li>• A PWM signal (Low level &lt; 0.3V, High level &gt; 2.6V, transition times less than 1μs) allows the output current to be adjusted over a wide range up to 100%.</li> <li>• Connect a capacitor from this pin to ground to increase soft-start time. (Default soft-start time = 0.1ms. Additional soft-start time is approximately 1.5ms/1nF)</li> </ul>
5	8	VIN	Input voltage (4.5V to 40V). Decouple to ground with 10μF or higher X7R ceramic capacitor close to device.
1	5, 6	SW	Switch Pin. Connect inductor/freewheeling diode here, minimizing track length at this pin to reduce EMI.
—	EP	EP	Exposed pad/TAB connects to GND and thermal mass for enhanced thermal impedance.

**Functional Block Diagram**

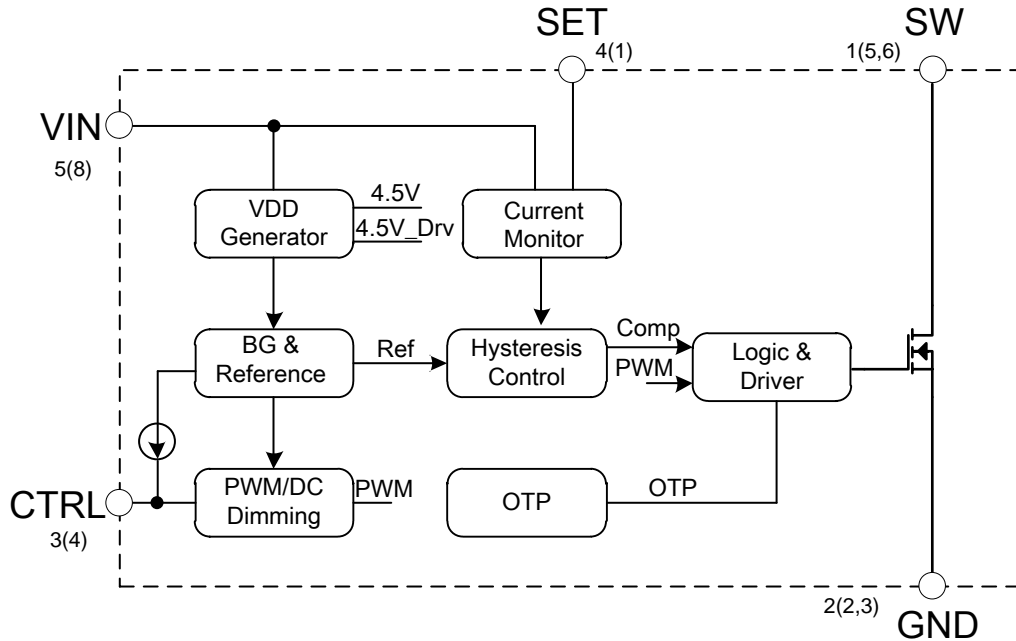

**Absolute Maximum Ratings** (Note 4)

Symbol	Parameter	Rating	Unit
V <sub>IN</sub>	Input Voltage	-0.3 to +42	V
V <sub>SW</sub> , V <sub>SET</sub>	SW, SET Pin Voltage	-0.3 to +42	V
V <sub>CTRL</sub>	CTRL Pin Input Voltage	-0.3 to +6	V
T <sub>J</sub>	Operating Junction Temperature	-40 to +150	°C
T <sub>STG</sub>	Storage Temperature Range	-65 to +150	°C
T <sub>LEAD</sub>	Lead Temperature (Soldering, 10sec)	+300	°C

Note: 4. Stresses greater than those listed under *Absolute Maximum Ratings* can cause permanent damage to the device. These are stress ratings only, and functional operation of the device at these or any other conditions beyond those indicated under *Recommended Operating Conditions* is not implied. Exposure to *Absolute Maximum Ratings* for extended periods can affect device reliability. Besides, if the voltage on SET pin is higher than 5V, the device will enter the test mode for parameter test. Therefore, the voltage on SET pin should be kept below 5V for normal operation.

**ESD Ratings**

Symbol	Parameter	Rating	Unit
V <sub>ESD</sub>	Human Body Model (HBM), per AEC Q100-002 (Note 5)	3000	V
	Charged Device Model (CDM), per AEC Q100-011	1000	

**Thermal Information**

Symbol	Parameter	Rating	Unit
θ <sub>JA</sub>	Junction-to-Ambient Thermal Resistance	TSOT25 (Note 5)	147
		MSOP-8EP (Note 6)	56
θ <sub>JC</sub>	Junction-to-Case (Top) Thermal Resistance	TSOT25 (Note 5)	27
		MSOP-8EP (Note 6)	15

Notes: 5. Device mounted on 1" x 1" FR-4 MRP substrate PC board, 2oz cooper, with minimum recommended pad layout.  
6. Device mounted on 2" x 2" FR-4 substrate PCB, 2oz copper, with minimum recommended pad layout.

### Recommended Operating Conditions

Symbol	Parameter	Min	Max	Unit
V <sub>IN</sub>	Input Voltage	4.5	40	V
f <sub>SW</sub>	Switching Frequency	—	1	MHz
I <sub>OUT</sub>	Continuous Output Current	—	1.5	A
V <sub>CTRL</sub>	Voltage Range for 10% to 100% DC Dimming Relative to GND	0.4	2.5	V
V <sub>CTRL_HIGH</sub>	Voltage High for PWM Dimming Relative to GND	2.6	5	V
V <sub>CTRL_LOW</sub>	Voltage Low for PWM Dimming Relative to GND	0	0.3	V
T <sub>A</sub>	Operating Ambient Temperature	-40	+125	°C

### Electrical Characteristics (@V<sub>IN</sub> = 16V, T<sub>A</sub> = -40°C to +125°C, unless otherwise specified.)

Symbol	Parameter	Condition	Min	Typ	Max	Unit
<b>SUPPLY VOLTAGE</b>						
V <sub>IN</sub>	Input Voltage	—	4.5	—	40	V
I <sub>Q</sub>	Quiescent Current	CTRL Pin Floating, V <sub>IN</sub> = 16V	—	0.35	—	mA
V <sub>UVLO</sub>	Undervoltage Lockout	V <sub>IN</sub> Rising	—	3.9	—	V
V <sub>UVLO_HYS</sub>	UVLO Hysteresis	—	—	250	—	mV
<b>HYSTERESTIC CONTROL</b>						
V <sub>SET</sub>	Mean Current Sense Threshold Voltage	Measured on SET Pin with Respect to V <sub>IN</sub> @+25°C	96	100	104	mV
		Measured on SET Pin with Respect to V <sub>IN</sub> @-40°C to +125°C	95	100	105	mV
V <sub>SET_HYS</sub>	Sense Threshold Hysteresis	—	—	±13	—	%
I <sub>SET</sub>	SET Pin Input Current	V <sub>SET</sub> = V <sub>IN</sub> - 0.1V	—	8	—	µA
<b>ENABLE AND DIMMING</b>						
V <sub>CTRL</sub>	Voltage Range on CTRL Pin	For Analog Dimming	0.4	—	2.5	V
—	Analog Dimming Range	—	10	—	100	%
V <sub>CTRL_ON</sub>	DC Voltage on CTRL Pin for Analog Dimming On	V <sub>CTRL</sub> Rising	—	0.45	—	V
V <sub>CTRL_OFF</sub>	DC Voltage on CTRL Pin for Analog Dimming Off	V <sub>CTRL</sub> Falling	—	0.40	—	V
<b>SWITCHING OPERATION</b>						
R <sub>ON</sub>	SW Switch On Resistance	@I <sub>SW</sub> = 100mA	—	0.2	—	Ω
I <sub>SW_LEAK</sub>	SW Switch Leakage Current	—	—	—	8	µA
t <sub>SS</sub>	Soft-Start Time	V <sub>IN</sub> = 16V, C <sub>CTRL</sub> = 1nF	—	1.5	—	ms
f <sub>SW</sub>	Operating Frequency	V <sub>IN</sub> = 16V, V <sub>O</sub> = 9.6V (3 LEDs) L = 47µH, ΔI = 0.25A (I <sub>LED</sub> = 1A)	—	250	—	kHz
f <sub>SW_MAX</sub>	Recommended Maximum Switch Frequency	—	—	—	1	MHz
t <sub>ON_REC</sub>	Recommended Minimum Switch ON Time	For 4% Accuracy	—	500	—	ns
t <sub>PD</sub>	Internal Comparator Propagation Delay (Note 7)	—	—	100	—	ns
<b>THERMAL SHUTDOWN</b>						
T <sub>OTP</sub>	Overtemperature Protection	—	—	+150	—	°C
T <sub>OTP_HYS</sub>	Temp Protection Hysteresis	—	—	+30	—	°C

Note: 7. Guaranteed by design.

**Typical Performance Characteristics** (@ $T_A = +25^\circ\text{C}$ ,  $V_{IN} = 16\text{V}$ , unless otherwise specified.)

**Quiescent Current vs. Input Voltage**

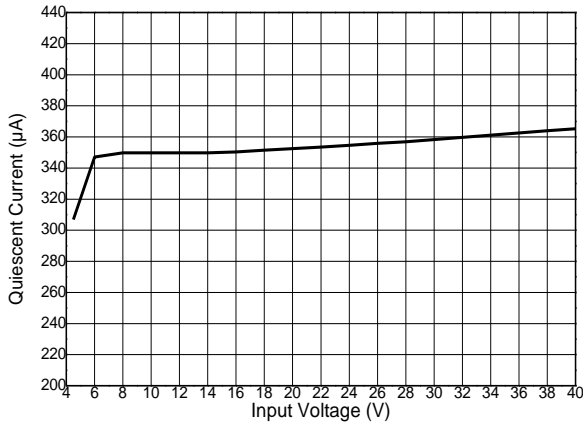

**Quiescent Current vs. Temperature**

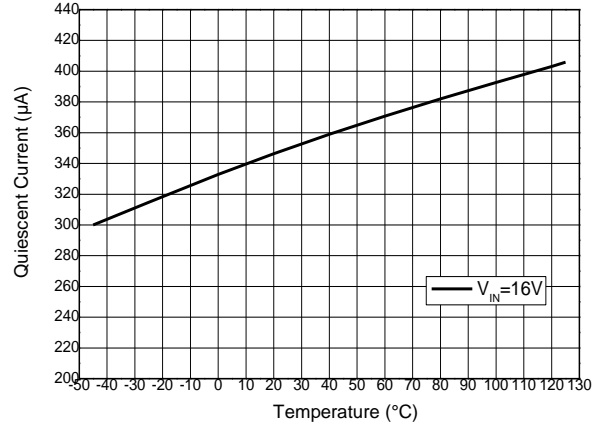

**SET Threshold Voltage vs. Input Voltage**

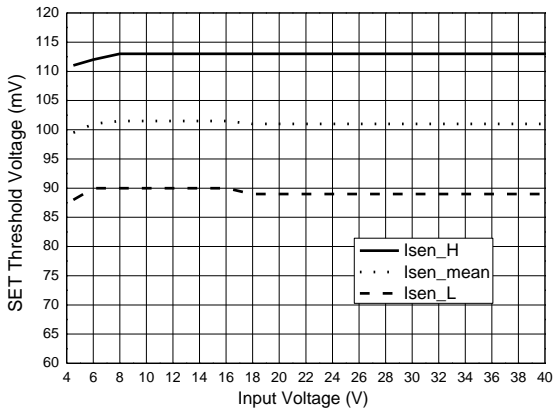

**SET Threshold Voltage vs. Temperature**

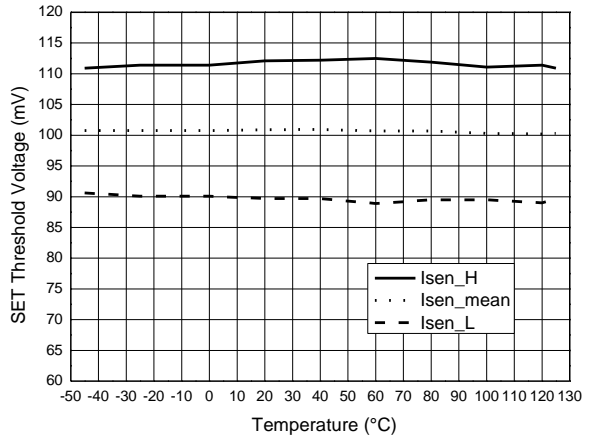

**PWM Dimming ( $V_{IN} = 16\text{V}$ , 3 LEDs,  $47\mu\text{H}$ ,  $R_{SET} = 0.3\Omega$ )  
LED Current vs. PWM Duty Cycle**

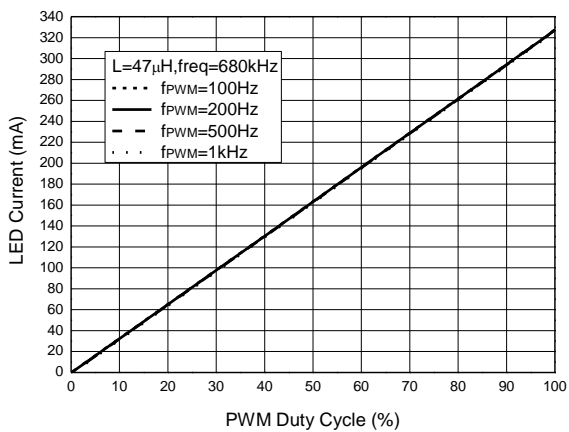

**Analog Dimming ( $V_{IN} = 16\text{V}$ , 3 LEDs,  $47\mu\text{H}$ ,  $R_{SET} = 0.3\Omega$ )  
LED Current vs. CTRL Pin Voltage**

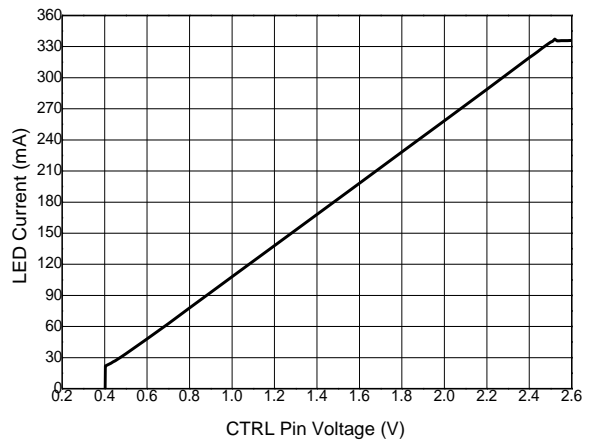

**Typical Performance Characteristics** (continued) (@T<sub>A</sub> = +25°C, V<sub>IN</sub> = 16V, unless otherwise specified.)

**Efficiency vs. Input Voltage**  
(R<sub>SET</sub> = 0.3Ω, L = 100μH)

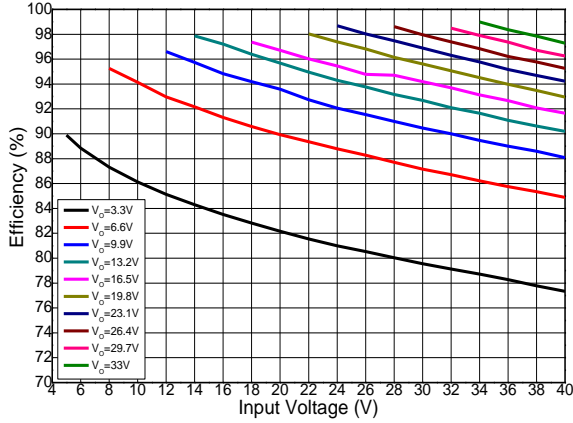

**Efficiency vs. Input Voltage**  
(R<sub>SET</sub> = 0.15Ω, L = 47μH)

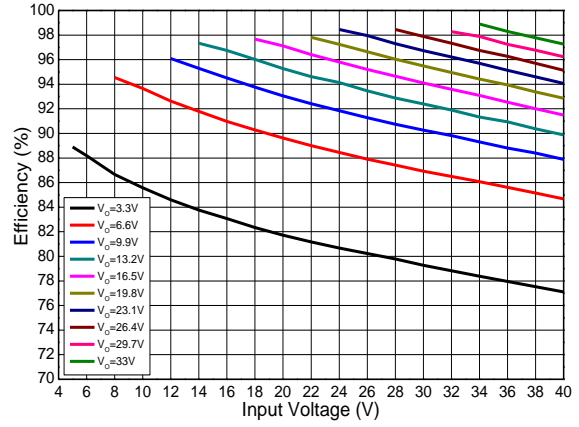

**Efficiency vs. Input Voltage**  
(R<sub>SET</sub> = 0.1Ω, L = 33μH)

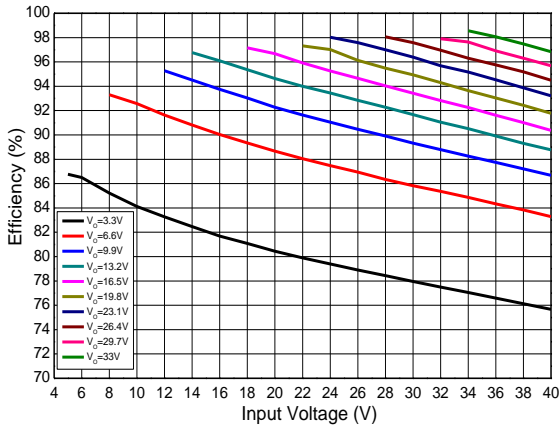

**Efficiency vs. Input Voltage**  
(R<sub>SET</sub> = 0.067Ω, L = 47μH)

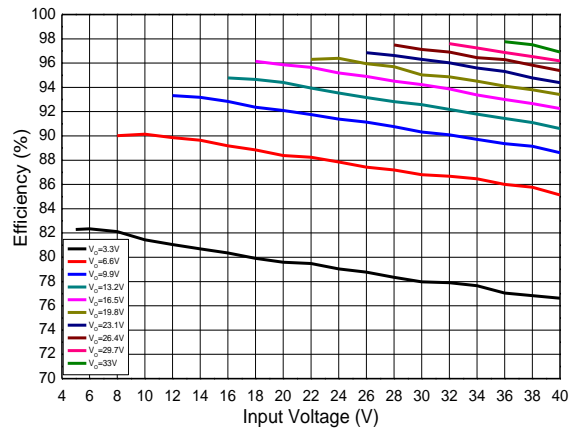

**Efficiency vs. Input Voltage**  
(R<sub>SET</sub> = 0.05Ω, L = 47μH)

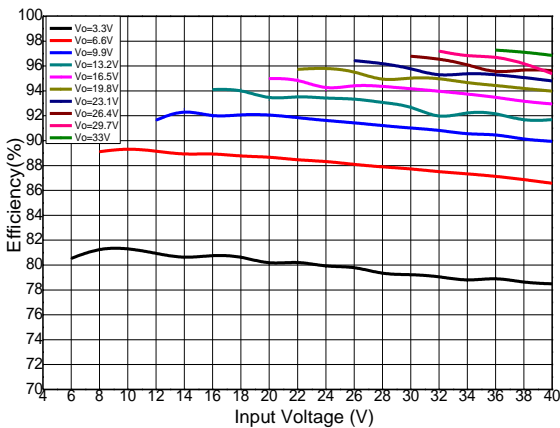

**LED Current vs. Input Voltage**  
(R<sub>SET</sub> = 0.3Ω, L = 100μH)

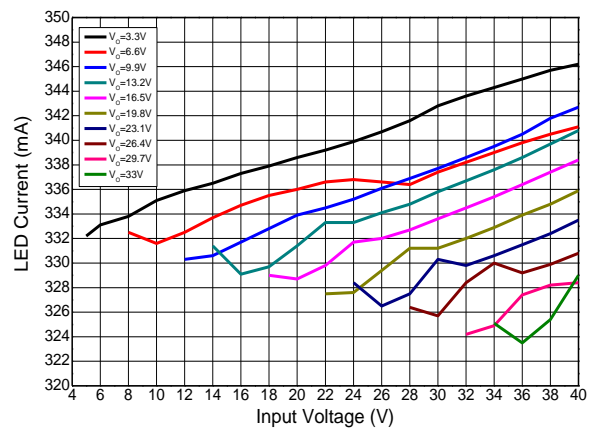

**Typical Performance Characteristics** (continued) (@ $T_A = +25^\circ\text{C}$ ,  $V_{IN} = 16\text{V}$ , unless otherwise specified.)

**LED Current vs. Input Voltage**  
( $R_{SET} = 0.15\Omega$ ,  $L = 47\mu\text{H}$ )

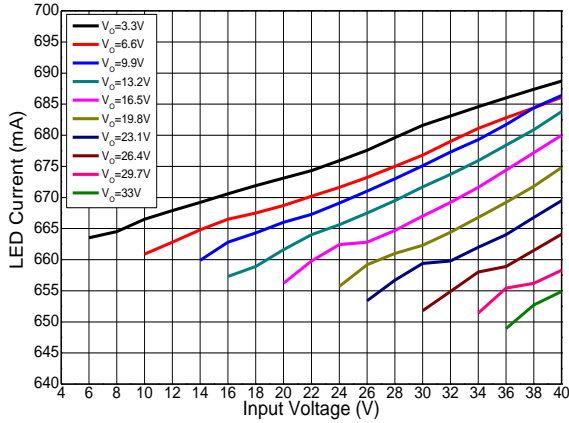

**LED Current vs. Input Voltage**  
( $R_{SET} = 0.1\Omega$ ,  $L = 33\mu\text{H}$ )

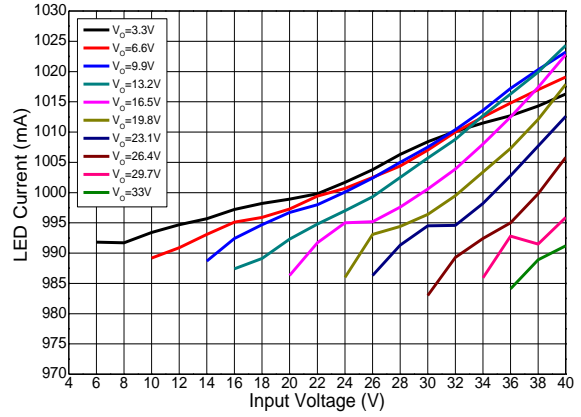

**LED Current vs. Input Voltage**  
( $R_{SET} = 0.067\Omega$ ,  $L = 47\mu\text{H}$ )

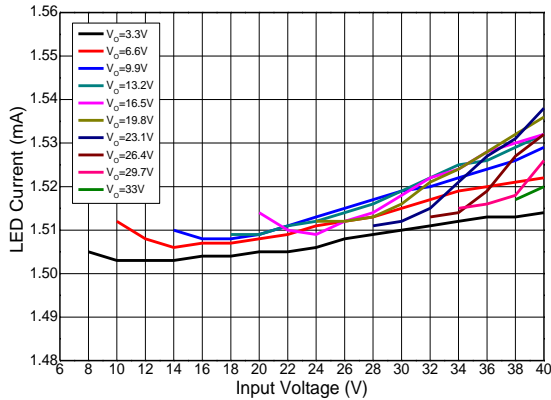

**LED Current vs. Input Voltage**  
( $R_{SET} = 0.05\Omega$ ,  $L = 47\mu\text{H}$ )

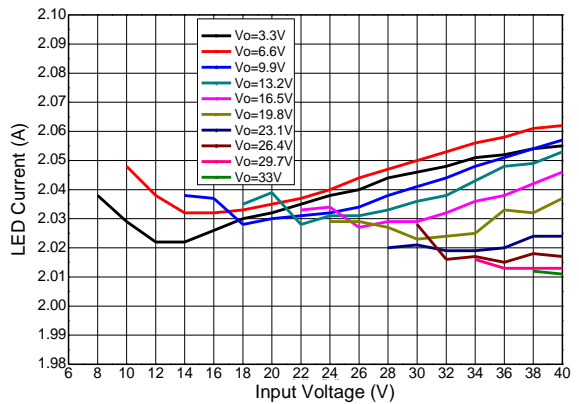

**Operating Frequency vs. Input Voltage**  
( $R_{SET} = 0.3\Omega$ ,  $L = 100\mu\text{H}$ )

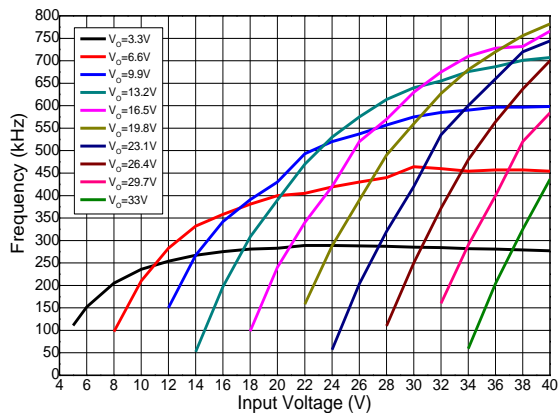

**Operating Frequency vs. Input Voltage**  
( $R_{SET} = 0.15\Omega$ ,  $L = 47\mu\text{H}$ )

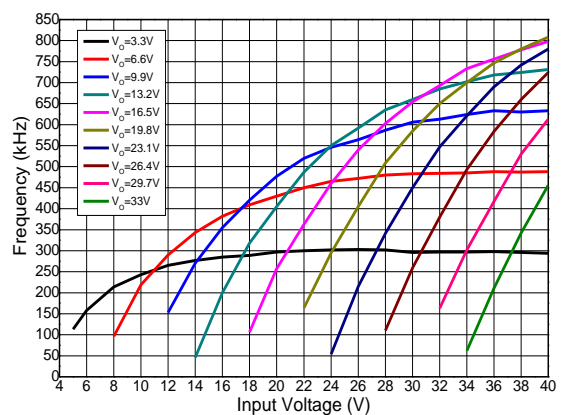

**Typical Performance Characteristics** (continued) (@T<sub>A</sub> = +25°C, V<sub>IN</sub> = 16V, unless otherwise specified.)

**Operating Frequency vs. Input Voltage**  
(R<sub>SET</sub> = 0.1Ω, L = 33μH)

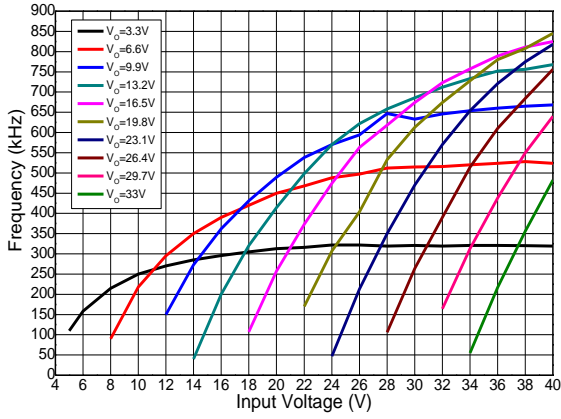

**Operating Frequency vs. Input Voltage**  
(R<sub>SET</sub> = 0.067Ω, L = 47μH)

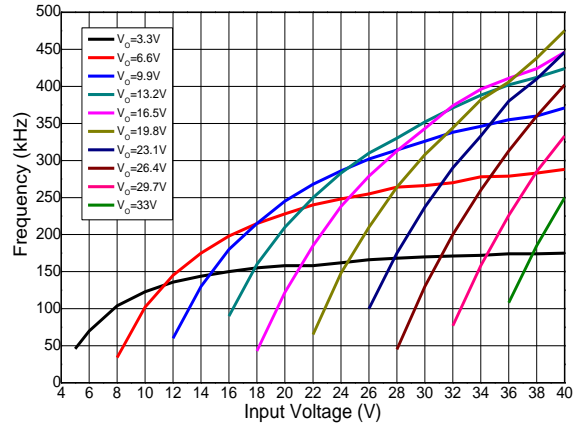

**Operating Frequency vs. Input Voltage**  
(R<sub>SET</sub> = 0.05Ω, L = 47μH)

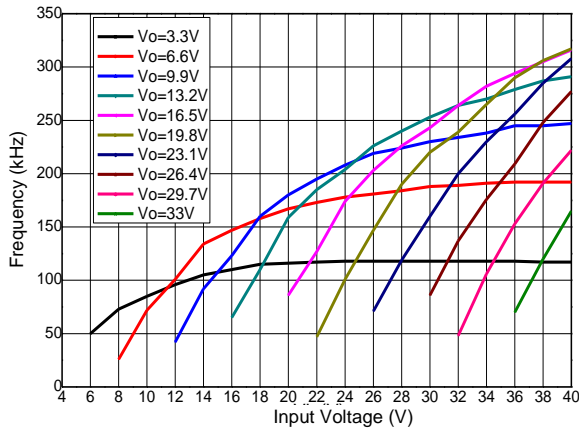

**LED Current vs. Output Voltage**  
(R<sub>SET</sub> = 0.3Ω, L = 100μH)

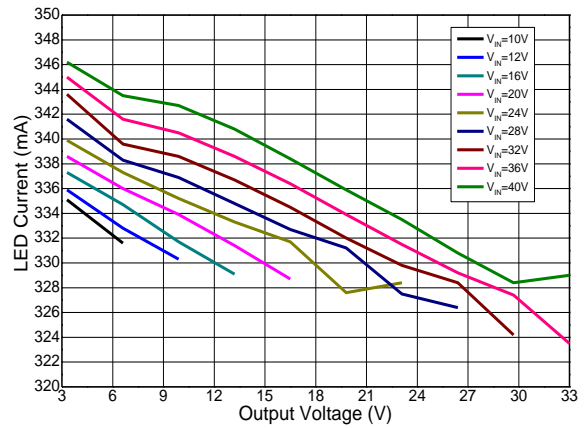

**LED Current vs. Output Voltage**  
(R<sub>SET</sub> = 0.15Ω, L = 47μH)

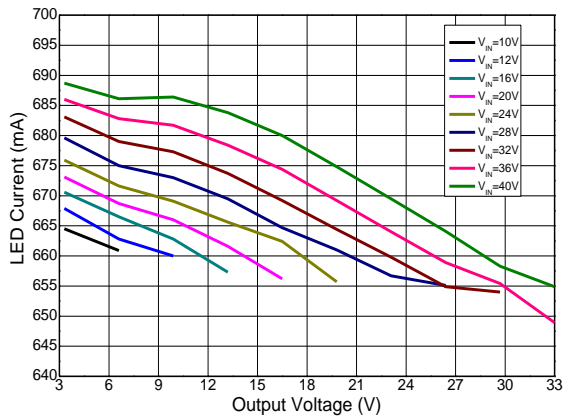

**LED Current vs. Output Voltage**  
(R<sub>SET</sub> = 0.1Ω, L = 33μH)

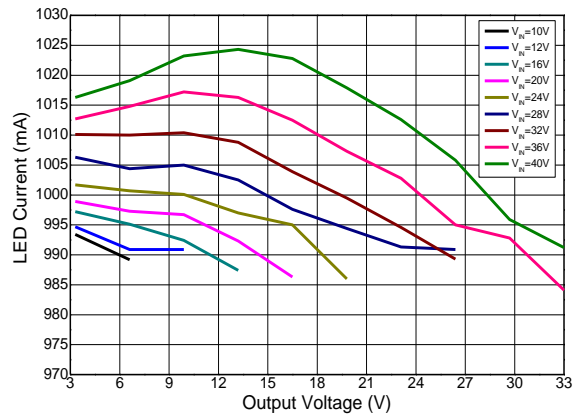



**Typical Performance Characteristics** (continued) (@ $T_A = +25^\circ\text{C}$ ,  $V_{IN} = 16\text{V}$ , unless otherwise specified.)

**LED Current vs. Output Voltage**  
( $R_{SET} = 0.067\Omega$ ,  $L = 47\mu\text{H}$ )

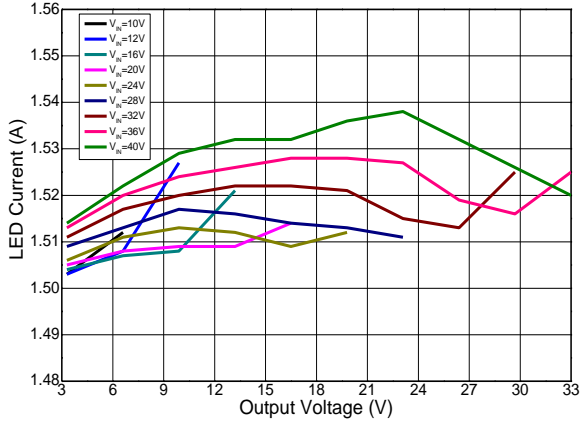

**LED Current vs. Output Voltage**  
( $R_{SET} = 0.05\Omega$ ,  $L = 47\mu\text{H}$ )

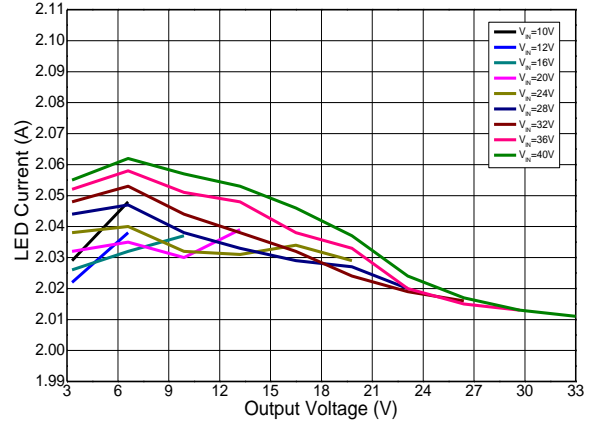

**Performance Characteristics** (@ $V_{IN} = 16\text{V}$ , 3 LEDs,  $R_{SET} = 0.3\Omega$ ,  $L = 47\mu\text{H}$ ,  $T_A = +25^\circ\text{C}$ , unless otherwise specified.)

**Steady State**

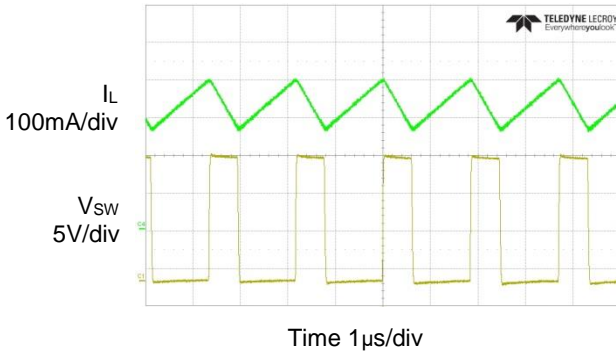

**Startup Delay Time**

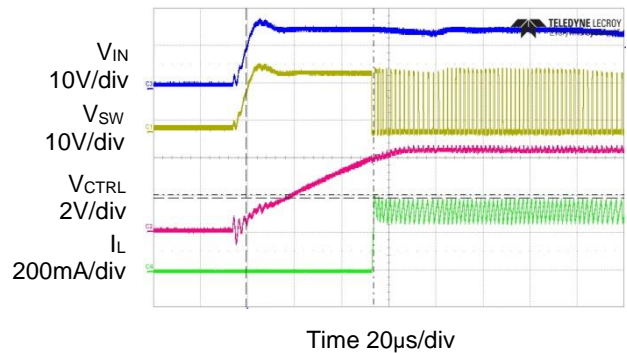

**PWM Dimming (100Hz, Duty = 50%)**

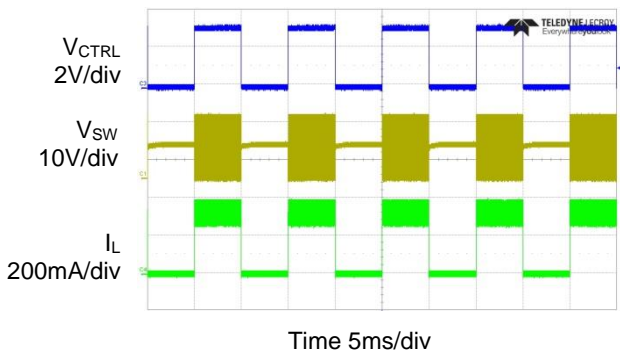

**LED Open Protection**

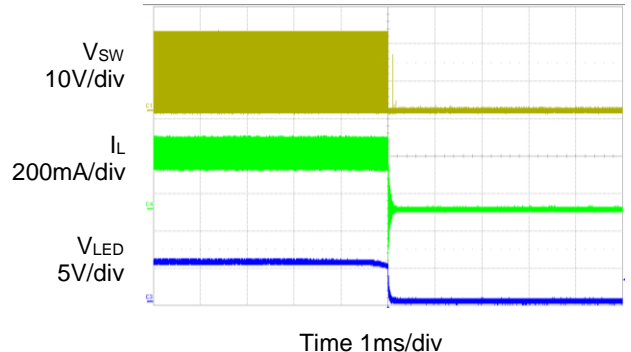

## Application Information

### AL8841Q Operation

In normal operation, when normal input voltage is applied at +V<sub>IN</sub>, the AL8841Q internal switch will turn on. Current starts to flow through sense resistor R<sub>SET</sub>, inductor L1, and the LEDs. The current ramps up linearly, and the ramp-up rate is determined by the input voltage V<sub>IN</sub>, V<sub>OUT</sub> and the inductor L1.

This rising current produces a voltage ramp across R<sub>SET</sub>. The internal circuit of the AL8841Q senses the voltage across R<sub>SET</sub> and applies a proportional voltage to the input of the internal comparator. When this voltage reaches an internally set upper threshold, the internal switch is turned off. The inductor current continues to flow through R<sub>SET</sub>, L1, LEDs and diode D1, and back to the supply rail, but it decays, with the rate determined by the forward voltage drop of LEDs and the diode D1.

This decaying current produces a falling voltage on R<sub>SET</sub>, which is sensed by the AL8841Q. A voltage proportional to the sense voltage across R<sub>SET</sub> will be applied at the input of internal comparator. When this voltage falls to the internally set lower threshold, the internal switch is turned on again. This switch-on-and-off cycle continues to provide the average LED current set by the sense resistor R<sub>SET</sub>.

### LED Current Configuration

The nominal average output current in the LED(s) is determined by the value of the external current sense resistor (R<sub>SET</sub>) connected between V<sub>IN</sub> and SET and is given by:

$$I_{OUT(NOM)} = \frac{0.1}{R_{SET}}$$

The table below gives values of nominal average output current for several preferred values of current setting resistor (R<sub>SET</sub>) in the *Typical Applications Circuit* shown on Page 2.

R <sub>SET</sub> (Ω)	Nominal Average Output Current (mA)
0.067	1,500
0.1	1,000
0.15	667
0.3	333

The above values assume that the CTRL pin is floating and at a nominal reference voltage for internal comparator. It is possible to use different values of R<sub>SET</sub> if the CTRL pin is driven by an external dimming signal.

### Analog Dimming

Applying a DC voltage from 0.4V to 2.5V on the CTRL pin can adjust output current from 10% to 100% of I<sub>OUT\_NOM</sub>, as shown in Figure 1. If the CTRL pin is brought higher than 2.5V, the LED current will be clamped to 100% of I<sub>OUT\_NOM</sub> while if the CTRL voltage falls below the threshold of 0.3V, the output switch will turn off.

### PWM Dimming

LED current can be adjusted digitally, by applying a low frequency pulse-width-modulated (PWM) logic signal to the CTRL pin to turn the device on and off. This will produce an average output current proportional to the duty cycle of the control signal. To achieve a high resolution, the PWM frequency is recommended to be lower than 500Hz, however higher dimming frequencies can be used at the expense of dimming dynamic range and accuracy. Typically, for a PWM frequency of 500Hz the accuracy is better than 1% for PWM ranging from 1% to 100%.

The accuracy of the low duty cycle dimming is affected by both the PWM frequency and the switching frequency of the AL8841Q. For best accuracy/resolution, the switching frequency should be increased while the PWM frequency should be reduced.

The CTRL pin is designed to be driven by both 3.3V logic levels directly from a logic output with either an open-drain output or push-pull output stage.

**Application Information** (continued)

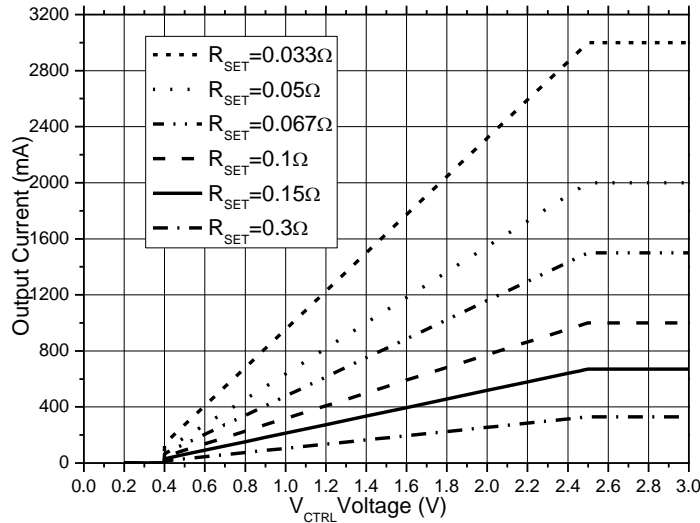

Figure 1. Analog Dimming Curve

**Soft-Start**

The default soft-start time for AL8841Q is only 0.1ms – this provides very fast turn-on of the output, improving PWM dimming accuracy.

Nevertheless, adding an external capacitor from the CTRL pin to Ground will provide a longer soft-start delay. This is achieved by increasing the time for the CTRL voltage rising to the turn-on threshold, and by slowing down the rising rate of the control voltage at the input of hysteresis comparator. The additional soft-start time is related to the capacitance between CTRL and GND, the typical value will be 1.5ms/nF.

**Capacitor Selection**

A low ESR capacitor should be used for input decoupling, as the ESR of this capacitor appears in series with the supply source impedance and will lower overall efficiency. This capacitor has to supply the relatively high peak current to the coil and smooth the ripple on the input current.

The minimum capacitance needed is determined by input power, cable's length and peak current. 4.7μF to 10μF is a commonly used value for most cases. A higher value will improve performance at lower input voltages, especially when the source impedance is high. The input capacitor should be placed as close as possible to the IC.

For maximum stability of overtemperature and voltage, capacitors with X7R, X5R or better dielectric are recommended. Capacitors with Y5V dielectric are not suitable for decoupling in this application and should NOT be used.

**Diode Selection**

For maximum efficiency and performance, the freewheeling diode (D1) should be a fast low capacitance Schottky diode with low reverse leakage current. It also provides better efficiency than silicon diodes, due to lower forward voltage and reduced recovery time.

It is important to select parts with a peak current rating above the peak coil current, and a continuous current rating higher than the maximum output load current. It is very important to consider the reverse leakage current of the diode when operating above +85°C. Excess leakage current will increase power dissipation.

The higher forward voltage and overshoot due to reverse recovery time in silicon diodes will increase the peak voltage on the SW output. If a silicon diode is used, more care should be taken to ensure that the total voltage appearing on the SW pin including supply ripple, will not exceed the specified maximum value.

---

## Application Information (continued)

---

### Inductor Selection

Recommended inductor values for the AL8841Q are in the range 33μH to 100μH. Higher inductance are recommended at higher supply voltages in order to minimize output current tolerance due to switching delays, which will result in increased ripple and lower efficiency. Higher inductance also results in a better line regulation. The inductor should be mounted as close to the device as possible with low resistance connections to SW pins.

The chosen coil should have saturation current higher than the peak output current and a continuous current rating above the required mean output current.

The inductor value should be chosen to maintain operating duty cycle and switch 'on'/'off' times within the specified limits over the supply voltage and load current range. The following equations can be used as a guide.

SW Switch 'On' Time

$$t_{ON} = \frac{L\Delta I}{V_{IN} - V_{LED} - I_{LED}(R_{SET} + R_L + R_{SW})}$$

SW Switch 'Off' Time

$$t_{OFF} = \frac{L\Delta I}{V_{LED} + V_D + I_{LED}(R_{SET} + R_L)}$$

Where: L is the coil inductance; R<sub>L</sub> is the coil resistance; R<sub>SET</sub> is the current sense resistance; I<sub>LED</sub> is the required LED current; ΔI is the coil peak-peak ripple current (internally set to 0.26 × I<sub>LED</sub>); V<sub>IN</sub> is the supply voltage; V<sub>LED</sub> is the total LED forward voltage; R<sub>SW</sub> is the switch resistance (0.2Ω nominal); V<sub>D</sub> is the diode forward voltage at the required load current.

### Thermal Protection

The AL8841Q includes Overtemperature Protection (OTP) circuitry that will turn off the device if its junction temperature gets too high. This is to protect the device from excessive heat damage. The OTP circuitry includes thermal hysteresis that will cause the device to restart normal operation once its junction temperature has cooled down by approximately +30°C.

### Open Circuit LEDs

The AL8841Q has by default open LED protection. If the LEDs should become open circuit the AL8841Q will stop oscillating; the SET pin will rise to V<sub>IN</sub> and the SW pin will then fall to GND. No excessive voltages will be seen by the AL8841Q.

### LED Chain Shorted Together

If the LED chain should become shorted together (the anode of the top LED becomes shorted to the cathode of the bottom LED) the AL8841Q will continue to switch and the current through the AL8841Q's internal switch will still be at the expected current - so no excessive heat will be generated within the AL8841Q. However, the duty cycle at which it operates will change dramatically and the switching frequency will most likely decrease. See Figure 2 for an example of this behavior at 24V input voltage driving 3 LEDs.

The on-time of the internal power MOSFET switch is significantly reduced because almost all of the input voltage is now developed across the inductor. The off-time is significantly increased because the reverse voltage across the inductor is now just the Schottky diode voltage (See Figure 2) causing a much slower decay in inductor current.

**Application Information** (continued)

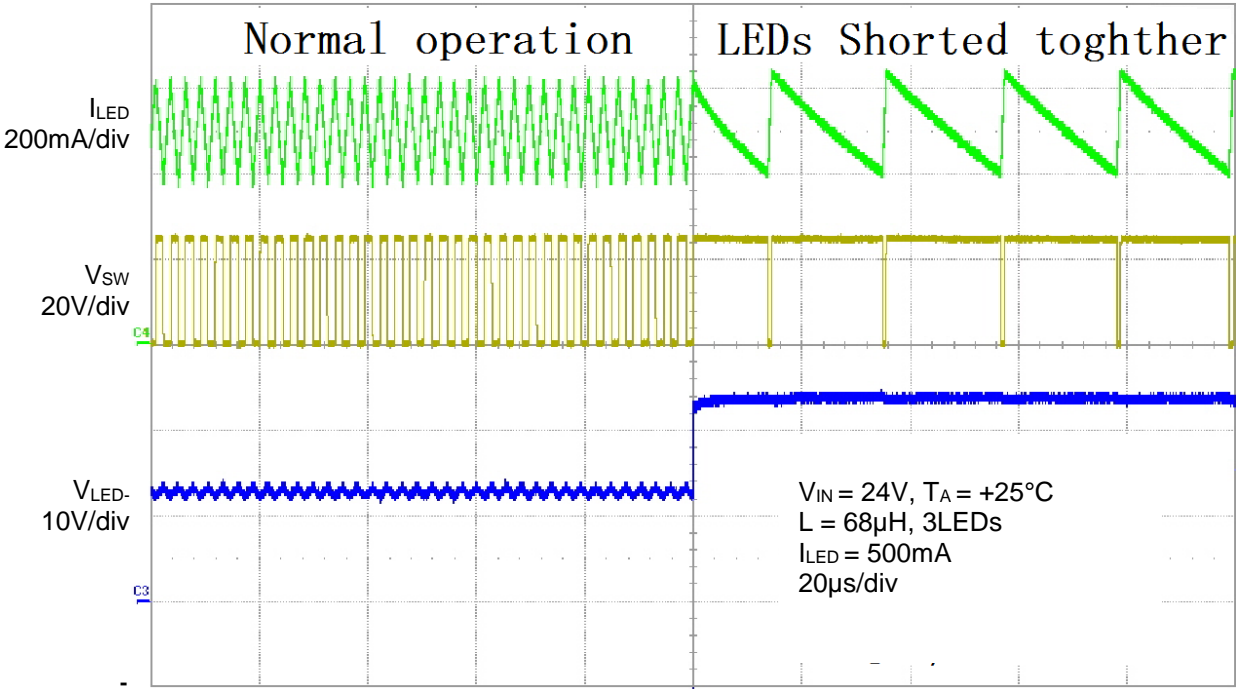
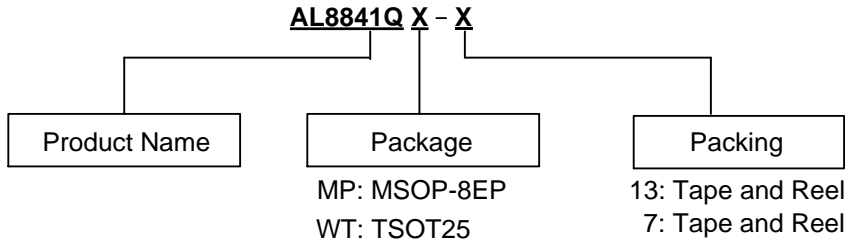

Figure 2. Switching Characteristics (Normal Operation to LED Chain Shorted Out)

**Design Tools** (<https://www.diodes.com/design/tools/>)

- AL8841QE1 Evaluation Board User Guide
- AL8841Q Spice Model (PSPICE Digital Simulation)
- AL8841Q Design Calculator

## Ordering Information



Part Number	Part Number Suffix	Identification Code	Package	Packing	
				Qty.	Carrier
AL8841QMP-13	-13	AL8841Q	MSOP-8EP	2500	Tape & Reel
AL8841QWT-7	-7	B2Q	TSOT25	3000	Tape & Reel

## Marking Information

### (1) MSOP-8EP

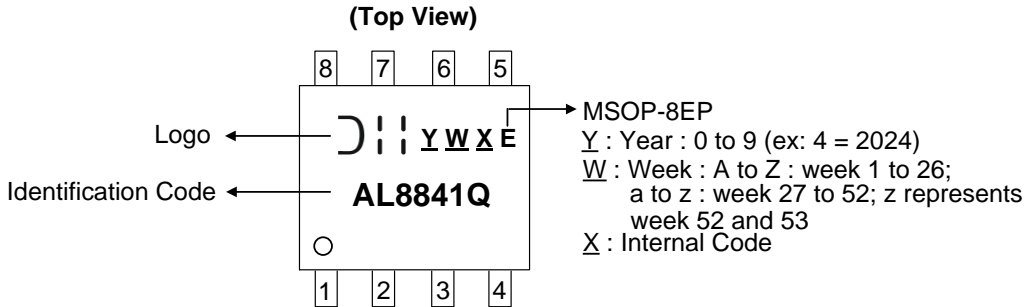

Part Number	Package	Identification Code
AL8841QMP-13	MSOP-8EP	AL8841Q

### (2) TSOT25

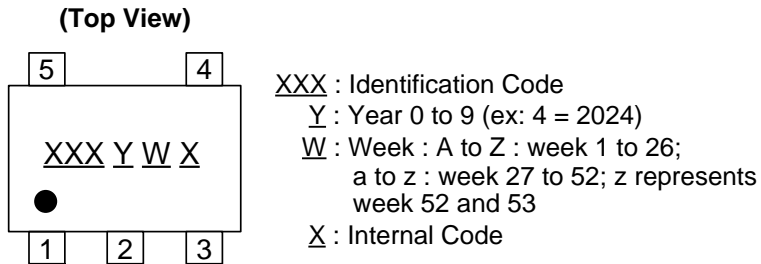

Part Number	Package	Identification Code
AL8841QWT-7	TSOT25	B2Q

**Package Outline Dimensions**

Please see <http://www.diodes.com/package-outlines.html> for the latest version.

**MSOP-8EP**

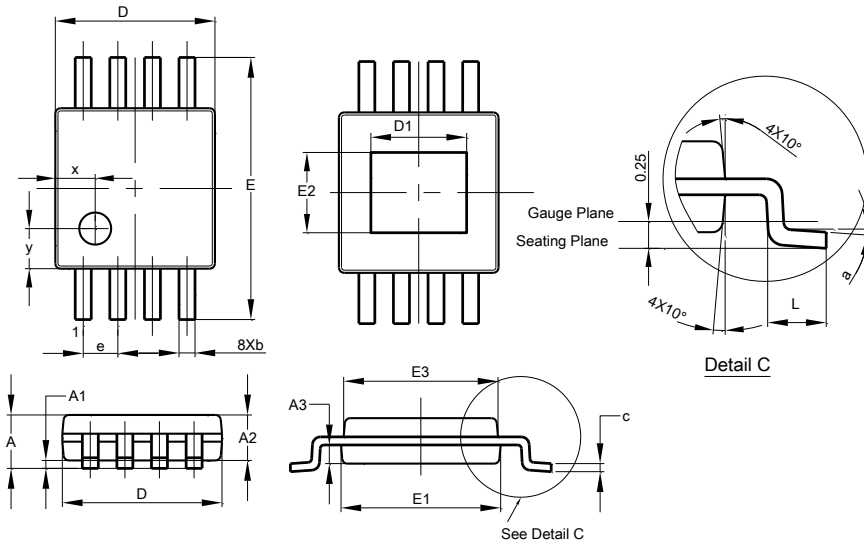

MSOP-8EP			
Dim	Min	Max	Typ
A	-	1.10	-
A1	0.05	0.15	0.10
A2	0.75	0.95	0.86
A3	0.29	0.49	0.39
b	0.22	0.38	0.30
c	0.08	0.23	0.15
D	2.90	3.10	3.00
D1	1.60	2.00	1.80
E	4.70	5.10	4.90
E1	2.90	3.10	3.00
E2	1.30	1.70	1.50
E3	2.85	3.05	2.95
e	-	-	0.65
L	0.40	0.80	0.60
a	0°	8°	4°
x	-	-	0.750
y	-	-	0.750
All Dimensions in mm			

**TSOT25**

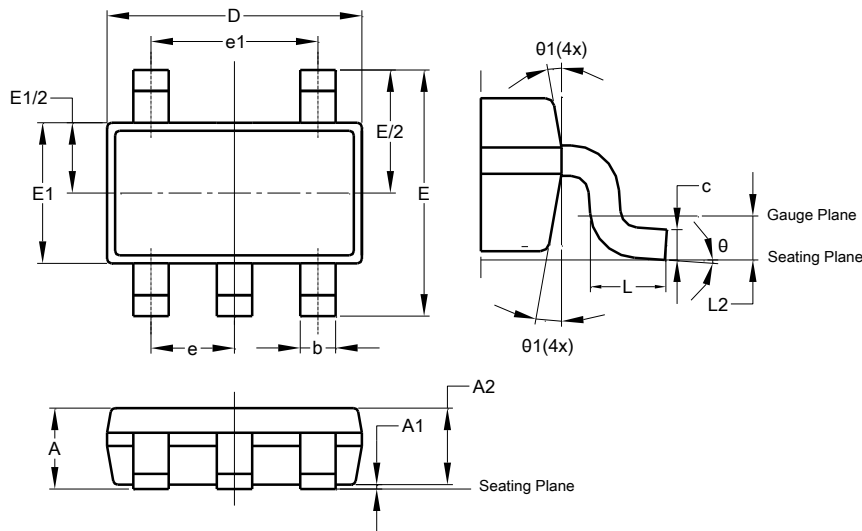

TSOT25			
Dim	Min	Max	Typ
A	-	1.00	-
A1	0.01	0.10	-
A2	0.84	0.90	-
b	0.30	0.45	-
c	0.12	0.20	-
D	-	-	2.90
E	-	-	2.80
E1	-	-	1.60
e	0.95 BSC		
e1	1.90 BSC		
L	0.30	0.50	-
L2	0.25 BSC		
$\theta$	0°	8°	4°
$\theta1$	4°	12°	-
All Dimensions in mm			

## Suggested Pad Layout

Please see <http://www.diodes.com/package-outlines.html> for the latest version.

### MSOP-8EP

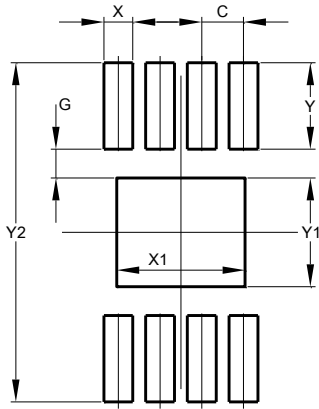

Dimensions	Value (in mm)
C	0.650
G	0.450
X	0.450
X1	2.000
Y	1.350
Y1	1.700
Y2	5.300

### TSOT25

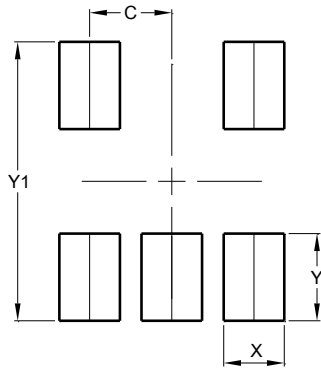

Dimensions	Value (in mm)
C	0.950
X	0.700
Y	1.000
Y1	3.199

## Mechanical Data

- Moisture Sensitivity: Level 1 per JESD22-A113
- Terminals: Matte Tin Plated Leads, Solderable per M2003 JESD22-B102 Ⓔ3
- Weight:
  - MSOP-8EP: 0.02756 grams (Approximate)
  - TSOT25: 0.01365 grams (Approximate)



**IMPORTANT NOTICE**

1. DIODES INCORPORATED (Diodes) AND ITS SUBSIDIARIES MAKE NO WARRANTY OF ANY KIND, EXPRESS OR IMPLIED, WITH REGARDS TO ANY INFORMATION CONTAINED IN THIS DOCUMENT, INCLUDING, BUT NOT LIMITED TO, THE IMPLIED WARRANTIES OF MERCHANTABILITY, FITNESS FOR A PARTICULAR PURPOSE OR NON-INFRINGEMENT OF THIRD PARTY INTELLECTUAL PROPERTY RIGHTS (AND THEIR EQUIVALENTS UNDER THE LAWS OF ANY JURISDICTION).
2. The Information contained herein is for informational purpose only and is provided only to illustrate the operation of Diodes' products described herein and application examples. Diodes does not assume any liability arising out of the application or use of this document or any product described herein. This document is intended for skilled and technically trained engineering customers and users who design with Diodes' products. Diodes' products may be used to facilitate safety-related applications; however, in all instances customers and users are responsible for (a) selecting the appropriate Diodes products for their applications, (b) evaluating the suitability of Diodes' products for their intended applications, (c) ensuring their applications, which incorporate Diodes' products, comply the applicable legal and regulatory requirements as well as safety and functional-safety related standards, and (d) ensuring they design with appropriate safeguards (including testing, validation, quality control techniques, redundancy, malfunction prevention, and appropriate treatment for aging degradation) to minimize the risks associated with their applications.
3. Diodes assumes no liability for any application-related information, support, assistance or feedback that may be provided by Diodes from time to time. Any customer or user of this document or products described herein will assume all risks and liabilities associated with such use, and will hold Diodes and all companies whose products are represented herein or on Diodes' websites, harmless against all damages and liabilities.
4. Products described herein may be covered by one or more United States, international or foreign patents and pending patent applications. Product names and markings noted herein may also be covered by one or more United States, international or foreign trademarks and trademark applications. Diodes does not convey any license under any of its intellectual property rights or the rights of any third parties (including third parties whose products and services may be described in this document or on Diodes' website) under this document.
5. Diodes' products are provided subject to Diodes' Standard Terms and Conditions of Sale (<https://www.diodes.com/about/company/terms-and-conditions/terms-and-conditions-of-sales/>) or other applicable terms. This document does not alter or expand the applicable warranties provided by Diodes. Diodes does not warrant or accept any liability whatsoever in respect of any products purchased through unauthorized sales channel.
6. Diodes' products and technology may not be used for or incorporated into any products or systems whose manufacture, use or sale is prohibited under any applicable laws and regulations. Should customers or users use Diodes' products in contravention of any applicable laws or regulations, or for any unintended or unauthorized application, customers and users will (a) be solely responsible for any damages, losses or penalties arising in connection therewith or as a result thereof, and (b) indemnify and hold Diodes and its representatives and agents harmless against any and all claims, damages, expenses, and attorney fees arising out of, directly or indirectly, any claim relating to any noncompliance with the applicable laws and regulations, as well as any unintended or unauthorized application.
7. While efforts have been made to ensure the information contained in this document is accurate, complete and current, it may contain technical inaccuracies, omissions and typographical errors. Diodes does not warrant that information contained in this document is error-free and Diodes is under no obligation to update or otherwise correct this information. Notwithstanding the foregoing, Diodes reserves the right to make modifications, enhancements, improvements, corrections or other changes without further notice to this document and any product described herein. This document is written in English but may be translated into multiple languages for reference. Only the English version of this document is the final and determinative format released by Diodes.
8. Any unauthorized copying, modification, distribution, transmission, display or other use of this document (or any portion hereof) is prohibited. Diodes assumes no responsibility for any losses incurred by the customers or users or any third parties arising from any such unauthorized use.
9. This Notice may be periodically updated with the most recent version available at <https://www.diodes.com/about/company/terms-and-conditions/important-notice>

The Diodes logo is a registered trademark of Diodes Incorporated in the United States and other countries.  
All other trademarks are the property of their respective owners.  
© 2024 Diodes Incorporated. All Rights Reserved.

[www.diodes.com](http://www.diodes.com)