

www.datasheet4u.com

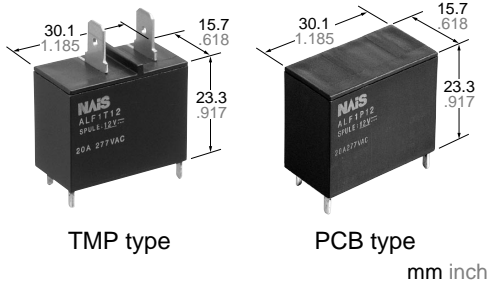

TMP type

PCB type

mm inch

FEATURES

- 1. Ideal for compressor and inverter loads**
 - 1) Compressor load: 20A 250V AC
 - 2) Inverter load: 20A 100V AC, 10A 200V AC
- 2. High insulation resistance**
 - Creepage distance and clearances between contact and coil; Creepage Min. 9.5mm .374inch/Clearance Min. 8mm .315inch
 - Surge withstand voltage: Min. 10,000V
- 3. "PCB" and "TMP" types available**
- 4. Conforms to the various safety standards:** UL/CSA, TÜV, VDE approved

SPECIFICATIONS

Contact

Arrangement	1 Form A	
Initial contact resistance, max. (By voltage drop 6 V DC 1 A)	100 mΩ	
Contact material	Silver alloy	
Rating (resistive load)	Nominal switching capacity	20 A 250V AC
	Max. switching power	6,250 V A
	Max. switching voltage	250V AC
	Max. switching current	25 A
Expected life (min. operations)	Mechanical (at 180 cpm)	2 × 10 ⁶
	Electrical (at 20 cpm) (Resistive load)	10 ⁵

Coil

Nominal operating power	900 mW
-------------------------	--------

Remarks

- * Specifications will vary with foreign standards certification ratings.
- *1 Measurement at same location as "Initial breakdown voltage" section.
- *2 Detection current: 10mA
- *3 Wave is standard shock voltage of $\pm 1.2 \times 50\mu s$ according to JEC-212-1981
- *4 Excluding contact bounce time.
- *5 Half-wave pulse of sine wave: 11 ms; detection time: 10 μs
- *6 Half-wave pulse of sine wave: 6 ms
- *7 Detection time: 10 μs
- *8 Refer to 5. Conditions for operation, transport and storage mentioned in AMBIENT ENVIRONMENT (Page 24).

Characteristics

Max. operating speed (at rated load)	20 cpm	
Initial insulation resistance*1	Min. 1,000 MΩ (at 500 V DC)	
Initial breakdown voltage*2	Between open contacts	1,000 Vrms for 1 min.
	Between contacts and coil	5,000 Vrms for 1 min.
Surge voltage between contact and coil*3	Min. 10,000 V	
Operate time*4 (at nominal voltage)	Approx. 15ms	
Release time (without diode)*4 (at nominal voltage)	Approx. 15ms	
Temperature rise (at nominal voltage)	Max. 45°C (resistance method, contact current 20 A, rated coil voltage, 60°C 140°F)	
Shock resistance	Functional*5	Min. 100 m/s ² {10 G}
	Destructive*6	Min. 1,000 m/s ² {100 G}
Vibration resistance	Functional*7	10 to 55Hz at double amplitude of 1.5mm
	Destructive	10 to 55Hz at double amplitude of 1.5mm
Conditions for operation, transport and storage*8 (Not freezing and condensing at low temperature)	Ambient temp.	-40°C to +60°C -40°F to +140°F
	Humidity	5 to 85% R.H.
Unit weight	Approx. 23 g .81 oz	

TYPICAL APPLICATIONS

- Air conditioner
- Refrigerators
- OA equipment

ORDERING INFORMATION

Ex. A LF 1 T 12

Product Name	Contact arrangement	Terminal shape	Coil voltage, V DC
LF	1: 1 Form A	T: TMP type P: PCB type	05: 5 12: 12 06: 6 18: 18 09: 9 24: 24

Note: Standard packing; Carton: 50 pcs. Case 200 pcs. UL/CSA, VDE, TÜV approved type is standard.

TYPES

Contact arrangement	Coil voltage, V DC	TMP type	PCB type
1 Form A	5	ALF1T05	ALF1P05
	6	ALF1T06	ALF1P06
	9	ALF1T09	ALF1P09
	12	ALF1T12	ALF1P12
	18	ALF1T18	ALF1P18
	24	ALF1T24	ALF1P24

www.datasheet4u.com

COIL DATA

Nominal voltage, V DC	Pick-up voltage, V DC (max.)	Drop-out voltage, V DC (min.)	Coil resistance, Ω(±10%)	Nominal operating current, mA (±10%)	Nominal operating power, W	Maximum allowable voltage, V DC
5	3.5	0.5	27.8	180	0.9	5.5
6	4.2	0.6	40	150		6.6
9	6.3	0.9	90	100		9.9
12	8.4	1.2	160	75		13.2
18	12.6	1.8	360	50		19.8
24	16.8	2.4	640	37.5		26.4

DIMENSIONS

mm inch

1. TMP type

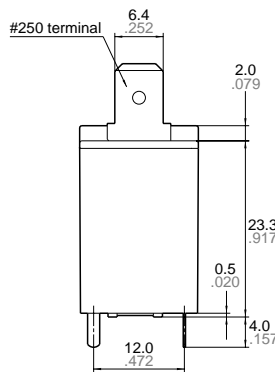
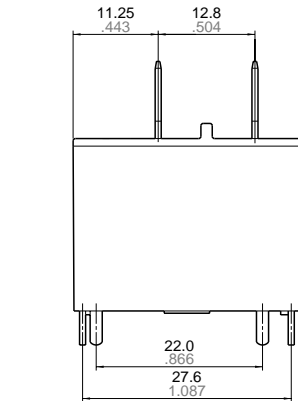

PC board pattern (Bottom view)

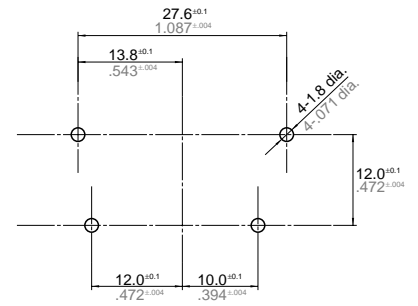

Tolerance : ±0.1 ±.004

Schematic (Bottom view)

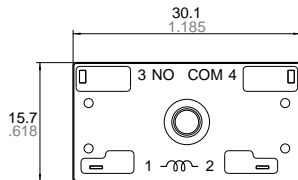
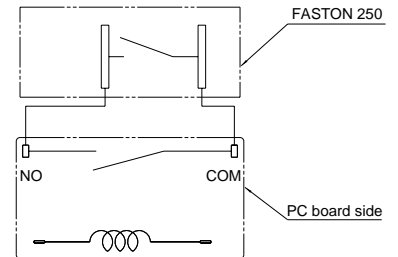

Dimension :

Max. 1mm .039 inch:
1 to 3mm .039 to .118 inch:
Min. 3mm .118 inch:

Tolerance

±0.1 ±.004
±0.2 ±.008
±0.3 ±.012

2. PCB type

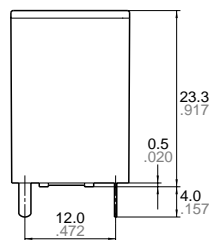
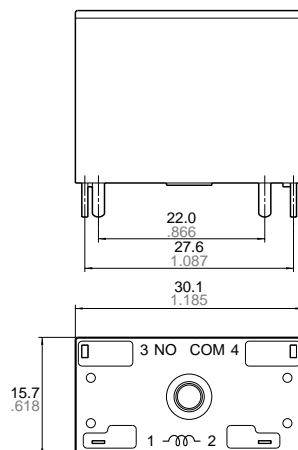

PC board pattern (Bottom view)

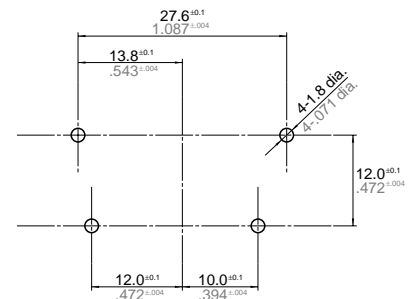

Tolerance : ±0.1 ±.004

Schematic (Bottom view)

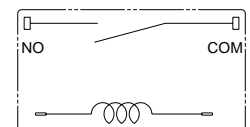

REFERENCE DATA

1. Coil temperature rise

Sample: ALF1T12, 6 pcs.
 Point measured: coil inside
 Contact current: 20A
 Ambient temperature: 25°C 77°F, 60°C 140°F

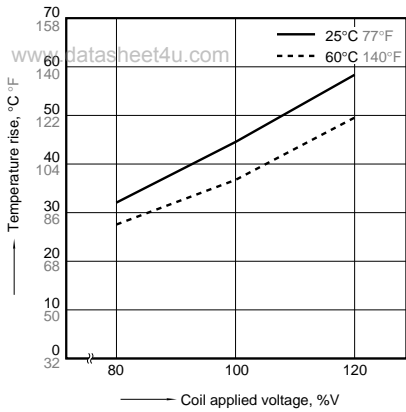

2-(1). 200V AC electrical life test

(200V AC, inverter load)
 Sample: ALF1T12, 6 pcs.
 Load: Inrush 102A (wave peak value),
 Steady 14.4A (wave peak value)
 Inverter dummy 200V AC
 Switching frequency: ON 1s, OFF 5s
 Circuit:

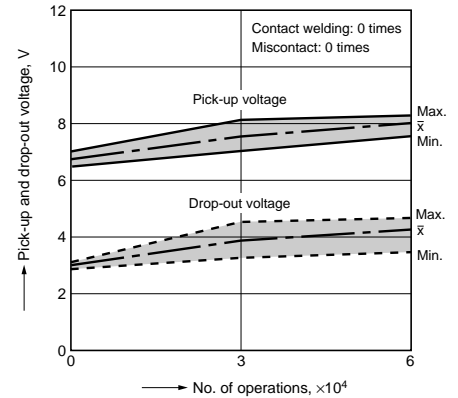
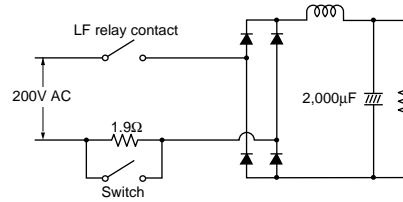

2-(2). 100V AC electrical life test

(100V AC, inverter load)
 Sample: ALF1T12, 6 pcs.
 Load: Inrush 224A (wave peak value),
 Steady 30.5A (wave peak value)
 Inverter dummy 100V AC
 Switching frequency: ON 1s, OFF 5s
 Circuit:

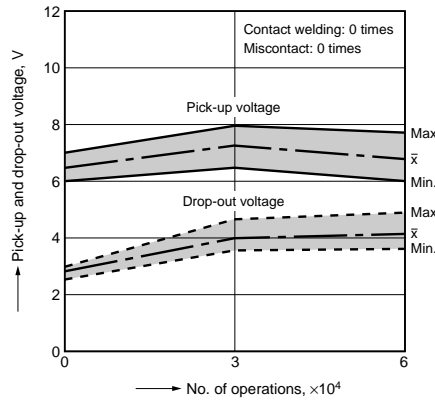
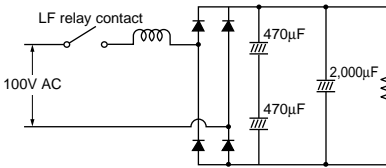

2-(3). Inrush 70.7A, Steady 20A, 250V AC electrical life test

(Compressor dummy load)
 Sample: ALF1T12, 3 pcs.
 Load: Inrush 70.7A, $\cos\phi = 0.7$
 Steady 20A, $\cos\phi = 0.9$
 250V AC compressor dummy
 Switching frequency: ON 1.5s, OFF 1.5s
 Circuit:

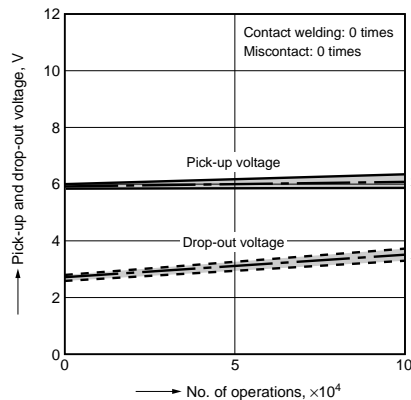
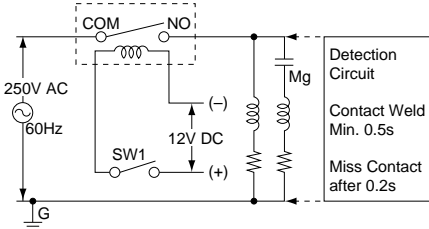

2-(4). Electrical life test

(20A 250V AC, resistive load)
 Sample: ALF1T12, 6 pcs.
 Switching frequency: ON 1.5s, OFF 1.5s

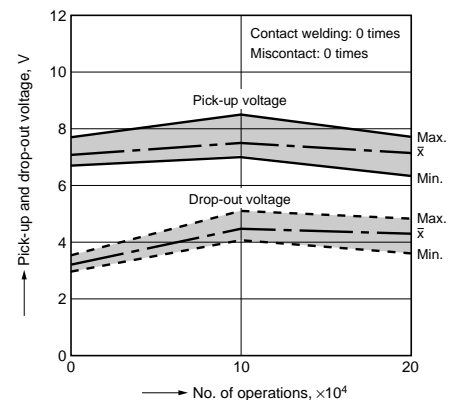

For Cautions for Use, see Relay Technical Information (Page 11 to 39).