

# ALM-31222

## 1.7-2.7GHz

### 1-Watt High Linearity Amplifier



## Data Sheet

### Description

Avago Technologies' ALM-31222 is a high linearity 1 Watt PA with good OIP3 performance and exceptionally good PAE at 1dB gain compression point, achieved through the use of Avago Technologies' proprietary 0.25um GaAs Enhancement-mode pHEMT process.

All matching components are fully integrated within the module. This makes the ALM-31222 extremely easy to use. The adjustable temperature-compensated internal bias circuit allows the device to be operated at either class A or class AB operation.

The ALM-31222 is housed inside a miniature 5.0 x 6.0 x 1.1 mm<sup>3</sup> 22-lead multiple-chips-on-board (MCOB) module package.

### Component Image

5.0 x 6.0 x 1.1 mm<sup>3</sup> 22-lead MCOB

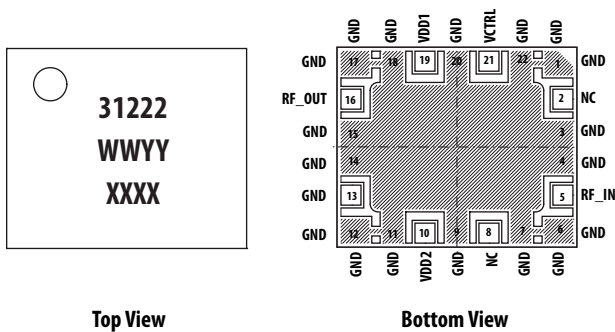

Notes:  
 Package marking provides orientation and identification  
 "31222" = Device Part Number  
 "WWYY" = Work week and Year of manufacture  
 "XXXX" = Last 4 digit of Lot number

### Features

- Fully matched, input and output
- High linearity and P1dB
- Unconditionally stable across load condition
- Built-in adjustable temperature-compensated internal bias circuitry
- GaAs E-pHEMT Technology<sup>[1]</sup>
- 5V supply
- Excellent uniformity in product specifications
- Tape-and-Reel packaging option available
- MSL-3 and Lead-free
- High MTTF for base station application

### Specifications

2GHz; 5V, 415mA (typical)

- 14.9 dB Gain
- 47.9 dBm Output IP3
- 31.5 dBm Output Power at 1dB gain compression
- 52.6% PAE at P1dB
- 2.7 dB Noise Figure

### Applications

- Class A driver amplifier for GSM/PCS/W-CDMA/WiMAX Base Stations.
- General purpose gain block.

Note:

1. Enhancement mode technology employs positive gate voltage, thereby eliminating the need of negative gate voltage associated with conventional depletion mode devices.



**Attention: Observe precautions for handling electrostatic sensitive devices.**

ESD Machine Model = 200 V  
 ESD Human Body Model = 700 V  
 Refer to Avago Application Note A004R:  
*Electrostatic Discharge, Damage and Control.*

## Absolute Maximum Rating <sup>[2]</sup> T<sub>A</sub>=25°C

Symbol	Parameter	Units	Absolute Max.
V <sub>dd,max</sub>	Device Voltage, RF output to ground	V	5.5
I <sub>ds,max</sub>	Device Drain Current	mA	750
V <sub>ctrl,max</sub>	Control Voltage	V	5.5
P <sub>in,max</sub>	CW RF Input Power	dBm	25
P <sub>diss</sub>	Total Power Dissipation <sup>[4]</sup>	W	4.125
T <sub>j,max</sub>	Junction Temperature	°C	150
T <sub>STG</sub>	Storage Temperature	°C	-65 to 150

Thermal Resistance <sup>[3]</sup>  $\theta_{jc} = 25 \text{ }^\circ\text{C/W}$   
(V<sub>dd</sub> = 5V, I<sub>dd</sub> = 400mA, T<sub>c</sub> = 85 °C)

Notes:

2. Operation of this device in excess of any of these limits may cause permanent damage.
3. Thermal resistance measured using Infra-Red measurement technique.
4. This is limited by maximum V<sub>dd</sub> and I<sub>ds</sub>. Derate 40mW/°C for T<sub>c</sub>>46.9°C.

## Product Consistency Distribution Charts<sup>[5, 6]</sup>

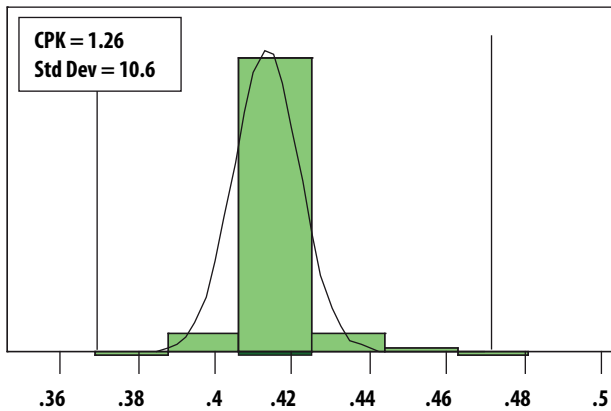

Figure 1: I<sub>ds</sub>; LSL = 370mA, nominal = 415mA, USL = 470mA

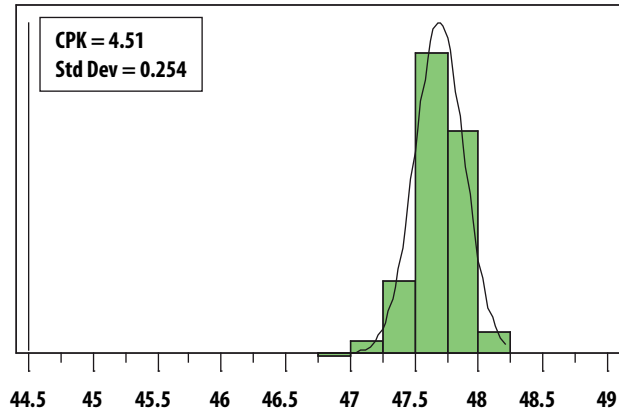

Figure 2: OIP<sub>3</sub>; LSL = 44.5dBm, nominal = 47.9dBm

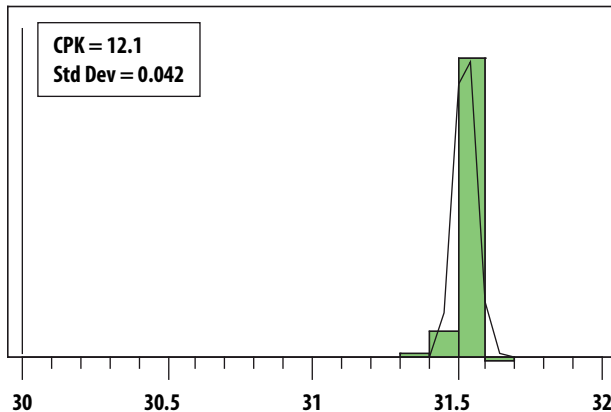

Figure 3: P<sub>1dB</sub>; LSL = 30dBm, nominal = 31.5dBm

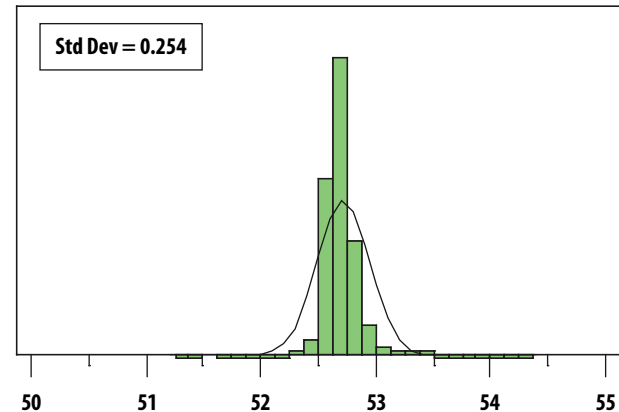

Figure 4: PAE at P<sub>1dB</sub>; nominal = 52.6%

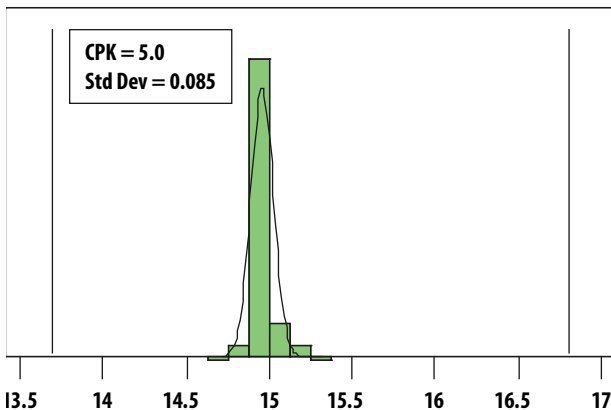

Figure 5: Gain; LSL=13.7dB, Nominal = 14.9dB, USL=16.8dB

Notes:

5. Distribution data sample size is 500 samples taken from 2 different wafers lots. T<sub>A</sub> = 25°C, V<sub>dd</sub> = 5V, V<sub>ctrl</sub> = 5V, RF performance at 2GHz unless otherwise specified. Future wafers allocated to this product may have nominal values anywhere between the upper and lower limits.
6. Measurements are made on a production test board. Input trace losses have not been de-embedded from actual measurements.

## Electrical Specifications [7]

$T_A = 25\text{ }^\circ\text{C}$ ,  $V_{dd} = 5\text{V}$ ,  $V_{ctrl} = 5\text{V}$ , RF performance at 2.0 GHz, measured on demo board (see Figure 7) unless otherwise specified.

Symbol	Parameter and Test Condition	Units	Min.	Typ.	Max.
I <sub>ds</sub>	Quiescent current	mA	370	415	470
I <sub>ctrl</sub>	V <sub>ctrl</sub> current	mA	-	10.4	-
Gain	Gain	dB	13.7	14.9	16.8
OIP3 [8]	Output Third Order Intercept Point	dBm	44.5	47.9	-
OP1dB	Output Power at 1dB Gain Compression	dBm	30	31.5	-
PAE	Power Added Efficiency	%	-	52	-
NF	Noise Figure	dB	-	2.7	-
S11	Input Return Loss, 50Ω source	dB	-	-10	-
S22	Output Return Loss, 50Ω load	dB	-	-10	-
S12	Reverse Isolation	dB	-	-30	-

### Notes:

- Measurements at 2GHz obtained using demo board described in Figure 6 and 7.
- 2GHz OIP3 test condition:  $F_{RF1} - F_{RF2} = 10\text{MHz}$  with input power of -5dBm per tone measured at worse case side band.
- Use proper bias, heat sink and de-rating to ensure maximum channel temperature is not exceeded. See absolute maximum ratings and application note (if applicable) for more details.

**S-Parameter (Vdd=5V, Vctrl=5V, T=25°C, matched 50 ohm)**

Freq (GHz)	S11 (dB)	S11 (ang)	S21 (dB)	S21 (ang)	S12 (dB)	S12 (ang)	S22 (dB)	S22 (ang)
0.1	-0.28	175.96	-83.18	176.23	-85.32	-67.51	-1.24	-142.79
0.2	-0.33	173.13	-52.64	161.11	-79.55	71.39	-1.1	-167.79
0.3	-0.32	169.83	-39.35	128.52	-75.05	83.66	-1.02	179.87
0.4	-0.38	166.32	-29.95	100.99	-69.64	85.21	-0.99	169.14
0.5	-0.39	162.45	-23.54	79.41	-68.48	69.93	-1.01	158.91
0.6	-0.51	158	-17.63	69.24	-65.17	52.89	-1.05	147.9
0.7	-0.57	152.77	-11.35	54.33	-60.41	26.3	-1.17	134.94
0.8	-0.78	146.84	-5.72	35.54	-56.11	6.3	-1.45	119.17
0.9	-0.82	139.57	-0.4	13.28	-51.07	-19.9	-2.03	99.51
1	-1.16	129.83	4.3	-13.32	-46.1	-49.33	-3.2	75.34
1.1	-1.48	119.45	8.01	-41.24	-42.01	-78.55	-5.01	50.04
1.2	-2.16	104.83	11.14	-73.66	-38.32	-111.37	-7.73	22.1
1.3	-3.45	86.86	13.49	-106.74	-35.37	-144.38	-10.47	-3.04
1.4	-5.75	64.05	15.1	-139.71	-33.12	-176.73	-11.98	-25.11
1.5	-9.86	34.92	16.01	-171.85	-31.64	151.79	-11.99	-48.46
1.6	-16.32	-12.66	16.29	157.85	-30.83	122.31	-11.45	-73.83
1.7	-18.73	-104.19	16.1	130.8	-30.55	96.01	-11.22	-98.63
1.8	-15.14	-151.56	15.8	108.62	-30.51	74.43	-11.43	-119.98
1.9	-12.68	-179.03	15.4	86.61	-30.55	52.91	-12.04	-141.78
2	-11.46	157.09	15.05	64.4	-30.61	31.14	-13.09	-165.11
2.1	-10.95	139.46	14.78	46.1	-30.69	13.01	-14.18	174.4
2.2	-10.67	120.01	14.51	26.44	-30.8	-6.7	-15.59	149.47
2.3	-10.67	101.25	14.25	6.6	-30.97	-26.97	-17.05	119.92
2.4	-10.76	80.58	13.98	-13.62	-31.23	-47.79	-18.2	83.09
2.5	-11.08	60.42	13.69	-32.78	-31.57	-67.87	-18.1	43.43
2.6	-11.15	35.78	13.32	-54.85	-32.11	-90.91	-16.32	1.98
2.7	-11.14	8.61	12.79	-78.85	-32.95	-114.76	-13.6	-31.62
2.8	-10.62	-17.4	11.76	-105.67	-34.13	-137.54	-10.54	-58.62
2.9	-9.29	-41.86	9.7	-131.03	-34.8	-158.21	-7.5	-85.47
3	-7.64	-67.59	7.59	-150.93	-35.42	175.41	-5.5	-111.51
3.1	-6.29	-92.79	5.59	-171.05	-36.65	148.66	-4.2	-132.99
3.2	-5.37	-113.14	3.48	170.73	-38.05	126.66	-3.34	-149.42
3.3	-4.44	-133.05	0.91	152.1	-39.61	105.49	-2.67	-164.34
3.4	-3.78	-150.27	-1.89	135.32	-41.07	87.89	-2.19	-176.6
3.5	-3.23	-165.06	-4.83	120.49	-42.43	73.22	-1.87	173.41
3.6	-2.89	-178.18	-7.85	107.48	-43.41	61.54	-1.65	165.31
3.7	-2.64	170.43	-10.94	96.02	-44.11	52.9	-1.5	158.68
3.8	-2.53	159.49	-14.05	85.79	-44.41	45.89	-1.38	153.37
3.9	-2.55	149.92	-17.01	77.16	-44.37	39.92	-1.3	149.34
4	-2.7	138.27	-20.45	68.04	-43.94	32.99	-1.23	145.77

Freq (GHz)	S11 (dB)	S11 (ang)	S21 (dB)	S21 (ang)	S12 (dB)	S12 (ang)	S22 (dB)	S22 (ang)
4.1	-3.12	124.98	-24.48	59.64	-43.26	24.59	-1.19	142.81
4.2	-4	107.04	-29.94	54.26	-42.41	14.09	-1.16	140.48
4.3	-5.88	80.14	-38.62	78.06	-41.52	0.14	-1.14	138.59
4.4	-9.12	29.56	-35.16	141.21	-40.94	-18.9	-1.14	137.06
4.5	-8.89	-53.48	-31.02	131.79	-41.43	-41.31	-1.14	135.82
4.6	-5.46	-101.97	-30.5	114.9	-43	-59.92	-1.15	134.88
4.7	-3.25	-130.17	-31.67	99.57	-45.29	-73.84	-1.17	134.07
4.8	-2.22	-146.59	-33.51	88.44	-47.71	-82.07	-1.19	133.29
4.9	-1.67	-156.9	-35.58	80.35	-49.9	-85.77	-1.21	132.54
5	-1.38	-164.03	-37.74	74.33	-51.68	-87.52	-1.25	131.78
5.1	-1.19	-168.88	-39.92	69.9	-53.54	-88.6	-1.29	130.96
5.2	-1.08	-172.79	-42	66.23	-55.04	-88.69	-1.34	130.02
5.3	-1	-175.55	-44.09	63.38	-56.69	-88.55	-1.39	128.84
5.4	-0.97	-177.74	-46.1	60.82	-57.75	-86.81	-1.45	127.63
5.5	-0.93	-179.47	-48.16	58.9	-59.67	-84.83	-1.51	125.96
5.6	-0.91	178.98	-50.38	55.72	-61.1	-80.67	-1.6	123.94
5.7	-0.89	177.9	-52.39	55.19	-62.67	-75.2	-1.69	121.57
5.8	-0.88	176.77	-54.31	53.59	-64.48	-61.6	-1.78	118.67
5.9	-0.89	175.77	-56.07	50.42	-65.31	-47.79	-1.9	115.35
6	-0.91	174.44	-58.26	46.84	-64.83	-33.25	-2.01	111.39

## Demo Board Schematic

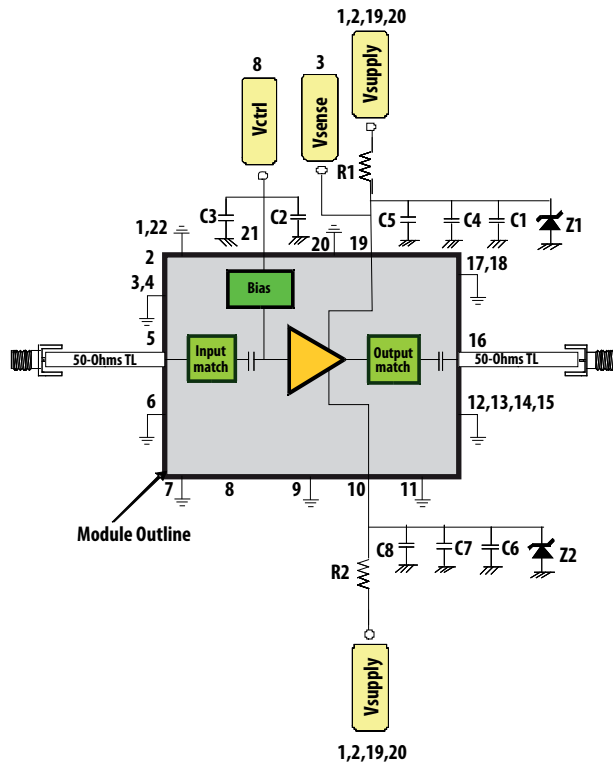

Circuit Symbol	Size	Value	Description
C1, C6	0805	2.2uF	Ceramic Chip Capacitor
C2, C4, C8	0402	0.1uF	Ceramic Chip Capacitor
C3, C5, C7	0402	10nF	Ceramic Chip Capacitor
R1	0805	0 Ohm	Chip Resistor
R2	0805	Not Used	N/A
Z1, Z2	0805	Not Used	Zener Diode 5.6V (Optional)

Figure 6. Demo board application schematics and components table

## Demo Board Layout

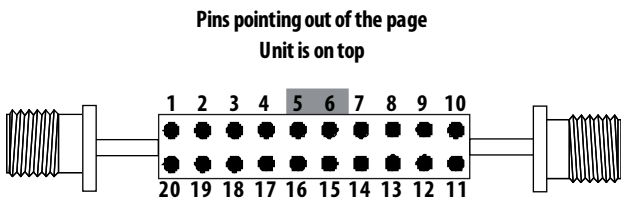

**Pins 1,2,19,20 = Vsupply = Vdd**  
**Pin 3 = Vsense (optional)**  
**Pins 5,6,15,16 = GND**  
**Pin 8 = Vctrl**

**Other pins are not used**

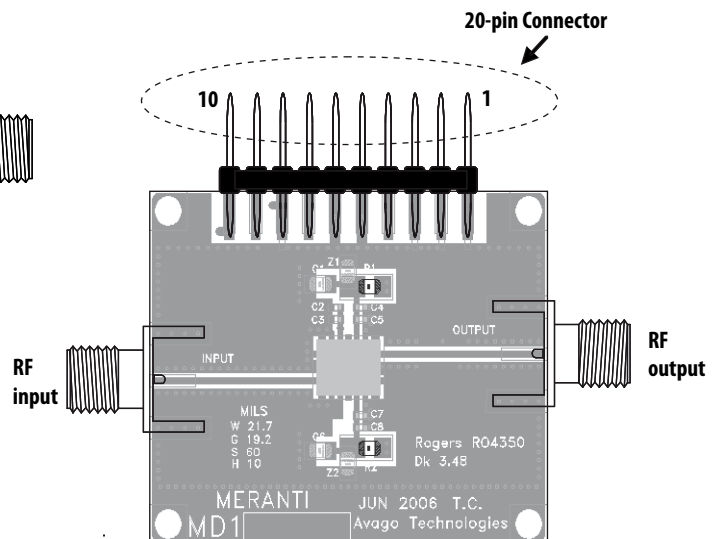

Figure 7. Demo Board Layout Diagram

1. Recommended PCB material is 10 mils Rogers RO4350, with FR4 backing for mechanical strength.
2. Suggested component values may vary according to layout and PCB material.

## ALM-31222 Typical Performance

$T_A = +25^\circ\text{C}$ ,  $V_{dd} = 5\text{V}$ ,  $V_{ctrl} = 5\text{V}$ , Input Signal=CW unless stated otherwise.

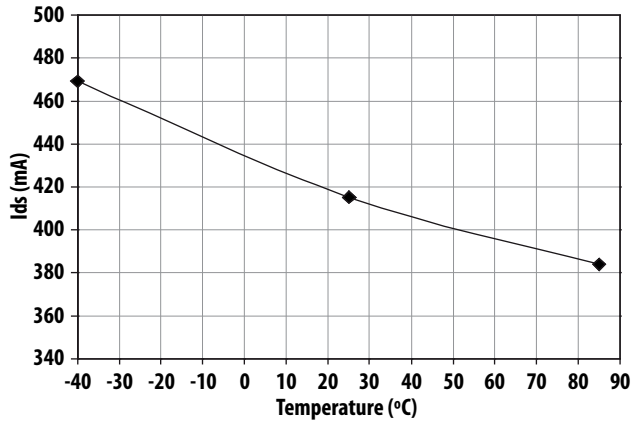

Figure 8. Ids vs Temperature

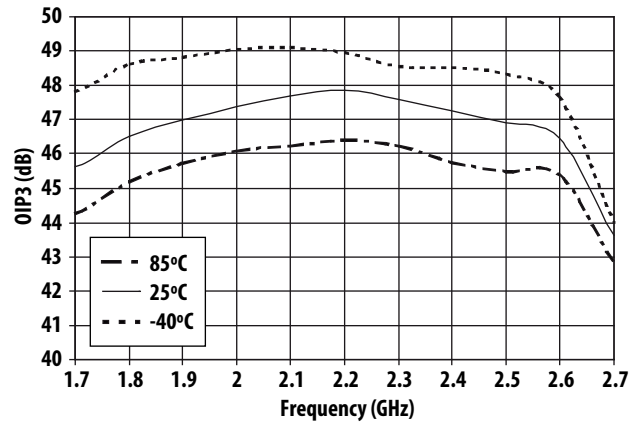

Figure 9. Over temperature OIP3 vs Frequency

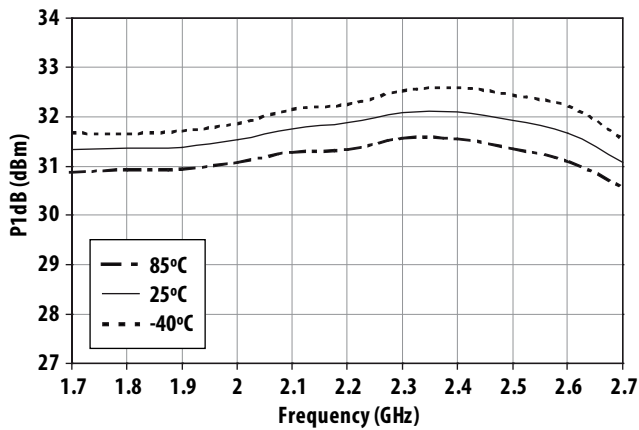

Figure 10. Over temperature P1dB vs Frequency

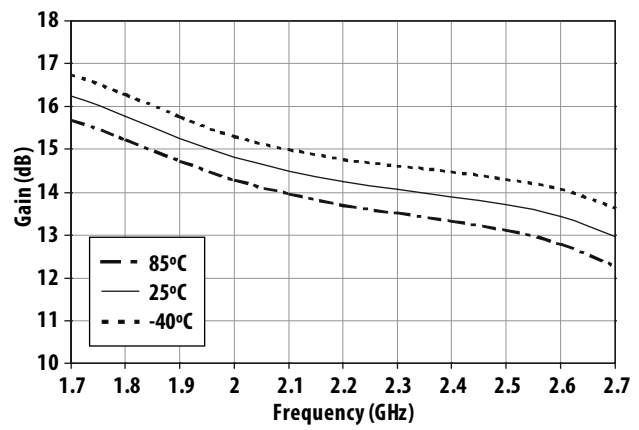

Figure 11. Over temperature Gain vs Frequency

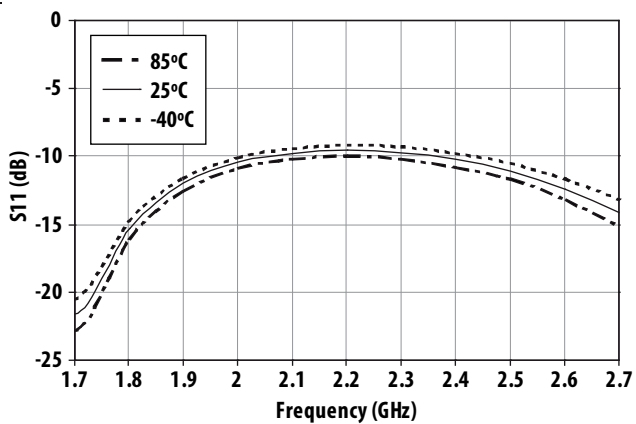

Figure 12. Over temperature S11 vs Frequency

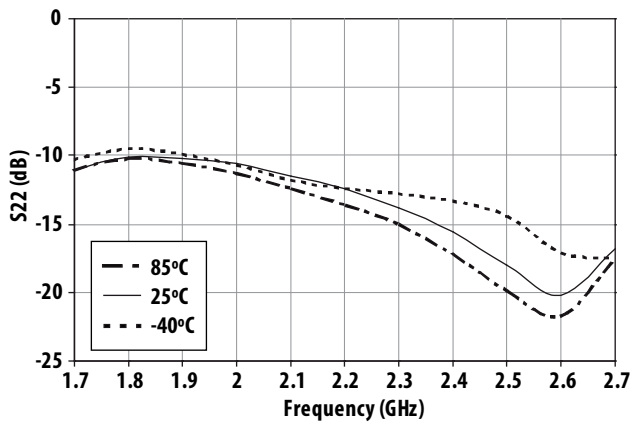

Figure 13. Over temperature S22 vs Frequency

## ALM-31222 Typical Performance

T<sub>A</sub> = +25°C, V<sub>dd</sub> = 5V, V<sub>ctrl</sub> = 5V, Input Signal=CW unless stated otherwise.

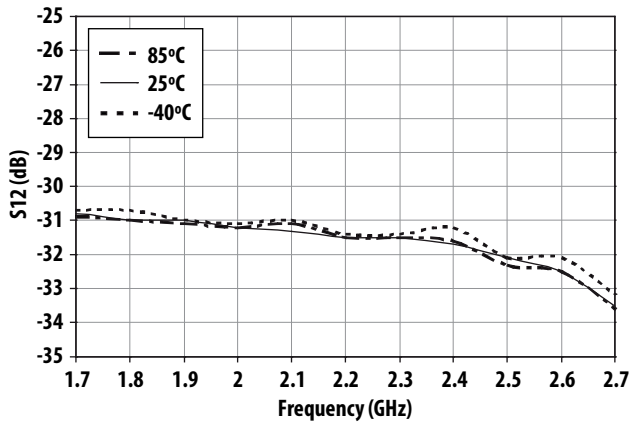

Figure 14. Over temperature S12 vs Frequency

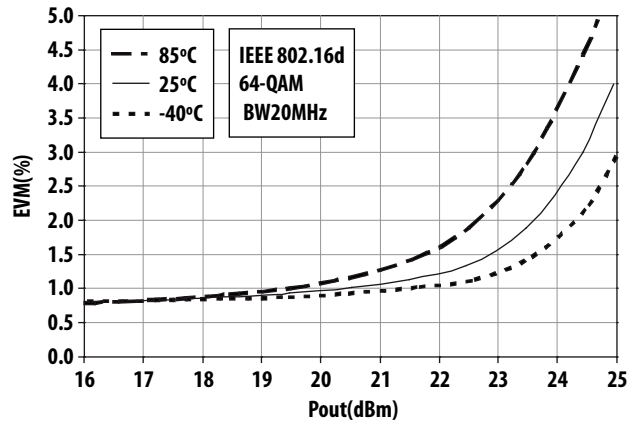

Figure 15. Over temperature EVM vs Pout at 2.5GHz

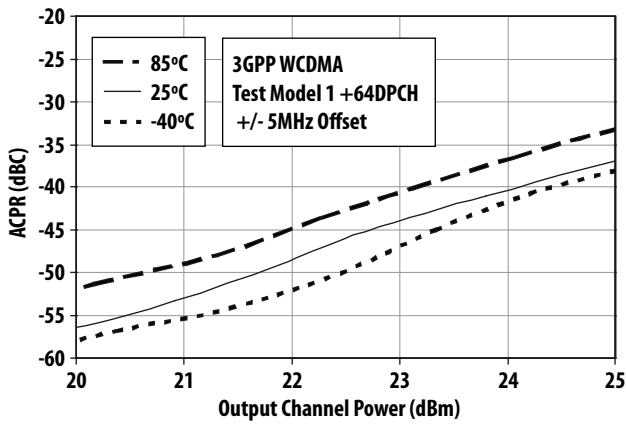

Figure 16. Over temperature ACPR vs Channel Power at 2.14GHz

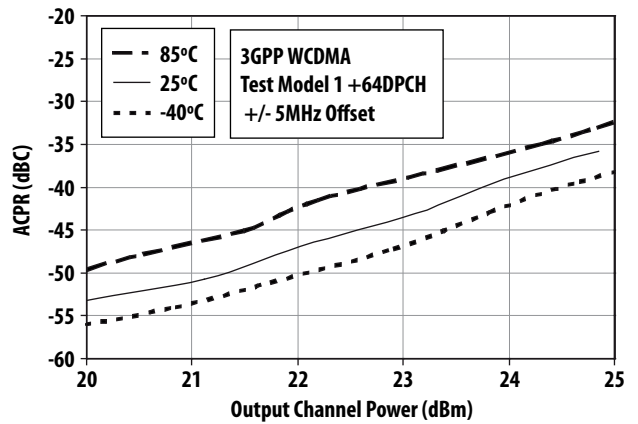

Figure 17. Over temperature ACPR vs Channel Power at 2.5GHz

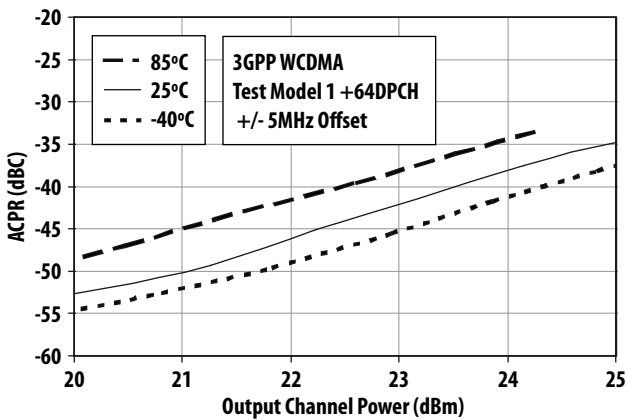

Figure 18. Over temperature ACPR vs Channel Power at 2.6GHz

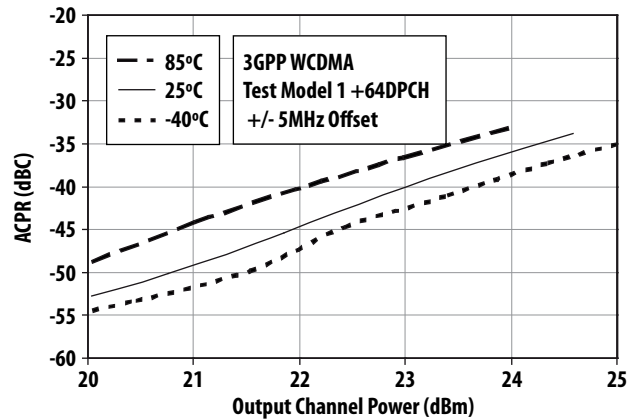
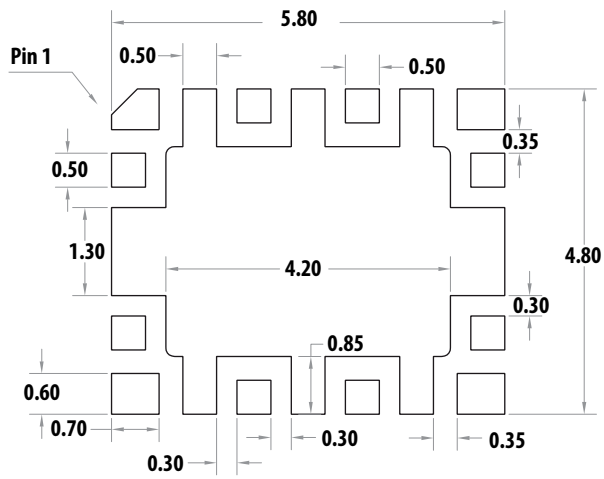

Figure 19. Over temperature ACPR vs Channel Power at 2.7GHz



## PCB Layout and Stencil Design



PCB Land Pattern

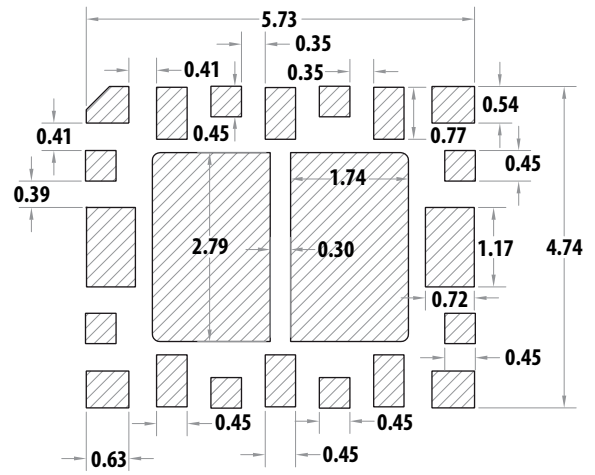

Stencil Opening

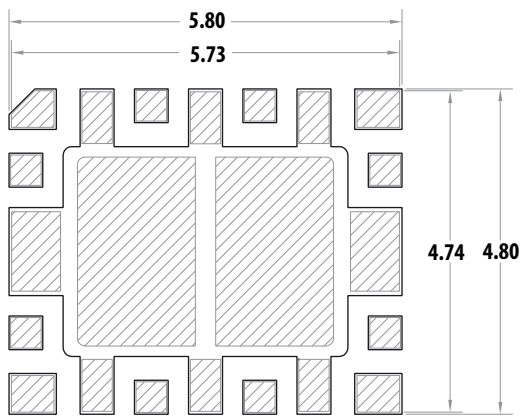

Combines Land Pattern and Stencil Layout

Note:  
All dimensions are in millimeters.

## MCOB 5x6 Package Dimensions

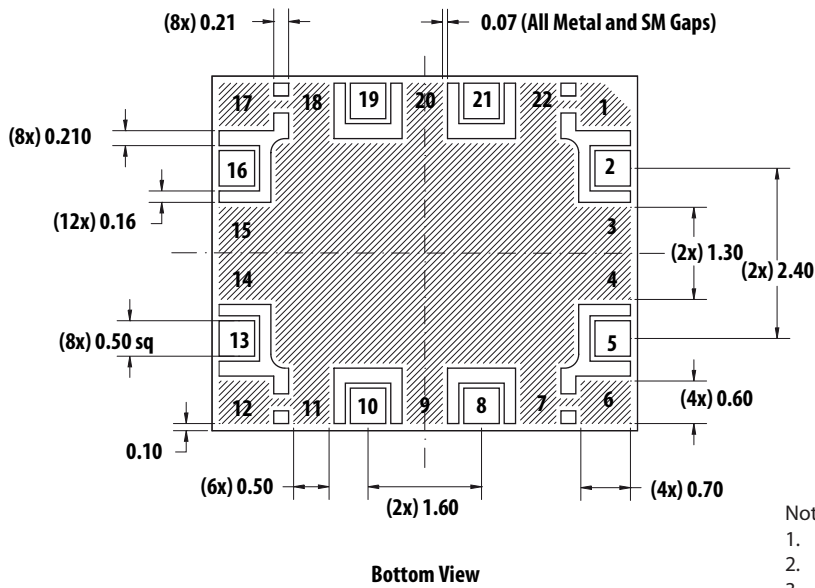
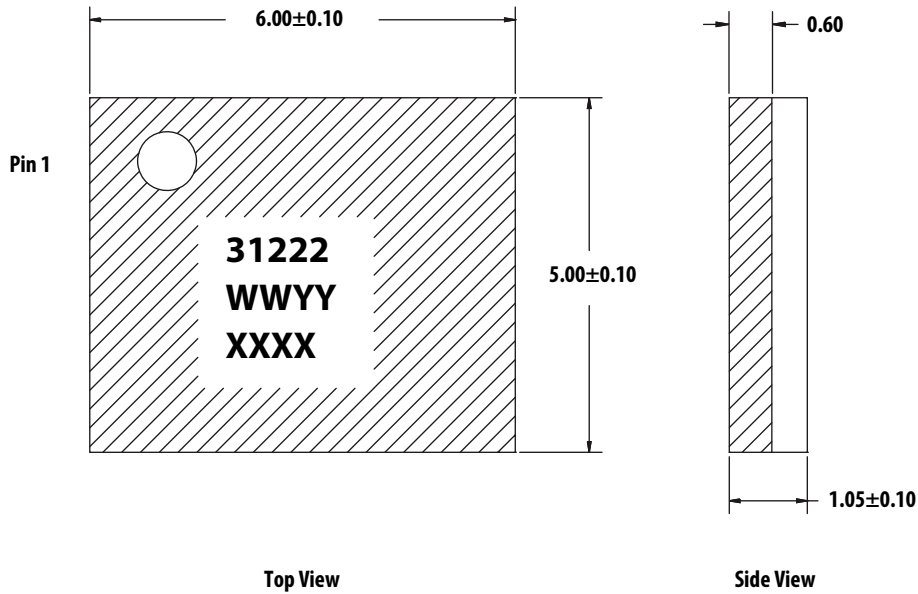

**Notes:**

1. All dimensions are in millimeters
2. Dimensions are inclusive of plating
3. Dimensions are exclusive of mold flash and metal burr

### Part Number Ordering Information

Part Number	No. of Devices	Container
ALM31222-TR1G	1000	7" Reel
ALM31222-TR2G	3000	13" Reel
ALM31222-BLKG	100	antistatic bag

### Product Family

Output Power	Frequency Band		
	700MHz-1GHz	1.7- 2.7GHz	3.3-3.9GHz
0.5W	MGA-30116	MGA-30216	MGA-30316
1W	ALM-31122	ALM-31222	ALM-31322
2W	ALM-32120	ALM-32220	ALM-32320

## Device Orientation

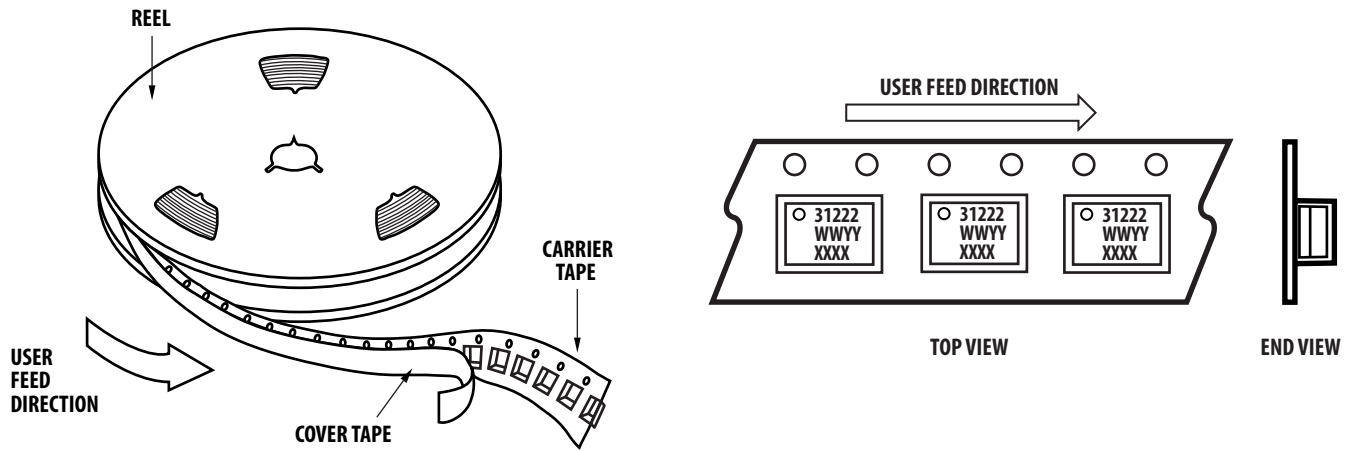

## Tape Dimensions

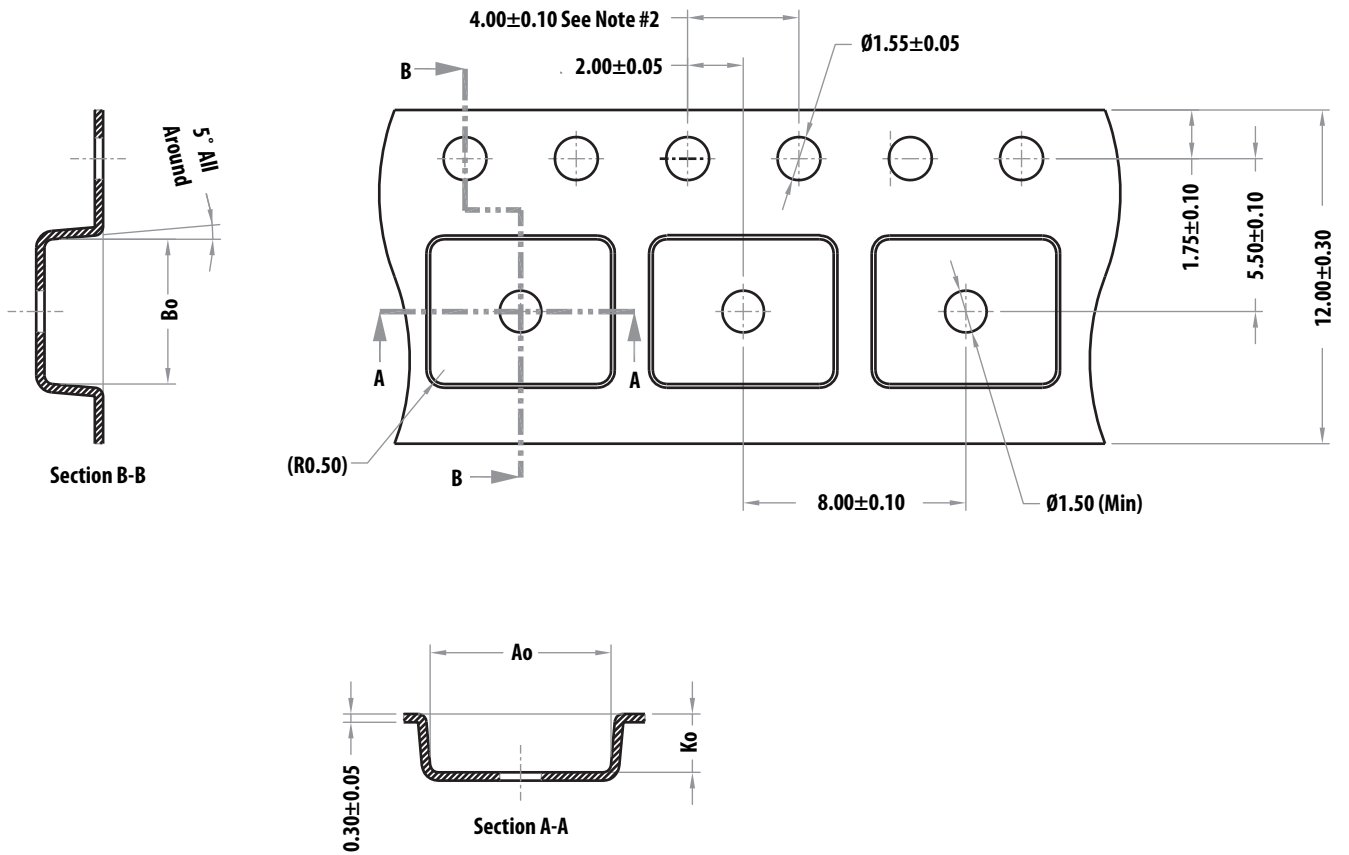

# Reel Dimension - 7 inch

