

Features

- 27 dB Gain at 2045 MHz
- +20 dBm P1dB
- +38 dBm Output IP3
- 0.9 dB Noise Figure
- 5 dBm WCDMA(4FA)
- Operating at Single 5V Supply
- 80 mA Current Consumption
- +5 dBm Max. Input RF Power

The plerow™ ALN-series LNA is compact-sized RF mini-modules that are widely applicable as low noise amplifier and general purpose gain block for use in mobile infrastructure equipments such as cellular, GSM, PCS, IMT-2000 and so on. This mini-modules are available in surface-mount package and provide exceptionally low noise with outstanding gain and linearity performance. The LNA designed with low current consumption less than 1 watt also makes telecommunication systems more reliable.

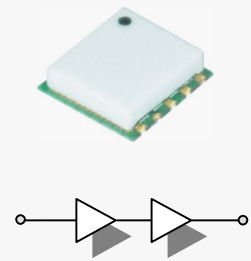

2-stage Single Type

Specifications

Parameter	Unit	Specification
Frequency Range	MHz	1920 ~ 2170
Gain	dB	27
Gain Flatness	dB	± 0.5
Noise Figure	dB	0.9
Output IP3 (min)	dBm	38
ACLR @5 dBm Pout and 4 FA WCDMA	dBc	- 45 @±5 MHz - 50 @±10 MHz
VSWR	-	1.5
Output P1dB	dBm	20
Supply Current	mA	80
Supply Voltage	V	5
Impedance	Ω	50
Max. RF Input Power	dBm	+5
Package Type & Size	mm	SMT, 13Wx13Lx3.8H

- 1) Measurement conditions are as follows: T = 25°C, V_{CC} = 5 V, Freq. = 2045 MHz, 50 ohm system.
- 2) OIP3 is measured with two tones at an output power of +10 dBm/tone separated by 1 MHz.
- 3) Note: We recommend that the VSWR toward a source and load be less than 1:4 to avoid an unwanted oscillation.

More Information

Website: www.asb.co.kr
E-mail: sales@asb.co.kr

Tel: (82) 42-528-7220
Fax: (82) 42-528-7222

ASB Inc., 4th Fl. Venture Town Bldg., 367-17 Goijeong-Dong, Seo-Gu, Daejeon 302-716, Korea

Outline Drawing

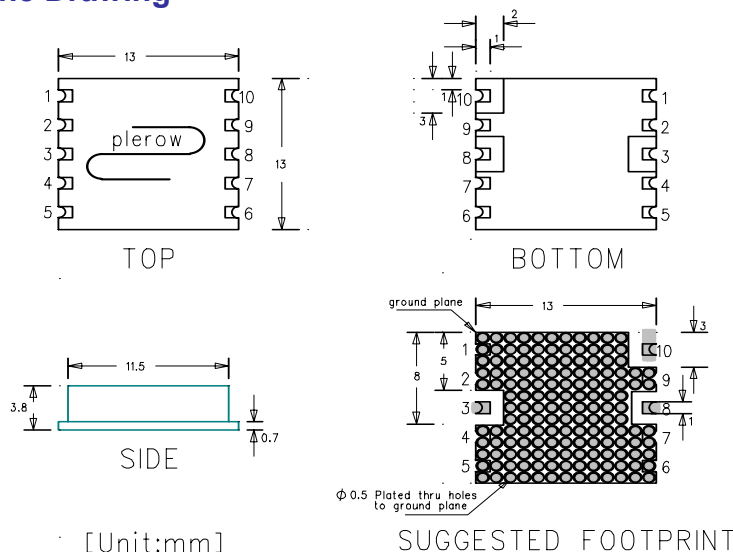

Pin Number	Function
3	RF In
8	RF Out
10	+Vcc
Others	Ground

- Note: 1. The number and size of ground via holes in a circuit board is critical for thermal RF grounding considerations.
2. We recommend that the ground via holes be placed on the bottom of all ground pins for better RF and thermal performance, as shown in the drawing at the left side.

S-parameters

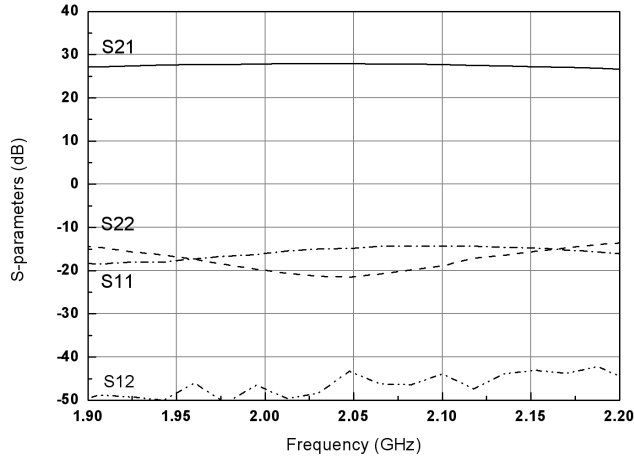

Stability Factor (K)

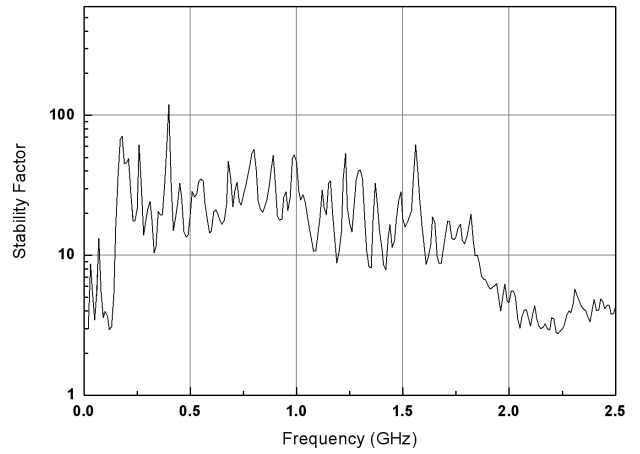

Noise Figure & Gain Flatness

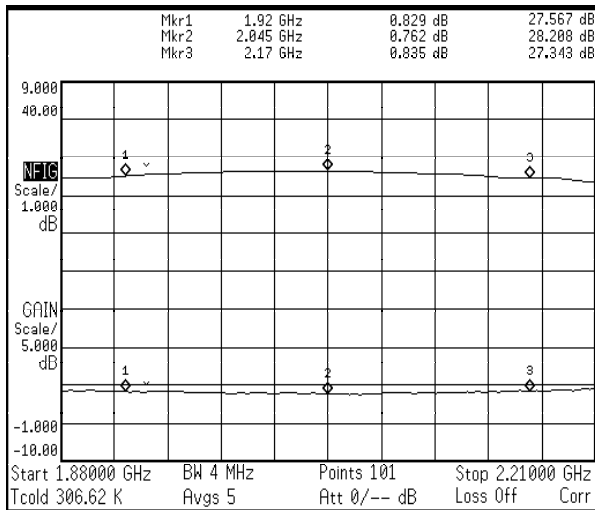

OIP3

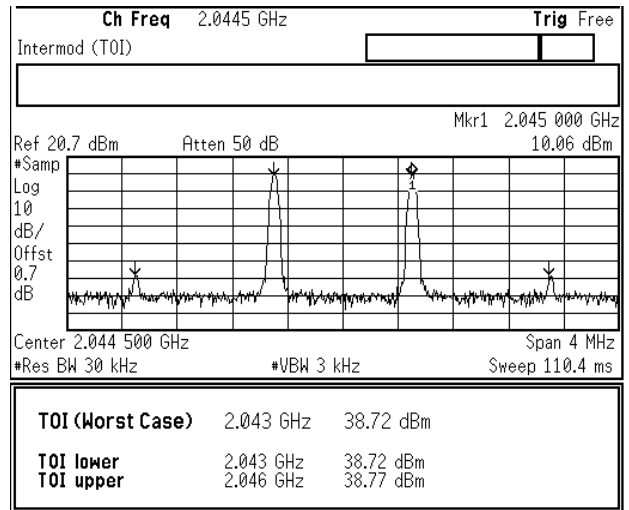

P1dB

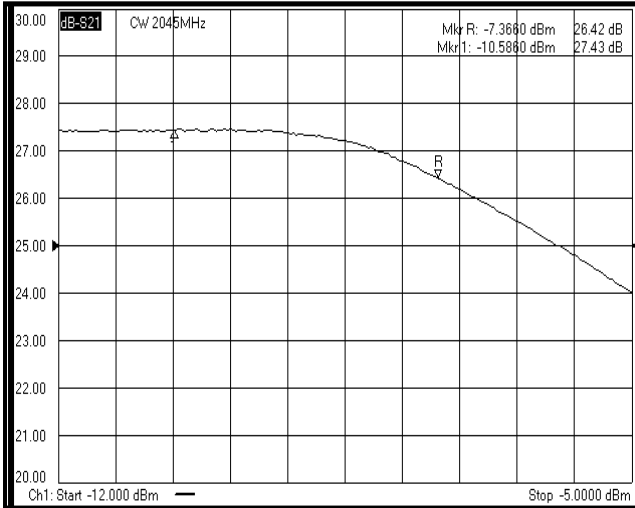

ACLR @14 dBm P_{OUT} for 1 FA WCDMA

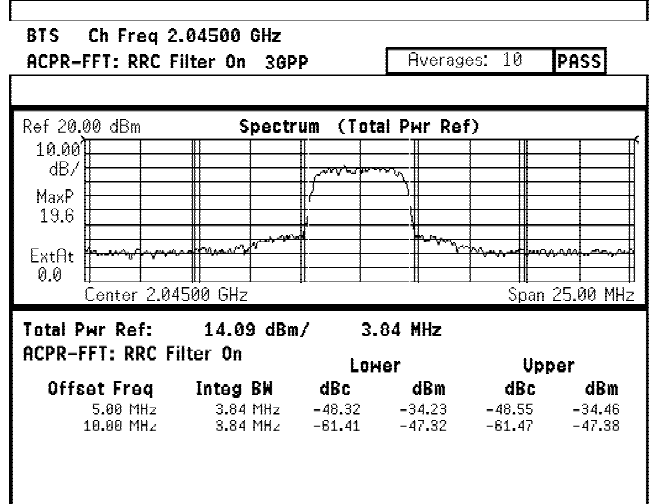

ACLR @5 dBm P_{OUT} for 4 FA WCDMA (SK Telecom)

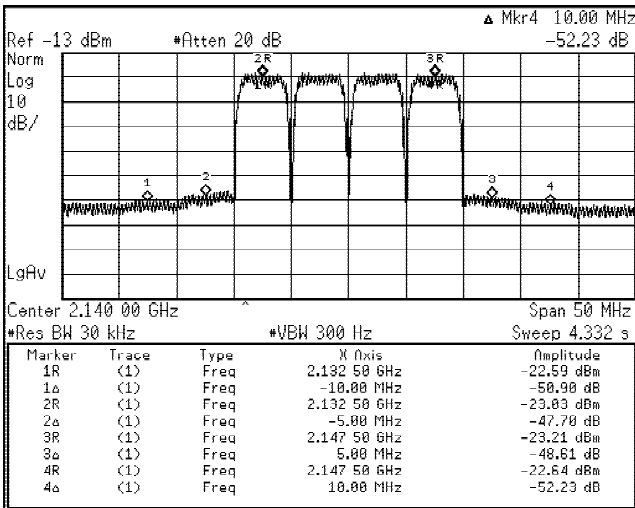

ACLR @5 dBm P_{OUT} for 4 FA WCDMA (KT ICOM)

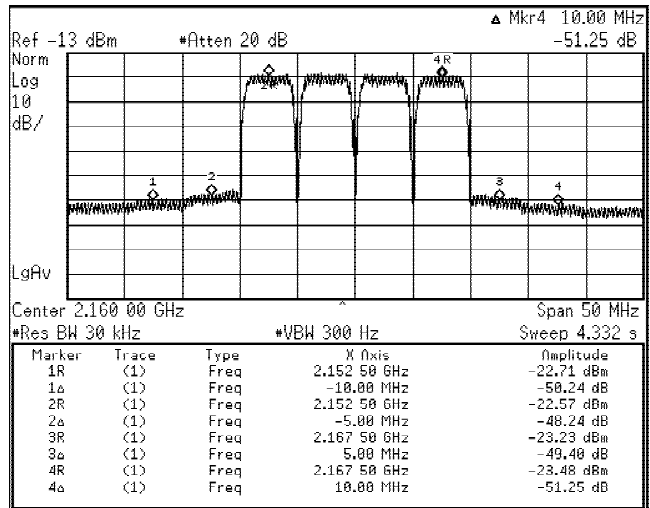

Gain, P1dB, and OIP3 with Temperature (-40°C ~ 100°C)

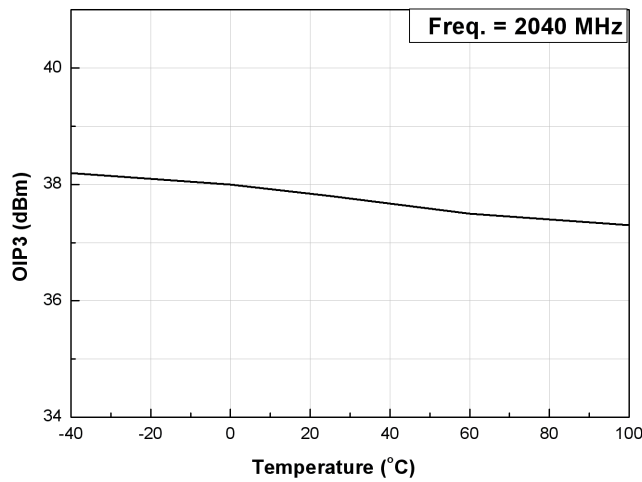
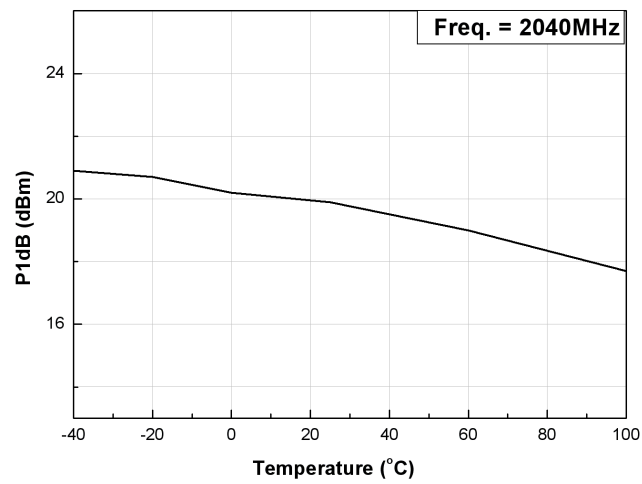
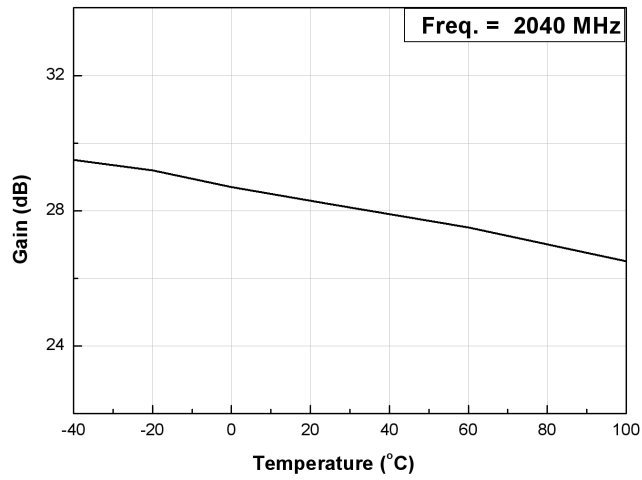

NF, P1dB, OIP3, and S-parameters with Voltage Change (4.5 V ~ 5.5 V)

Voltage (V)	Current (mA)	S21 (dB)			S11 (dB)			S22 (dB)			P1dB (dBm)	OIP3 (dBm)	NF (dB)	
		1920MHz	2040MHz	2170MHz	1920MHz	2040MHz	2170MHz	1920MHz	2040MHz	2170MHz				
4.5	71	27	27.5	26.8	-18.1	-13.7	-14.3	-15.4	-20.9	-16.1	18.6	37	0.73	
4.6	72	27	27.5	26.8	-18.5	-14	-14.6	-15.5	-21	-16	19.1	37.5	0.76	
4.7	74	27.1	27.6	26.9	-18.8	-14.1	-14.7	-15.3	-21	-16.2	19.2	38	0.74	
4.8	76	27.1	27.6	27	-19.2	-14.3	-14.9	-15.3	-21	-16.2	19.4	38.1	0.75	
4.9	78	27.2	27.7	27	-19.7	-14.4	-15	-15.1	-21.1	-16.3	19.6	38.5	0.74	
5	80	27.3	27.7	27	-20	-14.6	-15.2	-15.1	-21	-16.6	20	38.7	0.74	
5.1	82	27.3	27.8	27.1	-20.1	-14.9	-15.2	-15.1	-21	-16.4	20.1	39	0.75	
5.2	84	27.4	27.8	27.1	-20.6	-15	-15.4	-15	-21.1	-16.6	20.3	40	0.76	
5.3	86	27.4	27.9	27.2	-21	-15.1	-15.4	-15	-21.1	-16.6	20.5	39.7	0.76	
5.4	88	27.4	27.9	27.2	-21	-15.3	-15.6	-14.8	-21	-16.5	20.7	40	0.76	
5.5	90	27.5	27.9	27.2	-21.4	-15.4	-15.7	-14.8	-21	-16.7	20.9	40.2	0.75	
Variation	1	19	0.5	0.4	0.4	3.3	1.7	1.4	0.7	0.2	0.7	2.3	3.2	0.03

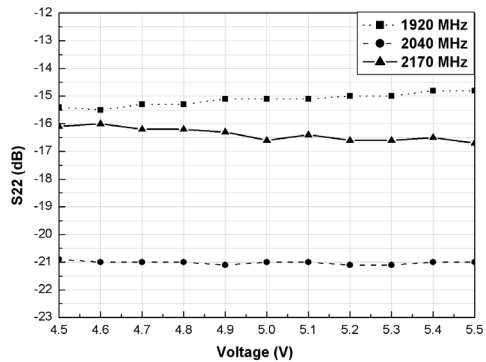
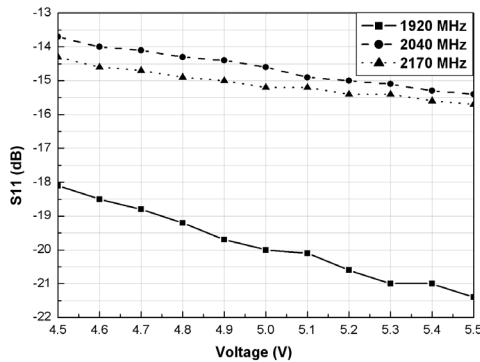
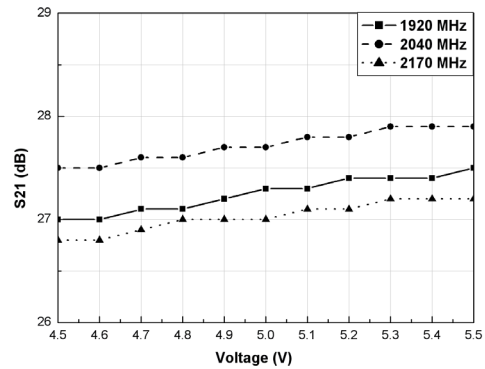
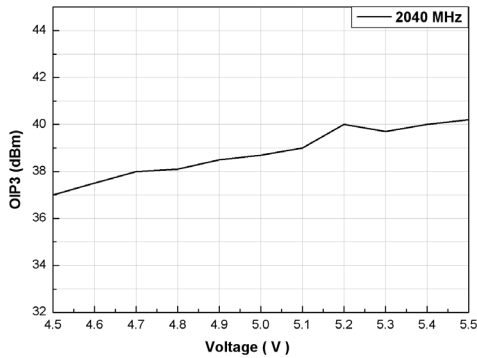
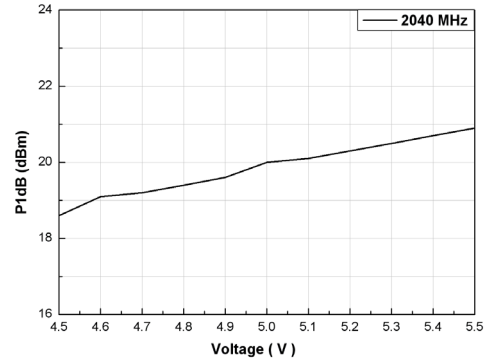
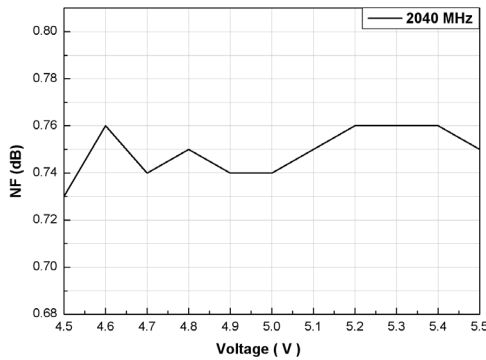

Recommended Soldering Reflow Process

