

A Brighter Solution

AMP DISPLAY INC.

SPECIFICATIONS

CUSTOMER	
CUSTOMER PART NO.	
AMP PART NO	AM-800480J1TMQW-A0H-F
APPROVED BY	
DATE	

Approved For Specifications

Approved For Specifications & Sample

AMP DISPLAY INC

9856 SIXTH STREET RANCHO CUCAMONGA CA 91730
TEL: 909-980-13410 FAX: 909-980-1419
WWW.AMPDISPLAY.COM

APPROVED BY	CHECKED BY	ORGANIZED BY

RECORD OF REVISION

Revision Date	Page	Contents	Editor
2010/9/13	-	New Release	Kevin

1. INSTRUCTION

Ampire 7" Display Module is a color active matrix TFT-LCD that uses amorphous silicon TFT as a switching device . This model is composed of a TFT-LCD panel , a driving circuit. This TFT-LCD has a high resolution (800(R.G.B) X 600) and can display up to 262,144 colors.

1.1 Features

- (1) Construction : a-Si TFT-LCD with driving system, White LED Backlight.
- (2) LCD type : Transmissive , Normally White
- (3) Number of the Colors : 262K colors (R,G,B 6 bit digital each)
- (4) LVDS Interface.
- (5) LCD Power Supply Voltage : 3.3V single power input, built-in power supply circuit.
 - SVGA (4:3 diagonal) configuration
 - Input interface voltage : 3.3V
- (6) **Reflective ratio 0.5% ~ 2%**

2. PHYSICAL SPECIFICATIONS

Item	Specifications	unit
Display resolution(dot)	800RGB (W) x 600(H)	dots
Active area	141.60 (W) x 106.20 (H)	mm
Pixel pitch	59 (W) x 177 (H)	um
Color configuration	R.G.B -stripe	
Overall dimension	154(W)x119.2(H)x8.1(D).	mm
Weight	152	g
Brightness	500nit	cd/m ²
Contrast ratio	250	
Backlight unit	LED	
Display color	262,144	colors

3. ABSOLUTE MAXIMUM RATINGS

Item	Symbol	Min.	Max.	Unit	Note
Supply voltage range	VCC	-0.5	4	V	(1)
Voltage range at any terminal	VI	-0.5	VCC + 0.5	V	
Operating Temperature	Top	-10	70	°C	
Storage Temperature	Tstg	-20	80	°C	

(1)All voltage values are with respect to the GND terminals unless otherwise noted.

4. OPTICAL CHARACTERISTICS

Item	Symbol	Conditon	Min.	Typ.	Max.	Unit	Note
Response Time	$T_r + T_f$	$\Theta = \Phi = 0^\circ$	-	16	--	ms	(1)
Contrast ratio	CR		--	250	-	-	(2)(3)
Viewing Angle	Vertical	$CR \geq 10$	--	120	-	Deg.	(5)
	Horizontal		Φ	--	140		
Luminance	L	$\Theta = \Phi = 0^\circ$	--	500	-	cd/m ²	(3)(4)
Luminance Uniformity	ΔL		-	70	-	%	(3)(4)
Color chromaticity	White		Wx	0.26	0.32	0.38	
		Wy	0.27	0.33	0.39		

NOTE :

- These items are measured by BM-5A(TOPCON) or CA-1000(MINOLTA) in the dark room (no ambient light)
- T.B.D means To be define.

(1) Definition of Response Time (White-Black)

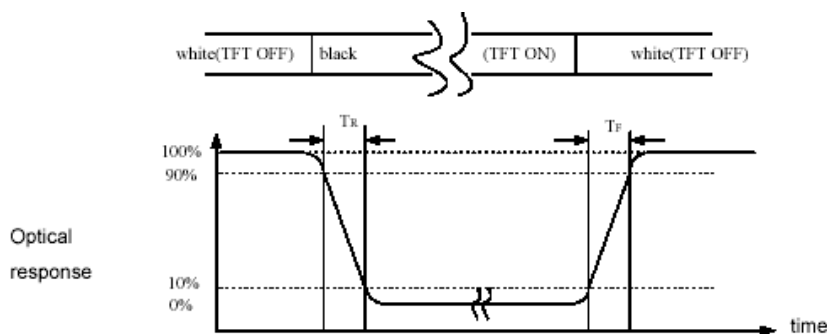

(2) Definition of Contrast Ratio

Measure contrast ratio on the below 5 points(refer to figure,#1~#5point) and take the average value

Contrast ratio is calculated with the following formula :

$$\text{Contrast Ratio(CR)} = (\text{White})\text{Luminance of ON} \div (\text{Black})\text{Luminance of OFF}$$

(3) Definition of Luminance :

Measured at the center area of the panel when all the input terminals of LCD panel are electrically opened.

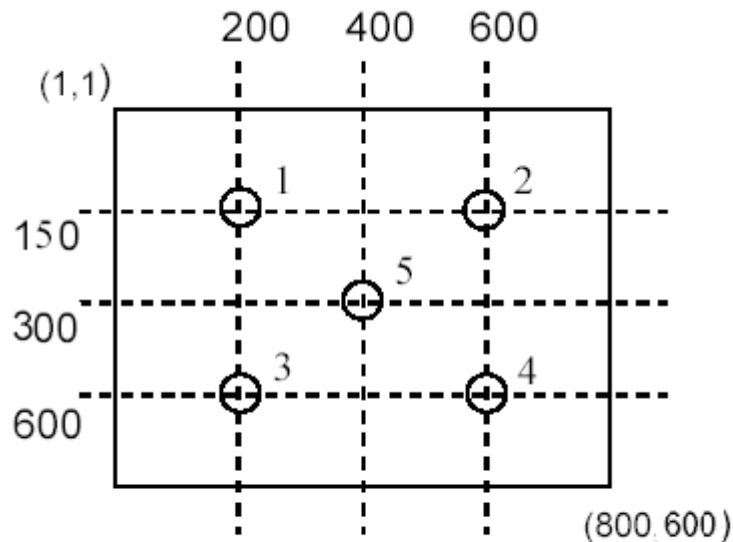

Fig.1 Measuring point

(4) Definition of Luminance Uniformity :

Measured Maximum luminance[L(MAX)] and Minimum luminance[L(MIN)] on the 5 points

Luminance Uniformity is calculated with the following formula :

$$\Delta L = [L(\text{MIN}) / L(\text{MAX})] \times 100\%$$

(5) Definition of Viewing Angle

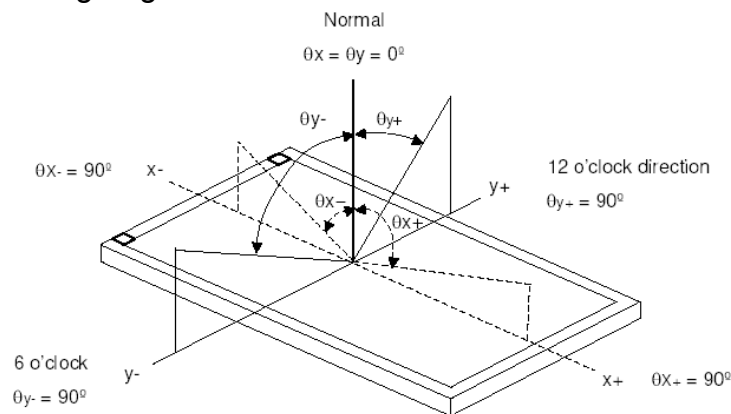

$$\Phi = (\Theta_{x+}) + (\Theta_{x-}) \quad \Theta = (\Theta_{y+}) + (\Theta_{y-})$$

5. ELECTRICAL CHARACTERISTICS

Recommended Operating Conditions

See Figure 2

		MIN	NOM	MAX	UNIT
V_{CC}	Supply voltage	3	3.3	3.6	V
V_{IH}	High-level input voltage (SHTDN)	2			V
V_{IL}	Low-level input voltage (SHTDN)			0.8	V
$ V_{ID} $	Magnitude differential input voltage	0.1		0.6	V
V_{IC}	Common-mode input voltage	$\frac{ V_{ID} }{2}$	$2.4 - \frac{ V_{ID} }{2}$		V
T_A	Operating free-air temperature	-40		125	°C

Timing Requirements

		MIN	NOM	MAX	UNIT
$t_c^{(1)}$	Cycle time, input clock	14.7	t_c	32.4	ns

(1) Parameter t_c is defined as the mean duration of a minimum of 32000 clock cycles.

PARAMETER MEASUREMENT INFORMATION

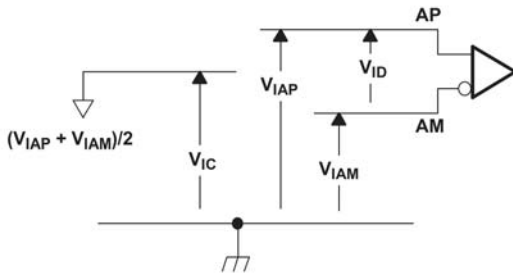

Figure 2. Voltage Definitions

6. Backlight unit

ITEM	SYMBOL	MIN	TYP	MAX	UNIT	NOTE
LED Voltage	VL	--	10.4	--	V	
LED Current	IL	--	200	--	mA	
Luminance	L	--	500	--	cd/m ²	
LED Life Time	Ta=25 °C		30K		Hr	Note1

Note 1 : Brightness to be decreased to 50% of the initial value.

7. INTERFACE

LVDS CN:

Pin no	Symbol	Function
1	VDD	POWER SUPPLY:3.3V
2	VDD	POWER SUPPLY:3.3V
3	Gnd	Power Ground
4	Gnd	Power Ground
5	IN0-	Transmission Data
6	IN0+	Transmission Data
7	Gnd	Power Ground
8	IN1-	Transmission Data
9	IN1+	Transmission Data
10	Gnd	Power Ground
11	IN2-	Transmission Data
12	IN2+	Transmission Data
13	Gnd	Power Ground
14	CLK-	Sampling Clock
15	CLK+	Sampling Clock
16	Gnd	Power Ground
17	NC	No Connect
18	NC	No Connect
19	Gnd	Power Ground
20	Gnd	Power Ground

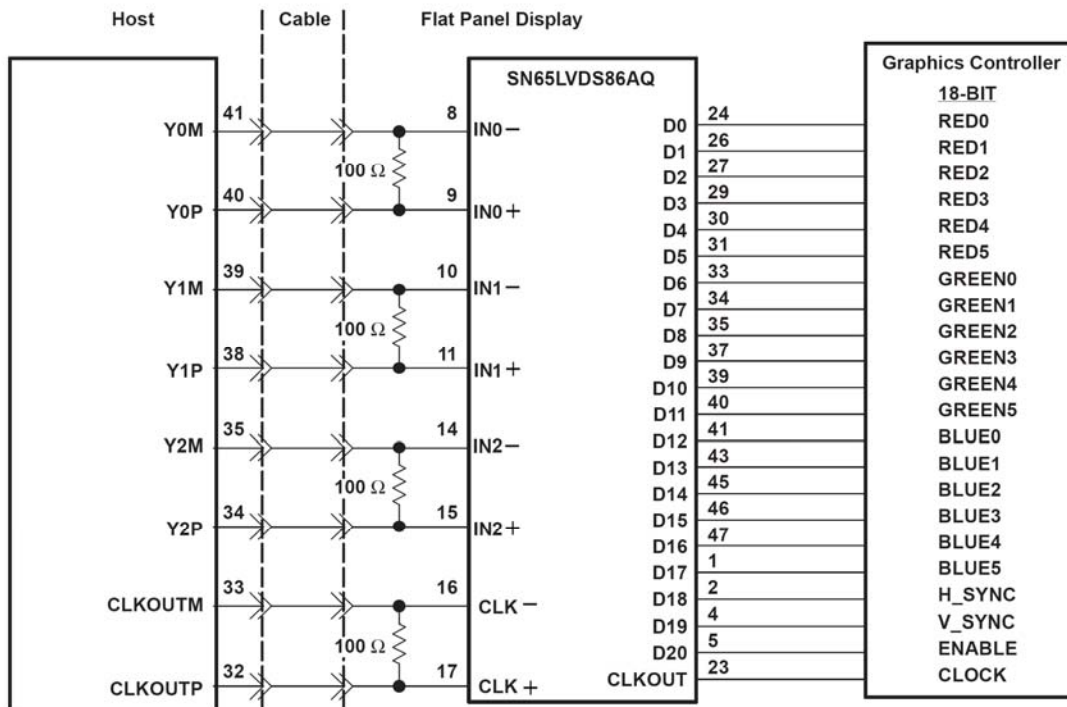

8. AC Timing characteristic of the LVDS

Switching Characteristics

over recommended operating conditions (unless otherwise noted)

PARAMETER	TEST CONDITIONS	MIN	TYP ⁽¹⁾	MAX	UNIT
t_{su} Setup time, D0–D20 to CLKOUT↓	$C_L = 8 \text{ pF}$, See Figure 5	5			ns
t_h Data hold time, CLKOUT↓ to D0–D20		5			ns
$t_{(RSKM)}$ Receiver input skew margin ⁽²⁾ (see Figure 7)	$t_c = 15.38 \text{ ns}$ ($\pm 0.2\%$), Input clock jitter < 50 ps, ⁽³⁾	550	700		ps
t_d Delay time, CLKIN↑ to CLKOUT↓ (see Figure 7)	$V_{CC} = 3.3 \text{ V}$, $t_c = 15.38 \text{ ns}$ ($\pm 0.2\%$), $T_A = 25^\circ\text{C}$	3	5	7	ns
t_{en} Enable time, $\overline{\text{SHTDN}}$ to phase lock	See Figure 7		1		ms
t_{dis} Disable time, $\overline{\text{SHTDN}}$ to off state	See Figure 8		400		ns
t_t Transition time, output (10% to 90% t_r or t_f) (data only)	$C_L = 8 \text{ pF}$		3		ns
t_t Transition time, output (10% to 90% t_r or t_f) (clock only)	$C_L = 8 \text{ pF}$		1.5		ns
t_w Pulse duration, output clock			$0.50 t_c$		ns

(1) All typical values are at $V_{CC} = 3.3 \text{ V}$, $T_A = 25^\circ\text{C}$.

(2) The parameter $t_{(RSKM)}$ is the timing margin available to allocate to the transmitter and interconnection skews and clock jitter. The value of this parameter at clock periods other than 15.38 ns can be calculated from $t_{RSKM} = t_c/14 - 550 \text{ ps}$.

(3) |Input clock jitter| is the magnitude of the change in input clock period.

PARAMETER MEASUREMENT INFORMATION (continued)

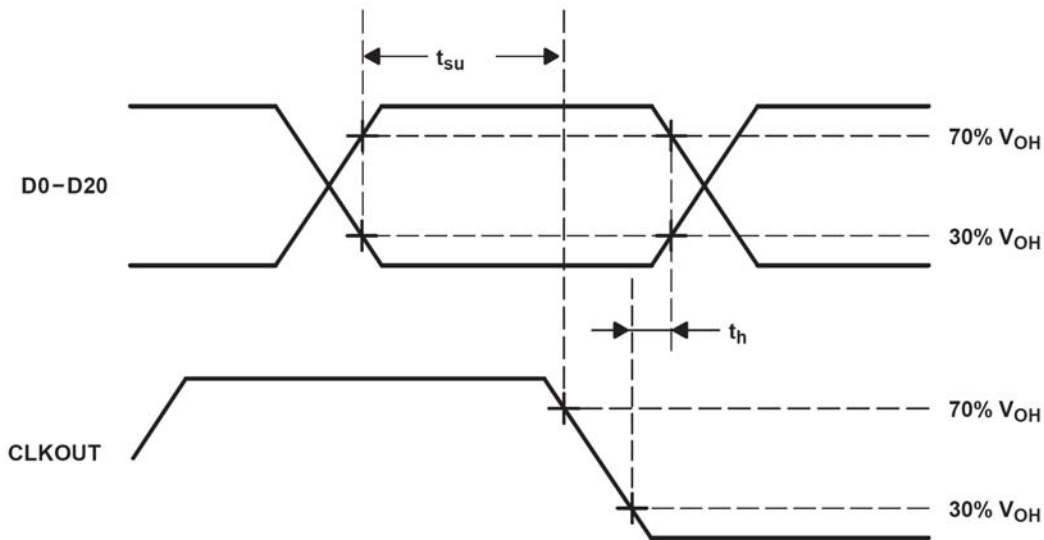

Figure 5. Setup and Hold Time Waveforms

PARAMETER MEASUREMENT INFORMATION (continued)

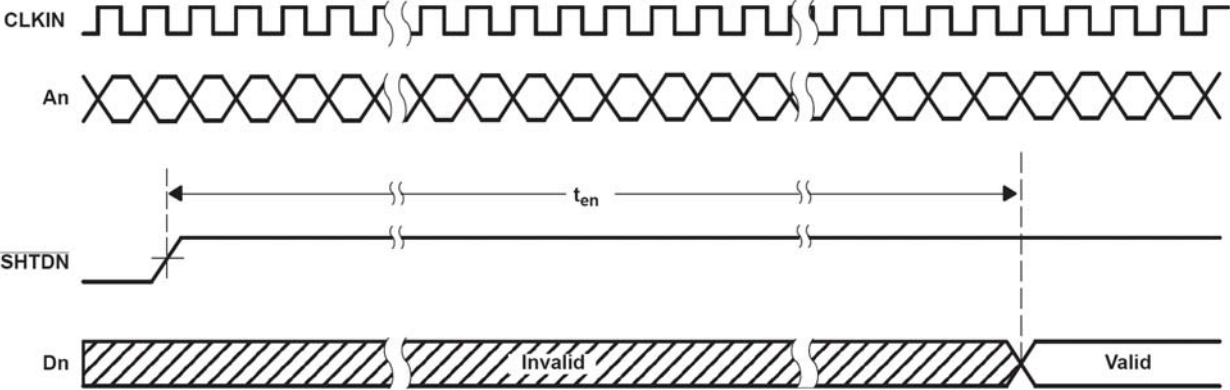

Figure 7. Enable Time Waveforms

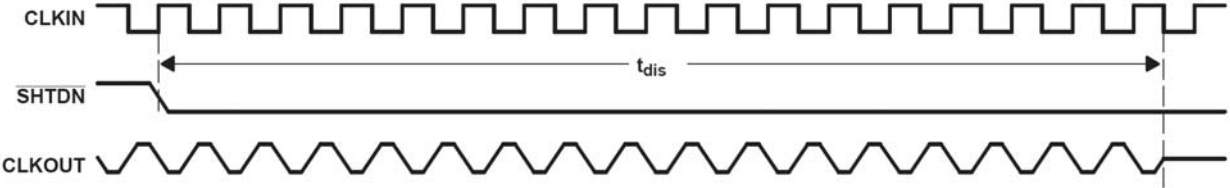

Figure 8. Disable Time Waveforms

9 . QUALITY AND RELIABILITY

9.1 TEST CONDITIONS

Tests should be conducted under the following conditions :

Ambient temperature : $25 \pm 5^{\circ}\text{C}$

Humidity : $60 \pm 25\% \text{ RH}$.

9.2 SAMPLING PLAN

Sampling method shall be in accordance with MIL-STD-105E , level II, normal single sampling plan .

9.3 ACCEPTABLE QUALITY LEVEL

A major defect is defined as one that could cause failure to or materially reduce the usability of the unit for its intended purpose. A minor defect is one that does not materially reduce the usability of the unit for its intended purpose or is an infringement from established standards and has no significant bearing on its effective use or operation.

9.4 APPEARANCE

An appearance test should be conducted by human sight at approximately 30 cm distance from the LCD module under florescent light. The inspection area of LCD panel shall be within the range of following limits.

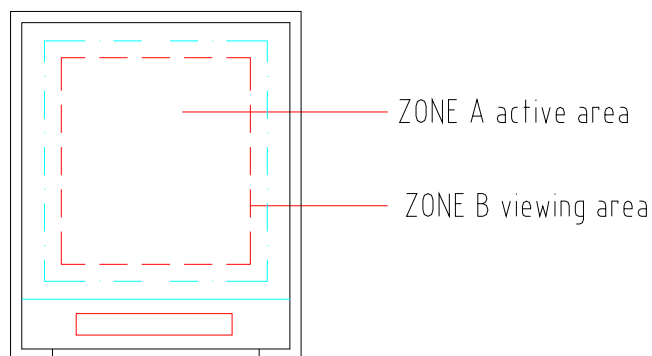

9.5 INCOMING INSPECTION STANDARD FOR TFT-LCD PANEL

DEFECT TYPE		LIMIT				Note		
VISUAL DEFECT	INTERNAL	SPOT	$\varphi < 0.15\text{mm}$		Ignore	Note1		
			$0.15\text{mm} \leq \varphi \leq 0.5\text{mm}$		$N \leq 4$			
			$0.5\text{mm} < \varphi$		$N=0$			
		FIBER	$0.03\text{mm} < W \leq 0.1\text{mm}, L \leq 5\text{mm}$		$N \leq 3$	Note1		
			$1.0\text{mm} < W, 1.5\text{mm} < L$		$N=0$			
		POLARIZER BUBBLE	$\varphi < 0.15\text{mm}$		Ignore	Note1		
	$0.15\text{mm} \leq \varphi \leq 0.5\text{mm}$		$N \leq 2$					
	$0.5\text{mm} < \varphi$		$N=0$					
Mura	It' OK if mura is slight visible through 6%ND filter							
ELECTRICAL DEFECT	BRIGHT DOT	A Grade			B Grade			
		C Area	O Area	Total	C Area	O Area	Total	Note3
		$N \leq 0$	$N \leq 2$	$N \leq 2$	$N \leq 2$	$N \leq 3$	$N \leq 5$	Note2
	DARK DOT	$N \leq 2$	$N \leq 3$	$N \leq 3$	$N \leq 3$	$N \leq 5$	$N \leq 8$	
	TOTAL DOT	$N \leq 4$			$N \leq 5$	$N \leq 6$	$N \leq 8$	Note2
	TWO ADJACENT DOT	$N \leq 0$	$N \leq 1$ pair	$N \leq 1$ pair	$N \leq 1$ pair	$N \leq 1$ pair	$N \leq 1$ pair	Note4
	THREE OR MORE ADJACENT DOT	NOT ALLOWED						
LINE DEFECT	NOT ALLOWED							

(1) One pixel consists of 3 sub-pixels, including R,G, and B dot.(Sub-pixel = Dot)

(2) LITTLE BRIGHT DOT ACCEPTABLE UNDER 6 % ND-Filter

[Note1] W : Width[mm], L : Length[mm], N : Number, φ : Average Diameter

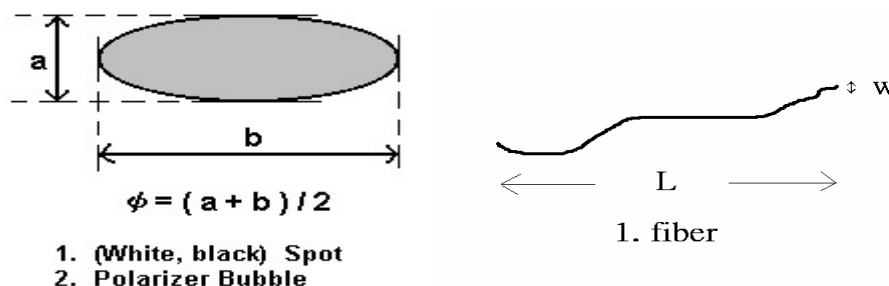

[Note2] Bright dot is defined through 6% transmission ND Filter as following.

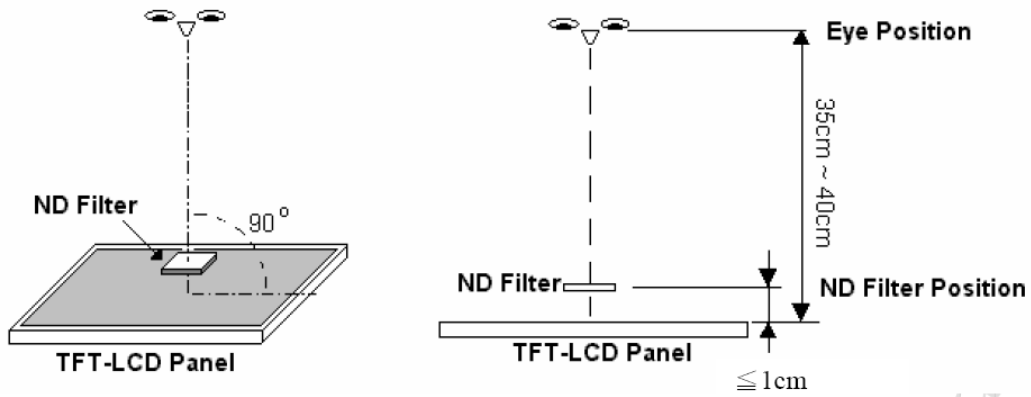

[Note3]

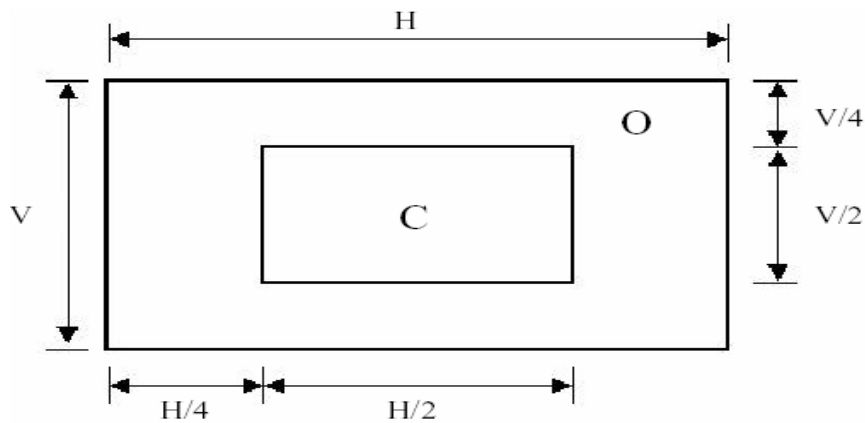

C Area: Center of display area

C Area: Outer of display area

[Note4]

Judge defect dot and adjacent dot as following. Allow below (as A, B, C and D status) adjacent defect dots, including bright and dark adjacent dot. And they will be counted 2 defect dots in total quantity.

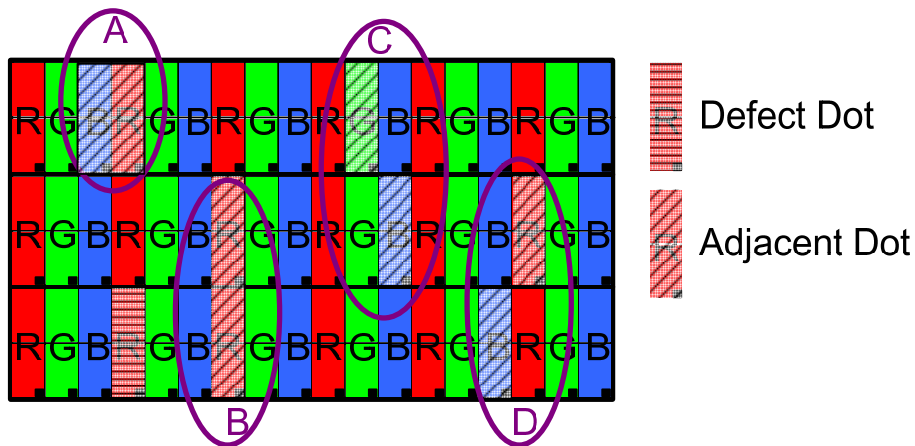

(1) The defects that are not defined above and considered to be problem shall be reviewed and discussed by both parties.

(2) Defects on the Black Matrix, out of Display area, are not considered as a defect or counted.

9.6 Reliability Test

Test Item	Test Conditions	Note
High Temperature Operation	70±3°C , t=96 hrs	
Low Temperature Operation	-10±3°C , t=96 hrs	
High Temperature Storage	80±3°C , t=96 hrs	1,2
Low Temperature Storage	-20±3°C , t=96 hrs	1,2
Thermal Shock Test	-10°C ~ 25 °C ~ 70 °C 30 m in. 5 min. 30 min. (1 cycle) Total 5 cycle	1,2
Humidity Test	40 °C, Humidity 90%, 96 hrs	1,2
Vibration Test (Packing)	Sweep frequency : 10 ~ 55 ~ 10 Hz/1min Amplitude : 0.75mm Test direction : X.Y.Z/3 axis Duration : 30min/each axis	2

Note 1 : Condensation of water is not permitted on the module.

Note 2 : The module should be inspected after 1 hour storage in normal conditions (15-35°C , 45-65%RH).

Definitions of life end point :

- Current drain should be smaller than the specific value.
- Function of the module should be maintained.
- Appearance and display quality should not have degraded noticeably.
- Contrast ratio should be greater than 50% of the initial value.

10. USE PRECAUTIONS

10.1 Handling precautions

- 1) The polarizing plate may break easily so be careful when handling it. Do not touch, press or rub it with a hard-material tool like tweezers.
- 2) Do not touch the polarizing plate surface with bare hands so as not to make it dirty. If the surface or other related part of the polarizing plate is dirty, soak a soft cotton cloth or chamois leather in benzene and wipe off with it. Do not use chemical liquids such as acetone, toluene and isopropyl alcohol. Failure to do so may bring chemical reaction phenomena and deteriorations.
- 3) Remove any spit or water immediately. If it is left for hours, the suffered part may deform or decolorize.
- 4) If the LCD element breaks and any LC stuff leaks, do not suck or lick it. Also if LC stuff is stuck on your skin or clothing, wash thoroughly with soap and water immediately.

10.2 Installing precautions

- 1) The PCB has many ICs that may be damaged easily by static electricity. To prevent breaking by static electricity from the human body and clothing, earth the human body properly using the high resistance and discharge static electricity during the operation. In this case, however, the resistance value should be approx. $1M\Omega$ and the resistance should be placed near the human body rather than the ground surface. When the indoor space is dry, static electricity may occur easily so be careful. We recommend the indoor space should be kept with humidity of 60% or more. When a soldering iron or other similar tool is used for assembly, be sure to earth it.
- 2) When installing the module and ICs, do not bend or twist them. Failure to do so may crack LC element and cause circuit failure.
- 3) To protect LC element, especially polarizing plate, use a transparent protective plate (e.g., acrylic plate, glass etc) for the product case.
- 4) Do not use an adhesive like a both-side adhesive tape to make LCD surface (polarizing plate) and product case stick together. Failure to do so may cause the polarizing plate to peel off.

10.3 Storage precautions

- 1) Avoid a high temperature and humidity area. Keep the temperature between 0°C and 35°C and also the humidity under 60%.
- 2) Choose the dark spaces where the product is not exposed to direct sunlight or fluorescent light.
- 3) Store the products as they are put in the boxes provided from us or in the same conditions as we recommend.

10.4 Operating precautions

- 1) Do not boost the applied drive voltage abnormally. Failure to do so may break ICs. When applying power voltage, check the electrical features beforehand and be careful. Always turn off the power to the LC module controller before removing or inserting the LC module input connector. If the input connector is removed or inserted while the power is turned on, the LC module internal circuit may break.
- 2) The display response may be late if the operating temperature is under the normal standard, and the display may be out of order if it is above the normal standard. But this is not a failure; this will be restored if it is within the normal standard.
- 3) The LCD contrast varies depending on the visual angle, ambient temperature, power voltage etc. Obtain the optimum contrast by adjusting the LC drive voltage.
- 4) When carrying out the test, do not take the module out of the low-temperature space suddenly. Failure to do so will cause the module condensing, leading to malfunctions.
- 5) Make certain that each signal noise level is within the standard (L level: 0.2V_{dd} or less and H level: 0.8V_{dd} or more) even if the module has functioned properly. If it is beyond the standard, the module may often malfunction. In addition, always connect the module when making noise level measurements.
- 6) The CMOS ICs are incorporated in the module and the pull-up and pull-down function is not adopted for the input so avoid putting the input signal open while the power is ON.
- 7) The characteristic of the semiconductor element changes when it is exposed to light emissions, therefore ICs on the LCD may malfunction if they receive light emissions. To prevent these malfunctions, design and assemble ICs so that they are shielded from light emissions.
- 8) Crosstalk occurs because of characteristics of the LCD. In general, crosstalk occurs when the regularized display is maintained. Also, crosstalk is affected by the LC drive voltage. Design the contents of the display, considering crosstalk.

10.5 Other

- 1) Do not disassemble or take the LC module into pieces. The LC modules once disassembled or taken into pieces are not the guarantee articles.
- 2) The residual image may exist if the same display pattern is shown for hours. This residual image, however, disappears when another display pattern is shown or the drive is interrupted and left for a while. But this is not a problem on reliability.
- 3) AMIPRE will provide one year warranty for all products and three months warrantee for all repairing products.

11. OUTLINE DIMENSION

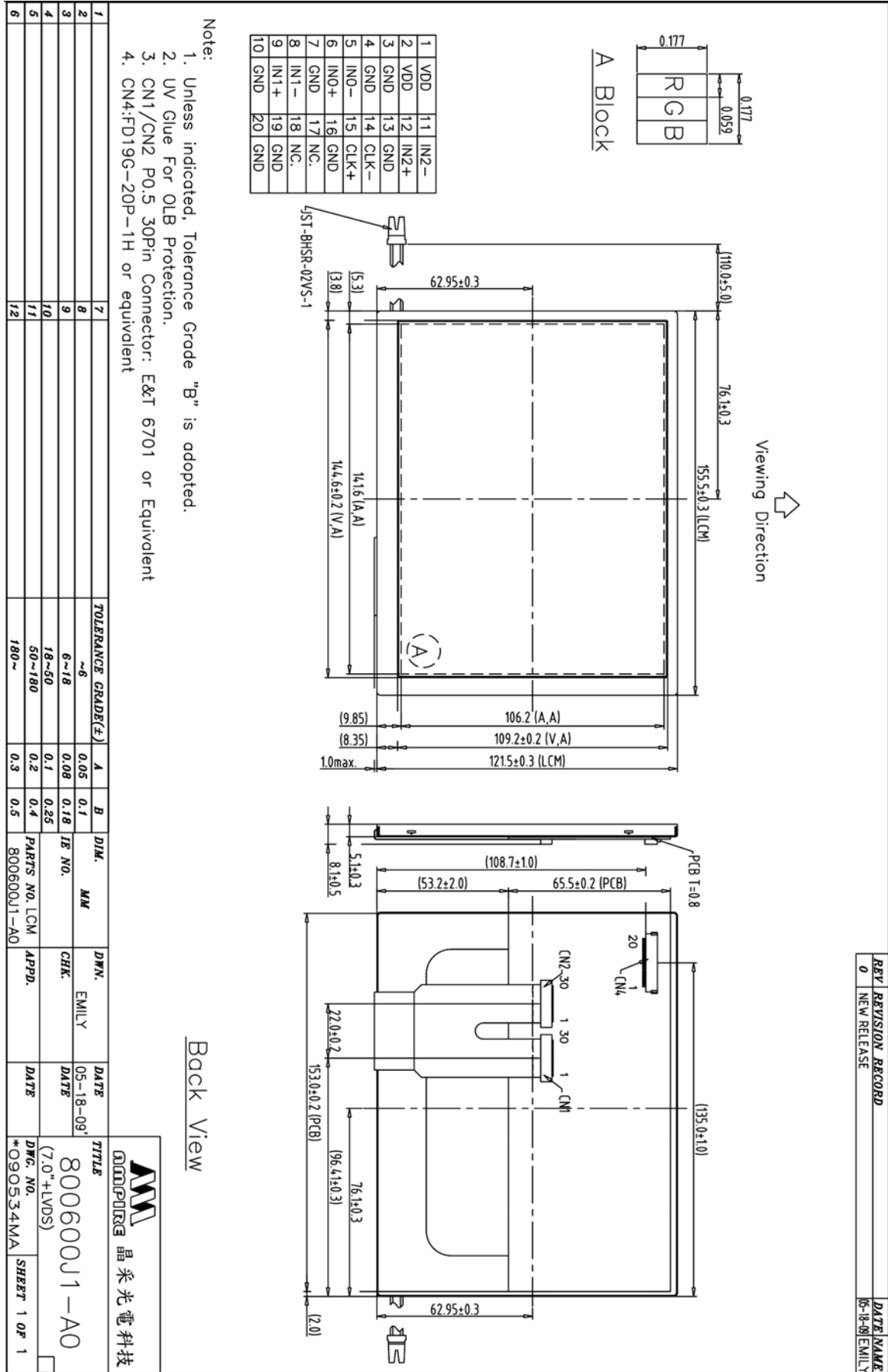

REV.	REVISION RECORD	DATE	NAME
0	NEW RELEASE	05-18-09	EMILY