



Your Total LCD Solution Provider

<http://www.orientdisplay.com>

**SPECIFICATION
FOR
LCD MODULE**

MODULE NO: AM0186R-08

REVISION NO: E00

Customer's Approval:

--

	SIGNATURE	DATE
PREPARED BY (RD ENGINEER)		
CHECKED BY		
APPROVED BY		

Table of Contents

1 General Specifications	3
2 Mechanical Diagram	4
3 I/O Terminal	6
3.1 Pin Description	6
3.2 Block Diagram	7
4. Electro-optical Specifications	8
4.1 Absolute Maximum Ratings	8
4.2 Optical Characteristics	8
4.3 Electrical Characteristics	8
4.4 Timing Characteristics	9
5 Programming.....	10
1 Packing Method.....	11
2 Classification.....	12
3 Definitions of Optical Characteristic.....	13
3.1 Contrast Ratio Test	13
3.2 Response time	13
3.3 Viewing Angle	14
4 Quality Units	15
4.1 Visual and Technological Inspection	15
4.2 Sampling Plan	15
5 Inspection Criteria.....	16
5.1 Appearance Criteria (Not energized)	16
6 Caution for using	19
7 Reliability-TEST	20
7.1. Standard Specifications for Reliability	20
7.2 Life Time:	20

Revision History

Rev.	Comment	Date
A00	Original Version	2011-03-11
C00	Add a backlight and modify the LCD&FPC.	2011-9-26
E00	Modify driver IC from C00.	2012-6-1

1 General Specifications

Item	<input checked="" type="checkbox"/> Standard Value	Unit
Display Pattern	<input checked="" type="checkbox"/> Graphic <input type="checkbox"/> _____ <input type="checkbox"/> Character <input type="checkbox"/> with ICON <input type="checkbox"/> Segment	
Color	<input checked="" type="checkbox"/> Mono. <input type="checkbox"/> Grayscale <input type="checkbox"/> _____	
Module Dimension (W x H x T)	54X43X2.9	mm
Viewing Area (W x H)	50X23	mm
Active Area (W x H)	47.361X21.489	mm
Character Size (W x H)	\	mm
Character Pitch (W x H)	\	mm
DOT Size (W x H)	0.153X0.153	mm
DOT Pitch (W x H)	0.168X0.168	mm
LCD Type	<input type="checkbox"/> TN, Positive <input type="checkbox"/> HTN, Positive <input type="checkbox"/> TN, Negative <input type="checkbox"/> HTN, Negative	
	<input type="checkbox"/> STN, Yellow-Green <input checked="" type="checkbox"/> FSTN, Positive <input type="checkbox"/> STN, Gray <input type="checkbox"/> STN, Blue <input type="checkbox"/> FSTN, Negative	
	<input type="checkbox"/> GDV <input type="checkbox"/> FM LCD <input type="checkbox"/> Color STN	
Polarizer Type	<input checked="" type="checkbox"/> Transflective <input type="checkbox"/> Transmissive <input type="checkbox"/> Reflective <input type="checkbox"/> Anti-Glare	
View Direction	<input checked="" type="checkbox"/> 6H <input type="checkbox"/> 12H <input type="checkbox"/> _____	
LCD Controller & Driver	ST7687A	
LCD Driving Method	1/128duty, 1/12bias	
Interface Type	Serial <input type="checkbox"/> I ² C <input checked="" type="checkbox"/> 4-line SPI <input type="checkbox"/> 3-line SPI <input type="checkbox"/> _____	
	Parallel <input type="checkbox"/> 6800 <input type="checkbox"/> 8080 <input type="checkbox"/> 4-bit <input type="checkbox"/> _____	
Backlight Type	<input checked="" type="checkbox"/> LED <input type="checkbox"/> Bottom <input checked="" type="checkbox"/> Single Side <input type="checkbox"/> Dual Side	
	<input type="checkbox"/> _____ <input type="checkbox"/> EL <input type="checkbox"/> CCFL	
Backlight Color	<input type="checkbox"/> Yellow-Green <input checked="" type="checkbox"/> White <input type="checkbox"/> Blue <input type="checkbox"/> Red <input type="checkbox"/> Amber <input type="checkbox"/> _____	
EL/CCFL Driver type	<input type="checkbox"/> Build-in <input type="checkbox"/> External	
DC-DC Converter	<input checked="" type="checkbox"/> Build-in <input type="checkbox"/> External	
Operation Temperature	T _{OPL} = -10 T _{OPH} = +60	°C
Storage Temperature	T _{STL} = -20 T _{STH} = +70	°C

2 Mechanical Diagram

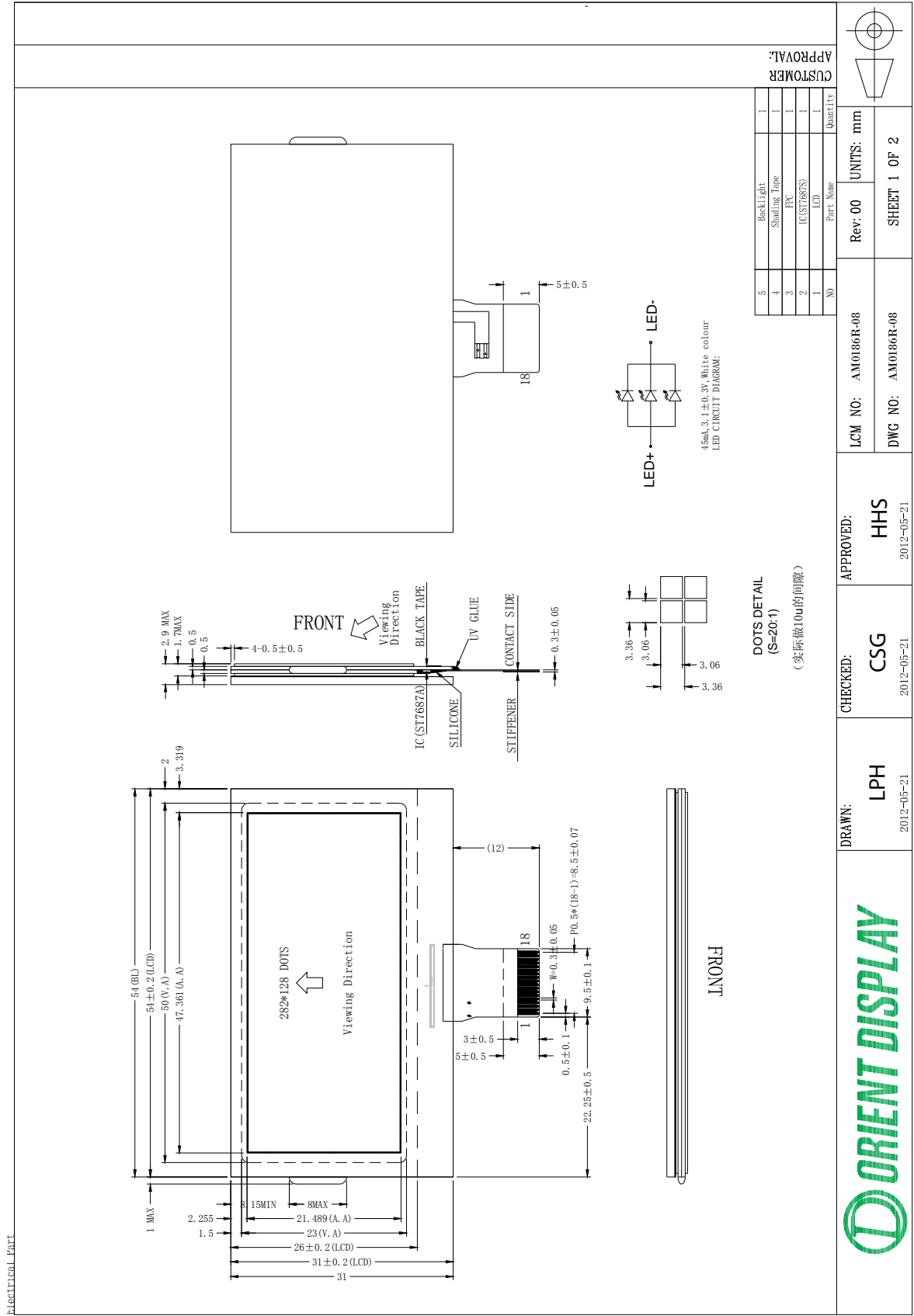

Electrical Part

Block Diagram:

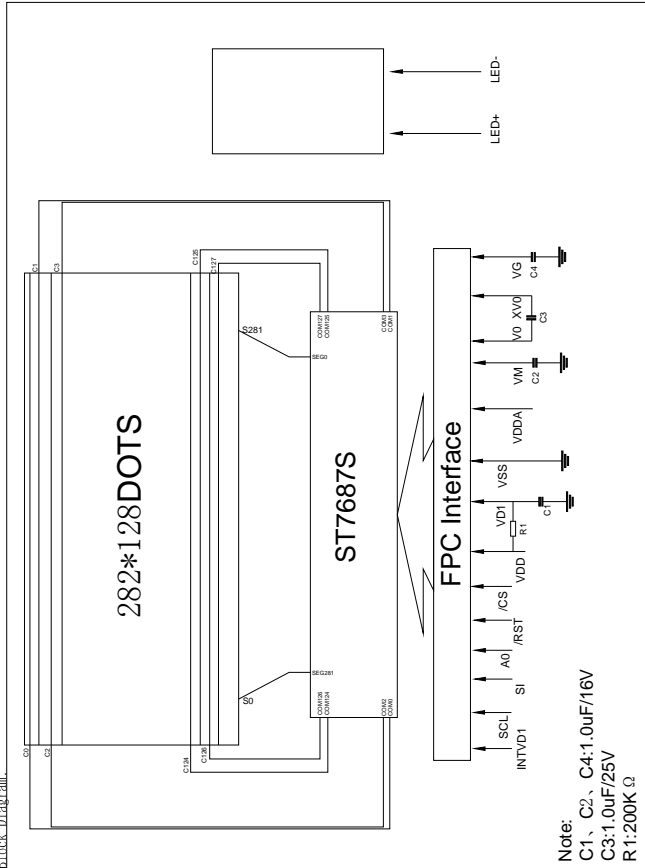

Note:
 C1, C2, C4:1.0uF/16V
 C3:1.0uF/25V
 R1:200K Ω

DISPLAY TYPE: FSTN, Transflective, Positive
 VIEWING DIRECTION: 6:00
 DRIVER IC: ST7687S (4-wire SPI)
 LOGIC VOLTAGE (VDD): 1.8~3.0V, INTVD1=VSS
 3.0~3.3V, INTVD1=VDD
 ANALOG VOLTAGE (VDDA): 3.3V
 LCD DRIVE VOLTAGE (V1cd): 16V
 DRIVING METHOD: 1/128 DUTY, 1/12 BIAS
 OPERATING TEMPERATURE: -10° ~ +60° C
 STORAGE TEMPERATURE: -20° ~ +70° C
 INTERFACE CONNECTOR: FPC
 ALL UNMARKED TOLERANCE: ±0.3mm

Pin Description: (4-wire SPI)

Pin	Symbol	Function Description
1	LED+	Anode for backlight circuit.
2	ESD1	ESD pad, connect to ground.
3	INTVD1	When VDD=1.8~3.0V, INTVD1=VSS. When VDD=3.0~3.3V, INTVD1=VDD.
4	SCL	Serial clock.
5	SI	Serial data input.
6	A0	Data/Command select.
7	/RST	Reset. (Active low)
8	/CS	Chip select. (Active low)
9	VDD	Digital power input
10	VDI	Voltage regulator for digital circuit.
11	VSS	Power ground.
12	VDDA	Analog power input.
13	VM	I/O pin of LCD bias supply voltages.
14	V0	LCD driver supply voltages.
15	XV0	Bias driver supply voltages.
16	VG	Bias driver supply voltages.
17	ESD2	ESD pad, connect to ground.
18	LED-	Cathode for backlight circuit.

C05:Modify the IC.
 C04:Modify the FPC interface.
 C03:Modify the display type and the FPC layout logic.
 C02:Modify FPC.
 C01:Update the drawing.
 C00:Add a Backlight, Modify the Thickness of Glass.
 B00:Modify the driver IC.
 A05:Modify the ITO layout.
 A04:Modify the FPC layout and update the drawing.
 A03:Modify the FPC layout and update the drawing.
 A02:Modify the driver IC and update the drawing.
 A01:Add component on the FPC & modify the FPC Logic.
 A00: Original Edition
 Revision History:

DRAWN:
 YXH
 2011-06-08

CHECKED:
 WYH
 2011-06-08

APPROVED:
 HHS
 2011-06-08

LCM NO: AM0186R-08
 DWG NO: AM0186R-08

Rev: 05
 UNITS: mm
 SHEET 2 OF 2

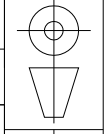

3 I/O Terminal

3.1 Pin Description

PIN	Symbol	Function Description
1	LED+	Anode for backlight circuit.
2	ESD1	ESD pad, connect to ground.
3	INTVD1	When VDD=1.8~3.0V, INTVD1=VSS. When VDD=3.0~3.3V, INTVD1=VDD.
4	SCL	Serial clock.
5	SI	Serial data input.
6	A0	Data/Command select.
7	/RST	Reset. (Active low)
8	/CS	Chip select. (Active low)
9	VDD	Digital power input
10	VD1	Voltage regulator for digital circuit.
11	VSS	Power ground.
12	VDDA	Analog power input.
13	VM	I/O pin of LCD bias supply voltages.
14	V0	LCD driver supply voltages.
15	XV0	
16	VG	Bias driver supply voltages.
17	ESD2	ESD pad, connect to ground.
18	LED-	Cathode for backlight circuit.

3.2 Block Diagram

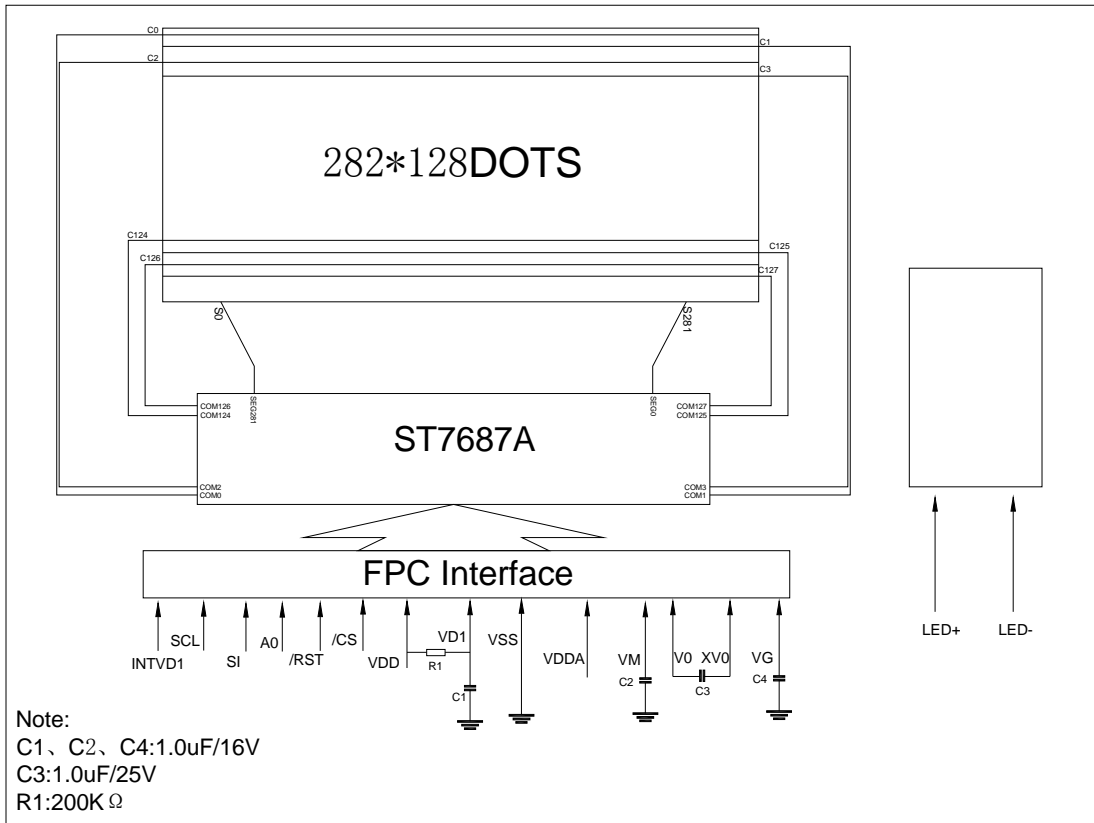

4. Electro-optical Specifications

4.1 Absolute Maximum Ratings

No	Item	Symbol	Min.	Max.	Unit
1	DC Supply Voltage	V _{DD} -V _{SS}	-0.3	+3.6	V
2	Supply Voltage For LCD Driver	V ₀	-0.3	+18.0	V
3	Input Voltage	V _I	V _{SS} -0.3	V _{DD} +0.3	V

Note: Operating Temperature and Storage Temperature can be found in 1. General Specifications.

4.2 Optical Characteristics⁽¹⁾

No	Item	Symbol	Condition	Min.	Typ.	Max.	Unit
1	Contrast Ratio	Cr	Ta=23±3°C V _{LCD} = Typ. ⁽²⁾	-	3.5	-	-
2	Response time	T _{ON}	Ta=23±3°C	-	217	-	ms
3	Response time	T _{OFF}	Ta=23±3°C	-	162	-	ms
4	Viewing Angle	3H	Cr = 2 Ta=23±3°C	33	-	-	Deg.
5		9H		37	-	-	Deg.
6		6H		35	-	-	Deg.
7		12H		28	-	-	Deg.
8	Backlight	Luminous	Lv	Ta=25°C If=45mA	350	500	cd/m ²

Note:

(1) See Appendix Definition of Optical Characteristics for detail.

(2) V_{LCD} can be found in 4.3 Electrical Characteristics *Supply Voltage for LCD Driver*

4.3 Electrical Characteristics

No	Item	Symbol	Condition	Min.	Typ.	Max.	Unit
1	Supply Voltage for Logic	VDD	INTVD1=VSS	2.0	-	3.3	V
			INTVD1=VDD	3.0	-	3.3	
2	Supply Voltage for analog	VDDA	-	-	-	3.3	V
3	Supply Voltage for LCD Driver	V _{LCD}	Ta=23±3°C	-	16	-	V
4	Frame Frequency	F _M	Ta=23±3°C	-	77	-	Hz
5	High-level input Voltage	V _{OHC}	-	0.8VDD	-	VDD	V
6	Low-level input Voltage	V _{OLC}	-	VSS	-	0.2VDD	V
7	Backlight Forward Voltage	V _f	If=45mA	2.9	3.1	3.3	V
8	Backlight Forward Current	If	-	-	45	-	mA

4.4 Timing Characteristics⁽¹⁾

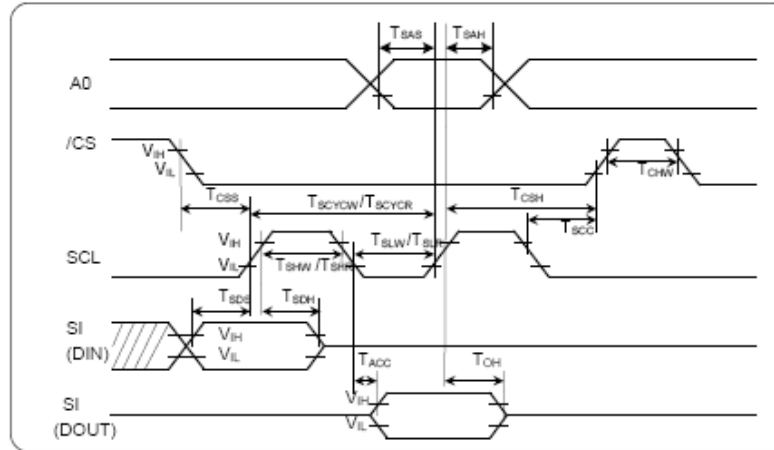

($V_{DDA}=2.4$ to $3.3V$, $V_{DDI}=1.65$ to $3.3V$, $T_a= 25^\circ C$, die)

Item	Signal	Symbol	Condition	Rating		Units
				Min.	Max.	
Serial clock period (write)	SCL	T_{SCYCW}		70	—	ns
SCL "H" pulse width (write)		T_{SHW}		35	—	
SCL "L" pulse width (write)		T_{SLW}		35	—	
Serial clock period (read)		T_{SCYCR}		150	—	
SCL "H" pulse width (read)		T_{SHR}		70	—	
SCL "L" pulse width (read)		T_{SLR}		70	—	
Address setup time	A0	T_{SAS}		10	—	
Address hold time		T_{SAH}		10	—	
Data setup time	SI	T_{SDS}		10	—	
Data hold time		T_{SDH}		10	—	
Data access time		T_{ACC}	CL = 30 pF	—	60	
Output disable time		T_{OH}	CL = 30 pF	—	60	
Chip select setup time	/CS	T_{CSS}		35	—	
Chip select hold time		T_{CSH}		35	—	
Chip select "H" pulse width		T_{CHW}		0	—	

*1 The input signal rise and fall time (T_r , T_f) are specified at 15 ns or less.

*2 All timing is specified using 20% and 80% of VDD as the standard.

NOTE:

(1) See Datasheet of LCD Driver for detail.

5 Programming⁽¹⁾

NOTE:

(1)See Datasheet of LCD Driver for detail.

1 Packing Method (TBD)

□ Method 1

ESD Bag + Product Box + Plastic Bag + Carton

1. Quantity

QUANTITY	UNIT
	PCS / ESD Bag
	PCS / Box
	Box / Carton
	PCS / Carton

2. Material

Material	Size (LXWXH) mm
ESD Bag	
Product Box	
Carton	

3. Label

PRODUCT ID:
PART NO:
QUANTITY:
GROSS WEIGHT:
MEASUREMENTS:

4. Packing Method

Note: see *table 1. Quantity* for detail.

□ Method 2

ESD Tray + Plastic Bag + Carton

1. Quantity

QUANTITY	UNIT
	PCS / Tray
	Tray / Carton
	PCS / Carton

2. Material

Material	Size (LXWXH) mm
ESD Tray	
Carton	

3. Label

PRODUCT ID:
PART NO:
QUANTITY:
GROSS WEIGHT:
MEASUREMENTS:

4. Packing Method

Note: see *table 1. Quantity* for detail.

Note:

AM0186R-08

Page 11

2 Classification

A M C 1 6 0 2 A R - B - B 6 W T D W - S P
 1 2 3 4 5 6 7 8 9 10 11 12 13

1	Brand : Orient Display (N.A.) Ltd.
2	Display Type : C→ Character Type, G→ Graphic Type, NONE→ Custom-made
3	Display Font : Characters X Lines / Rows X Columns /Others
4	Model serials no.
5	RoHS compliant: R→YES NONE→ NO
6	IC Package Type: M→ SMT Type B→ COB Type T→ TAB Type G→ COG Type F→ COF Type S→ Special
7	LCD Mode: P→TN Positive N→TN Negative Y→ STN Positive, Yellow Green B→ STN Negative, Blue G→ STN Positive, Gray W→ FSTN Positive T→ FSTN Negative F→ FFSTN Negative S→ Special
8	Viewing direction 6→ 6:00,12→12:00, S→Special
9	Temperature range N → Normal Temperature W→ Wide Temperature S→ Special
10	LCD Polarizer Type R→ Reflective T→ Transmissive F→ Transflective S→ Special
11	Backlight Type N→ None D→ LED E→ EL F→ CCFL S→ Special
12	Backlight Color Y→ Yellow-green B→ Blue A→ Amber W→ White G→ Green R→ Red S→ Special
13	Internal Code

3 Definitions of Optical Characteristic

3.1 Contrast Ratio Test

A) Contrast ratio is calculated by the following formula when the output voltage is obtained from the electro-optical test system.

B) Test Condition: Accord to the LCD's driving method and operating voltage (V_{LCD}).

C) Formula:

$$\text{Contrast Ratio (Positive type)} = \frac{\text{Photometer output voltage when non select waveform is applying}}{\text{Photometer output voltage when select waveform is applying}}$$

$$\text{Contrast Ratio (Negative type)} = \frac{\text{Photometer output voltage when select waveform is applying}}{\text{Photometer output voltage when non select waveform is applying}}$$

D) Test system:

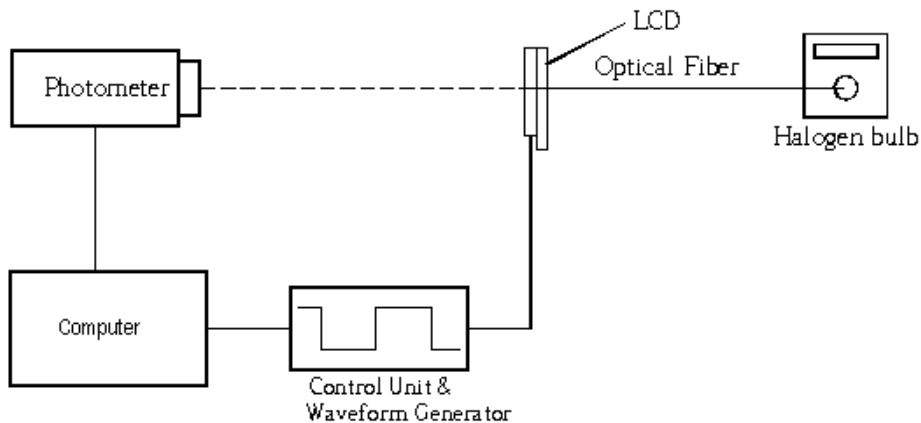

3.2 Response time

3.2.1 Positive type

A) Rise time is defined as the time required for the transmission to change from 90% to 10%.

B) Fall time is defined as the time required for the transmission to change from 10% to 90%.

C) On time is defined as the time required for the transmission to change from 100% to 10%.

D) Off time is defined as the time required for the transmission to change from 0% to 90%.

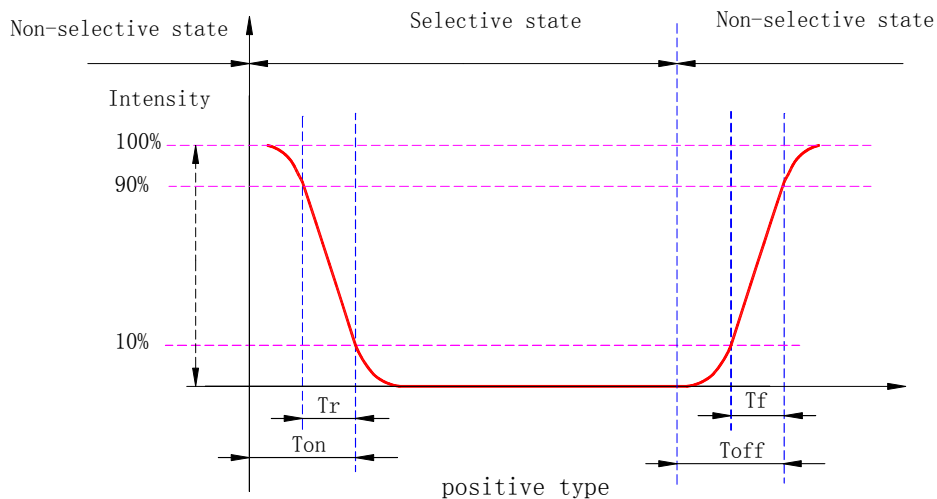

3.2.2 Negative type

- A) Rise time is defined as the time required for the transmission to change from 10% to 90%.
- B) Fall time is defined as the time required for the transmission to change from 90% to 10%.
- C) On time is defined as the time required for the transmission to change from 0% to 90%.
- D) Off time is defined as the time required for the transmission to change from 100% to 10%.

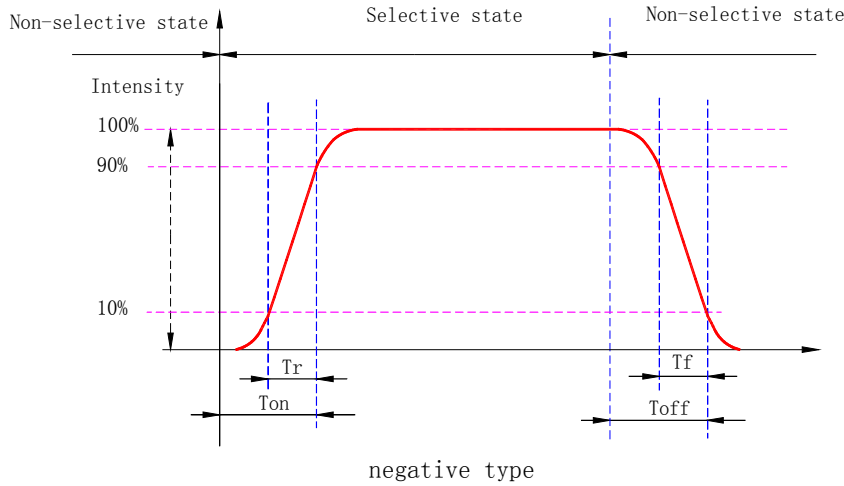

3.3 Viewing Angle

- A) Viewing angle is definition

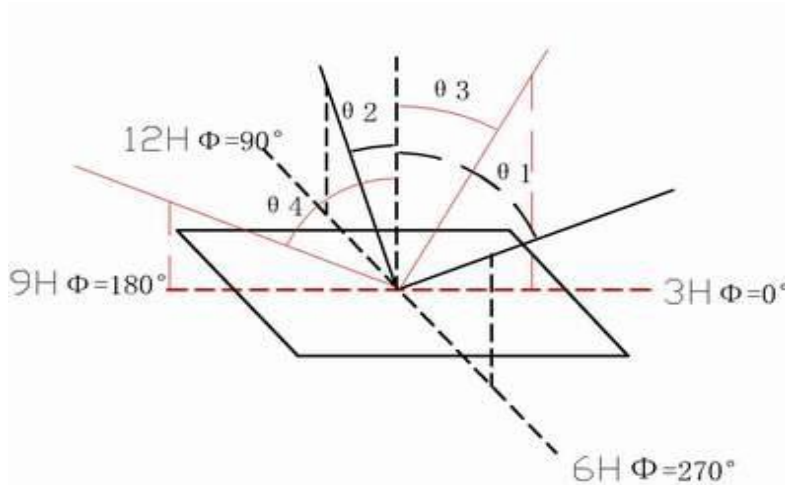

- B) System Block Diagram

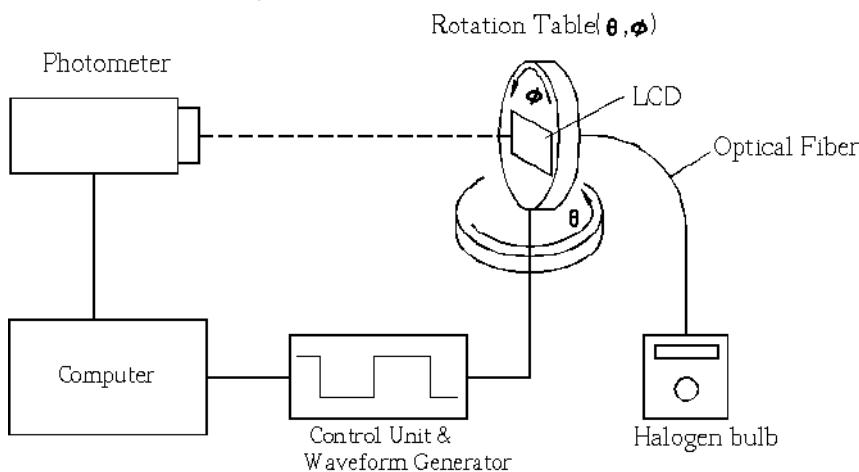

4 Quality Units

4.1 Visual and Technological Inspection

- Inspection direction should be perpendicular to LCD surface;
- Inspection should be performed under the condition of 20~40W fluorescent lamp;
- The distance between inspector's eyes & product surface should be 30cm~50cm when inspection.

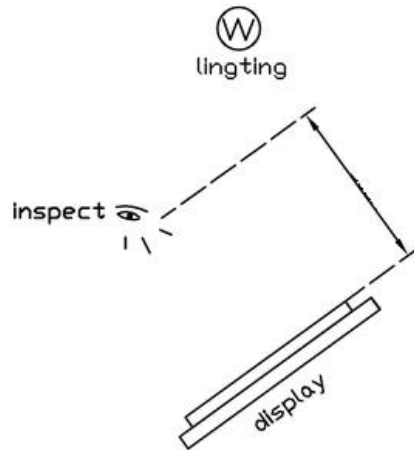

Definition of LCD area

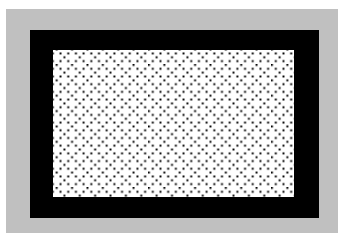

A: Active Area



B: Viewing Area



C: Invisible Area (It is invisible after assembly; any defects in this area should be ignored.)

4.2 Sampling Plan

4.2.1 Sampling Method

According to GB2828.1-2003 (Equivalent to MIL-STD-105/E) General inspection level II.

4.2.2 AQL Definition

Major: AQL=0.65 (Please refer to the definition in "5. Inspection Criteria")

Minor: AQL=1.0 (Please refer to the definition in "5. Inspection Criteria")

5 Inspection Criteria

5.1 Appearance Criteria (Not energized)

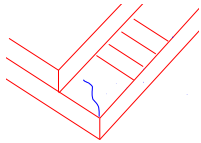
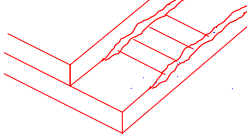
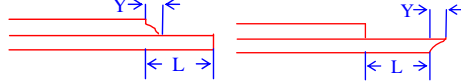
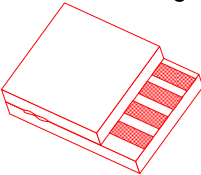
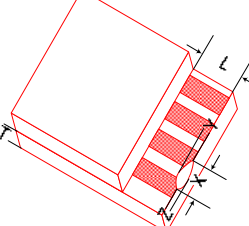
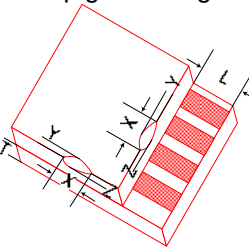
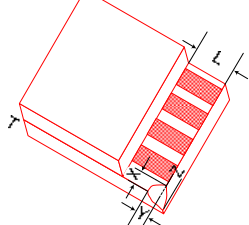
NO.	Defect Name & Illustration	Criteria	Class																
5.1.1	Liquid Crystal Leakage	Not allowed	Major																
5.1.2	Bubble in Liquid Crystal	Not allowed	Major																
5.1.3	Rainbow	According to Limit Sample	Minor																
5.1.4	Glass Crack 	Not allowed	Minor																
5.1.5	Protrusion - ITO lead 	 $Y \leq L/4$, allowed quantity:2	Minor																
5.1.6	Protrusion - Edge 	Allowed if protrusion didn't affect dimension.	Minor																
5.1.7	Chip glass - ITO Lead 	Unit: mm <table border="1"> <thead> <tr> <th>X</th> <th>Y</th> <th>Z</th> <th>Allowed Qty.</th> </tr> </thead> <tbody> <tr> <td>Random</td> <td>≤ 0.5, if $L/3 > 0.5$</td> <td>$\leq T/2$</td> <td>NC¹</td> </tr> <tr> <td>≤ 4.0</td> <td>$\leq L/3$</td> <td>$\leq T$</td> <td>3</td> </tr> </tbody> </table>	X	Y	Z	Allowed Qty.	Random	≤ 0.5 , if $L/3 > 0.5$	$\leq T/2$	NC ¹	≤ 4.0	$\leq L/3$	$\leq T$	3	Minor				
X	Y	Z	Allowed Qty.																
Random	≤ 0.5 , if $L/3 > 0.5$	$\leq T/2$	NC ¹																
≤ 4.0	$\leq L/3$	$\leq T$	3																
5.1.8	Chip glass - Edge 	Unit: mm <table border="1"> <thead> <tr> <th>X</th> <th>Y*</th> <th>Z</th> <th>Allowed Qty.</th> </tr> </thead> <tbody> <tr> <td>Random</td> <td>≤ 1.5, if $L/3 > 1.5$</td> <td>$\leq T/2$</td> <td>NC</td> </tr> <tr> <td>≤ 5.0</td> <td>≤ 1.5</td> <td>$\leq T$</td> <td>3</td> </tr> <tr> <td>Random</td> <td>≤ 0.5</td> <td>$\leq T/2$</td> <td>NC</td> </tr> </tbody> </table> Remark: Y didn't reach A area & 1/3 seal line.	X	Y*	Z	Allowed Qty.	Random	≤ 1.5 , if $L/3 > 1.5$	$\leq T/2$	NC	≤ 5.0	≤ 1.5	$\leq T$	3	Random	≤ 0.5	$\leq T/2$	NC	Minor
X	Y*	Z	Allowed Qty.																
Random	≤ 1.5 , if $L/3 > 1.5$	$\leq T/2$	NC																
≤ 5.0	≤ 1.5	$\leq T$	3																
Random	≤ 0.5	$\leq T/2$	NC																
5.1.9	Chip glass - Corner 	Unit: mm <table border="1"> <thead> <tr> <th>X</th> <th>Y</th> <th>Z</th> <th>Allowed Qty.</th> </tr> </thead> <tbody> <tr> <td>≤ 4</td> <td>$\leq L$</td> <td>$\leq T$</td> <td>2</td> </tr> </tbody> </table> Remark: If X reach ITO lead, according to the criteria of "5.1.7".	X	Y	Z	Allowed Qty.	≤ 4	$\leq L$	$\leq T$	2	Minor								
X	Y	Z	Allowed Qty.																
≤ 4	$\leq L$	$\leq T$	2																

¹ NC = Not Count

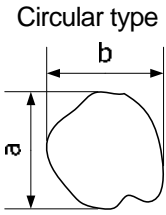
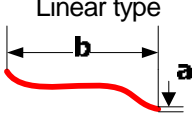
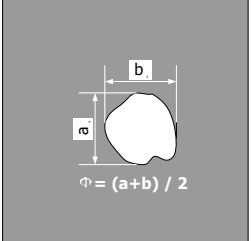
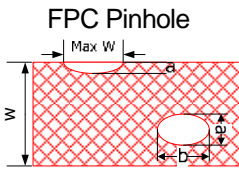
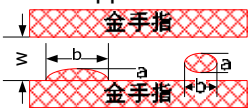
5.1.10	<p>Circular type</p>  <p>$\Phi = (a+b) / 2$</p>	<p>Suppose S^2= The area of A, the criteria in A&B is as below,</p> <table border="1" data-bbox="592 197 1353 432"> <thead> <tr> <th>S (cm²) \ Φ (mm)</th> <th>$S \leq 4$</th> <th>$4 < S \leq 12$</th> <th>$12 < S \leq 50$</th> <th>$50 < S \leq 150$</th> <th>$S > 150$</th> </tr> </thead> <tbody> <tr> <td>$\Phi \leq 0.10$</td> <td>NC</td> <td>NC</td> <td>NC</td> <td>NC</td> <td>NC</td> </tr> <tr> <td>$0.10 < \Phi \leq 0.20$</td> <td>1</td> <td>2</td> <td>2</td> <td>3</td> <td>3</td> </tr> <tr> <td>$0.20 < \Phi \leq 0.30$</td> <td>1</td> <td>1</td> <td>2</td> <td>2</td> <td>3</td> </tr> <tr> <td>$\Phi > 0.30$</td> <td>0</td> <td>0</td> <td>0</td> <td>0</td> <td>0</td> </tr> </tbody> </table> <p>Remark: Bubble, dirt spot, concavo-convex spot & stab spot should be regarded as circular defect. Maximum defect number in 1cm² is 1. Please refer to footmark for the conversion between S & Diagonal.</p>	S (cm ²) \ Φ (mm)	$S \leq 4$	$4 < S \leq 12$	$12 < S \leq 50$	$50 < S \leq 150$	$S > 150$	$\Phi \leq 0.10$	NC	NC	NC	NC	NC	$0.10 < \Phi \leq 0.20$	1	2	2	3	3	$0.20 < \Phi \leq 0.30$	1	1	2	2	3	$\Phi > 0.30$	0	0	0	0	0	Minor
S (cm ²) \ Φ (mm)	$S \leq 4$	$4 < S \leq 12$	$12 < S \leq 50$	$50 < S \leq 150$	$S > 150$																												
$\Phi \leq 0.10$	NC	NC	NC	NC	NC																												
$0.10 < \Phi \leq 0.20$	1	2	2	3	3																												
$0.20 < \Phi \leq 0.30$	1	1	2	2	3																												
$\Phi > 0.30$	0	0	0	0	0																												
5.1.11	<p>Linear type</p> 	<p>Suppose S= The area of A, the criteria in A&B is as below,</p> <table border="1" data-bbox="592 589 1353 801"> <thead> <tr> <th>S (cm²) \ a&b (mm)</th> <th>$S \leq 4$</th> <th>$4 < S \leq 12$</th> <th>$12 < S \leq 50$</th> <th>$50 < S \leq 150$</th> <th>$S > 150$</th> </tr> </thead> <tbody> <tr> <td>$a \leq 0.03$</td> <td>NC</td> <td>NC</td> <td>NC</td> <td>NC</td> <td>NC</td> </tr> <tr> <td>$0.03 < a \leq 0.05, b \leq 3$</td> <td>2</td> <td>3</td> <td>4</td> <td>5</td> <td>6</td> </tr> <tr> <td>$a > 0.05$</td> <td colspan="5">According to the criteria of <5.1.10></td> </tr> </tbody> </table> <p>Remark: Linear scratch, dirt line should be regarded as linear defect. Maximum defect number in 1cm² is 1.</p>	S (cm ²) \ a & b (mm)	$S \leq 4$	$4 < S \leq 12$	$12 < S \leq 50$	$50 < S \leq 150$	$S > 150$	$a \leq 0.03$	NC	NC	NC	NC	NC	$0.03 < a \leq 0.05, b \leq 3$	2	3	4	5	6	$a > 0.05$	According to the criteria of <5.1.10>					Minor						
S (cm ²) \ a & b (mm)	$S \leq 4$	$4 < S \leq 12$	$12 < S \leq 50$	$50 < S \leq 150$	$S > 150$																												
$a \leq 0.03$	NC	NC	NC	NC	NC																												
$0.03 < a \leq 0.05, b \leq 3$	2	3	4	5	6																												
$a > 0.05$	According to the criteria of <5.1.10>																																
5.1.12	<p>Polar bubble / Dent</p>  <p>$\Phi = (a+b) / 2$</p>	<p>Suppose S= The area of A, the criteria in A&B is as below,</p> <table border="1" data-bbox="592 931 1353 1167"> <thead> <tr> <th>S (cm²) \ Φ (mm)</th> <th>$S \leq 4$</th> <th>$4 < S \leq 12$</th> <th>$12 < S \leq 50$</th> <th>$50 < S \leq 150$</th> <th>$S > 150$</th> </tr> </thead> <tbody> <tr> <td>$\Phi \leq 0.15$</td> <td>NC</td> <td>NC</td> <td>NC</td> <td>NC</td> <td>NC</td> </tr> <tr> <td>$0.15 < \Phi \leq 0.25$</td> <td>1</td> <td>2</td> <td>2</td> <td>3</td> <td>3</td> </tr> <tr> <td>$0.25 < \Phi \leq 0.35$</td> <td>1</td> <td>1</td> <td>2</td> <td>2</td> <td>3</td> </tr> <tr> <td>$\Phi > 0.35$</td> <td>0</td> <td>0</td> <td>0</td> <td>0</td> <td>0</td> </tr> </tbody> </table> <p>Remark: Maximum defect number in 1cm² is 1.</p>	S (cm ²) \ Φ (mm)	$S \leq 4$	$4 < S \leq 12$	$12 < S \leq 50$	$50 < S \leq 150$	$S > 150$	$\Phi \leq 0.15$	NC	NC	NC	NC	NC	$0.15 < \Phi \leq 0.25$	1	2	2	3	3	$0.25 < \Phi \leq 0.35$	1	1	2	2	3	$\Phi > 0.35$	0	0	0	0	0	Minor
S (cm ²) \ Φ (mm)	$S \leq 4$	$4 < S \leq 12$	$12 < S \leq 50$	$50 < S \leq 150$	$S > 150$																												
$\Phi \leq 0.15$	NC	NC	NC	NC	NC																												
$0.15 < \Phi \leq 0.25$	1	2	2	3	3																												
$0.25 < \Phi \leq 0.35$	1	1	2	2	3																												
$\Phi > 0.35$	0	0	0	0	0																												
5.1.13	Polarizer Stab	According to the criteria of <5.1.10>	Minor																														
5.1.14	Polarizer Scratch	According to the criteria of <5.1.11>	Minor																														
5.1.15	<p>FPC Pinhole</p> 	<table border="1" data-bbox="592 1296 1114 1397"> <thead> <tr> <th>a</th> <th>b</th> <th>Allowed Qty.</th> </tr> </thead> <tbody> <tr> <td>$\leq W/3$</td> <td>$\leq W$</td> <td>NC</td> </tr> <tr> <td>$> W/3$</td> <td>$> W$</td> <td>Not allowed</td> </tr> </tbody> </table> <p>¹ Suppose Length:Width = 4:3, The conversion between S & diagonal length is as below table,</p> <table border="1" data-bbox="592 1447 1031 1644"> <thead> <tr> <th>S (cm²)</th> <th>Diagonal Length (Inch)</th> </tr> </thead> <tbody> <tr> <td>4</td> <td>1.13</td> </tr> <tr> <td>12</td> <td>1.95</td> </tr> <tr> <td>50</td> <td>3.99</td> </tr> <tr> <td>150</td> <td>6.91</td> </tr> </tbody> </table>	a	b	Allowed Qty.	$\leq W/3$	$\leq W$	NC	$> W/3$	$> W$	Not allowed	S (cm ²)	Diagonal Length (Inch)	4	1.13	12	1.95	50	3.99	150	6.91	Minor											
a	b	Allowed Qty.																															
$\leq W/3$	$\leq W$	NC																															
$> W/3$	$> W$	Not allowed																															
S (cm ²)	Diagonal Length (Inch)																																
4	1.13																																
12	1.95																																
50	3.99																																
150	6.91																																
5.1.16	<p>FPC Copper Residue</p> 	<table border="1" data-bbox="592 1648 1114 1749"> <thead> <tr> <th>a</th> <th>b</th> <th>Allowed Qty.</th> </tr> </thead> <tbody> <tr> <td>$\leq W/3$</td> <td>$\leq W$</td> <td>NC</td> </tr> <tr> <td>$> W/3$</td> <td>$> W$</td> <td>Not allowed</td> </tr> </tbody> </table>	a	b	Allowed Qty.	$\leq W/3$	$\leq W$	NC	$> W/3$	$> W$	Not allowed	Minor																					
a	b	Allowed Qty.																															
$\leq W/3$	$\leq W$	NC																															
$> W/3$	$> W$	Not allowed																															
5.1.17	FPC Impress / Crease	<table border="1" data-bbox="592 1783 1074 1939"> <thead> <tr> <th>Shape</th> <th>Allowed Qty.</th> </tr> </thead> <tbody> <tr> <td>Moulage / Impress</td> <td>NC</td> </tr> <tr> <td>Crease with a sharp angle</td> <td>Not allowed</td> </tr> </tbody> </table>	Shape	Allowed Qty.	Moulage / Impress	NC	Crease with a sharp angle	Not allowed	Minor																								
Shape	Allowed Qty.																																
Moulage / Impress	NC																																
Crease with a sharp angle	Not allowed																																
5.1.18	Soldering defect	According to the criteria of IPC-A-610C	Minor																														

5.2 Defect when display (Energized)

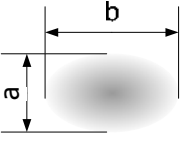
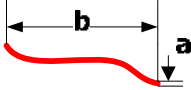
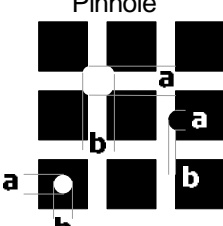
NO.	Defect Name & Illustration	Criteria	Class																														
5.2.1	Circular type when display (Not change along with voltage)	According to the criteria of <5.1.10>	Minor																														
5.2.2	<p>Circular type when display (Change along with voltage)</p>  <p>$\Phi = (a+b) / 2$</p>	<p>Suppose S= The area of A, the criteria in A&B is as below,</p> <table border="1"> <thead> <tr> <th>S (cm²) \ Φ (mm)</th> <th>S≤4</th> <th>4<S≤12</th> <th>12<S≤50</th> <th>50<S≤150</th> <th>S>150</th> </tr> </thead> <tbody> <tr> <td>Φ≤0.30</td> <td>NC</td> <td>NC</td> <td>NC</td> <td>NC</td> <td>NC</td> </tr> <tr> <td>0.30<Φ≤0.50</td> <td>1</td> <td>2</td> <td>2</td> <td>3</td> <td>3</td> </tr> <tr> <td>0.50<Φ≤0.80</td> <td>1</td> <td>1</td> <td>2</td> <td>2</td> <td>3</td> </tr> <tr> <td>Φ>0.80</td> <td>0</td> <td>0</td> <td>0</td> <td>0</td> <td>0</td> </tr> </tbody> </table> <p>Remark: Maximum defect number in 1cm² is 1.</p>	S (cm ²) \ Φ (mm)	S≤4	4<S≤12	12<S≤50	50<S≤150	S>150	Φ≤0.30	NC	NC	NC	NC	NC	0.30<Φ≤0.50	1	2	2	3	3	0.50<Φ≤0.80	1	1	2	2	3	Φ>0.80	0	0	0	0	0	Minor
S (cm ²) \ Φ (mm)	S≤4	4<S≤12	12<S≤50	50<S≤150	S>150																												
Φ≤0.30	NC	NC	NC	NC	NC																												
0.30<Φ≤0.50	1	2	2	3	3																												
0.50<Φ≤0.80	1	1	2	2	3																												
Φ>0.80	0	0	0	0	0																												
5.2.3	Linear type when display (Not change along with voltage)	According to the criteria of <5.1.1>	Minor																														
5.2.4	<p>Linear type when display (Change along with voltage)</p> 	<p>Suppose S= The area of A, the criteria in A&B is as below,</p> <table border="1"> <thead> <tr> <th>S (cm²) \ a&b (mm)</th> <th>S≤4</th> <th>4<S≤12</th> <th>12<S≤50</th> <th>50<S≤150</th> <th>S>150</th> </tr> </thead> <tbody> <tr> <td>a≤0.05</td> <td>NC</td> <td>NC</td> <td>NC</td> <td>NC</td> <td>NC</td> </tr> <tr> <td>0.05<a≤0.10, b≤5</td> <td>2</td> <td>3</td> <td>4</td> <td>5</td> <td>6</td> </tr> <tr> <td>a>0.10</td> <td colspan="5">According to the criteria of <5.2.2></td> </tr> </tbody> </table> <p>Remark: Maximum defect number in 1cm² is 1.</p>	S (cm ²) \ a&b (mm)	S≤4	4<S≤12	12<S≤50	50<S≤150	S>150	a≤0.05	NC	NC	NC	NC	NC	0.05<a≤0.10, b≤5	2	3	4	5	6	a>0.10	According to the criteria of <5.2.2>					Minor						
S (cm ²) \ a&b (mm)	S≤4	4<S≤12	12<S≤50	50<S≤150	S>150																												
a≤0.05	NC	NC	NC	NC	NC																												
0.05<a≤0.10, b≤5	2	3	4	5	6																												
a>0.10	According to the criteria of <5.2.2>																																
5.2.5	<p>Pinhole</p>  <p>$\Phi = (a+b) / 2$</p>	<p>Suppose S= The area of A, the criteria in A&B is as below,</p> <table border="1"> <thead> <tr> <th>S (cm²) \ Φ (mm)</th> <th>S≤4</th> <th>4<S≤12</th> <th>12<S≤50</th> <th>50<S≤150</th> <th>S>150</th> </tr> </thead> <tbody> <tr> <td>Φ≤0.10</td> <td>NC</td> <td>NC</td> <td>NC</td> <td>NC</td> <td>NC</td> </tr> <tr> <td>0.10<Φ≤0.15</td> <td>1</td> <td>2</td> <td>2</td> <td>3</td> <td>3</td> </tr> <tr> <td>0.15<Φ≤0.25</td> <td>1</td> <td>1</td> <td>2</td> <td>2</td> <td>3</td> </tr> <tr> <td>Φ>0.25</td> <td>0</td> <td>0</td> <td>0</td> <td>0</td> <td>0</td> </tr> </tbody> </table> <p>Remark: Maximum defect number in 1cm² is 1.</p>	S (cm ²) \ Φ (mm)	S≤4	4<S≤12	12<S≤50	50<S≤150	S>150	Φ≤0.10	NC	NC	NC	NC	NC	0.10<Φ≤0.15	1	2	2	3	3	0.15<Φ≤0.25	1	1	2	2	3	Φ>0.25	0	0	0	0	0	Major
S (cm ²) \ Φ (mm)	S≤4	4<S≤12	12<S≤50	50<S≤150	S>150																												
Φ≤0.10	NC	NC	NC	NC	NC																												
0.10<Φ≤0.15	1	2	2	3	3																												
0.15<Φ≤0.25	1	1	2	2	3																												
Φ>0.25	0	0	0	0	0																												
5.2.6	Segment Distortion	More than 1/5 size in spec is not allowed.	Major																														
5.2.7	Missing Segment (Row or column)	Not allowed	Major																														
5.2.8	Abnormal Display	Not allowed	Major																														
5.2.9	Display inhomogeneity / CR inhomogeneity	According to the approved sample by both sides	Minor																														
5.2.10	Too much current	Not allowed	Major																														
5.2.11	No display	Not allowed	Major																														
5.2.12	No backlight / flicking	Not allowed	Major																														

6 Caution for using

Recommended storage condition: 50~60%RH, 25+/-5°C;

Avoid direct sunlight. Avoid operating or storage under the temperature which exceeds the standard for a long time;

Avoid driving LCD with DC (Direct Current);

LCD was made of glass, please avoid any impact or pressure on surface;

If the skin contact with liquid crystal incautiously, wash with water for more than 15 minutes. If you feel uncomfortable, please see the doctor immediately;

It is prohibited to clean polarizer by ethanol or acetone. Clean polarizer by pure water is recommended;

The products should be used within 6 month. Otherwise, the ITO pad and FPC pad maybe be oxidized and cause poor contact, etc.;

ESD: TFT module or COG module is sensitive to ESD, effective action should be taken before you touch the products;

Avoid contacting the ITO pad by hand and pressing the surface of the LCD. Please take the both sides when you fetch the LCD.

7 Reliability-TEST

7.1. Standard Specifications for Reliability

7.1-1 Test method

There should be no existing conspicuous failure of functions and appearance in LCD after the following tests.

NO	Item	Description
1	Low Temperature Operating	The sample should be allowed to stand at $(-10\pm 2)^{\circ}\text{C}$ for 96 Hours under driving condition.
2	High Temperature Operating	The sample should be allowed to stand at $(+60\pm 2)^{\circ}\text{C}$ for 96 Hours under driving condition.
3	Low Temperature Storage	The sample should be allowed to stand at $(-20\pm 3)^{\circ}\text{C}$ for 96 Hours under no-load condition, and then returning it to normal temperature condition, and allowing it stand for 24 hours
4	High Temperature Storage	The sample should be allowed to stand at $(+70\pm 2)^{\circ}\text{C}$ for 96Hours under no-load condition, and then returning it to normal temperature condition, and allowing it stand for 24 hours
5	Moisture resistance	The sample should be allowed to stand at $(40\pm 2)^{\circ}\text{C}$, $(95\pm 2)\% \text{RH}$ for 96Hours under no-load condition excluding the polarizer, then taking it out and drying it at normal temperature, and allowing it stand for 24 hours

Note:

T_{STL} : Lowest Storage Operation Temperature.

T_{STH} : Lowest Storage Temperature.

7.1-2 Testing Conditions and Inspection Criteria:

For the final test, the testing sample must be stored at room temperature for 24 hours, after the tests listed above; Standard specifications for Reliability have been executed in order to ensure stability.

NO	Item	Inspection Criteria
1	Current Consumption	The current consumption should be under double of initial test.
2	Contrast	The contrast must be larger than half of initial test.
3	Appearance	Appearance defects should not happen.

7.2 Life Time:

Functions, performance, appearance, etc. shall be free from remarkable deterioration within 50,000 hours under ordinary operating and storage conditions room temperature ($25\pm 10^{\circ}\text{C}$), normal humidity ($45\pm 20\% \text{RH}$), and in area not exposed to direct sunlight.