

RF & MICROWAVE TRANSISTORS AVIONICS APPLICATIONS

- REFRACTORY/GOLD METALLIZATION
- EMITTER SITE BALLASTING
- LOW RF THERMAL RESISTANCE
- INPUT/OUTPUT MATCHING
- OVERLAY GEOMETRY
- METAL/CERAMIC HERMETIC PACKAGE
- P_{OUT} = 325 W MIN. WITH 7.7 dB GAIN
- 1030/1090 MHZ OPERATION

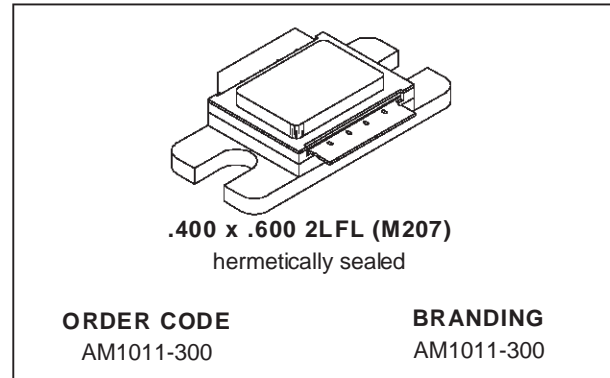

DESCRIPTION

The AM1011-300 is a rugged, Class C common base device specifically designed for new Mode-S interrogator and transponder applications.

Minimal amplitude droop over the heavy Mode-S pulse burst is guaranteed by a thermal design incorporating an overlay site-ballasted die geometry.

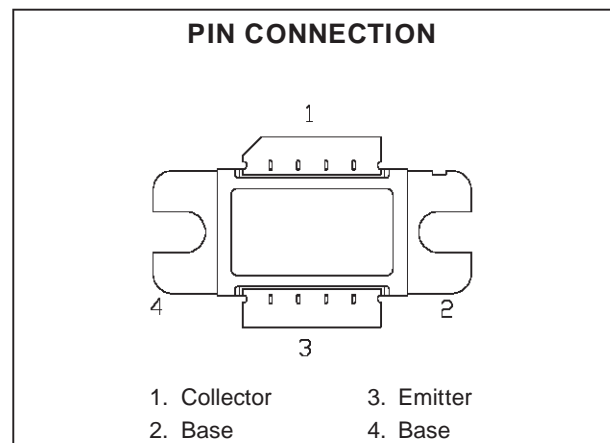

ABSOLUTE MAXIMUM RATINGS (T_{case} = 25°C)

Symbol	Parameter	Value	Unit
P _{DISS}	Power Dissipation (T _C ≤ 100°C)*	1070	W
I _C	Device Current*	36	A
V _{CC}	Collector-Supply Voltage*	43	V
T _J	Junction Temperature (Pulsed RF operation)	+250	°C
T _{STG}	Storage Temperature	- 65 to +200	°C

THERMAL DATA

R _{TH(j-c)}	Junction-Case Thermal Resistance*	0.14	°C/W
----------------------	-----------------------------------	------	------

*Applies only to rated RF amplifier operation.

ELECTRICAL SPECIFICATIONS ($T_{case} = 25^{\circ}C$)

STATIC

Symbol	Test Conditions		Value			Unit
			Min.	Typ.	Max.	
BV_{CBO}	$I_C = 75\text{ mA}$	$I_E = 0\text{ mA}$	65	—	—	V
BV_{CES}	$I_C = 75\text{ mA}$	$V_{BE} = 0\text{ V}$	65	—	—	V
BV_{EBO}	$I_C = 25\text{ mA}$	$I_C = 0\text{ mA}$	3.0	—	—	V
I_{CES}	$V_{CE} = 40\text{ V}$	$V_{BE} = 0\text{ V}$	—	—	30	mA
h_{FE}	$V_{CE} = 5\text{ V}$	$I_C = 10\text{ A}$	10	—	—	—

DYNAMIC

Symbol	Test Conditions			Value			Unit
				Min.	Typ.	Max.	
P_{OUT}	$f = 1090\text{ MHz}$	$P_{IN} = 55\text{ W}$	$V_{CC} = 40\text{ V}$	325	350	—	W
hc	$f = 1090\text{ MHz}$	$P_{OUT} = 325\text{ W}$	$V_{CC} = 40\text{ V}$	40	45	—	%
G_P	$f = 1090\text{ MHz}$	$P_{OUT} = 325\text{ W}$	$V_{CC} = 40\text{ V}$	7.7	8.0	—	dB

Pulse Conditions: Pulse width = 200 μ s, Duty Cycle = 5%, are equivalent to the following pulse burst conditions:
 Mode-S Interrogator (freq = 1030MHz)
 32 pulses, 32 μ s on, 18 μ s off, burst period = 17.6ms
 long term duty = 5.82%

TYPICAL PERFORMANCE

POWER OUTPUT vs POWER INPUT @ 1030 MHz

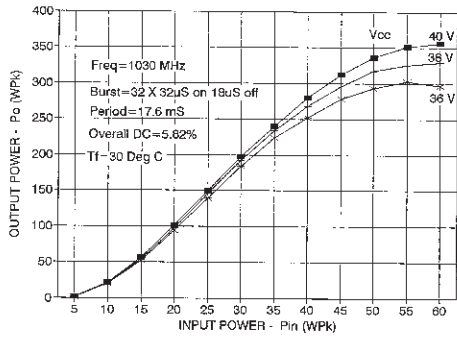

POWER OUTPUT vs POWER INPUT @ 1090 MHz

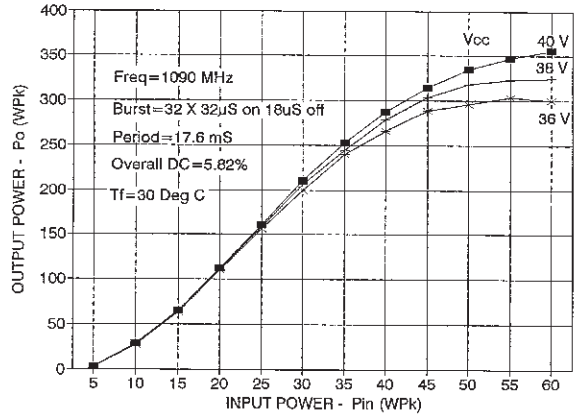

MAXIMUM THERMAL RESISTANCE vs PULSE WIDTH

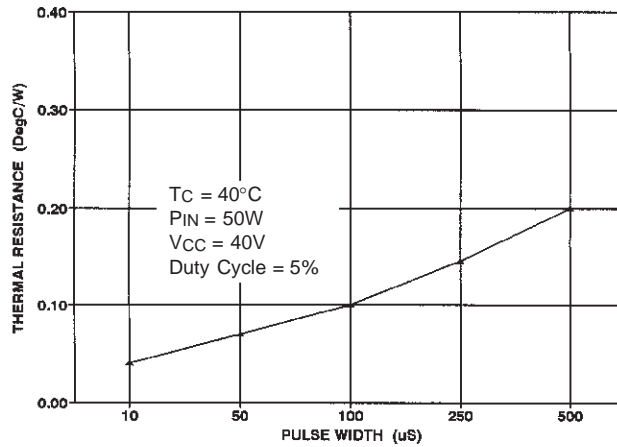

IMPEDANCE DATA

TYPICAL INPUT IMPEDANCE

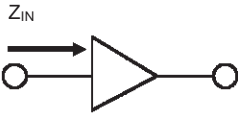

TYPICAL COLLECTOR LOAD

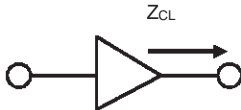

FREQ.	Z _{IN} (Ω)	Z _{CL} (Ω)
1030 MHz	0.7 + j 4.1	0.78 - j 2.4
1090 MHz	0.65 + j 4.2	0.4 - j 2.4

P_{IN} = 55W

TEST CIRCUIT

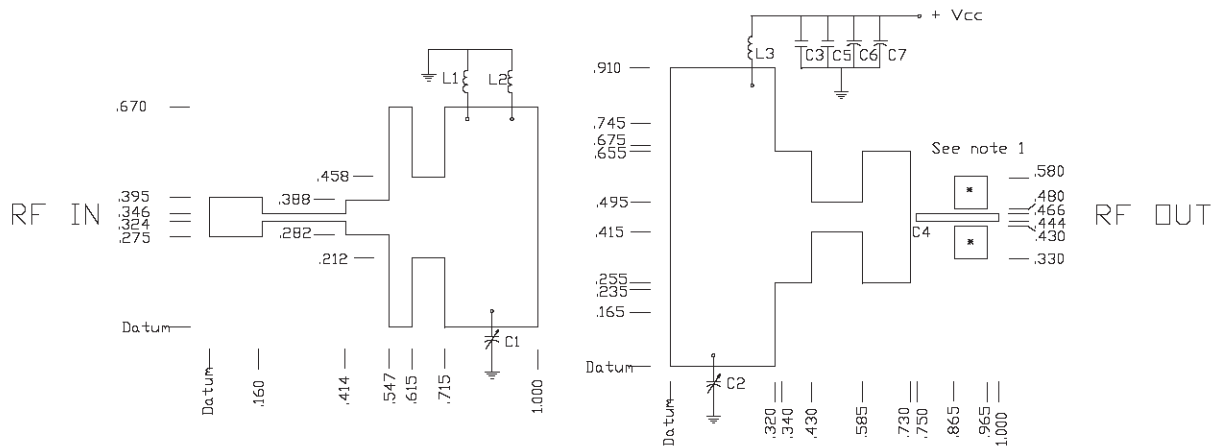

- C1 : 0.8-8.0 pf Johanson Gigatrim
- C2 : 0.6-4.5 pf Johanson Gigatrim
- C3,C4 : 100 pf Chips
- C5 : 47 pf Chip
- C6 : 10 uF Tantalum,50 V
- C7 : 100 uF Electrolytic,63 V
- L1,L2 : Straps 0.300" long,0.100" wide and 0.005" thick
- L3 : 3 Turns #24 wire,0.085" ID
- Substrate : Er=10.2 H=0.025"

- Notes:
1. Freq=1030/1090 MHz
* denotes areas to be connected for 1030 MHz operation only.
 2. Power supply should have at least 5 Joules (6600 uF) of energy storage.
 3. Air cooling required.
 4. All dimensions are in inches.

PACKAGE MECHANICAL DATA

Ref.: Dwg. No. 12-0207
UDCS No. 1011408 rev B

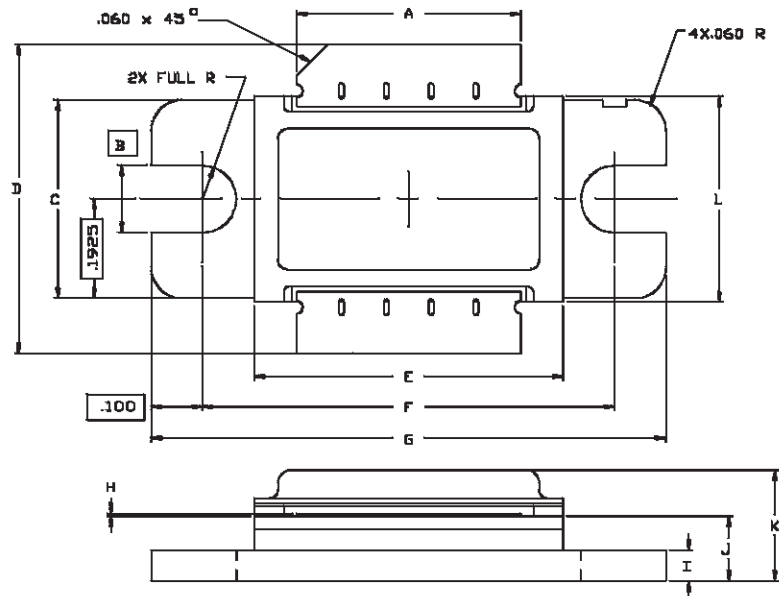

SGS-THOMSON MICROELECTRONICS			CONT'D		
	MINIMUM Inches/mm	MAXIMUM Inches/mm		MINIMUM Inches/mm	MAXIMUM Inches/mm
A	.435/11,05	.445/11,30	K		.230/5,84
B	.130/3,30		L	.395/10,03	.407/10,34
C	.380/9,65	.390/9,91			
D	.570/14,48	.630/16,00			
E	.590/14,99	.610/15,49			
F	.790/20,07	.810/20,57			
G	.995/25,27	1.010/25,65			
H	.003/0,08	.006/0,13			
I	.055/1,40	.065/1,65			
J	.115/2,92	.130/3,30			

Information furnished is believed to be accurate and reliable. However, SGS-THOMSON Microelectronics assumes no responsibility for the consequences of use of such information nor for any infringement of patents or other rights of third parties which may result from its use. No license is granted by implication or otherwise under any patent or patent rights of SGS-THOMSON Microelectronics. Specifications mentioned in this publication are subject to change without notice. This publication supersedes and replaces all information previously supplied. SGS-THOMSON Microelectronics products are not authorized for use as critical components in life support devices or systems without express written approval of SGS-THOMSON Microelectronics.

©1997 SGS-THOMSON Microelectronics - All Rights Reserved

SGS-THOMSON Microelectronics GROUP OF COMPANIES
Australia - Brazil - Canada - China - France - Germany - Italy - Japan - Korea
Malaysia - Malta - Morocco - The Netherlands - Singapore - Spain - Sweden - Switzerland
Taiwan - Thailand - United Kingdom - U.S.A.