

Dual-Band WLAN Dual Diplexer 2.4–2.5 GHz and 5–6 GHz

AM119

Applications

- WLAN Systems Including 802.11a,b,g

Features

- LTCC Technology
- Dual Diplexer
- SMD Package, 5.0 x 3.25 x 1.2 mm
- Dual-Band Diplex Receive, Dual-Band Diplex Transmit

Description

The AM119 is a ceramic dual diplexer for dual-band WLAN systems using LTCC design and manufacturing technology. The part consists of two diplexers, one for dual-band receive and one for dual-band transmit. The AM119-614 is utilized with the diversity switch AS218-321 for switching between antennas. The design is compatible with the 802.11 WLAN specifications.

Outline Drawing

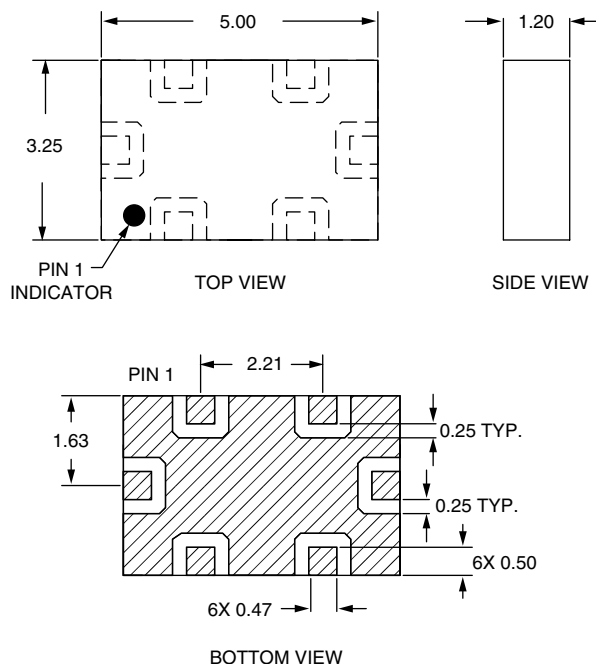

Dimensions in mm.
Tolerance ± 0.2 mm unless otherwise specified.

Electrical Specifications at 25°C

Mode	Parameter	Min.	Typ.	Max.	Unit
Low Pass	Passband	2.4	2.45	2.5	GHz
	Insertion Loss		0.50	0.8	dB
	Attenuation @ 4.8 GHz		35		dB
	Return Loss		15		dB
High Pass	Passband	5.15	5.50	5.85	GHz
	Insertion Loss		0.50	0.80	dB
	Attenuation @ 2.5 GHz		25		dB
	Return Loss		12		dB

Typical Performance Data

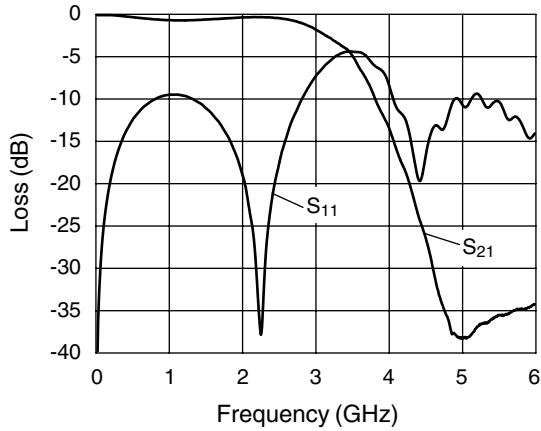

IN 1 to LP1, Wideband

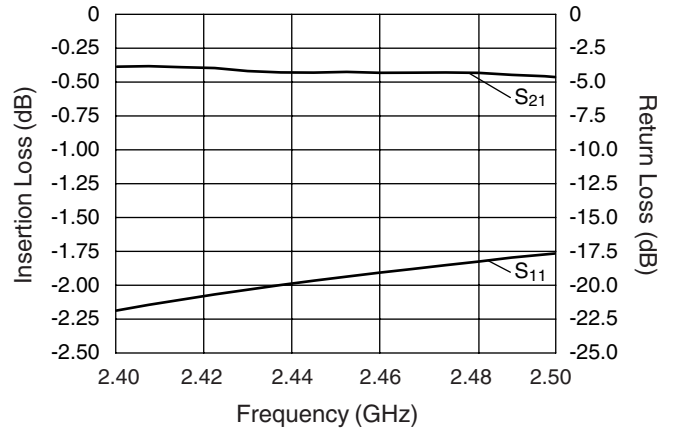

IN 1 to LP1, In Band

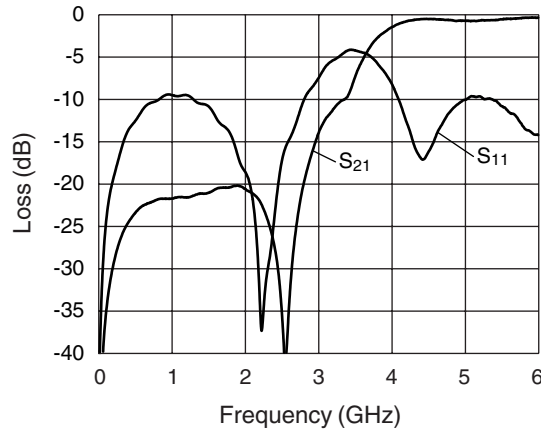

IN 1 to HP1, Wideband

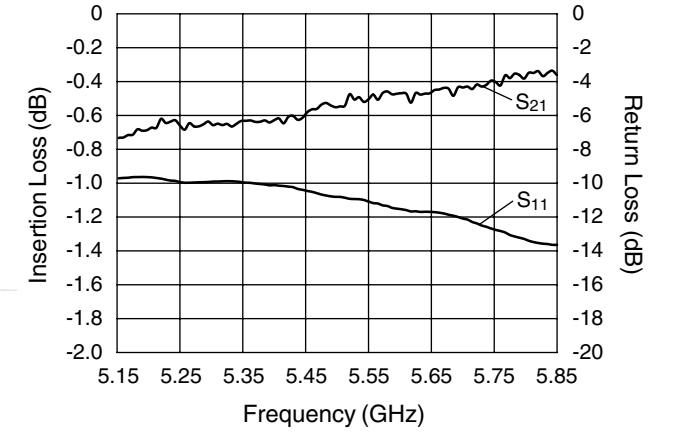

IN 1 to HP1, In Band

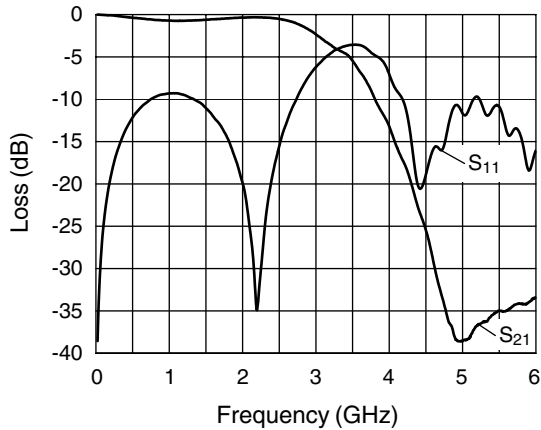

IN 2 to LP2, Wideband

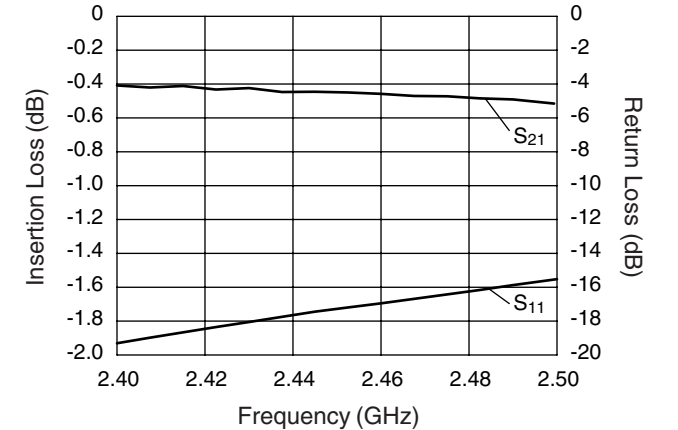

IN 2 to LP2, In Band

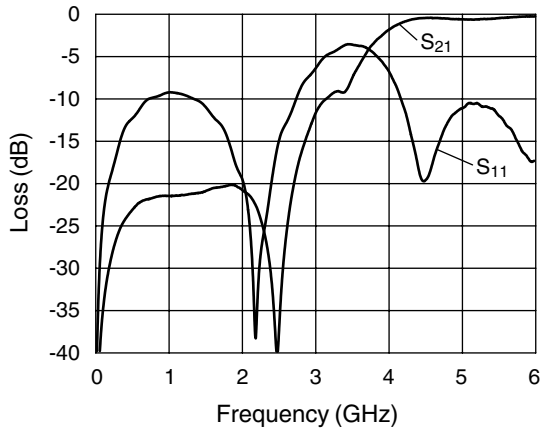

IN 2 to HP2, Wideband

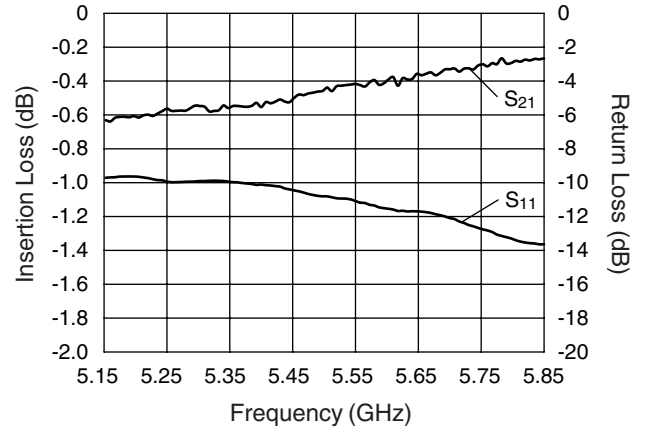

IN 2 to HP2, In Band

Block Diagram

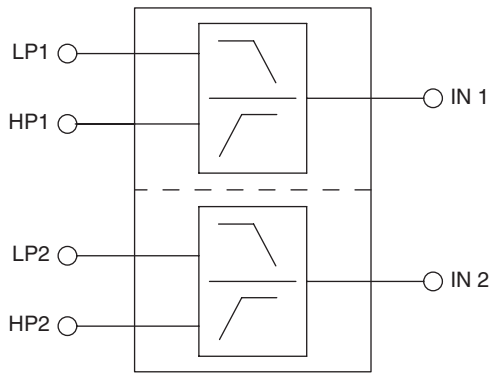

Pin Out (Top View)

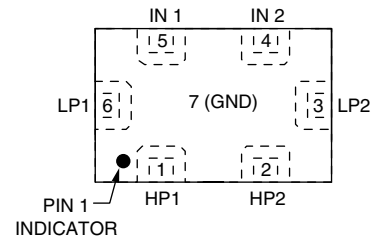

Suggested Land Pattern

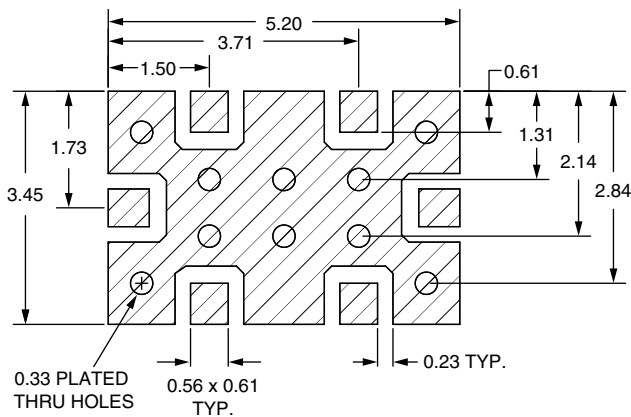

AM119-614 Evaluation PCB

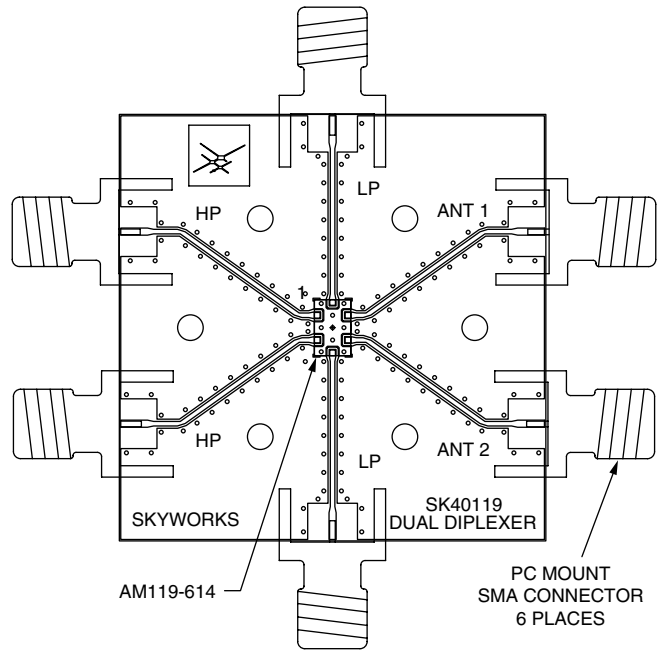

PCB# SK40119. Material: Rogers RO4003.
 The circuit board used in the final application should employ RF circuit design techniques. RF signal lines should have 50 Ω impedance. The package bottom ground plane should be connected directly to PCB ground plane. A sufficient number of via holes should be used to connect the top and bottom ground planes. The evaluation circuit board shown is available upon request.