

## N-Channel 100-V (D-S) MOSFET

### Key Features:

- Low  $r_{DS(on)}$  trench technology
- Low thermal impedance
- Fast switching speed

### Typical Applications:

- LED Inverter Circuits
- DC/DC Conversion Circuits
- Motor drives

PRODUCT SUMMARY		
$V_{DS}$ (V)	$r_{DS(on)}$ (m $\Omega$ )	$I_D$ (A)
100	9 @ $V_{GS} = 10V$	190 <sup>a</sup>
	10.5 @ $V_{GS} = 5.5V$	



RoHS  
COMPLIANT  
HALOGEN  
FREE

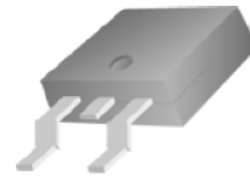

TO-263

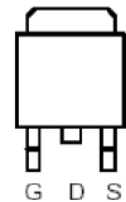

Top View

### ABSOLUTE MAXIMUM RATINGS ( $T_A = 25^\circ\text{C}$ UNLESS OTHERWISE NOTED)

Parameter	Symbol	Limit	Units
Drain-Source Voltage	$V_{DS}$	100	V
Gate-Source Voltage	$V_{GS}$	$\pm 20$	
Continuous Drain Current <sup>a</sup>	$I_D$	190	A
Pulsed Drain Current <sup>b</sup>	$I_{DM}$	750	
Continuous Source Current (Diode Conduction) <sup>a</sup>	$I_S$	190	A
Power Dissipation	$P_D$	300	W
Operating Junction and Storage Temperature Range	$T_J, T_{stg}$	-55 to 175	$^\circ\text{C}$

### THERMAL RESISTANCE RATINGS

Parameter	Symbol	Maximum	Units
Maximum Junction-to-Ambient <sup>c</sup>	$R_{\theta JA}$	62.5	$^\circ\text{C}/\text{W}$
Maximum Junction-to-Case	$R_{\theta JC}$	0.5	

### Notes

- Package Limited
- Pulse width limited by maximum junction temperature
- Surface Mounted on 1" x 1" FR4 Board.

## Electrical Characteristics

Parameter	Symbol	Test Conditions	Min	Typ	Max	Unit
<b>Static</b>						
Gate-Source Threshold Voltage	$V_{GS(th)}$	$V_{DS} = V_{GS}, I_D = 250 \mu A$	1			V
Gate-Body Leakage	$I_{GSS}$	$V_{DS} = 0 V, V_{GS} = \pm 20 V$			$\pm 100$	nA
Zero Gate Voltage Drain Current	$I_{DSS}$	$V_{DS} = 80 V, V_{GS} = 0 V$			1	uA
		$V_{DS} = 80 V, V_{GS} = 0 V, T_J = 55^\circ C$			10	
On-State Drain Current <sup>a</sup>	$I_{D(on)}$	$V_{DS} = 5 V, V_{GS} = 10 V$	240			A
Drain-Source On-Resistance <sup>a</sup>	$r_{DS(on)}$	$V_{GS} = 10 V, I_D = 20 A$			9	mΩ
		$V_{GS} = 5.5 V, I_D = 16 A$			10.5	
Forward Transconductance <sup>a</sup>	$g_{fs}$	$V_{DS} = 15 V, I_D = 20 A$		19		S
Diode Forward Voltage <sup>a</sup>	$V_{SD}$	$I_S = 95 A, V_{GS} = 0 V$		1		V
<b>Dynamic <sup>b</sup></b>						
Total Gate Charge	$Q_g$	$V_{DS} = 50 V, V_{GS} = 5.5 V,$ $I_D = 20 A$		140		nC
Gate-Source Charge	$Q_{gs}$			50		
Gate-Drain Charge	$Q_{gd}$			33		
Turn-On Delay Time	$t_{d(on)}$	$V_{DS} = 50 V, R_L = 2.5 \Omega,$ $I_D = 20 A,$ $V_{GEN} = 10 V, R_{GEN} = 6 \Omega$		38		ns
Rise Time	$t_r$			25		
Turn-Off Delay Time	$t_{d(off)}$			283		
Fall Time	$t_f$			60		
Input Capacitance	$C_{iss}$	$V_{DS} = 15 V, V_{GS} = 0 V, f = 1 \text{ Mhz}$		12354		pF
Output Capacitance	$C_{oss}$			516		
Reverse Transfer Capacitance	$C_{rss}$			422		

## Notes

- Pulse test:  $PW \leq 300 \mu s$  duty cycle  $\leq 2\%$ .
- Guaranteed by design, not subject to production testing.

**Analog Power (APL) reserves the right to make changes without further notice to any products herein. APL makes no warranty, representation or guarantee regarding the suitability of its products for any particular purpose, nor does APL assume any liability arising out of the application or use of any product or circuit, and specifically disclaims any and all liability, including without limitation special, consequential or incidental damages. "Typical" parameters which may be provided in APL data sheets and/or specifications can and do vary in different applications and actual performance may vary over time. All operating parameters, including "Typicals" must be validated for each customer application by customer's technical experts. APL does not convey any license under its patent rights nor the rights of others. APL products are not designed, intended, or authorized for use as components in systems intended for surgical implant into the body, or other applications intended to support or sustain life, or for any other application in which the failure of the APL product could create a situation where personal injury or death may occur. Should Buyer purchase or use APL products for any such unintended or unauthorized application, Buyer shall indemnify and hold APL and its officers, employees, subsidiaries, affiliates, and distributors harmless against all claims, costs, damages, and expenses, and reasonable attorney fees arising out of, directly or indirectly, any claim of personal injury or death associated with such unintended or unauthorized use, even if such claim alleges that APL was negligent regarding the design or manufacture of the part. APL is an Equal Opportunity/Affirmative Action Employer.**

Typical Electrical Characteristics

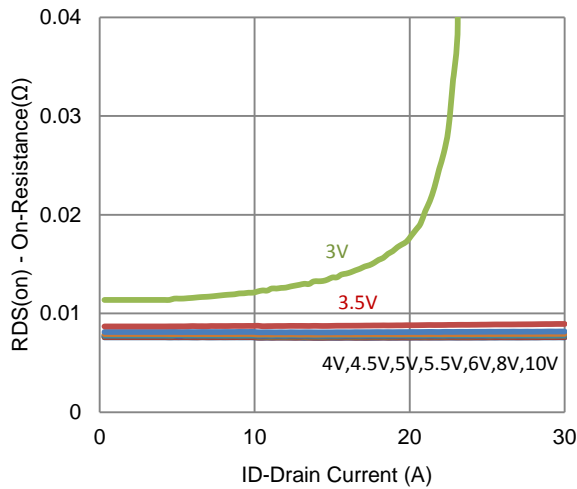

1. On-Resistance vs. Drain Current

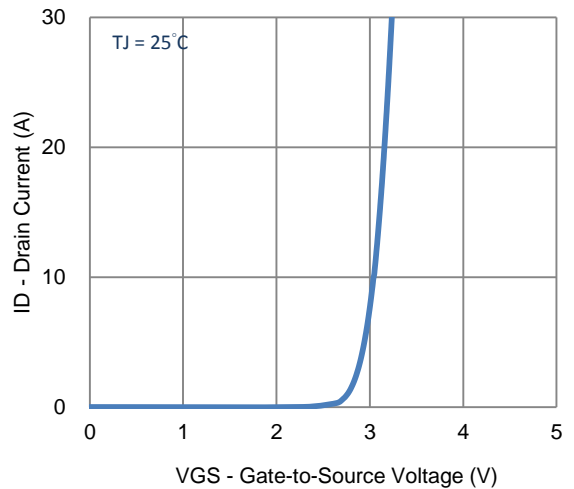

2. Transfer Characteristics

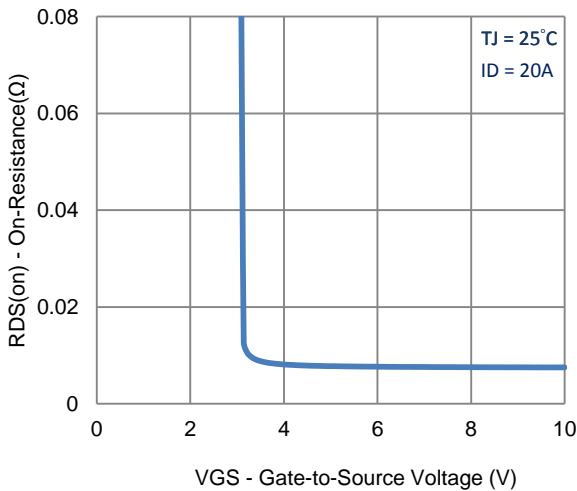

3. On-Resistance vs. Gate-to-Source Voltage

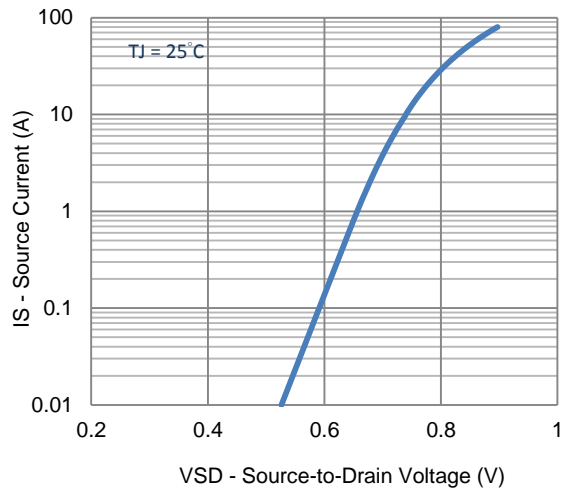

4. Drain-to-Source Forward Voltage

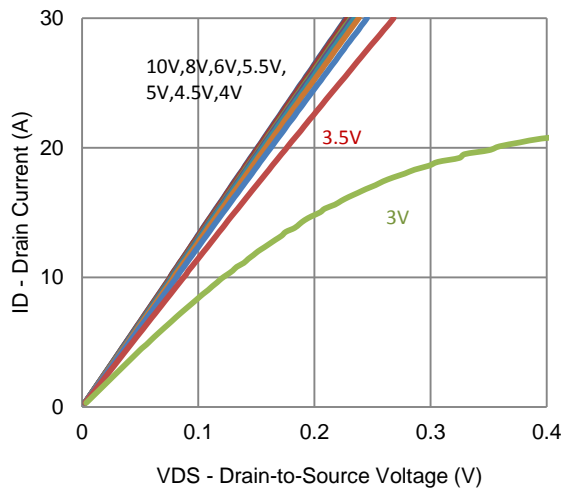

5. Output Characteristics

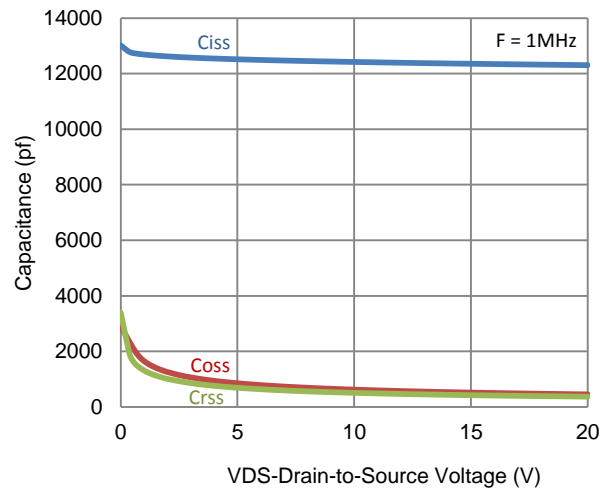

6. Capacitance

Typical Electrical Characteristics

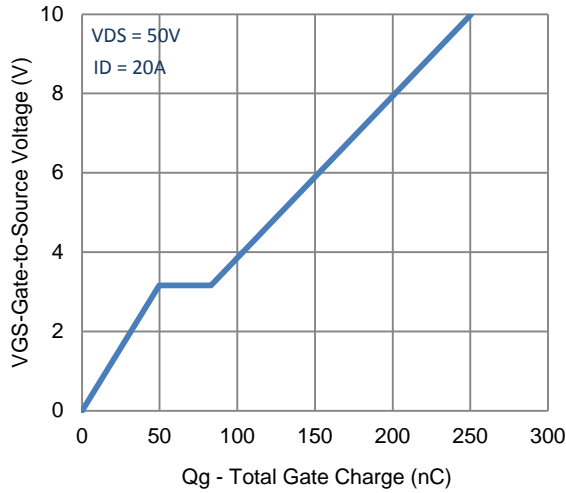

7. Gate Charge

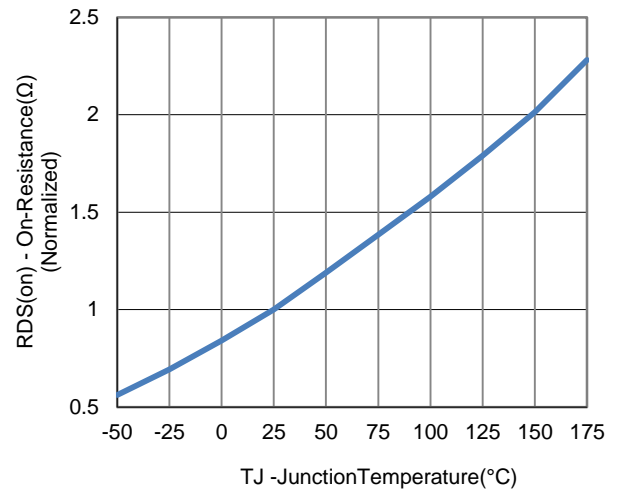

8. Normalized On-Resistance Vs Junction Temperature

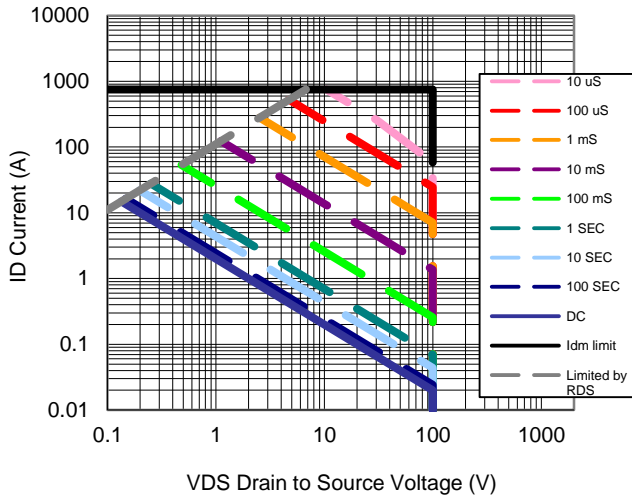

9. Safe Operating Area

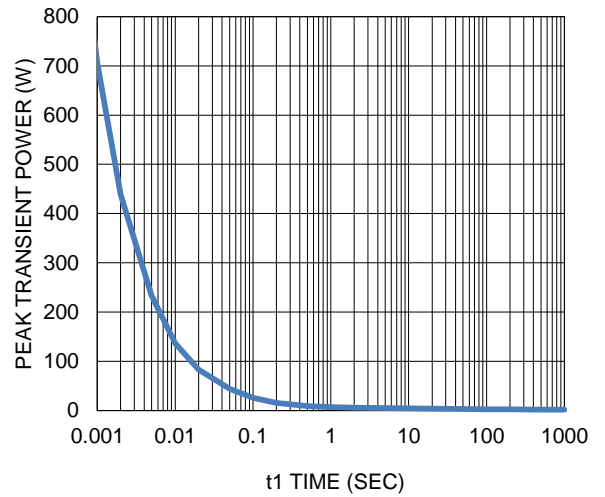

10. Single Pulse Maximum Power Dissipation

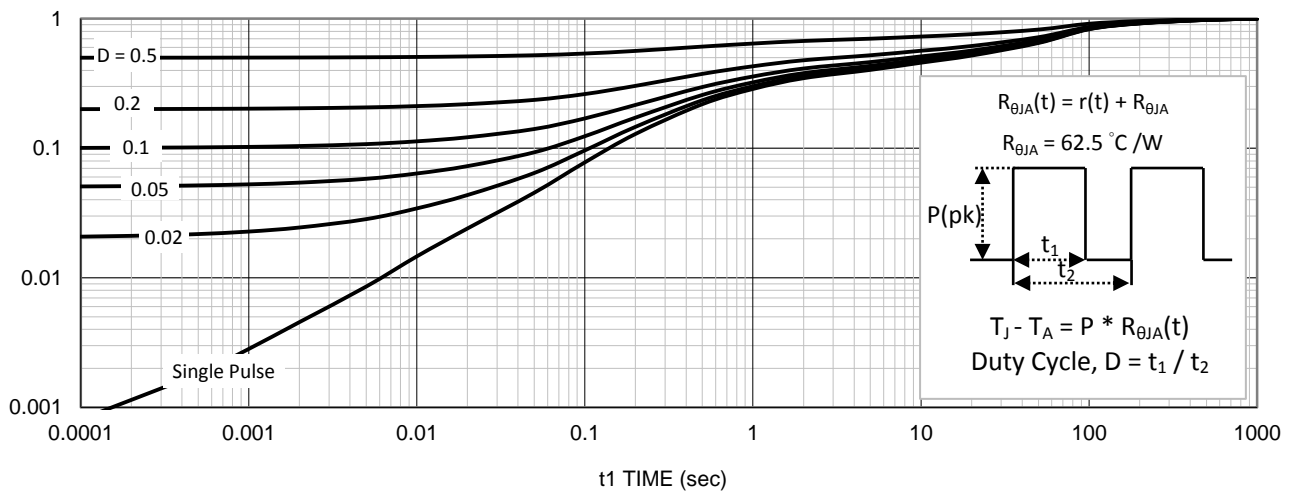

11. Normalized Thermal Transient Junction to Ambient

Package Information

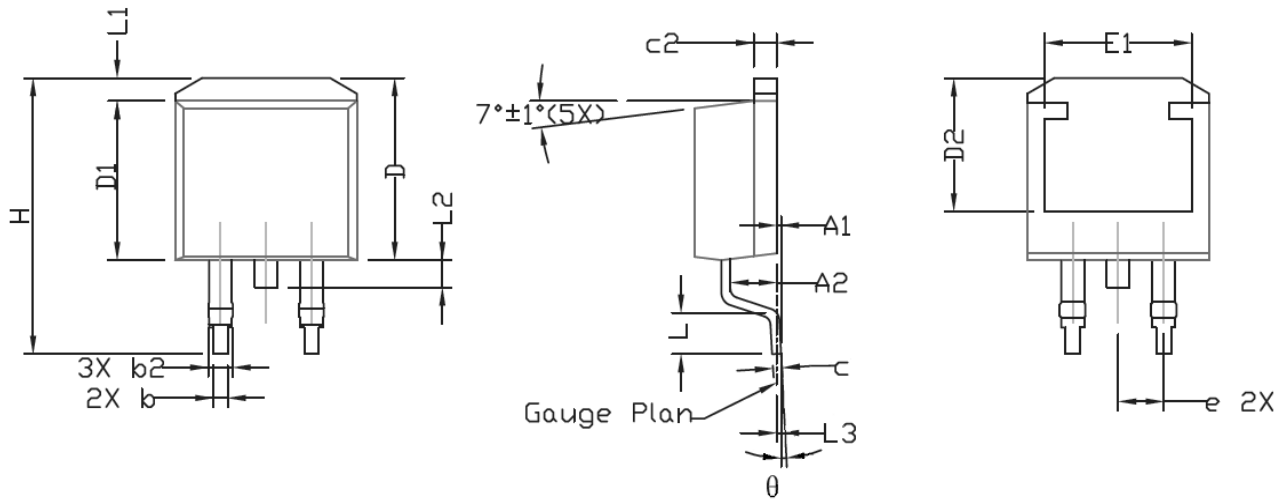

SYMBOL	DIMENSIONAL REQMTS			INCHES REQMTS		
	MTN	NOM	MAX	MTN	NOM	MAX
A	4.30	4.57	4.72	0.169	0.180	0.186
A1	0	---	0.25	0	---	0.010
A2	2.47	2.57	2.67	0.097	0.101	0.105
b	0.69	0.813	0.94	0.027	0.032	0.037
b2	1.17	1.27	1.45	0.046	0.050	0.057
c	0.48	0.50	0.60	0.019	0.020	0.024
c2	1.17	1.27	1.37	0.046	0.050	0.054
D	9.80	10.05	10.30	0.386	0.396	0.406
D1	8.64	8.78	9.65	0.340	0.346	0.380
D2	7.12	7.37	7.62	0.280	0.290	0.300
E	9.70	10.15	10.54	0.382	0.400	0.415
E1	8.00	8.20	8.40	0.315	0.323	0.331
e	2.54 BSC			0.100 BSC		
H	14.99	15.24	15.49	0.590	0.600	0.610
L	1.78	2.29	2.79	0.070	0.090	0.110
L1	1.02	1.27	1.52	0.040	0.050	0.060
L2	---	---	1.75	---	---	0.069
L3	---	0.254	---	---	0.010	---
$\theta$	0°	---	8°	0°	---	8°