

AOSONG

Digital Temperature and Humidity Sensor AM2321 Product Manual



Product Features:

- Ultra-small size
- Ultra Low Power
- Ultra-low voltage operation
- Excellent long-term stability
- Standard I2C and single-bus output

For more information, please visit: www.aosong.com

1. Product overview

Temperature and humidity combined sensor AM2321 digital temperature and humidity sensor is a digital signal output has been calibrated. Using special temperature and humidity acquisition technology, ensure that the product has a very high reliability and excellent long-term stability. Sensor consists of a capacitive moisture element and an integrated high-precision temperature measurement devices, and connected with a high-performance microprocessor . The product has excellent quality, super fast response, strong anti-interference ability, very high property price rate.



AM2321 communication using a single bus, two communication modes standard I²C. Standard single-bus interface, the system integration becomes easy and quick. Ultra-small size, low power consumption, signal transmission distance up to 20 meters, making all kinds of applications and even the most demanding applications the best choice. I²C communication using standard communication sequence, the user can directly linked to the I²C communication bus without additional wiring, simple to use. Two communication modes are used as humidity, temperature, and other digital information directly CRC checksum temperature-compensated output, users do not need to calculate the secondary digital output, and no need for temperature compensation of the humidity, temperature and humidity can be accurately information. Two communication modes are free to switch, the user can freely choose, easy to use, wide range of applications. 4 lead product, easy connection, special packages according to user needs and provide.

2. Applications

HVAC, dehumidifiers, testing and inspection equipment, consumer goods, automotive, automation, data loggers, gas stations, home appliances, humidity control, medical, and other relevant humidity measurement and control.

3. Product Highlights

Completely interchangeable, low-cost, long-term stability, relative humidity and temperature measurement, long distance signal transmission, the digital signal output, precise calibration, low power consumption, standard single-bus digital interface standard I²C bus digital interface, communication free choice.

4. Dimensions (Unit: mm)

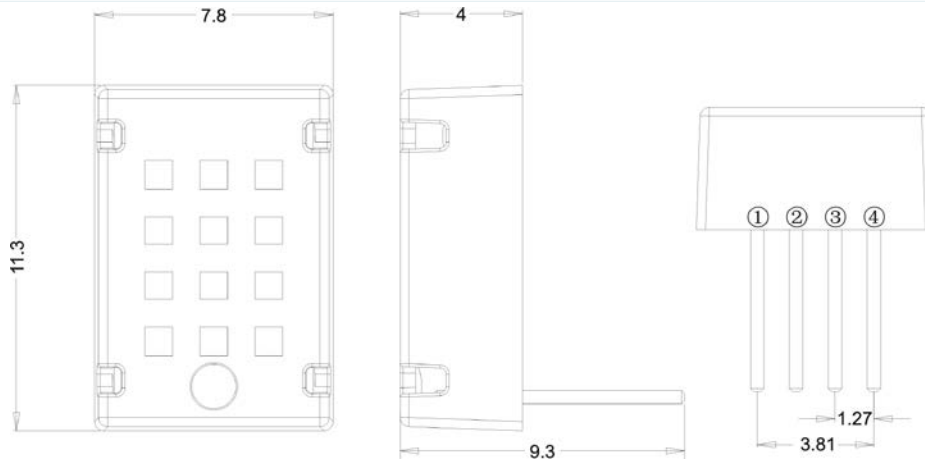

Figure 1 : AM2321 every inch form factor

External Interface: 1: VDD 2: SDA 3: GND 4: SCL

5. Sensor performance

5.1 Relative Humidity

Table 1: AM2321 relative humidity performance table

parameter	condition	min	typ	max	unit
resolution			0.1		%RH
Range		0		99.9	%RH
Accuracy	25°C		±3		%RH
Repeatability			±0.1		%RH
Interchangeability		Completely interchangeable			
Response time	1/e(63%)		<5		S
Sluggish			±0.3		%RH
Drift	Typical values		<0.5		%RH/yr

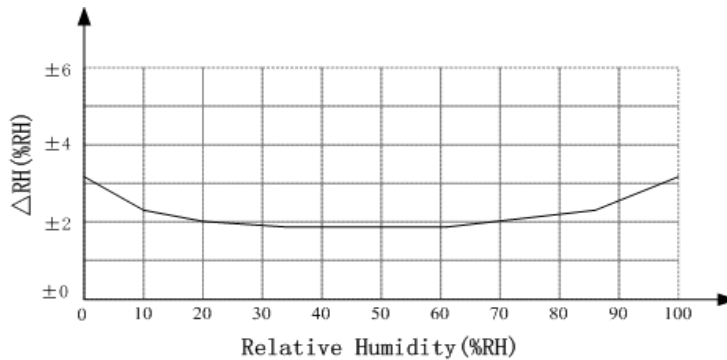

Figure 2: 25 °C relative humidity of maximum error AM2321

5.2 Temperature

Table 2: AM2321 relative temperature performance table

parameter	condition	min	typ	max	unit
resolution			0.1		°C
			16		bit
Accuracy			±0.5		°C
Range		-40		80	°C
Repeatability			±0.2		°C
Interchangeability					
Response time	1/e(63%)		<5		S
Drift			±0.1		°C/yr

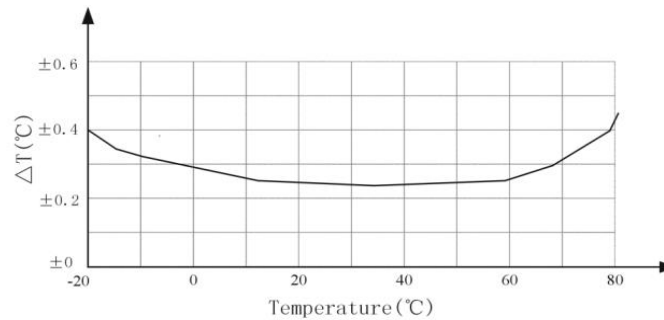

Figure 3: The maximum error of the temperature sensor

6. Electrical Characteristics

Electrical characteristics, such as high energy consumption, low level, input and output voltage, etc., depending on the power supply. Table 3 details the AM2321 electrical characteristics, if not marked, it means that the power supply voltage of 5V. If you want to get the best results with the sensor, please designed in strict accordance with please and conditions in Table 3 and Figure 27 and Figure 14 Design.

Table 3: AM2321 DC Characteristics

parameter	condition	min	typ	max	unit
Supply Voltage		2.6	5	5.5	v
Power Consumption ⁴	Dormancy	8	10		μA
	Measure		500		μA
	Average		200		μA
Low-level output voltage	I_{CC} ⁵	0		250	MV
High-level output voltage	R p<25 k	90%		100%	VDD
Low-level input voltage	Decline	0		30%	VDD
High-level input voltage	Rise	70%		100%	VDD
R p u ⁶	VDD = 5V VIN = VSS	30	45	60	k
Output Current	Open		8		MA
	Tri-State (Off)	10	20		μA
Sampling period		2.0			s

1. This accuracy is tested at the factory, and the sensor at 25 °C precision index 5V, under the conditions tested, it does not include hysteresis and non-linear, and only suitable for non-condensing environment.
2. At 25°C and 1m / s air flow conditions, to a first order effect 63% of the time to be needed.
3. values in the volatile organic compounds may be higher. See the manual application store information.
4. This value is VDD = 5.0V at a temperature of 25°C, 2S / Times, the average conditions.
5. Low-level output current.
7. show the resistor.

7. Interface Definition

7.1 AM2321 pin assignment

Table 4: AM2321 pin assignment

Pin	Name	Description
1	VDD	Power supply(2.6 -5.5V)
2	SDA	Serial data, bidirectional port
v3	GND	Ground
4	SCL	Serial clock input port (single bus ground)

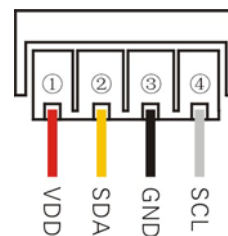

Figure 4: AM2321 wiring diagram

7.2 Power supply pin (VDD GND)

AM2321 supply voltage range of 2.6V - 5.5V.

7.3 Serial clock input (SCL)

The SCL pin is used to communicate the choice and I²C sensor communication clock line. When the power is held low while SCL remains low even 500ms, which means that the user selects a single bus mode of communication, otherwise I²C communications; After selecting the formula mode during power, sensor communication mode remains unchanged; If you want to change communication, re-power on, press the select operation requires communication.

When choosing the I²C communication between microprocessor and AM2321,SCL for the synchronous communication.

7.4 Serial data(SDA)

SDA pin is three-state structure for reading, writing sensor data. Detailed Description of specific communication sequence, see communication method..

8. I²C and a single bus

AM2321 serial interface, and power consumption reading sensor signal aspects are optimized processing. Sensor uses a single bus, I²C outputs two communication modes, communication can be switched freely, easy to use. SCL bus signal line to level when power to determine their bus communication: SCL is held low on power as a single bus communication mode; SCL remain high when compared to the power of communication modes I²C. Single bus is fully compatible with the company's other products, single-bus communication; I²C communication in accordance with

standard protocols addressing, can be directly linked to the I²C bus (the bus is only allowed to hang a product), without additional wiring, operation simple. Read AM2321 sensors, strictly in accordance with the agreement of the two communication methods and timing proceed. Specific details see single communication protocol and I²C bus communication protocol detailed.

8.1 I²C standard communication protocol introduced

8.1.1 I²C introduction to C-bus

Another form of AM2321 processor and micro controller interface is I²C serial bus, in this brief introduction about the I²C bus protocol standards. Due to space limitations, can't list all the contents of the agreement deeper questions, please consult the relevant information (refer to the Philips website access).

8.1.2 I²C Bus Overview

Philips (Philips) at 20 years ago invented a simple two-wire bidirectional serial communication bus, the bus is called the Inter-I²C bus. Currently I²C bus has become the industry standard solution for embedded application, is widely used in a variety of professional-based micro controller, consumer and telecommunications products, as a control, diagnostics and power management bus. Multiple matches I²C bus standard devices can communicate via the same I²C bus, without the need to address decoder.

I²C bus require only the two signal lines, a serial data line SDA, the other is a serial clock line SCL. I²C bus devices generally have their SDA and SCL pins are open-drain (or open collector) output structure. Therefore, actual use, SDA Figure 4: AM2321 wiring diagram and SCL signal lines must add pull-up resistors (Rp, Pull-Up Resistor). Value pull-up resistor is generally 3 ~ 10 kΩ. Therefore, when the bus is idle, the two signal lines remain high, almost no current consumption; electrical compatibility, and supports a variety of different voltage logic device interfaces; may be directly connected between the two buses, not require additional conversion circuitry to support a variety of communication more from a major is the most common means of communication. It also supports dual-host communication, multi host communication and broadcast mode, etc.

I²C typical configuration shown in Figure 5.

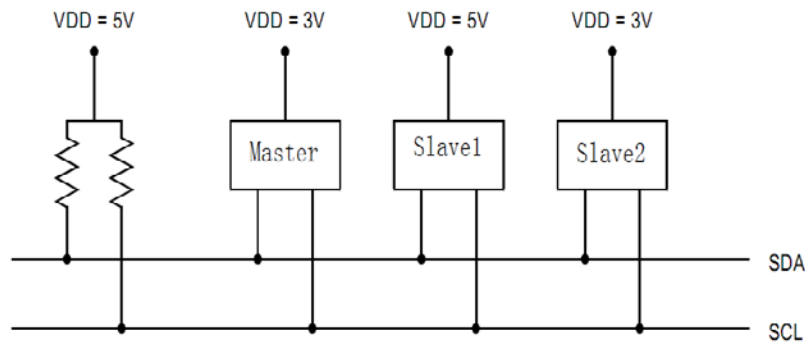

Figure 5: I²C typical configuration

8.1.3 I²C bus protocol specification

◎I²C Bus Definition of Terms

I²C bus connection via the serial data (SDA) and serial clock (SCL) lines on the bus, so that each device to transmit information between the device has a unique address recognition, and can be used as a transmitter or receiver (the device's functions decision), the device when performing data transfers can also be seen as a master or slave, the master is initialized data transmission device allows the transmission bus and generates a clock signal. At this time, any device addressed is considered a slave. I²C bus terms are defined in detail in Table 5.

◎I²C-bus transfer rate

I²C bus communication rate controlled by the host, to fast to slow. However, the maximum rate is limited, the transfer rate on a I²C bus data in standard mode speeds up to 100Kb / s.

◎I²C Bus bit transmission

I²C bus bit transmitted through the data line SDA and SCL clock line two lines together to complete. During high clock line SCL and SDA data line represents the current transmission is low logic level "0"; during high clock line SCL and SDA data line is high logic level represents the current transmission "1." Logic "0" (low) and "1" (high) level, is related to the level of VDD decision (detailed in Table 3 AM2321 DC Characteristics table). In addition, each transmission of a data bit clock pulse is generated.

Term	Description
Transmitter	Send data to the device bus
Receptor	Device receiving data from the bus
Host computer	Transmit clock signal generating device initialization and termination sent

Slave	The device addressed by the host
Multi-master	At the same time there is more than one host attempts to control the bus, but do not destroy the message
Arbitration	There is a multiple hosts at the same time try to control the bus, but only allows it a control bus and make the message is not destroyed in the process
Synchronous	Two or more devices in the process of synchronizing the clock signal

© **Data validity**

Data line SDA data must remain stable during the high period of the clock. High or low state of the data line SDA is only in the low period of SCL clock line only allowed to change. But at the start and end I²C bus exceptions (for details see the start and stop conditions). Some other serial bus data as may be required valid edge (rising or falling) of the clock signal, but I²C bus is valid level. The specific timing diagram shown in Figure 6.

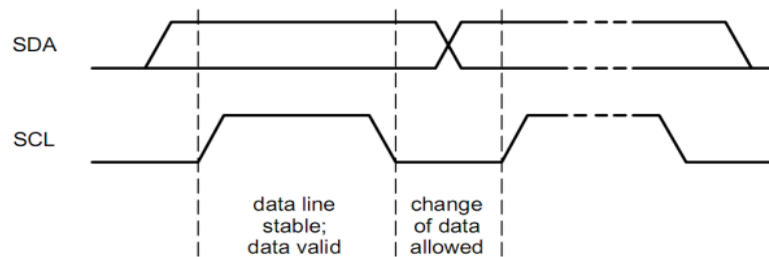

Figure 6: Bit Transfer C bus

© **Start and stop conditions**

Start condition: Period when SCL is high, SDA high to low Start condition generating transition from. Bus after the start condition is generated in a busy state. The initial condition is often abbreviated as S.

Stop condition: Period when SCL is high, SDA generates a stop condition low to high transition from. Bus stop condition is generated in an idle state. The stop condition abbreviated as P.

Start and stop conditions diagram shown in Figure 7.

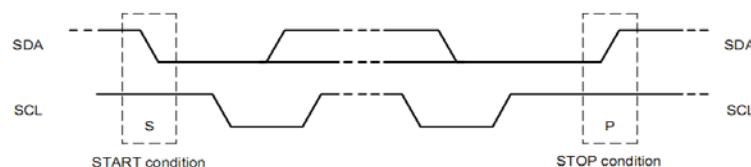

Figure 7: Schematic start and stop conditions

© **Byte transfer format**

I²C bus to send and receive data in bytes. Each byte is transmitted to the SDA line must be 8. The number of bytes per transfer is unrestricted. First, is the highest transmission bit data (MSB bit

7), the last transmission is lowest (LSB, bit 0). Also must be followed by an acknowledge bit after each byte (ACK). C transmission data shown in Figure 8.

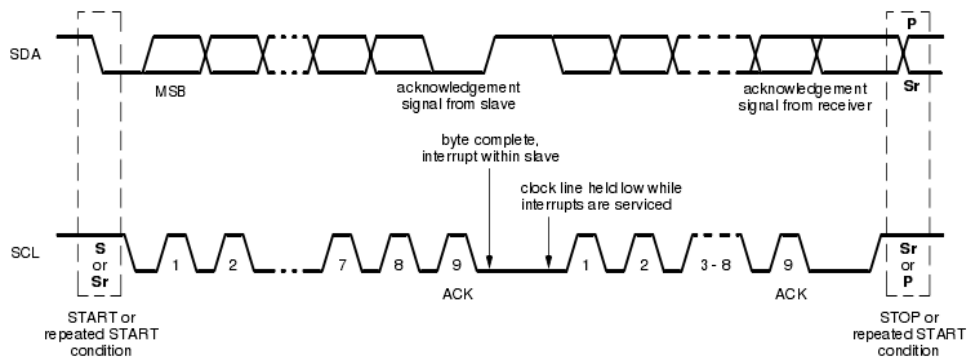

Figure 8: Data Transfer I2C bus

©I²C-bus response

In the I²C bus data transfer process, one byte per transmission, must acknowledge with a status bit. Receiving reception data to inform the transmitter can acknowledge bit. Acknowledge bit hosts still generated clock pulse, and acknowledge the state of the bit data follow the principle of "Who receives who produce", that always generates acknowledge bit by the receiver, the receiver clock pulse response during the SDA line must be low, making it a high level during this clock pulse is stable low (see Figure 9), of course, setup and hold times must be considered (for details please refer to table 6). When sending data from the host to the machine, generating an acknowledge bit from the slave; master data received from the slave, the master generates an acknowledge bit.

I²C bus standards: Acknowledge bit 0 indicates the receiver acknowledge (ACK), often abbreviated as A; it is a representation of non-response (NACK), often abbreviated as NA. The transmitter then sends LSB, should release the SDA line (pull SDA), in order to wait for the receiver generates an acknowledge bit.

If the receiver is receiving at the time of completion of the last byte of data, or can't receive more data should be generated to notify the non-response signal transmitter. If you find a receiver transmitter generates a non-responder status, you should send a termination.

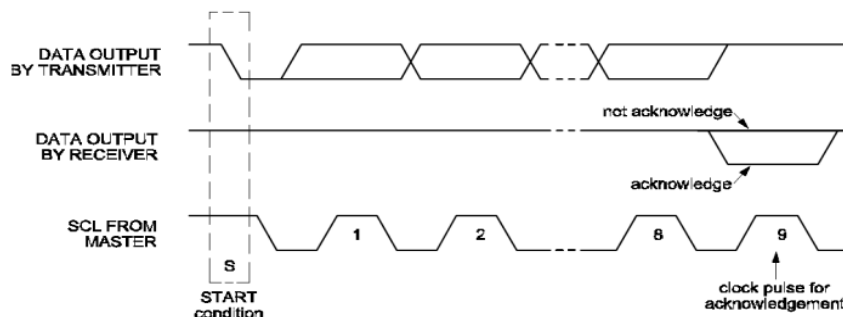

Figure 9: C bus Response

©Slave Address

I²C bus does not additional address decoder and chip select signals. Multiple with I²C bus

interface devices can be connected to the same I²C bus, through the device address to distinguish between them. I²C bus addressing procedure is usually starting at the first byte determines the conditions to choose which one from the host machine, the seven addressable address (the other is a 10-bit addressing addresses differ the sensor uses seven addressable address). Bit of the first byte of the definition shown in Figure 10, the first seven constitute the slave address, the least significant bit (LSB) is the first 8. It determines the direction of the packet, the lowest bit of the first byte (LSB) is "0": Indicates that the host will write information to the selected slave; "1" indicates that the host will read information from the machine to.

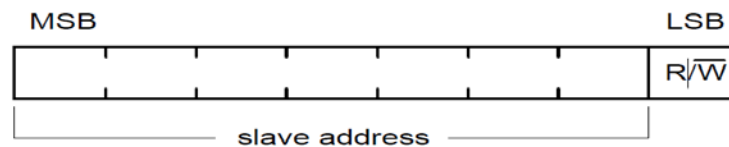

Figure 10: The first byte after the START condition

After sending an address, each device in the system after the initial conditions, the head seven comparison with its own address, if different, the device will think it is the host address, as a slave on the receiver or from a machine the transmitter consists of R / W bits. The host is the master device, it does not require the device address, other devices are all slaves, to have the device address. Must ensure that the same I²C bus address all slaves are uniquely determined, can't be duplicated, otherwise I²C-bus will not work properly.

©The basic data format diagram

Figure 11, Figure 12 shows the basic format of each of I²C transmission and reception of data. It should be noted that the situation in Figure 11 and Figure 12 is different, in Figure 11, the host at the time of sending the last byte of data to the slave, the slave may also be a non-answer answer, but in any case the host can generate stop condition. If the host sends data to the machine (even including slave address) from the detection of non-response from the machine, you should promptly stop transmission.

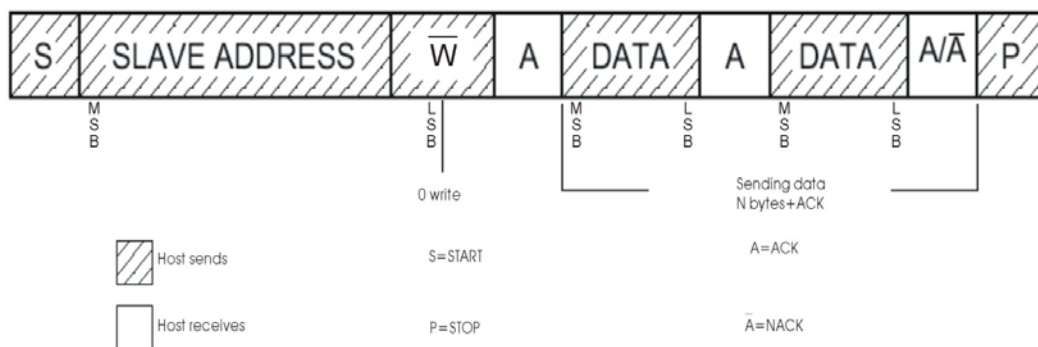

Figure 11: C bus master sends the data to the machine from the basic format

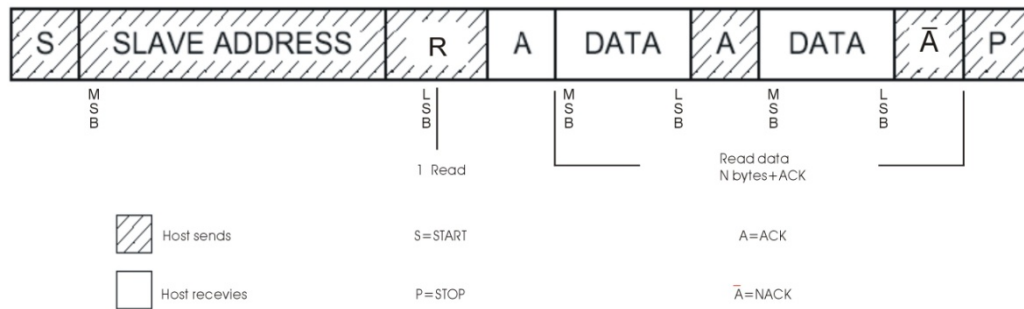

Figure 12: I²C bus master basic format for receiving data from a machine

8.2 AM2321 sensor I²C communication protocol

AM2321 serial interface for the I²C bus, in full accordance with I²C standard protocols addressing, can be directly linked to the I²C bus. AM2321 sensor I²C address of the c(SLAVE ADDRESS) 0xB8, on the basis of I²C standard protocol on the bus, based on Mod Bus protocol, developed a unique communication protocol, reducing the transmission error rate. When micro controller read AM2321 sensors strict accordance with AM2321 sensor I²C -Mod Bus communication protocol design and timing.

8.2.1 I²C Interface Description

AM2321 digital temperature and humidity sensor as a communication from the machine, and the host (user microprocessor) between uses the standard I²C bus mode. For the accurate measurement of humidity, temperature and humidity to reduce the impact of, AM2321 sensors during non-working, automatically become dormant, in order to reduce public consumption, to reduce the impact sensor self-heating of the ambient humidity values. AM2321 uses passive mode, which hosts the wake sensor by instruction, and then send the appropriate commands to read the appropriate temperature and humidity values; After the communication, the sensor triggers a temperature and humidity acquisition; Therefore, if there is no time to read the sensor, please read two consecutive second sensor (minimum interval of two reads 2s), is the latest in a second measurement; after the acquisition sensor automatically become dormant. The next time you need to read the host sensor, sensors need to reawaken. It should be noted that the host communication from start to finish, for a maximum of 3s. If communication is not completed within 3s, sensors automatically end communication, automatically become dormant again as the host read sensors, needed to re-send a wakeup command.

8.2.2 interface Features

This section describes the I²C interface characteristics AM2321 sensor, if you want to get the best communication with the sensor results, designed in strict compliance with the conditions of Figure 13 and Table 6 design.

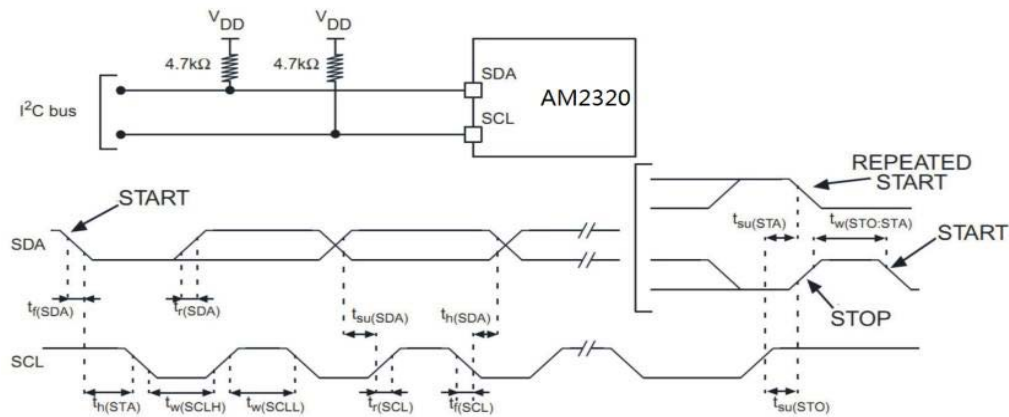

Figure 1 13 3: AM2321 typical application circuit I2C bus and timing diagram

Table 6 : AM2321 sensor C interface characteristics

Symbol	Parameters	Standard C mode		Unit
		min	Max	
SCL clock frequency			100	kHz
T w (SCLL)	SCL Clock low time	4.7		μ s
T w (SCLH)	SCL Clock high time	4.0		
T s u (SDA)	SDA Settling time	250		ns
T h (SDA)	SDA Data hold time	0 ^[1]		
T r (SDA) T r (SCL)	SDA and SCL Rise time		1000	
T f (SDA) T f (SCL)	SDA and SCL Fall Time		300	
T h (STA)	Start condition hold time	4.0		μ s
T s u (STA)	Repeated Start condition setup time	4.7		
T s u (STO)	Stop condition setup time	4.0		μ s
T w (STO:STA)	Stop to Start condition time (bus idle)	4.7		μ s
C b	Capacitive load for each bus		400	P F

8.2.3 Communication protocol

I²C protocol AM2321 sensor is based on the standard I²C bus protocol, the reference to the Mod Bus protocol, according to AM2321 sensor itself features a combination of I²C Mod Bus agreement. Specific format is as follows:

© Communication data (information frame) format

Data formats:	I ² C data+W/R	Function Code	Data Area	CRC
Data length:	1byte	1 byte	N-byte	16-bit CRC (cyclic redundancy code)

© Communication and information transfer process

When a command is sent by the sending communication device (host) to the sensor, the

command line with the sensor address, the sensor was to receive, and read the information in accordance with the function codes and requirements; then the results (data) is sent back to the host. The information returned includes the function code, and after execution of the data CRC code (the user may read the CRC, can be sent directly to a stop condition).

◎ **Communication slave address**

AM2321 sensors each address are the same, and is 0xB8. So on the same bus can only hang the AM2321 sensors, sensor signal only after receiving the start and with itself will respond to the same address.

◎ **Communication I²C function code**

Function code is the first byte of each communication message frame transmission. I²C _Mod Bus communication rules, define the function code is 1-127. As host requests sent by function code tells the slave what action should be performed. As a slave response, the slave returns the function code sent from the host to the function code, as it indicates that the response from the host machine and have been related operations. I²C _Mod Bus part of the function codes are listed in Table 7.

Table 7: C Mod Bus part of the function code

Function Code	Definitions	Operation (binary)
0x03	Reading Register Data	Read one or more data registers
0x10	Write Multiple Registers	Multiple sets of binary data to write multiple registers

◎ **C communication data area**

The data area includes required by the sensor returns what information or what action to perform. This information may be data (such as: temperature, humidity, the sensor device information, the user writes data, etc.), the reference address. For example, function code 03 tells the host through the register value returned by the sensor (including the start address of the register to be read and the read length register), the returned data comprises data length and the content of the register data register.

Sensor uses a custom I²C-Mod bus communication protocol used by the master communication command (function code 03), which could be read its data register, the data register table in Table 8. Sensor data register stores the temperature and humidity values and the corresponding sensor device information and other related signals; each data register is a single byte (8 bits) of binary data; once read data up to 10 sensor registers more than read length, the sensor will return the corresponding error code. The error code information, see Schedule 1.

Table 8: AM2321 Data Register Table

Register information	Address	Register information	Address	Register information	Address	Register information	Address
High humidity	0x00	Model High	0x08	Users register a high	0x10	Retention	0x18
Low humidity	0x01	Model Low	0x09	Users register a low	0x11	Retention	0x19
High temperature	0x02	The version number	0x0A	Users register 2 high	0x12	Retention	0x1A
Low temperature	0x03	Device ID (24-31) Bit	0x0B	Users register 2 low	0x13	Retention	0x1B

Retention	0x04	Device ID (24-31) Bit	0x0C	Retention	0x14	Retention	0x1C
Retention	0x05	Device ID (24-31) Bit	0x0D	Retention	0x15	Retention	0x1D
Retention	0x06	Device ID (24-31) Bit	0x0E	Retention	0x16	Retention	0x1E
Retention	0x07	Status Register	0x0F	Retention	0x17	Retention	0x1F

◎ **Temperature output format**

Temperature resolution is 16Bit, temperature highest bit (Bit15) is equal to 1 indicates a negative temperature, the temperature highest bit (Bit15) is equal to 0 indicates a positive temperature; temperature in addition to the most significant bit (Bit14 ~ Bit0) indicates the temperature sensor string value. Temperature sensor value is a string of 10 times the actual temperature value.

◎ **Status Register**

Status Register, Bit7-Bit0 bit, temporarily reserved

Status register bits	Bit7	Bit6	Bit5	Bit4	Bit3	Bit2	Bit1	Bit0
Features	Retention	Retention	Retention	Retention	Retention	Retention	Retention	Retention

◎ **I² C Mod Bus Function Code Description**

1. Function code "03": Read registers multiplexed sensor

The host sends reading frame format:

START + (I² C address + W) + function code (0x03) + start address + number of registers + STOP

Host read return data:

START + (I² C address + R) + sequential read sensor data returned + STOP

Sensor response frame format:

Function code (0x03) + number + data +CRC^[1]

For example: Host sequential read sensor data: the starting address for the register data of four sensors 0x00.

Sensor data register address and data:

Register Address	Register data	Data Description	Register Address	Register data	Data Description
0x00	0x01	High humidity	0x02	0x00	High temperature
0x01	0XF4	Low humidity	0x03	0xFA	Low temperature

Host message format sent:

The host sends	Byte count	Transmitting information	Remarks
Sensor address	1	0xB8	Sensor C address (0xB8) + W (0)

Function Code	1	0x03	Read register
Starting address	1	0x00	Register start address is 0x00
Number of registers	1	0x04	Read the number of register

Sensor response message format returned:

Slave response	Byte count	Transmitting information	Remarks
Function Code	1	0x03	Read register
Returns the number of bytes	1	0x04	Returns 4 of 4 byte register
Register 1	1	0x01	Address for the content of 0x00 (high humidity bytes)
Register 2	1	0XF4	Address for the content of 0x01 (low humidity bytes)
Register 3	1	0x00	Address for the content of 0x01 (low humidity bytes)
Register 4	1	0XFA	Address for the content 0x03 (temperature low byte)
CRC code	2	31A5	Sensors calculate the CRC code returned, low byte first;

Numerical calculation:

From the temperature and humidity sensor value is read back, as long as the value into decimal number 10 is divided by the corresponding values of temperature and humidity, corresponding temperature unit °C, humidity unit is% RH. Such as the above data read back:

Humidity: 01F4 = $1 \times 256 + 15 \times 16 + 4 = 500 \Rightarrow$ humidity = $500 \div 10 = 50.0\%RH$;

Temperature: 00FA = $15 \times 16 + 10 = 250 \Rightarrow$ temperature = $250 \div 10 = 25.0^\circ C$ Note: CRC verification code calculated by the CRC code drawn, then the sensor on the transmission of CRC codes ratio; same, then that data is received correctly, otherwise that data has errors.

2. Function code "10": Write multiple registers to sensor

Host code can use this feature to save multiple data storage sensor. Single AM2321 sensor register is a byte, or 8 bits. Sensor allows you to save a maximum of 10 data registers. Thus, the single most host to the sensor to save up to 10 registers. Over 10, the sensor will return the corresponding error code.

The host sends the write frame format:

START + (I²C address + W) + function code (0x10) + start address register number + save data + CRC + STOP

The host reads the confirmation instruction:

START + (I²C address + R) + read sensor data returned + STOP

Sensor response frame format:

Function code (0x10) + start address + number + CRC register

For example: The host should be saved to address 10,11 ,01,02 sensors to register.

The host sends	Byte count	Transmitting information	Remarks
Sensor address	1	0XB8	Sensor C address (0xB8) + W (0)
Function Code	1	0x10	Write Multiple Registers

Starting address	1	0x10	Start address of the register to be written
Save word length	1	0x02	Save the data word length (2 words)
Save Data1	1	0x01	Save the data (address: 10)
Save Data2	1	0x02	Save the data (address: 11)
CRC code	2	C092	Host calculated CRC code, low byte first(C addresses are not included in the CRC calculation)

Host message format sent:

Slave response	Byte count	Transmitting information	Remarks
Function Code	1	0x10	Write Multiple Registers
Starting address	1	0x10	Starting address saved
Save the data length	1	0x10	Save the data length sensor
CRC code	2	0x10	Sensors calculate the return CRC code, low byte first

Sensor response message format returned:

◎CRC checksum

Host or sensors available checksum discriminate receiving information is correct. As electronic noise or some other interference during the transmission of information is sometimes an error occurs, the error check code (CRC) can test the host or sensor information in the communication data transfer process is wrong, wrong data can give (either sending or receiving), thus increasing the safety and efficiency of the system.

CRC I²C-Mod Bus communication protocol (cyclic redundancy code) contains two bytes, or 16-bit binary number. CRC code by the sending device (host) calculations, send the information placed in the rear frame, I²C address is not included in the CRC calculation. Whether sending or receiving CRC are by the low byte first, high byte format for transmission in the post. Receiving information on the device (sensor) to recalculate the information received CRC, the CRC is calculated by comparing the received query, and if they do not match, then the error. Users need special attention, reading sensor command without adding the CRC; writing sensors must be added the CRC; and all the return data are CRC.

◎CRC code calculation method

1. Preset a 16-bit register hexadecimal FFFF (including 1); said this register for the CRC register;
2. The low (first byte frames both communications and information) first 8-bit binary data with 16-bit CRC register eight or different, the results put in CRC register;
3. The contents of the CRC register right one (towards low) with zeros to fill the highest position, and check out bit right after;
4. If the bit is 0 out: Repeat steps (the right one again) 3; If the bit is shifted 1: CRC register with the polynomial A001 (1010 0000 0000 0001) XOR;
5. Repeat steps 3 and 4 until the right eight times, so that the entire eight were processed all the data;
6. Repeat steps 2 through 5, the communication of information to the next frame byte

processing;

7. The communication message frame after all the bytes calculated according to the above steps completed, the high and low byte of the resulting 16-bit CRC register exchange;

8. The resulting CRC register contents is: CRC code.

©CRC calculation code in C language code

Description: This program to calculate the length len * ptr bytes before the CRC.

```
unsigned short crc16(unsigned char *ptr, unsigned char len)
{
    unsigned short crc =0xFFFF;
    unsigned char i;
    while(len--)
    {
        crc ^=*ptr++;
        for(i=0;i<8;i++)
        {
            if(crc & 0x01)
            {
                crc>>=1;
                crc^=0xA001;
            }else
            {
                crc>>=1;
            }
        }
    }
    return crc;
}
```

8.2.4 I²C Communication Timing

AM2321 sensor I²C communication, although according to the standard I²C communication sequence, but must follow our communication protocols and communication timing requirements, in order to accurately read the sensor. In strict accordance with the communication protocol and timing, please read the design.

©I²C Read full Timing Example

Figure 14 shows the read sensor when the full sample and write a special time requirements, in strict accordance with the requirements of the special time to read and write, otherwise it will appear unreadable sensors or incorrect data and so on. Several timing diagram special needs attention, the time requirements detailed in Figure; host communication from beginning to end, for a maximum of 3S.

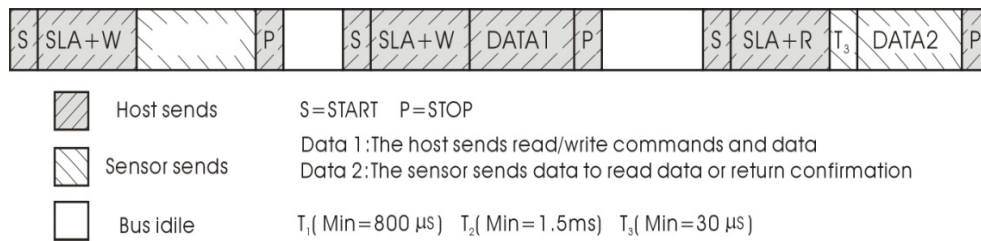

Figure14: I² C sensors read the complete example of fig

◎I² C read and write timing decomposition

Sensors read or write, you must follow these three steps, otherwise it will not communicate or can't read the correct data:

Step one: Wake Sensor

In order to reduce the humidity sensor errors caused by self-heating, the sensor in a non-working state, dormant, so to read the sensor must wake sensor to transmit commands to read and write, otherwise the sensor will not respond. It should be noted that, in the wake sensor, I² C address is sent, the sensor does not respond to ACK, but the host must send back an ACK clock verify that the ninth SCL clock signal. Wake sensor operation is following instructions:

After the host sends a start signal is applied to the starting address, wait for sometime (waiting time of at least 800 μs, the maximum 3ms; such as host hardware I² C, you do not need to wait for the hardware I² C will automatically wait), and then sends a stop signal.

Namely: the starting signal +0 xB8 + wait (> 800us) + stop signal timing diagram shown in Figure 15.

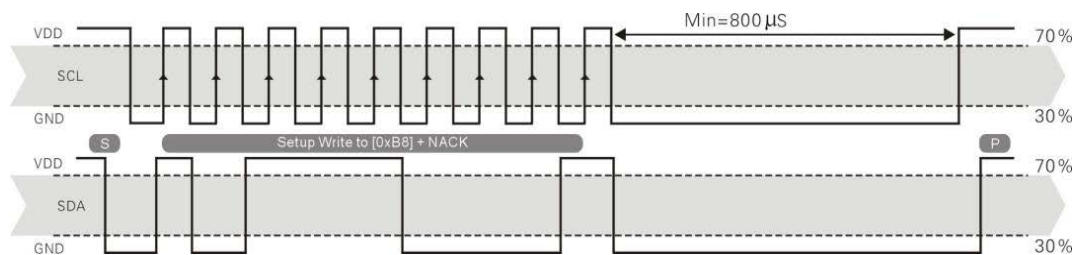

Figure 15: Wake Sensor

Step two : Send the read command or send written instructions

After the wake AM2321 sensors, can be fully in accordance with the standard read and write timing I² C, and the maximum speed supported 100Kb / s. Read the temperature and humidity of example, as shown in Figure 16.

The host sends commands to: START +0 xB8 (SLA) +0 x03 (function code) +0 x00 (starting address) +0 x04 (register length) + STOP

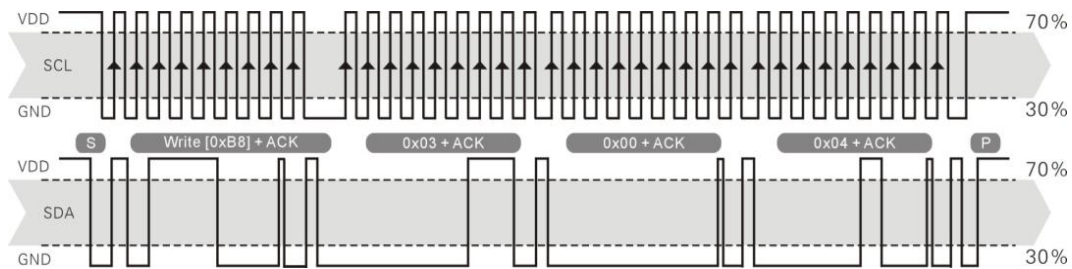

Figure 16: sending a read command example temperature and humidity

Steps three : To return the data read or confirmation signal

Send read / write command, the host is required to wait at least 1.5ms, and then sends a read timing, reads return data example shown in Figure 17; must be noted that, when you read the data, issued after the completion of I²C address, wait at least 30μs and then sent over the next serial clock, reading data, or communication error occurs.

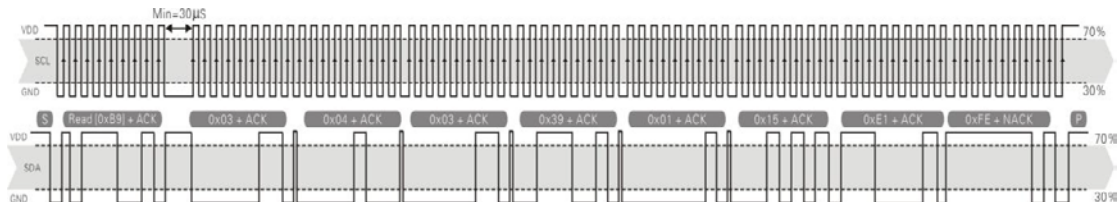

Figure 17: Read the sample temperature and humidity values

Host read back the data as follows:

0x03(Function Code)+0x04(data length)+0x03(high humidity)+0x39(low humidity) + 0x01 (high temperature) +0x15(low temperature)+0xE1(CRC checksum low byte) + 0xFE (CRC checksum high byte);

Therefore: 0339H = 3 × 256 + 3 × 16 + 9 = 825 => humidity = 825 ÷ 10 = 82.5% RH;

0115H = 1 × 256 + 1 × 16 + 5 = 277 => temperature = 277 ÷ 10 = 27.7 °C

These three steps can be completed by the sensor reads all registers, a write operation (the user can write registers, only five, namely the status register, register four users, while the status register can only be written separately, otherwise it will error) ; the user in the design, follow these three steps must be fully read and write.

After sending the sensor data, trigger a temperature and humidity measurements; After the measurement is completed, the recording temperature and humidity values, then completed a communication, the sensor automatically goes to sleep; therefore, as long unread sensors continuously read the second sensor, in the second reading of the temperature and humidity back to the latest value (minimum interval of continuous reading 2S).

8.2.5 Peripheral read flowchart

AM2321 read I²C sensor schematic flow diagram shown in Figure 18, we also provide sample code reads C51, need to download the client, please visit our website (www.aosong.com) associated download, this manual does not provide code instructions.

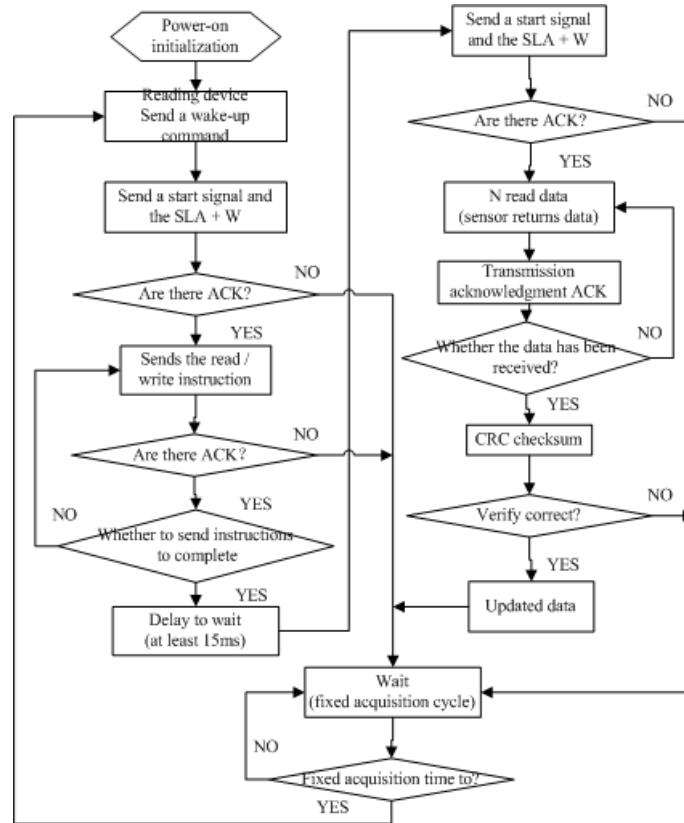

Figure18: The I² C read sensor flowchart

Table 1: I² C_MODBUS communication protocol summary table

<p>Read Bus Description: I² C address is 0xB8; access a maximum of 10 registers;</p> <p>Time to read a communication bus for a maximum of 3 S.</p> <p>Sensor data are added each time you return the CRC, the user can choose not to read the CRC</p>
<p>Read sensor frame format: Host frame format: (SLA + W) + function code (0x03) + start address + number of registers</p> <p>From the machine frame format: function code (0x03) + data length + return data + CRC</p>
<p>Write sensor frame format: Host frame format: (SLA + W) + function code (0x10) + start address register</p>

number + save data + CRC							
From the machine frame format: function code (0x03) + start address + number + CRC							
register							
AM2321 sensors register list:							
Register information	Address	Register information	Address	Register information	Address	Register information	Address
High humidity	0x00	Model High	0x08	Users register a high	0x10	Retention	0x18
Low humidity	0x01	Model Low	0x09	Users register a low	0x11	Retention	0x19
High temperature	0x02	The version number	0x0A	Users register 2 high	0x12	Retention	0x1A
Low temperature	0x03	Device ID (24-31) Bit	0x0B	Users register 2 low	0x13	Retention	0x1B
Retention	0x04	Device ID (16-23) Bit	0x0C	Retention	0x14	Retention	0x1C
Retention	0x05	Device ID (8-15) Bit	0x0D	Retention	0x15	Retention	0x1D
Retention	0x06	Device ID (0-7) Bit	0x0E	Retention	0x16	Retention	0x1E
Retention	0x0F	Status Register	0x0F	Retention	0x17	Retention	0x1F

	7						
<p>Status Register Definition : Bit7-Bit0 bit reserved ;</p>							
<p>Temperature Format: Temperature highest bit (Bit15) is equal to 1 indicates a negative temperature, the temperature highest bit (Bit15) is equal to 0 indicates a positive temperature; temperature in addition to the most significant bit (Bit14 ~ Bit0) indicates the temperature sensor string value.</p> <p>Temperature sensor value is a string of 10 times the actual humidity value;</p>							
<p>Write Sensor: For users to write register (0x0F ~ 0x13); prohibit write other registers and status registers can only be written separately.</p>							
<p>Reader sample:</p>							
	Function	Function Code	Start addresses	Frame data content			
	Read the temperature and humidity	0x03	0x00	Send : (SLA+W)+0x03+0x00+0x04 Return : 0x03 +0 x04 + humidity + high + low temperature and humidity high temperature low + CRC			
	Read the temperature	0x03	0x02	Send : (SLA+W)+0x03+0x02+0x02 Return : 0x03+0x02+High temperature + low temperature+ CRC			
	Read humidity	0x03	0x00	Send : (SLA+W)+0x03+0x00+0x02 Return : 0x03+0x02+High humidity+ Low humidity + CRC			
	Reading Device Information	0x03	0x08	Send : (SLA+W)+0x03+0x08+0x07 Return : 0x03+0x07+Model (16) + version number (8) + ID			

			(32-bit)+CRC
Write Status Register	0x10	0x0F	Send : (SLA+W)+0x10+0x0F+0x01+0x01+0xF4(Low)+0xB7(High) Note : Function code + register start address + register number + save content+ CRC
			Return : 0x10+0x0F+0x01+0xB4 (Low Byte) +0x35 (High Byte) Note : Function code + number + register start address register+ CRC
Write a user registers a	0x10	0x10	Send : (SLA+W)+0x10+0x10+0x02+0x01+0x02+0xC0+0x92
			Return : 0x10+0x10+0x02+0xFC+0x04

Note: SLA = I2C address 0xB8. Table CRC parity bit, CRC was 16, the low byte first, high byte.

Return error code: 0x80: not support function code 0x81: Read an illegal address 0x82: write data beyond the scope

0x83: CRC checksum error 0x84: Write disabled.

8.3 Single bus communication (ONE-WIRE)

8.3.1 Single bus typical circuit

Connection with the AM2321 microprocessor typical application circuit shown in Figure 19. When single-bus communication mode, after pulling the SDA microprocessor I / O ports are connected.

Single bus communication Special Instructions:

1. A typical application circuit recommended cable length shorter than 30 meters with a 5.1K pull-up resistor when greater than 30 meters when the pull-up resistor to reduce the actual

situation.

2. 3.3V voltage supply is recommended when the cable length is not greater than 1m. Otherwise, line drop may cause the sensor communication error.

3. The minimum interval of the read sensor 2S; reading interval is less than 2S, temperature and humidity might result in denial or communication is unsuccessful and so on.

4. Temperature and humidity values are read out every last measurement result, want to get real-time data, the need to continuously read twice, repeatedly suggested reading sensor, and each sensor reading interval greater than 2 seconds to obtain accurate data.

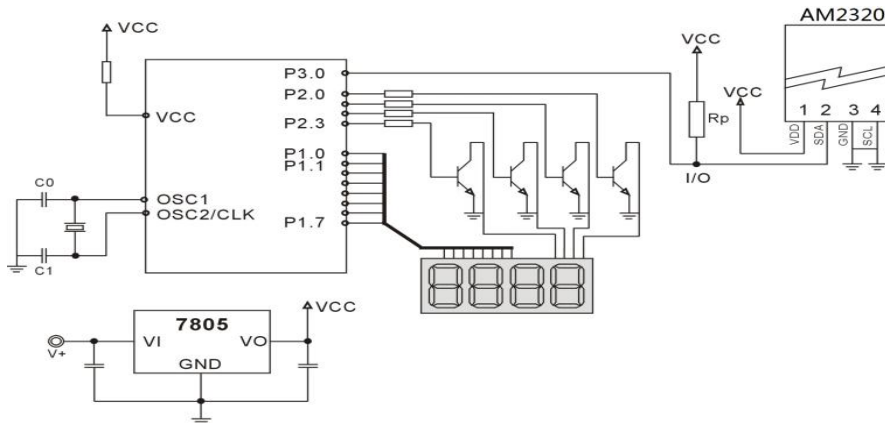

Figure 19: AM2320 single bus typical circuit

8.3.2 Single bus communication protocol

◎ Single Bus Description

AM2321 device uses a simplified single-bus communication. Single bus that only one data line, the data exchange system, the control by the data line is completed. Device (microprocessor) through an open-drain or tree-state port is connected to the data line to allow the device when not transmitting data to release the bus, and let other devices use the bus; single bus usually requires an external 5.1kΩ of approximately pull-up resistors, so that when the bus is idle, the state is high. Because they are master-slave structure, only when the host calls the sensor, the sensor will be answered, so the host access to the sensor must strictly follow the sequence of a single bus, if there is a sequence of confusion, the sensor will not respond to the host.

◎ Single bus transfer data definitions

SDA and AM2321 microprocessors for communication and synchronization between using single bus data format, a 40-bit data transfer, high first-out. , The communication format specific communication sequence shown in Figure 20 are shown in Table 9.

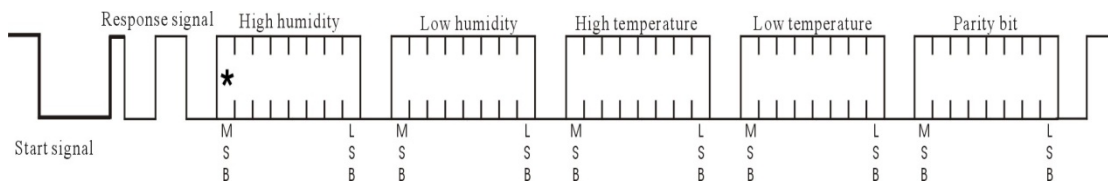

Figure 20: AM2321 single bus communication protocol

Table 9: AM2321 communication format

Name	Single bus format definition
Start signal	The microprocessor data bus (SDA) low period (at least 800 μ s) ^[1] , to prepare the data notification sensor
Response signal	Sensor data bus (SDA) low 80 μ s, 80 μ s followed by a high signal in response to the initial host
Data Format	Upon receipt of the host start signal from the data bus disposable sensor (SDA) string of 40-bit data, the high first-out
Humidity	Humidity resolution is 16Bit, the previous high; strings out of the humidity sensor is 10 times the actual humidity values.
Temperature	Temperature resolution is 16Bit, the previous high; sensor string temperature value is 10 times the actual temperature value; Temperature highest bit (Bit15) is equal to 1 indicates a negative temperature, the temperature highest bit (Bit15) is equal to 0 indicates a positive temperature; In addition to the temperature of the highest bit (Bit14 ~ Bit0) indicates the temperature value.
Parity bit	Parity bit = humidity high temperature + humidity + high + low temperature low

[1] For details, see 7.3

◎ Single bus data sample calculation

Example 1: 40 of the received data:

0000 0010 1001 0010 0000 0001 0000 1101 1010 001 High humidity
8 Low humidity 8 High temperature 8 Low temperature8 Parity bit

Calculated as follows:

0000 0010+1001 0010 +0000 0001+0000 1101= 1010 0010 (Parity bit)

Receive data is correct:

Humidity:0000 0010 1001 0010 = 0292H (hex) = $2 \times 256 + 9 \times 16 + 2 = 658 \Rightarrow$ Humidity = 65.8% RH

Temperature:0000 0001 0000 1101 = 10DH (hex) = $1 \times 256 + 0 \times 16 + 13 = 269$
 \Rightarrow Temperature = 26.9 $^{\circ}$ C

◎ Special Instructions:

When the temperature is below 0 $^{\circ}$ C temperature data for a top position.

Example One: -10.1 $^{\circ}$ C expressed as 1,000,000,001,100,101

Temperature: 0000 0000 0110 0101 = 0065H (hex) = $6 \times 16 + 5 = 101$
 \Rightarrow Temperature = -10.1 $^{\circ}$ C

Example Two: The received data 40:

0000 0010 1001 0010 0000 0001 0000 1101 1011 0010
High humidity 8 Low humidity 8 High temperature 8 Low temperature8 Parity bit

Calculated as follows:

0000 0010+1001 0010 +0000 0001+0000 1101=1010 0010 \neq 1011 0010 (Parity error)

The received data is not correct, give up, again receiving data.

8.3.3 Single-bus communication timing

Hosts (MCU) sends a start signal (data bus SDA low for at least 800 μ s) After, AM2321 transition from sleep mode to high-speed mode. After completion, the master start signal, AM2321

transmit a response signal, the data sent from the data bus 40Bit SDA serial high byte is transmitted first; data is sequentially transmitted high humidity, low humidity, high temperature, low temperature, the parity bit , sent a message to trigger the end of data collection, collecting sensor automatically transferred to the end of the sleep mode until the next traffic coming.

Detailed timing signal characteristics are shown in Table 10, a single bus communication timing diagram shown in Figure 21.

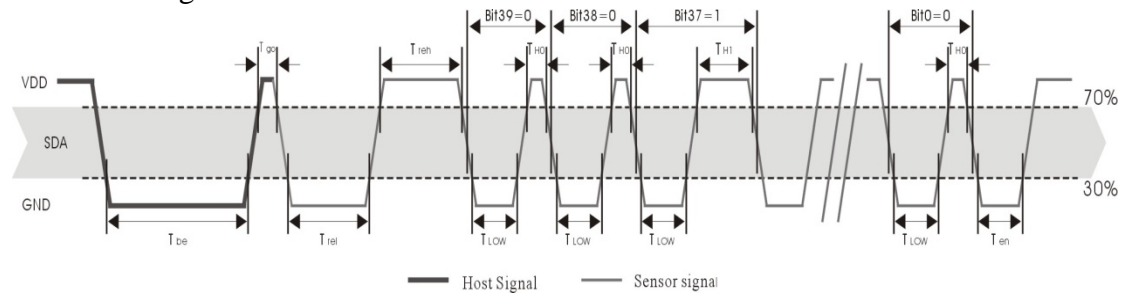

Figure 21: AM2321 single bus communication timing

Note: The temperature and humidity data from the AM2321 host always read the previous measurement, the measurement interval twice as long, please read twice in a row is the second time in the real-time temperature and humidity values, while two read take a minimum interval 2S.

Table 10 : single bus signal characteristics

Symbol	Parameter	min	typ	max	unit
T _{be}	Host starting signal low time	0.8	1	20	ms
T _{go}	Host Bus release time	20	30	200	μ S
T _{rel}	Response time low	75	80	85	μ S
T _{reh}	Response time high	75	80	85	μ S
T _{low}	Signal "0", "1" low time	48	50	55	μ S
T _{h0}	Signal "0" High Time	22	26	30	μ S
T _{h1}	Signal "1" High Time	68	70	75	μ S
T _{en}	Sensor releases the bus time	45	50	55	μ S

Note: To ensure accurate communication of the sensor, the user when reading the signal, in strict accordance with Table 10 and Figure 21, the design parameters and timing

8.3.4 Peripheral reading step example

Communication between the host and the sensor reads the data can be done through the following three steps.

Step One:

AM2321 after power (power after AM2321 2S to wait to cross the unstable state, during the reading device can not send any commands), test environment temperature and humidity data, and record the data, then the sensor automatically transferred to a dormant state. The SDA data line AM2321 by resistance and pulling high has been to maintain a high level, then the AM2321 SDA pin is in the input state, always detect external signals.

Step Two:

Microprocessor I / O is set to output, while the output low and low retention time can't be less than 800us, typical values are pulled 1MS, then the microprocessor I / O is set to enter the state, the release of the bus, Since the pull-up resistor, the microprocessor I / O data lines that AM2321 the SDA also will go high, and so the host releases the bus, AM2321 sends a response signal, the output

low as 80 microseconds response signal, followed by 80 microsecond high output peripheral is ready to receive data notification signal transmitter 22 shown in fig.

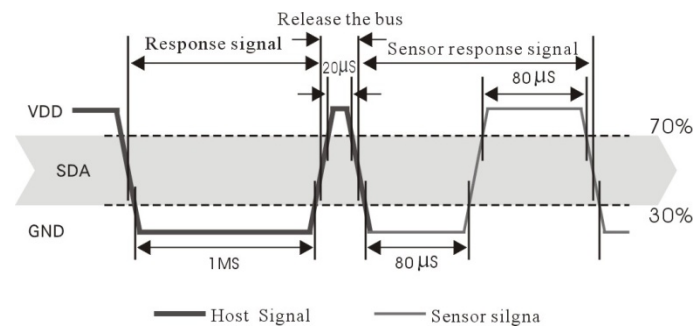

Figure 22: Single-bus timing diagram decomposition

Step Three:

AM2321 After sending the response, followed by a continuous serial data bus SDA data output 40, the microprocessor 40 receives the data according to I / O level changes.

Bit data "0" in the form: low high 50 microseconds plus 26-28 microseconds;

Bit data "1" format: LOW HIGH plus 70 microseconds 50 microseconds;

Bit data "0", the bit data "1" signal format shown in Figure 23.

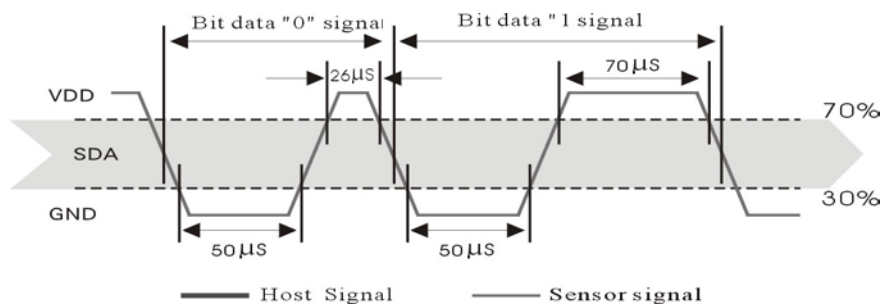

Figure 23: Single-bus timing diagram decomposition

Data bus SDA AM2321 output 40-bit of data , the continued output low 50 microseconds after the entry into the state, due to the pull-up resistor attendant goes high. Meanwhile AM2321 retest internal temperature and humidity data, and record data, test recording ends, the micro controller automatically goes to sleep. Only after receipt of the start signal micro controller host, only to re-awaken the sensor, enter the working state.

8.3.5 Peripheral read flowchart

AM2321 sensor reads a single bus flowchart diagram shown in Figure 24, we also provide sample code reads C51, need to download the client, please visit our website (www.aosong.com) associated download, this manual does not provide code description.

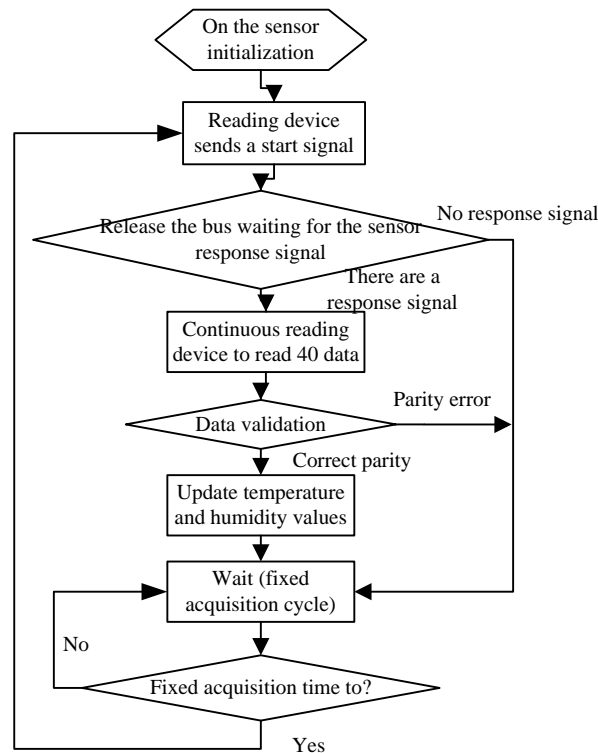

Figure 24: Single-bus read flowchart

9. Application Information

1. Work and storage conditions

The proposed scope of work may result in up to 3% RH temporary drift of the signal. Return to normal working conditions, the sensor calibration status will slowly recover. To speed up the recovery process can be found in "recovery process." The use of the product will accelerate the aging process for a long time under abnormal operating conditions.

Avoid placing components on a long-term condensation and dry conditions and the following environment.

A, salt spray

B, the acid or oxidizing gases such as sulfur dioxide, hydrochloric acid

Recommended Storage Environment

Temperature: 10 ~ 40 °C Humidity: 60% RH or less

2. Effects of exposure to chemical substances

Capacitive humidity sensor sensing layer will be disturbed chemical vapors, chemical diffusion layer in the sensor may cause drift and measurement sensitivity. In a clean environment, slowly release contaminants out. The recovery process described below to accelerate the process. High concentrations of chemical pollution can cause damage to the sensor sensing layer completely.

3. Temperature Effect

Relative humidity of the gas, is largely dependent on temperature. Therefore, when measuring the humidity should be possible to ensure that the humidity sensor works at the same temperature. If you share a printed circuit board with electronic components heat released in the sensor should be installed as far as possible away from the electronic components, and installed at the bottom of the

heat source, while maintaining a well-ventilated enclosure. To reduce the thermal conductivity sensor and a copper plating layer of the printed circuit board should be as minimal other portions, and leaving a gap between them.

4.Light effects

Prolonged exposure to sunlight or strong ultraviolet radiation, will reduce performance.

5.Recovery process

Placed under extreme operating conditions or chemical vapor sensors, through the following process, you can return it to the state calibration. 2 hours at 45°C and < 10% RH humidity conditions(Hong Gan); then at 20-30 °C and > 70% RH humidity under conditions remain more than 5 hours.

6.Wiring Precautions

Affects the communication quality of the signal wire distance and communication quality, we recommend using a high quality shielded cable.

7.Soldering Information

Manual welding, at a temperature of 300 °C maximum contact time must be less than 10 seconds.

8.Product upgrades

For details, please consult our technical department.

10. License Agreement

Without the prior written permission of the copyright holder, shall not in any form or by any means, whether electronic or mechanical (including photocopying), for any part of this manual may be reproduced, nor may its contents be communicated to a third party. The contents are subject to change without notice.

Aosong Electronics Co., Ltd. and the third party has a proprietary software, the user may use only the signing of a contract or license the software.

11. Warnings and personal injury

Do not use this product as safety or emergency stop devices, as well as due to the failure of the product could result in personal injuries to any of the other applications. The product shall not apply unless there is a particular purpose or use authorization. Before installation, handling, use or maintenance of the product to the reference product data sheets and application notes. Failure to comply with this recommendation, that may result in death or serious injury, the resulting company will not be liable for all damages in personal injury and death, and thus exempt from corporate managers and employees and affiliated agents, distributors providers and any other claims that may arise, including: a variety of costs, compensation costs, legal fees and so on.

12. Quality assurance

The company provides a period of 12 months (one year) quality assurance (calculated from the date of shipment from) their direct purchasers of the product. Data sheet of the company published the technical specifications of the product shall prevail. If the warranty period, the product is proved to be defective quality, the company will provide free repair or replacement. Users must satisfy the following conditions:

- ① The product is found defective within 14 days written notice to the Company;
- ② The product should be returned to the purchaser to pay the company;
- ③ the shelf life of the product should.

The company only for those applications where the product meets the technical conditions arising from defective product. Company for its products in those particular applications without any guarantee, warranty or written statement. The company applied to the product or its products reliability of the circuit does not make any promises.