

P-Channel 20-V (D-S) MOSFET

These miniature surface mount MOSFETs utilize High Cell Density process. Low $r_{DS(on)}$ assures minimal power loss and conserves energy, making this device ideal for use in power management circuitry. Typical applications are PWMDC-DC converters, power management in portable and battery-powered products such as computers, printers, battery charger, telecommunication power system, and telephones power system.

- Low $r_{DS(on)}$ Provides Higher Efficiency and Extends Battery Life
- Miniature TO-252 Surface Mount Package Saves Board Space
- High power and current handling capability
- Extended VGS range (± 25) for battery pack applications

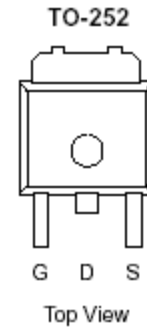
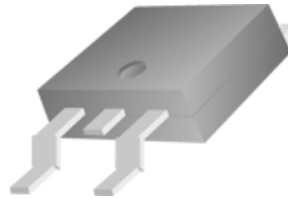

PRODUCT SUMMARY		
V _{DS} (V)	r _{DS(on)} m(Ω)	I _D (A)
-20	20 @ V _{GS} = -4.5V	41
	35 @ V _{GS} = -2.5V	31

ABSOLUTE MAXIMUM RATINGS (T _A = 25 °C UNLESS OTHERWISE NOTED)			
Parameter	Symbol	Maximum	Units
Drain-Source Voltage	V _{DS}	-20	V
Gate-Source Voltage	V _{GS}	±12	
Continuous Drain Current ^a	T _A =25°C I _D	41	A
Pulsed Drain Current ^b	I _{DM}	±40	
Continuous Source Current (Diode Conduction) ^a	I _S	-30	A
Power Dissipation ^a	T _A =25°C P _D	50	W
Operating Junction and Storage Temperature Range	T _J , T _{stg}	-55 to 175	°C

THERMAL RESISTANCE RATINGS			
Parameter	Symbol	Maximum	Units
Maximum Junction-to-Ambient ^a	R _{θJA}	50	°C/W
Maximum Junction-to-Case	R _{θJC}	3.0	°C/W

Notes

- a. Surface Mounted on 1" x 1" FR4 Board.
- b. Pulse width limited by maximum junction temperature

SPECIFICATIONS ($T_A = 25^\circ\text{C}$ UNLESS OTHERWISE NOTED)						
Parameter	Symbol	Test Conditions	Limits			Unit
			Min	Typ	Max	
Static						
Gate-Threshold Voltage	$V_{GS(th)}$	$V_{DS} = V_{GS}, I_D = -250 \mu\text{A}$	-0.7			
Gate-Body Leakage	I_{GSS}	$V_{DS} = 0 \text{ V}, V_{GS} = \pm 25 \text{ V}$			± 100	nA
Zero Gate Voltage Drain Current	I_{DSS}	$V_{DS} = -16 \text{ V}, V_{GS} = 0 \text{ V}$			-1	uA
		$V_{DS} = -16 \text{ V}, V_{GS} = 0 \text{ V}, T_J = 55^\circ\text{C}$			-5	
On-State Drain Current ^A	$I_{D(on)}$	$V_{DS} = -5 \text{ V}, V_{GS} = -4.5 \text{ V}$	-41			A
Drain-Source On-Resistance ^A	$r_{DS(on)}$	$V_{GS} = -4.5 \text{ V}, I_D = -20.5 \text{ A}$			20	m Ω
		$V_{GS} = -2.5 \text{ V}, I_D = -15.5 \text{ A}$			35	
Forward Transconductance ^A	g_{fs}	$V_{DS} = -10 \text{ V}, I_D = -20.5 \text{ A}$		31		S
Diode Forward Voltage	V_{SD}	$I_S = -41 \text{ A}, V_{GS} = 0 \text{ V}$		-0.7		V
Dynamic^b						
Total Gate Charge	Q_g	$V_{DS} = -10 \text{ V}, V_{GS} = -4.5 \text{ V},$ $I_D = -21 \text{ A}$		30		nC
Gate-Source Charge	Q_{gs}			4		
Gate-Drain Charge	Q_{gd}			6		
Switching						
Turn-On Delay Time	$t_{d(on)}$	$V_{DD} = -10 \text{ V}, R_L = 15 \Omega, I_D = -41 \text{ A},$ $V_{GEN} = -10 \text{ V}, R_G = 6\Omega$		15		nS
Rise Time	t_r			12		
Turn-Off Delay Time	$t_{d(off)}$			62		
Fall-Time	t_f			46		

Notes

- Pulse test: $PW \leq 300\mu\text{s}$ duty cycle $\leq 2\%$.
- Guaranteed by design, not subject to production testing.

Analog Power (APL) reserves the right to make changes without further notice to any products herein. APL makes no warranty, representation or guarantee regarding the suitability of its products for any particular purpose, nor does APL assume any liability arising out of the application or use of any product or circuit, and specifically disclaims any and all liability, including without limitation special, consequential or incidental damages. "Typical" parameters which may be provided in APL data sheets and/or specifications can and do vary in different applications and actual performance may vary over time. All operating parameters, including "Typicals" must be validated for each customer application by customer's technical experts. APL does not convey any license under its patent rights nor the rights of others. APL products are not designed, intended, or authorized for use as components in systems intended for surgical implant into the body, or other applications intended to support or sustain life, or for any other application in which the failure of the APL product could create a situation where personal injury or death may occur. Should Buyer purchase or use APL products for any such unintended or unauthorized application, Buyer shall indemnify and hold APL and its officers, employees, subsidiaries, affiliates, and distributors harmless against all claims, costs, damages, and expenses, and reasonable attorney fees arising out of, directly or indirectly, any claim of personal injury or death associated with such unintended or unauthorized use, even if such claim alleges that APL was negligent regarding the design or manufacture of the part. APL is an Equal Opportunity/Affirmative Action Employer.

Package Information

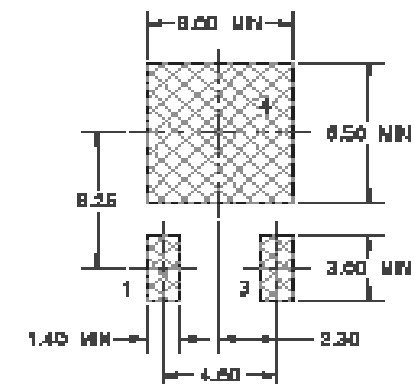
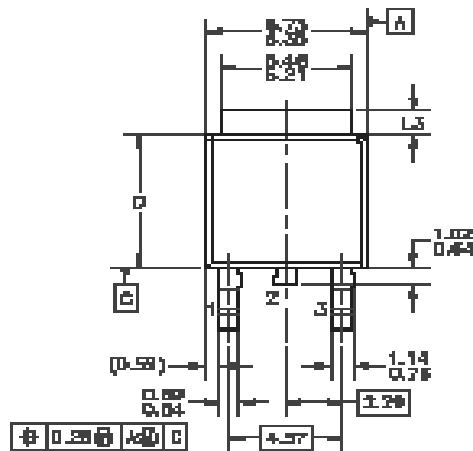

LAND PATTERN RECOMMENDATION

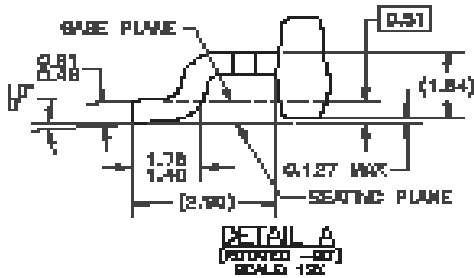
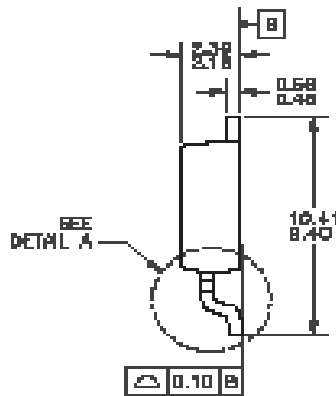
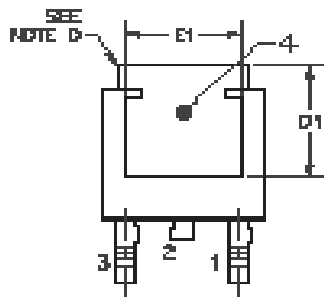

- NOTES: UNLESS OTHERWISE SPECIFIED
- A) ALL DIMENSIONS ARE IN MILLIMETERS.
 - B) THIS PACKAGE CONFORMS TO JEDEC, TO-262, ISSUE C, VARIATION AA, 30 DE, DATED NOV. 1999.
 - C) DIMENSIONING AND TOLERANCING PER ASME Y14.00M-1994.
 - D) HEAT SINK TOP EDGE COULD BE IN CHAMFERED CORNERS OR EDGE PROTRUSION.
 - E) DIMENSIONS L3,D,E1&D1 TABLE:

	OPTION A1	OPTION A2
L3	0.68-1.27	1.62-2.54
D	0.92-0.92	0.92-0.92
E1	4.32 MIN	3.81 MIN
D1	3.41 MIN	4.57 MIN