

N & P-Channel 100-V (D-S) MOSFET

Key Features:

- Low $r_{DS(on)}$ trench technology
- Low thermal impedance
- Fast switching speed

Typical Applications:

- White LED boost converters
- Automotive Systems
- Industrial DC/DC Conversion Circuits



RoHS
COMPLIANT
HALOGEN
FREE

DFN5x6-8L

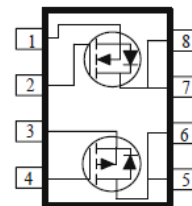

PRODUCT SUMMARY		
V_{DS} (V)	$r_{DS(on)}$ (m Ω)	I_D (A)
100	62 @ $V_{GS} = 10V$	4.8
	72 @ $V_{GS} = 5.5V$	4.4
-100	275 @ $V_{GS} = -10V$	-2.5
	295 @ $V_{GS} = -4.5V$	-2.4

ABSOLUTE MAXIMUM RATINGS ($T_A = 25^\circ\text{C}$ UNLESS OTHERWISE NOTED)

Parameter	Symbol	Nch Limit	Pch Limit	Units	
Drain-Source Voltage	V_{DS}	100	-100	V	
Gate-Source Voltage	V_{GS}	± 20	± 20		
Continuous Drain Current ^a	I_D	$T_A = 25^\circ\text{C}$	4.8	-2.5	A
		$T_A = 70^\circ\text{C}$	3.7	-2	
Pulsed Drain Current ^b	I_{DM}	20	-15		
Continuous Source Current (Diode Conduction) ^a	I_S	3	-2.7	A	
Power Dissipation ^a	P_D	$T_A = 25^\circ\text{C}$	2.1	2.1	W
		$T_A = 70^\circ\text{C}$	1.3	1.3	
Operating Junction and Storage Temperature Range	T_J, T_{stg}	-55 to 150		$^\circ\text{C}$	

THERMAL RESISTANCE RATINGS

Parameter	Symbol	Maximum	Units
Maximum Junction-to-Ambient ^a	$R_{\theta JA}$	62.5	$^\circ\text{C/W}$
		Steady State	

Notes

- Surface Mounted on 1" x 1" FR4 Board.
- Pulse width limited by maximum junction temperature

Electrical Characteristics

Parameter	Symbol	Test Conditions	Min	Typ	Max	Unit
Static						
Gate-Source Threshold Voltage	$V_{GS(th)}$	$V_{DS} = V_{GS}, I_D = 250 \mu A$ (N-ch)	1			V
		$V_{DS} = V_{GS}, I_D = -250 \mu A$ (P-ch)	-1			V
Gate-Body Leakage	I_{GSS}	$V_{DS} = 0 V, V_{GS} = \pm 20 V$			± 100	nA
Zero Gate Voltage Drain Current	I_{DSS}	$V_{DS} = 80 V, V_{GS} = 0 V$ (N-ch)			1	uA
		$V_{DS} = -80 V, V_{GS} = 0 V$ (P-ch)			-1	
On-State Drain Current	$I_{D(on)}$	$V_{DS} = 5 V, V_{GS} = 10 V$ (N-ch)	2.4			A
		$V_{DS} = -5 V, V_{GS} = -10 V$ (P-ch)	-1.2			A
Drain-Source On-Resistance	$r_{DS(on)}$	$V_{GS} = 10 V, I_D = 3.8 A$ (N-ch)			62	m Ω
		$V_{GS} = 4.5 V, I_D = 3.7 A$ (N-ch)			72	
		$V_{GS} = -10 V, I_D = -2 A$ (P-ch)			275	m Ω
		$V_{GS} = -4.5 V, I_D = -1.9 A$ (P-ch)			295	
Forward Transconductance	g_{fs}	$V_{DS} = 15 V, I_D = 3.8 A$ (N-ch)		22		S
		$V_{DS} = -15 V, I_D = -2.0 A$ (P-ch)		20		S
Diode Forward Voltage	V_{SD}	$I_S = 1.5 A, V_{GS} = 0 V$ (N-ch)		0.7		V
		$I_S = -1.3 A, V_{GS} = 0 V$ (P-ch)		0.8		V
Dynamic						
Total Gate Charge	Q_g	N - Channel $V_{DS} = 50 V, V_{GS} = 4.5 V, I_D = 3.8 A$		11		nC
Gate-Source Charge	Q_{gs}			3.6		
Gate-Drain Charge	Q_{gd}			6.1		
Total Gate Charge	Q_g	P - Channel $V_{DS} = -50 V, V_{GS} = 4.5 V, I_D = -2 A$		9		nC
Gate-Source Charge	Q_{gs}			3.7		
Gate-Drain Charge	Q_{gd}			4.0		
Turn-On Delay Time	$t_{d(on)}$	N - Channel $V_{DD} = 50 V, R_L = 13.2 \Omega, I_D = 3.8 A,$ $V_{GEN} = 10 V, R_{GEN} = 6 \Omega$		10		ns
Rise Time	t_r			12		
Turn-Off Delay Time	$t_{d(off)}$			53		
Fall Time	t_f			21		
Turn-On Delay Time	$t_{d(on)}$	P - Channel $V_{DD} = -50 V, R_L = 25 \Omega, I_D = -2 A,$ $V_{GEN} = -10 V, R_{GEN} = 6 \Omega$		6		ns
Rise Time	t_r			11		
Turn-Off Delay Time	$t_{d(off)}$			78		
Fall Time	t_f			51		
Input Capacitance	C_{iss}	N - Channel $V_{DS} = 15 V, V_{GS} = 0 V, f = 1 MHz$		1122		pF
Output Capacitance	C_{oss}			130		
Reverse Transfer Capacitance	C_{rss}			82		
Input Capacitance	C_{iss}	P - Channel $V_{DS} = -15 V, V_{GS} = 0 V, f = 1 MHz$		1222		pF
Output Capacitance	C_{oss}			128		
Reverse Transfer Capacitance	C_{rss}			63		

Typical Electrical Characteristics - N-channel

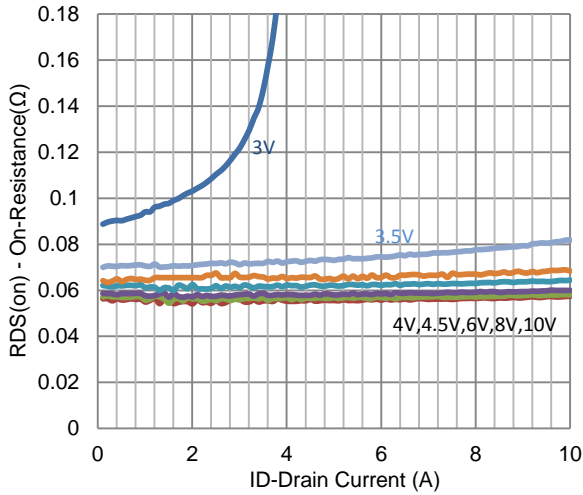

1. On-Resistance vs. Drain Current

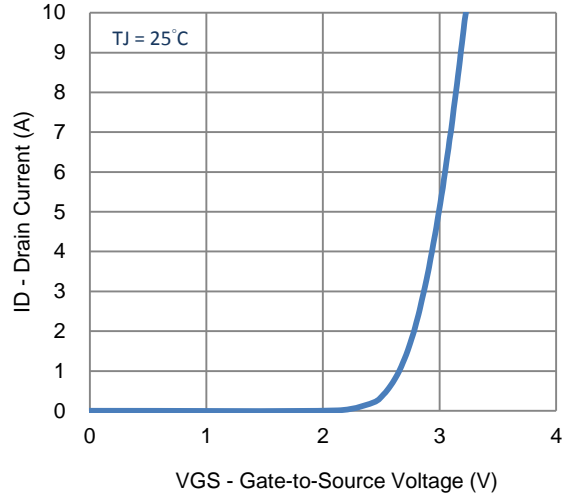

2. Transfer Characteristics

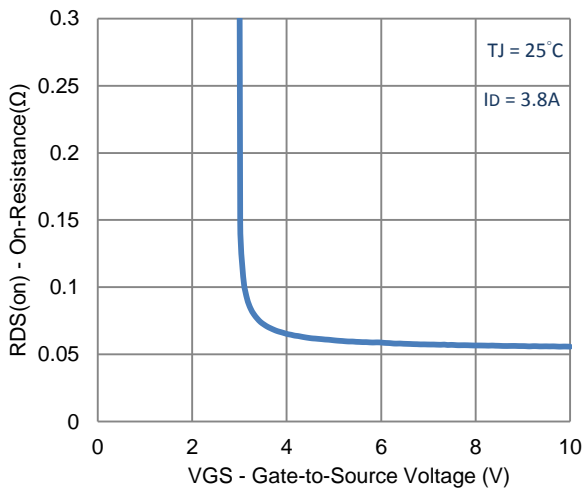

3. On-Resistance vs. Gate-to-Source Voltage

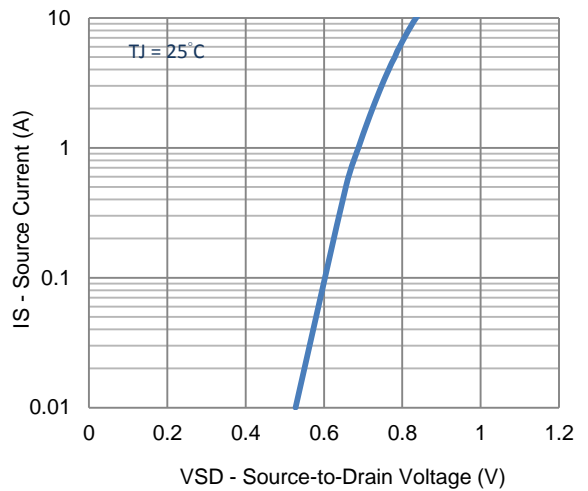

4. Drain-to-Source Forward Voltage

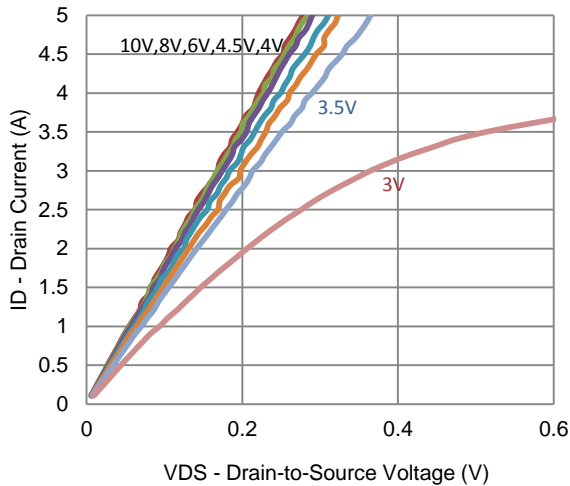

5. Output Characteristics

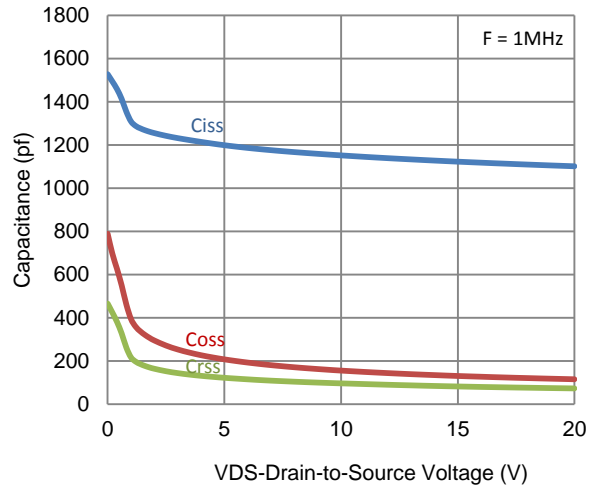

6. Capacitance

Typical Electrical Characteristics - N-channel

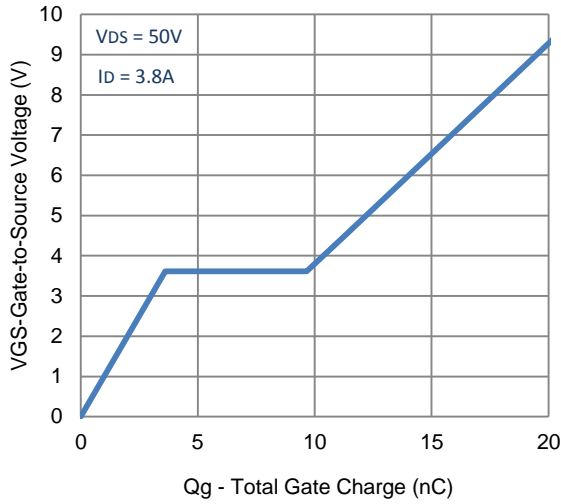

7. Gate Charge

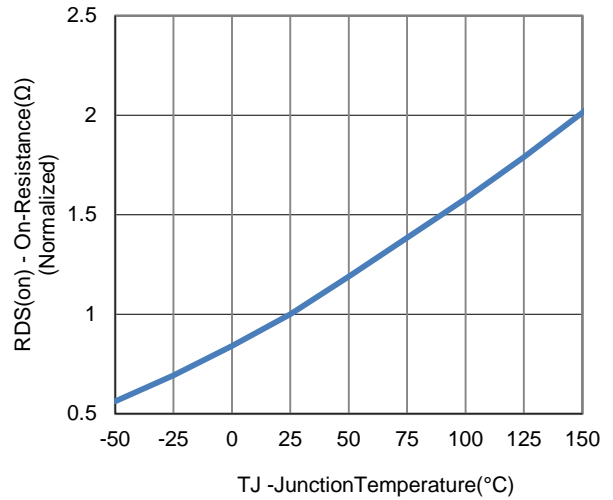

8. Normalized On-Resistance Vs Junction Temperature

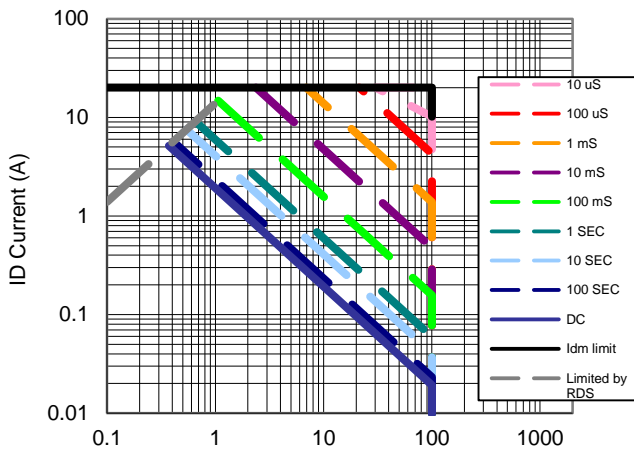

9. Safe Operating Area

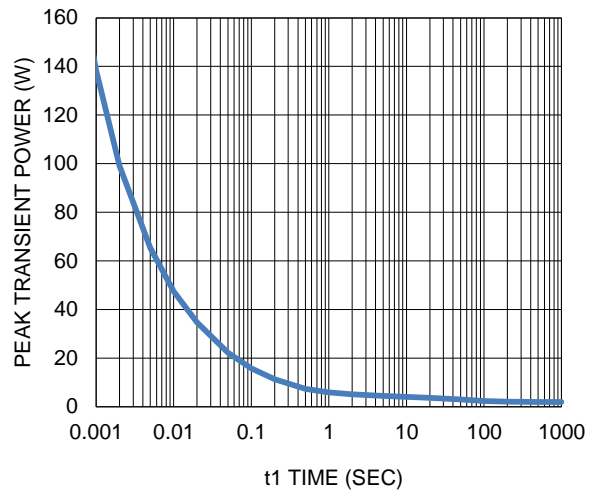

10. Single Pulse Maximum Power Dissipation

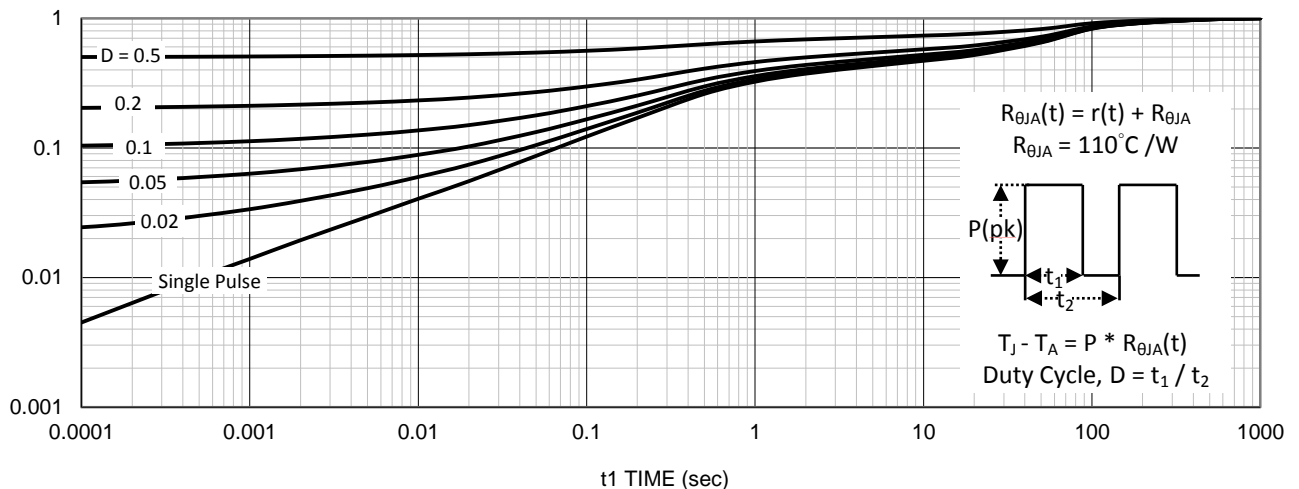

11. Normalized Thermal Transient Junction to Ambient

Typical Electrical Characteristics - P-channel

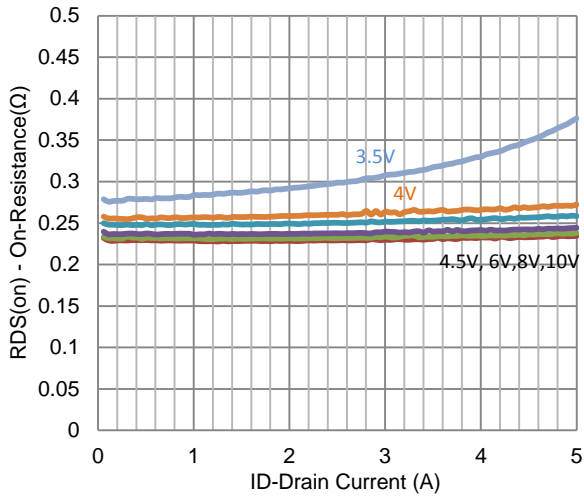

1. On-Resistance vs. Drain Current

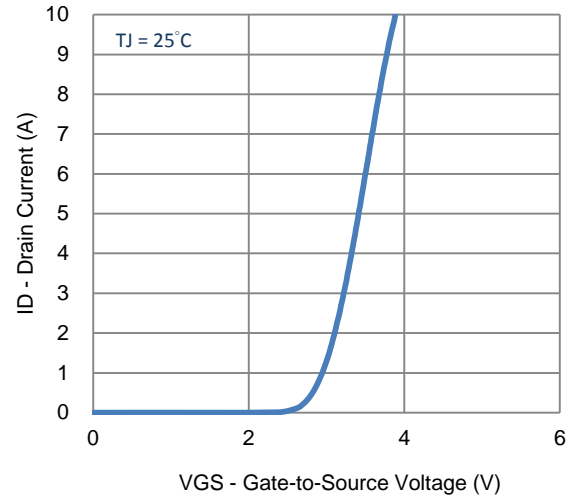

2. Transfer Characteristics

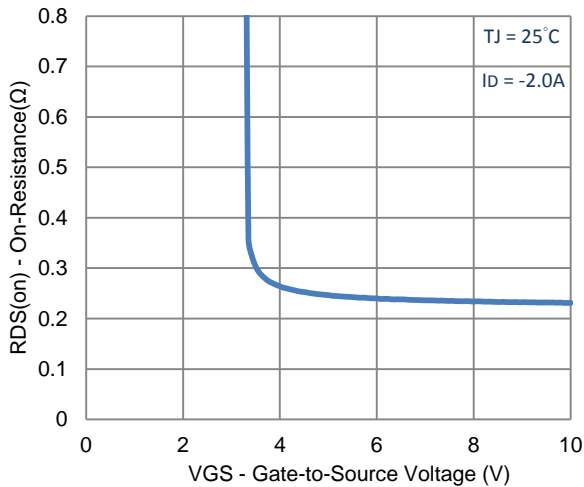

3. On-Resistance vs. Gate-to-Source Voltage

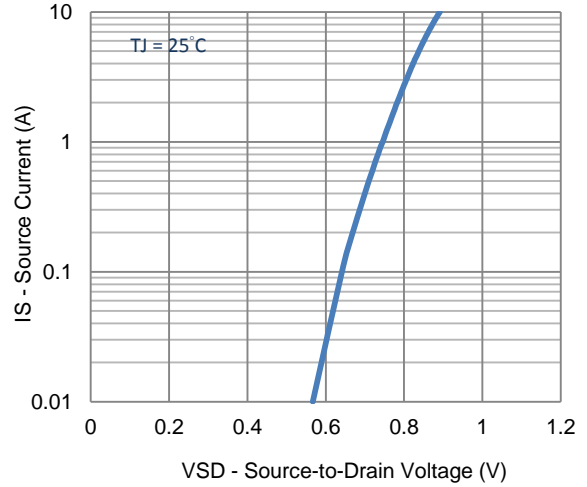

4. Drain-to-Source Forward Voltage

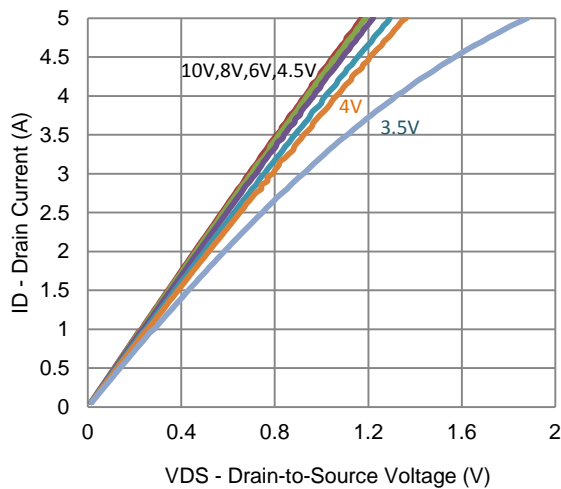

5. Output Characteristics

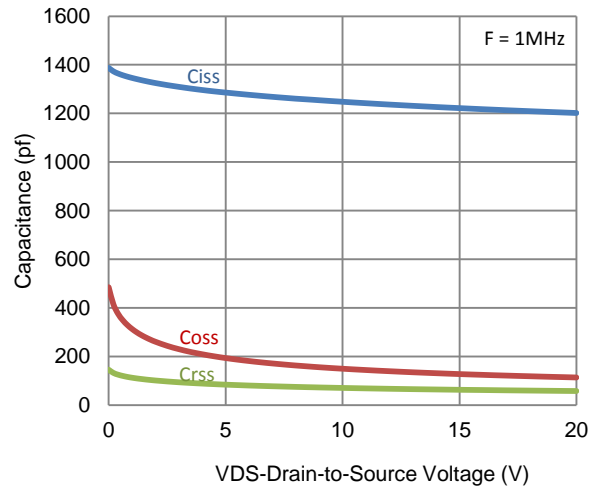

6. Capacitance

Typical Electrical Characteristics - P-channel

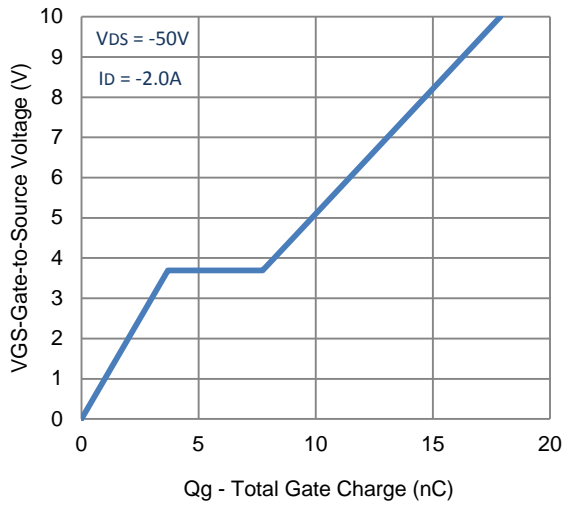

7. Gate Charge

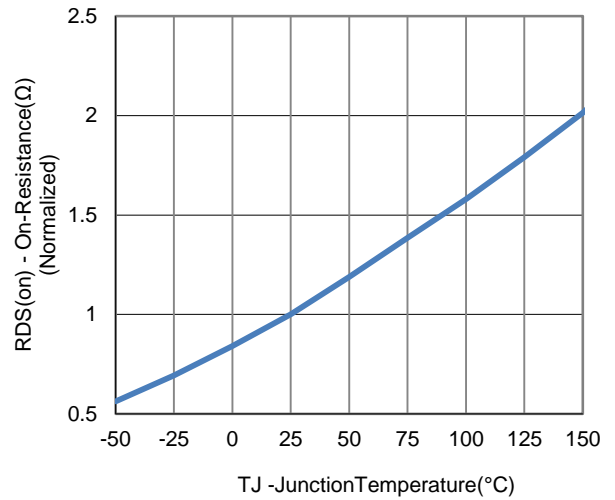

8. Normalized On-Resistance Vs Junction Temperature

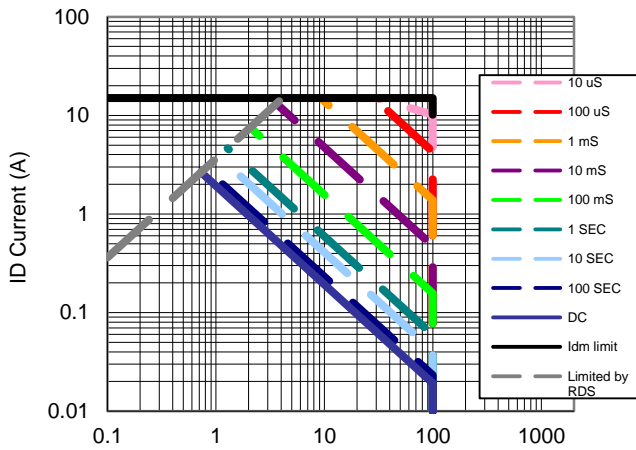

9. Safe Operating Area

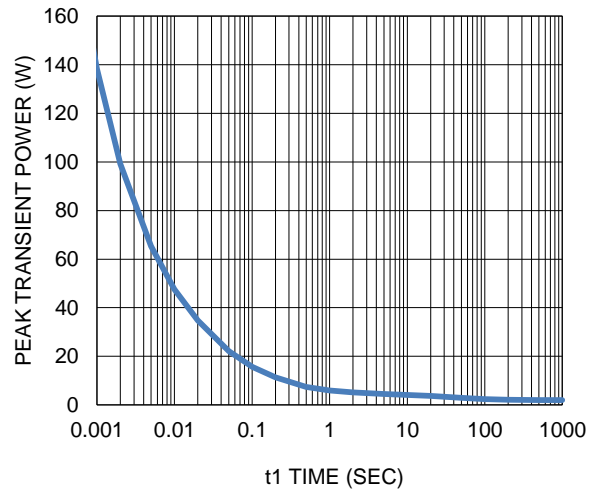

10. Single Pulse Maximum Power Dissipation

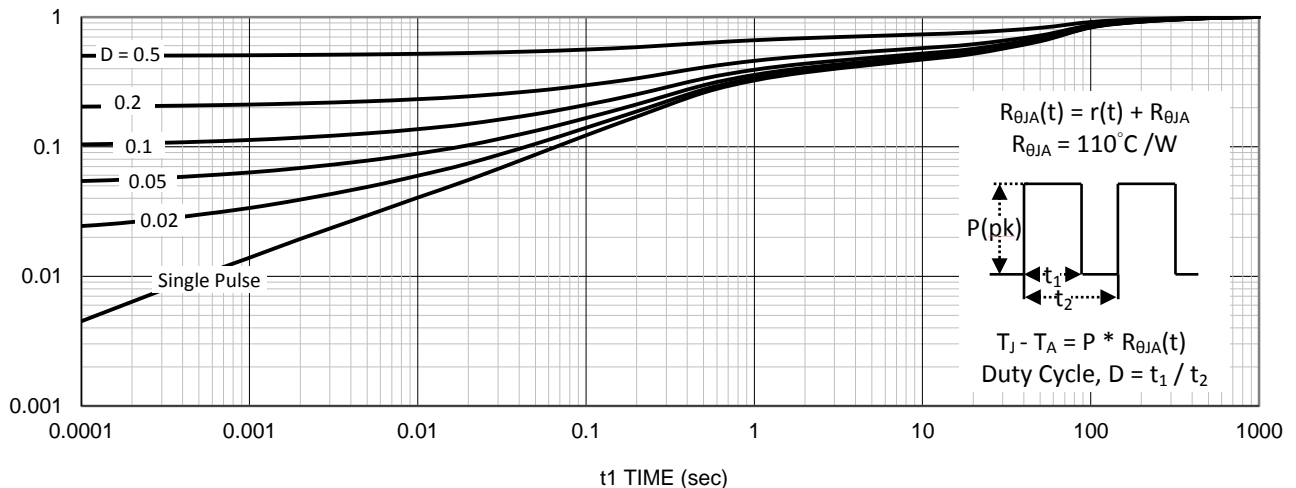

11. Normalized Thermal Transient Junction to Ambient

Package Information

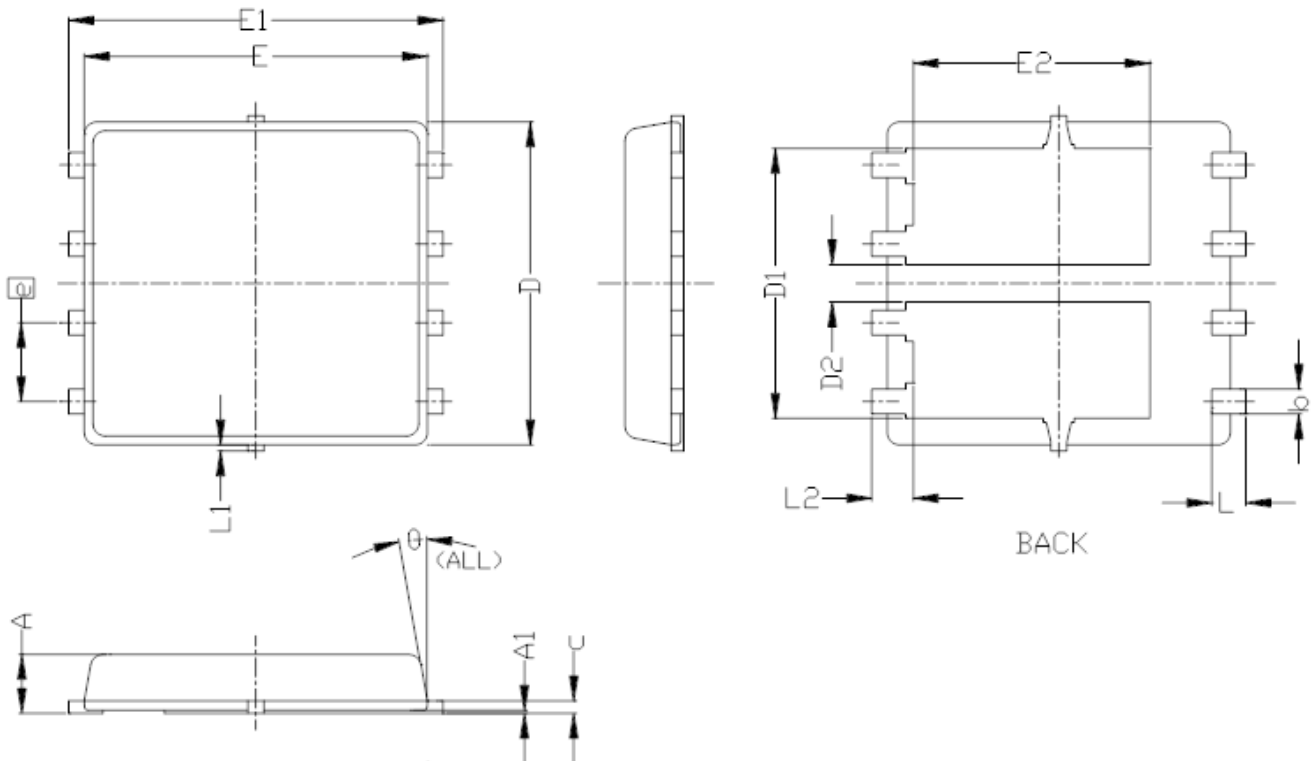

SYMBOLS	DIMENSIONS IN MILLIMETERS			DIMENSIONS IN INCHES		
	MIN	NOM	MAX	MIN	NOM	MAX
A	0.85	0.95	1.00	0.033	0.037	0.039
A1	0.00	---	0.05	0.000	---	0.002
b	0.30	0.40	0.50	0.012	0.016	0.020
c	0.15	0.20	0.25	0.006	0.008	0.010
D	5.20 BSC			0.205 BSC		
D1	4.35 BSC			0.171 BSC		
D2	0.50	0.60	0.75	0.020	0.024	0.030
E	5.55 BSC			0.219 BSC		
E1	6.05 BSC			0.238 BSC		
E2	3.82 BSC			0.150 BSC		
e	1.27 BSC			0.050 BSC		
L	0.45	0.55	0.65	0.018	0.022	0.026
L1	0	---	0.15	0	---	0.006
L2	0.68 REF			0.027 REF		
θ	0°	---	10°	0°	---	10°