

# Am78/8831·Am78/8832

## Three-State Line Driver

### Distinctive Characteristics

- Three-State Line Drivers pin-for-pin equivalent to the DM78/8831 and DM78/8832
- Mode control for quad single-ended or dual differential operation
- Common bus operation
- High-drive capability
- 40mA sink and source current
- Series 54/74 compatible
- 13ns typical propagation delay
- 100% reliability assurance testing in compliance with MIL-STD-883

### FUNCTIONAL DESCRIPTION

The Am78/8831 and Am78/8832 line drivers can be used either as a quad single-ended driver or as a dual differential driver. Each driver has a three-state output making the device particularly suitable for party-line operation where several drivers are directly connected to the same bus. The Am78/8832 does not have the VCC clamp diodes found on the Am74/8831.

When used for single-ended operation the two differential/single-ended control inputs are held LOW. The device then operates as four independent non-inverting drivers. For differential working at least one differential/single-ended control input is held HIGH. The A-channel inputs are connected together and the B-channel inputs are connected together. Signal inputs will then pass non-inverted to the A<sub>2</sub> and B<sub>2</sub> outputs and inverted on the A<sub>1</sub> and B<sub>1</sub> outputs.

For party-line operation outputs of different channels are tied together, and outputs of all channels except one are forced into the third high impedance state by having at least one of the channel disable inputs HIGH. The channel that is enabled has both channel disable inputs LOW, and the low-output impedance of this output at both logic levels controls the level of the bus, provides good capacitance drive and insures good waveform integrity.

The channel which is enabled can conveniently be selected by a decoding matrix using Am9301 1-of-10 or Am9311 1-of-16 active LOW output decoders. The high drive capability at both logic levels enables drivers to drive a low impedance line and still supply the inverse leakage current of several disabled drivers.

### LOGIC SYMBOL

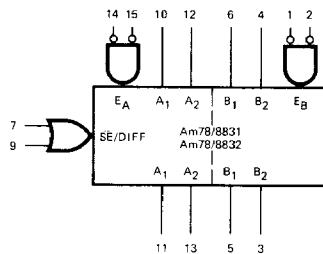

V<sub>CC</sub> = Pin 16  
GND = Pin 8

LIC-532

### LOGIC DIAGRAM

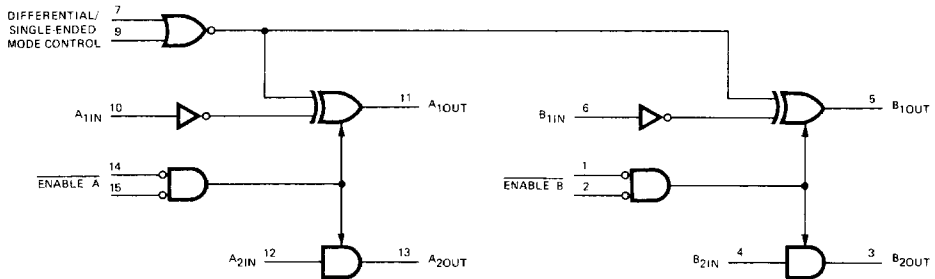

LIC-533

### ORDERING INFORMATION

Package Type	Temperature Range	Am78/8831 Order Number	Am78/8832 Order Number
Molded DIP	0°C to +75°C	DM8831N	DM8832N
Hermetic DIP	0°C to +75°C	DM8831J	DM8832J
Dice	0°C to +75°C	AM8831X	AM8832X
Hermetic DIP	-55°C to +125°C	DM7831J	DM7832J
Hermetic Flat Pak	-55°C to +125°C	DM7831W	DM7832W
Dice	-55°C to +125°C	AM7831X	AM8832X

### CONNECTION DIAGRAM Top View

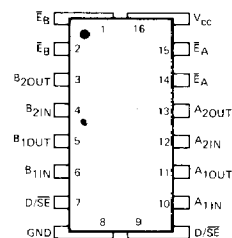

Note: Pin 1 is marked for orientation.

LIC-534

**Am78/8831 • Am78/8832**
**MAXIMUM RATINGS** (Above which the useful life may be impaired)

Storage Temperature	-65°C to +150°C
Temperature (Ambient) Under Bias	-55°C to +125°C
Supply Voltage to Ground Potential (Pin 16 to Pin 8) Continuous	-0.5 V to +7 V
DC Voltage Applied to Outputs for HIGH Output State	-0.5 V to +V <sub>CC</sub> max
DC Input Voltage	-0.5 V to +5.5 V
Output Current, Into Outputs	30 mA
DC Input Current	-30 mA to +5.0 mA
Time that 2 Bus-Connected Devices May Be in Opposite Low Impedance States Simultaneously	∞

**ELECTRICAL CHARACTERISTICS OVER OPERATING TEMPERATURE RANGE** (Unless Otherwise Noted)

Am8831, Am8832	T <sub>A</sub> = 0°C to +75°C	V <sub>CC</sub> = 5.0V ±5% (COM'L)	MIN. = 4.75V	MAX. = 5.25V
Am7831, Am7832	T <sub>A</sub> = -55°C to +125°C	V <sub>CC</sub> = 5.0V ±10% (MIL)	MIN. = 4.5V	MAX. = 5.5V

Parameters	Description	Test Conditions	Typ. (Note 1)		Max.	Units	
			Min.	Max.			
V <sub>OH</sub>	Output HIGH Voltage	V <sub>CC</sub> = MIN., V <sub>IN</sub> = V <sub>IH</sub> or V <sub>IL</sub>	I <sub>OH</sub> = -40 mA	1.8	2.8	Volts	
			Am7831, 32 I <sub>OH</sub> = -2 mA Am8831, 32 I <sub>OH</sub> = -5.2 mA	2.4	3.1		
V <sub>OL</sub>	Output LOW Voltage	V <sub>CC</sub> = MIN., V <sub>IN</sub> = V <sub>IH</sub> or V <sub>IL</sub>	I <sub>OL</sub> = 40 mA		0.29	0.5	Volts
			I <sub>OL</sub> = 32 mA		0.2	0.4	
V <sub>IH</sub>	Input HIGH Level Voltage	Guaranteed input logical HIGH voltage for all inputs	2.0			Volts	
V <sub>IL</sub>	Input LOW Level Voltage	Guaranteed input logical LOW voltage for all inputs			0.8	Volts	
I <sub>L</sub>	Unit Load Input LOW Current	V <sub>CC</sub> = MAX., V <sub>IN</sub> = 0.4 V			-1.0	-1.6	mA
					6.0	40	
I <sub>IH</sub>	Unit Load Input HIGH Current	V <sub>CC</sub> = MAX., V <sub>IN</sub> = 2.4 V			1.0		mA
I <sub>LK</sub>	Output Leakage Current	V <sub>CC</sub> = MAX., V <sub>IN</sub> = 5.5 V					μA
		V <sub>CC</sub> = MAX., $\bar{E}$ = 2.4 V, V <sub>OUT</sub> = 2.4 V		5	40		
V <sub>I</sub>	Input Clamp Diode Voltage	V <sub>CC</sub> = MAX., $\bar{E}$ = 2.4 V, V <sub>OUT</sub> = 0.4 V					Volts
		V <sub>CC</sub> = 5.0 V, I <sub>I</sub> = -12 mA, T <sub>A</sub> = 25°C				-1.5	
V <sub>O</sub>	Output Clamp Diode Voltage	V <sub>CC</sub> = 5.0 V, I <sub>I</sub> = 12 mA, T <sub>A</sub> = 25°C Am78/8831 Only				V <sub>CC</sub> + 1.5V	Volts
V <sub>O</sub>	Output Substrate Diode Voltage	V <sub>CC</sub> = 5.0 V, I <sub>I</sub> = -12 mA, T <sub>A</sub> = 25°C				-1.5	Volts
I <sub>SC</sub> (Note 2)	Output Short Circuit Current	V <sub>CC</sub> = MAX., V <sub>OUT</sub> = 0.0 V, T <sub>A</sub> = MAX.	-40			-120	mA
I <sub>CC</sub>	Power Supply Current	V <sub>CC</sub> = MAX.		57		90	mA

Notes: 1. Typical limits are at V<sub>CC</sub> = 5.0 V, 25°C ambient and maximum loading.  
2. Only one output should be shorted at a time.

**SWITCHING CHARACTERISTICS** (T<sub>A</sub> = 25°C)

Parameters	Description	Min.	Typ.	Max.	Units
t <sub>PLH</sub>	Delay from Inputs A1, A2, B1, B2 and Single-Ended/ Diff. Control to Output		13	25	ns
t <sub>PHL</sub>			13	25	ns
t <sub>HZ</sub>	Delay from Output Enable to Output		6	12	ns
t <sub>LZ</sub>			14	22	ns
t <sub>ZH</sub>	Delay from Output Enable to Output		14	22	ns
t <sub>ZL</sub>			18	27	ns

TYPICAL PERFORMANCE CHARACTERISTICS

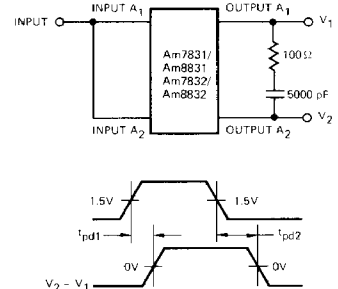
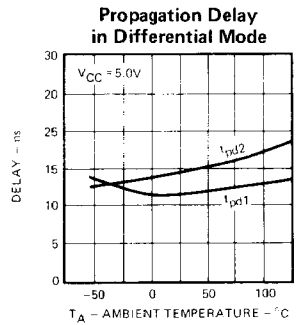
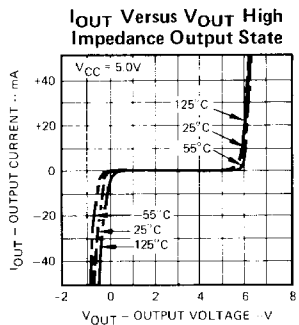
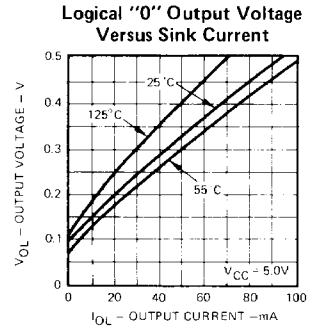
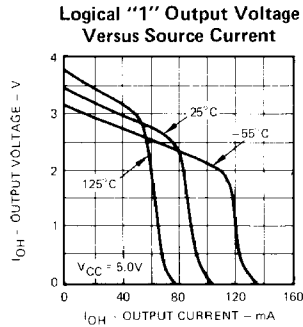
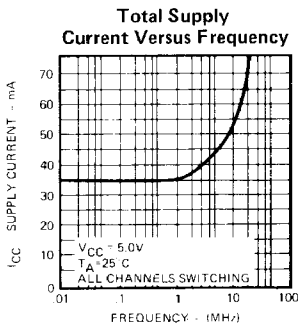
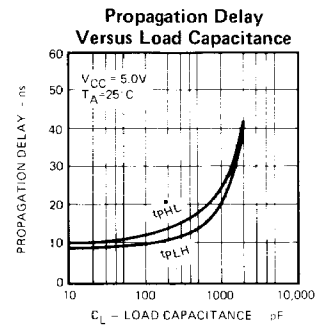
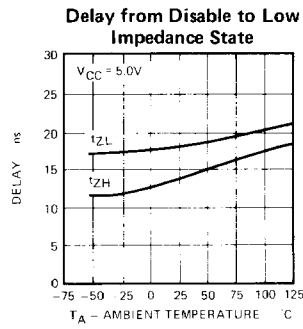
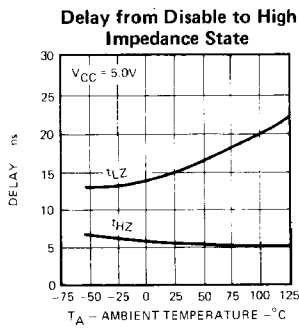
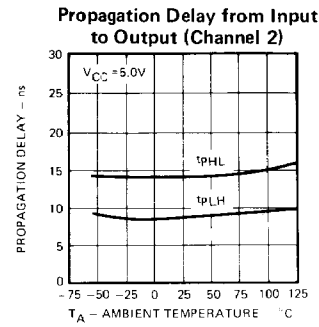
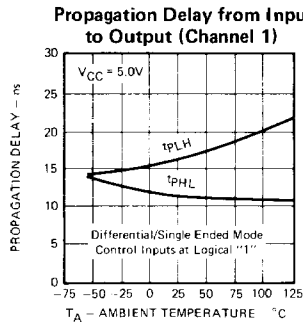
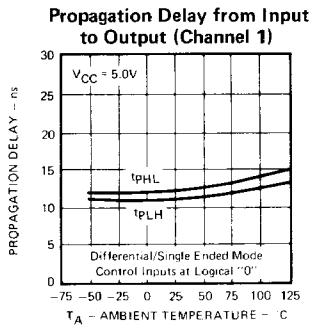

### SWITCHING TIME WAVEFORMS AND TEST CIRCUIT

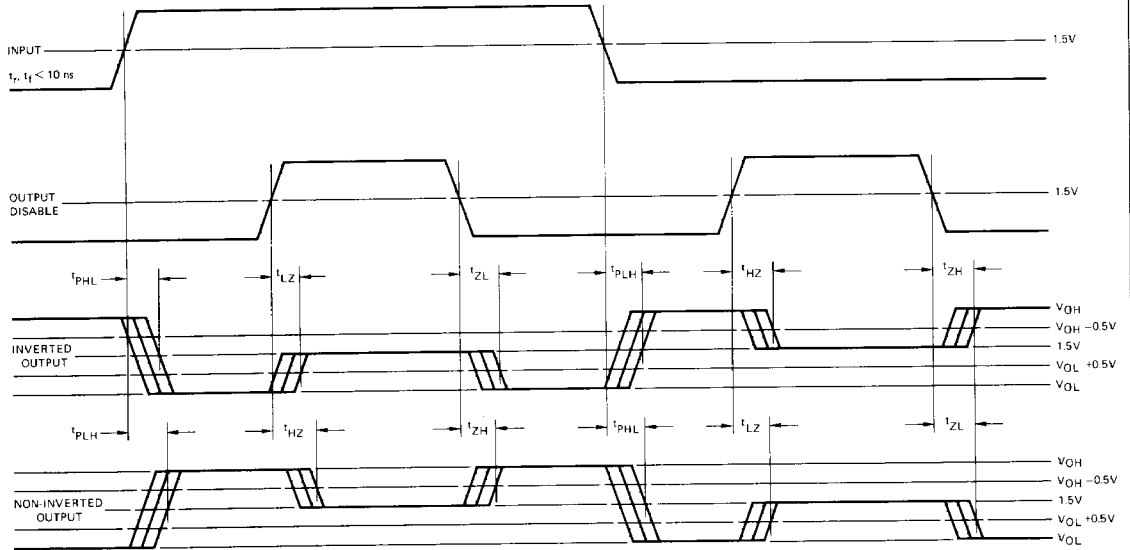

NOTE:  $V_{OL}$  and  $V_{OH}$  refer to actual voltages on output LOW and HIGH states.

#### KEY TO TIMING DIAGRAM

WAVEFORM	INPUTS	OUTPUTS	WAVEFORM	INPUTS	OUTPUTS
	MUST BE STEADY	MUST BE STEADY		DON'T CARE ANY CHANGE PERMITTED	CHANGING STATE PERMITTED
	MAY CHANGE FROM 0 TO 1	DON'T CARE ANY CHANGE PERMITTED		DON'T CARE ANY CHANGE PERMITTED	DON'T CARE ANY CHANGE PERMITTED
	MAY CHANGE FROM 1 TO 0	DON'T CARE ANY CHANGE PERMITTED		DON'T CARE ANY CHANGE PERMITTED	CHANGING STATE PERMITTED

LIC-536

#### LOAD CIRCUIT

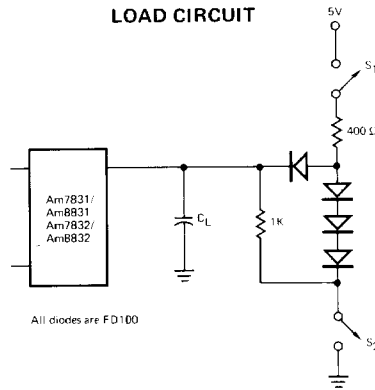

All diodes are FD100

	Switch $S_1$	Switch $S_2$	$C_L$
$t_{PLH}$	closed	closed	50 pF
$t_{PHL}$	closed	closed	50 pF
$t_{HZ}$	closed	closed	* 5 pF
$t_{LZ}$	closed	closed	* 5 pF
$t_{ZL}$	closed	open	50 pF
$t_{ZH}$	open	closed	50 pF

\* Jig Capacitance

LIC-537

**TRUTH TABLE**  
(Shown for A Channels Only)

SINGLE-ENDED/ DIFF CONTROL			A ENABLE		IN A <sub>1</sub>	OUT A <sub>1</sub>	IN A <sub>2</sub>	OUT A <sub>2</sub>
L	L	L	L	L	A <sub>1</sub>	A <sub>1</sub>	A <sub>2</sub>	A <sub>2</sub>
H	X	L	L	A <sub>1</sub>	$\bar{A}_1$	A <sub>2</sub>	A <sub>2</sub>	
X	H	L	L	A <sub>1</sub>	$\bar{A}_1$	A <sub>2</sub>	A <sub>2</sub>	
X	X	H	X	X	F	X	F	
X	X	X	H	X	F	X	F	

H = HIGH Voltage Level  
X = Don't Care  
L = LOW Voltage Level  
F = Floating Output

TABLE I

**MSI INTERFACING RULES**

Interfacing Digital Family	Equivalent Input Unit Load	
	HIGH	LOW
Advanced Micro Devices 54/7400	1	1
Advanced Micro Devices 9300/2500 Series	1	1
FSC Series 9300	1	1
T1 Series 54/7400	1	1
Signetics Series 8200	2	2
National Series DM 75/85	1	1
DTL Series 930	12	1

TABLE III

**LOADING RULES (In Unit Loads)**

Input/Output	Pin No.'s	Input Unit Load	Output HIGH	Fan-out Output LOW
Enable B	1	1	—	—
Enable $\bar{B}$	2	1	—	—
B <sub>2</sub> Out	3	—	1000	25
B <sub>2</sub> In	4	1	—	—
B <sub>1</sub> Out	5	—	1000	25
B <sub>1</sub> In	6	1	—	—
$\bar{S}\bar{E}$ /Diff	7	1	—	—
GND	8	—	—	—
$\bar{S}\bar{E}$ /Diff	9	1	—	—
A <sub>1</sub> In	10	1	—	—
A <sub>1</sub> Out	11	—	1000	25
A <sub>2</sub> In	12	1	—	—
A <sub>2</sub> Out	13	—	1000	25
Enable A	14	1	—	—
Enable $\bar{A}$	15	1	—	—
VCC	16	—	—	—

TABLE II

**INPUT/OUTPUT INTERFACE CONDITIONS**

**Voltage Interface Conditions – LOW & HIGH**

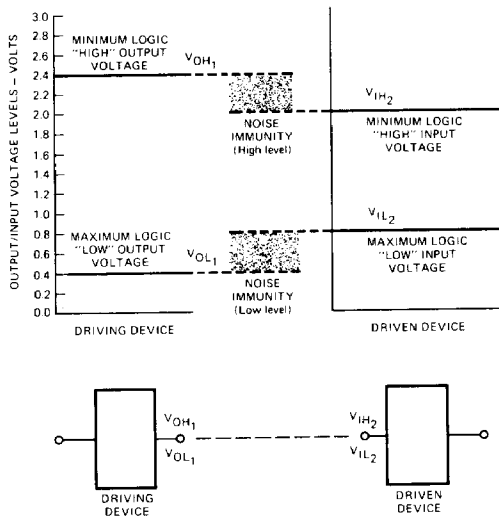

**Current Interface Conditions – LOW**

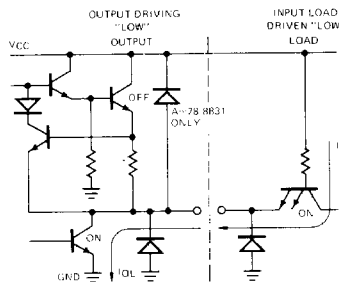

**Current Interface Conditions – FLOATING**

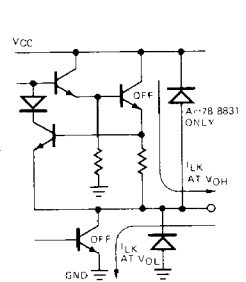

**Current Interface Conditions – HIGH**

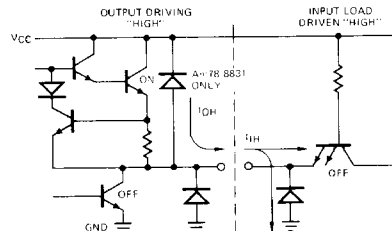

LIC-538

APPLICATIONS

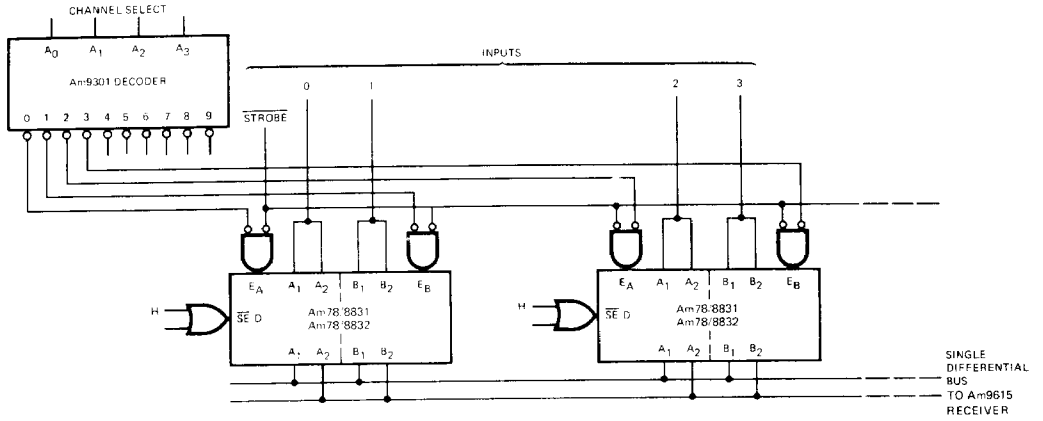

LIC-539

PARTY LINE DIFFERENTIAL OPERATION

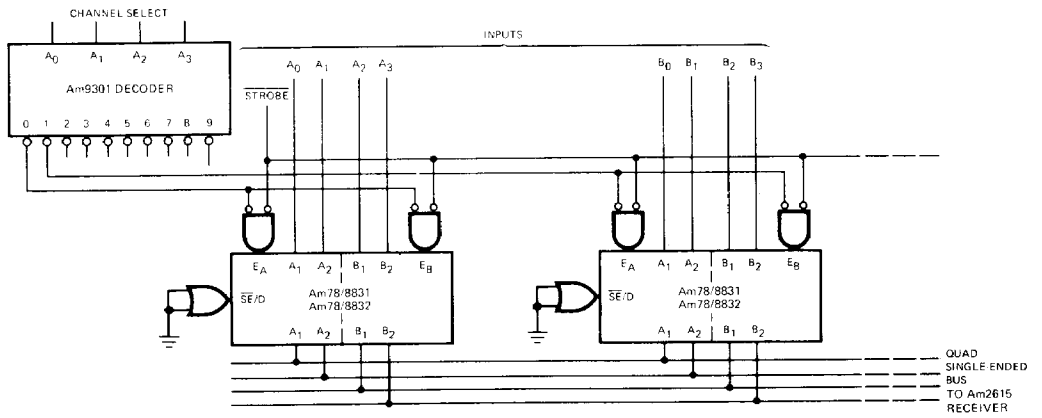

LIC-540

PARTY LINE SINGLE-ENDED OPERATION

Metallization and Pad Layout

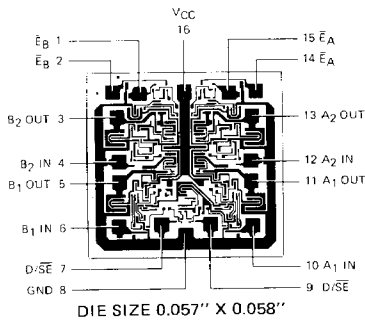

DIE SIZE 0.057" X 0.058"