

# Am9101/Am91L01/Am2101 FAMILY

256x4 Static R/W Random Access Memories

2

PART NUMBER	Am2101	Am2101-2	Am9101A Am91L01A Am2101-1	Am9101B Am91L01B	Am9101C Am91L01C	Am9101D
ACCESS TIME	1000ns	650ns	500ns	400ns	300ns	250ns

### DISTINCTIVE CHARACTERISTICS

- 256 x 4 organization
- Low operating power  
125mW Typ; 290mW maximum — standard power  
100mW Typ; 175mW maximum — low power
- DC standby mode reduces power up to 84%
- Logic voltage levels identical to TTL
- High output drive — two full TTL loads
- High noise immunity — full 400mV
- Single 5 volt power supply —  
tolerances: ±5% commercial, ±10% military
- Uniform switching characteristics — access times insensitive to supply variations, addressing patterns and data patterns
- Both military and commercial temperature ranges available
- Two chip enable inputs
- Output disable control
- Zero address set-up and hold times for simplified timing
- 100% MIL-STD-883 reliability assurance testing

### FUNCTIONAL DESCRIPTION

The Am9101/Am91L01 series of devices are high-performance, low-power, 1024-bit, static, read/write random access memories. They offer a wide range of access times including versions as fast as 200ns. Each memory is implemented as 256 words by 4 bits per word. This organization permits efficient design of small memory systems and allows finer resolution of incremental memory depth.

These memories may be operated in a DC standby mode for reductions of as much as 84 percent of the normal power dissipation. Data can be retained with a power supply as low as 1.5 volts. The low power Am91L01 series offer reduced power dissipation during normal operating conditions and even lower dissipation in the standby mode.

The Chip Enable input control signals act as high order address lines and they control the write amplifier and the output buffers. The Output Disable signal provides independent control over the output state of enabled chips.

These devices are all fully static and no refresh operations or sense amplifiers or clocks are required. Input and output signal levels are identical to TTL specifications, providing simplified interfacing and high noise immunity. The outputs will drive two full TTL loads for increased fan-out and better bus interfacing capability.

### Am9101 BLOCK DIAGRAM

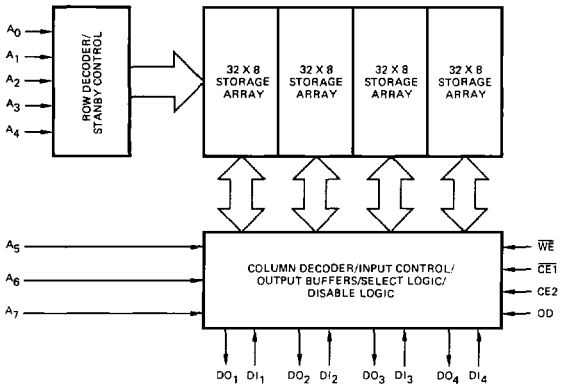

MOS-343

### CONNECTION DIAGRAM Top View

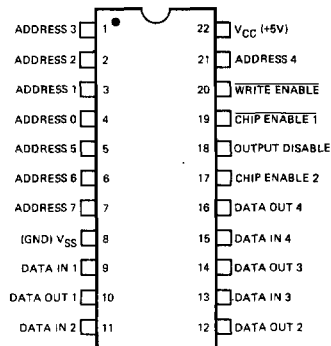

Note: Flat Pack version available in 24-pin package.

MOS-344

### ORDERING INFORMATION

Ambient Temperature Specification	Package Type	Power Type	Access Times					
			1000ns	650ns	500ns	400ns	300ns	250ns
0°C to +70°C	Molded DIP	Standard	P2101	P2101-2	P2101-1 AM9101APC	AM9101BPC	AM9101CPC	AM9101DPC
		Low			AM91L01APC	AM91L01BPC	AM91L01CPC	
	Hermetic DIP	Standard	C2101	C2101-2	C2101-1 AM9101ADC	AM9101BDC	AM9101CDC	AM9101DDC
		Low			AM91L01ADC	AM91L01BDC	AM91L01CDC	
-55°C to +125°C	Hermetic DIP	Standard			AM9101ADM	AM9101BDM	AM9101CDM	
		Low			AM91L01ADM	AM91L01BDM	AM91L01CDM	
	Hermetic Flat Pack	Standard			AM9101AFM	AM9101BFM		
		Low			AM91L01AFM	AM91L01BFM		

## Am9101/Am91L01/Am2101 Family

**MAXIMUM RATINGS** above which the useful life may be impaired

Storage Temperature	-65°C to +150°C
Ambient Temperature Under Bias	-55°C to +125°C
V <sub>CC</sub> With Respect to V <sub>SS</sub> , Continuous	-0.5V to +7.0V
DC Voltage Applied to Outputs	-0.5V to +7.0V
DC Input Voltage	-0.5V to +7.0V
Power Dissipation	1.0W

### ELECTRICAL CHARACTERISTICS

Am9101PC, Am9101DC      T<sub>A</sub> = 0°C to +70°C  
 Am91L01PC Am91L01DC      V<sub>CC</sub> = +5.0V ±5%  
 Am2101

Am9101/  
Am91L01  
Family      Am2101  
Family

Parameters	Description	Test Conditions	Am9101/ Am91L01 Family		Am2101 Family		Units
			Min.	Max.	Min.	Max.	
V <sub>OH</sub>	Output HIGH Voltage	V <sub>CC</sub> = MIN.	I <sub>OH</sub> = -200μA	2.4			Volts
			I <sub>OH</sub> = -150μA			2.2	
V <sub>OL</sub>	Output LOW Voltage	V <sub>CC</sub> = MIN.	I <sub>OL</sub> = 3.2mA		0.4		Volts
			I <sub>OL</sub> = 2.0mA			0.45	
V <sub>IH</sub>	Input HIGH Voltage		2.0	V <sub>CC</sub>	2.2	V <sub>CC</sub>	Volts
V <sub>IL</sub>	Input LOW Voltage		-0.5	0.8	-0.5	0.65	Volts
I <sub>LI</sub>	Input Load Current	V <sub>CC</sub> = MAX., 0V < V <sub>IN</sub> < 5.25V		10		10	μA
I <sub>LO</sub>	Output Leakage Current	V <sub>CE</sub> = V <sub>IH</sub>	V <sub>OUT</sub> = V <sub>CC</sub>	5.0		15	μA
			V <sub>OUT</sub> = 0.4V	-10		-50	
I <sub>CC1</sub>	Power Supply Current	Data out open V <sub>CC</sub> = Max. V <sub>IN</sub> = V <sub>CC</sub>	T <sub>A</sub> = 25°C	Am9101A/B	50	60	mA
				Am9101C/D/E	55		
				Am91L01A/B	31		
				Am91L01C	34		
I <sub>CC2</sub>	Power Supply Current	Data out open V <sub>CC</sub> = Max. V <sub>IN</sub> = V <sub>CC</sub>	T <sub>A</sub> = 0°C	Am9101A/B	55	70	mA
				Am9101C/D/E	60		
				Am91L01A/B	33		
				Am91L01C	36		

### ELECTRICAL CHARACTERISTICS

Am9101DM, Am9101FM      T<sub>A</sub> = -55°C to +125°C  
 Am91L01DM, Am91L01FM      V<sub>CC</sub> = +5.0V ±10%

Am9101/  
Am91L01  
Family

Parameters	Description	Test Conditions	Am9101/ Am91L01 Family		Units	
			Min.	Max.		
V <sub>OH</sub>	Output HIGH Voltage	I <sub>OH</sub> = -200μA	V <sub>CC</sub> = 4.75V	2.4	Volts	
			V <sub>CC</sub> = 4.5V	2.2		
V <sub>OL</sub>	Output LOW Voltage	V <sub>CC</sub> = MIN., I <sub>OL</sub> = 3.2mA		0.4	Volts	
V <sub>IH</sub>	Input HIGH Voltage		2.0	V <sub>CC</sub>	Volts	
V <sub>IL</sub>	Input LOW Voltage		-0.5	0.8	Volts	
I <sub>LI</sub>	Input Load Current	V <sub>CC</sub> = MAX., 0V < V <sub>IN</sub> < 5.5V		10	μA	
I <sub>LO</sub>	Output Leakage Current	V <sub>CE</sub> = V <sub>IH</sub>	V <sub>OUT</sub> = V <sub>CC</sub>	10	μA	
			V <sub>OUT</sub> = 0.4V	-10		
I <sub>CC1</sub>	Power Supply Current	Data out open V <sub>CC</sub> = Max. V <sub>IN</sub> = V <sub>CC</sub>	T <sub>A</sub> = 25°C	Am9101A/B	50	mA
				Am9101C	55	
				Am91L01A/B	31	
				Am91L01C	34	
I <sub>CC3</sub>	Power Supply Current	Data out open V <sub>CC</sub> = Max. V <sub>IN</sub> = V <sub>CC</sub>	T <sub>A</sub> = -55°C	Am9101A/B	60	mA
				Am9101C	65	
				Am91L01A/B	37	
				Am91L01C	40	

### CAPACITANCE

Parameters	Description	Test Conditions	Typ.	Max.	Units	
C <sub>IN</sub>	Input Capacitance, V <sub>IN</sub> = 0V	T <sub>A</sub> = 25°C, f = 1MHz	Am2101	4.0	8.0	pF
			Am9101/Am91L01	3.0	6.0	
C <sub>OUT</sub>	Output Capacitance, V <sub>OUT</sub> = 0V		Am2101	8.0	12	pF
			Am9101/Am91L01	6.0	9.0	

**SWITCHING CHARACTERISTICS** over operating temperature and voltage range

Output Load = 1 TTL Gate + 100pF

$T_A = 0$  to  $70^\circ\text{C}$

$V_{CC} = +5V \pm 5\%$

Transition Times = 10ns

$T_A = -55$  to  $+125^\circ\text{C}$

$V_{CC} = +5V \pm 10\%$

Input Levels, Output References = 0.8V and 2.0V

Parameters	Description	2101		2101-2		2101-1		9101A 91L01A		9101B 91L01B		9101C 91L01C		9101D		Units
		Min	Max	Min	Max	Min	Max	Min	Max	Min	Max	Min	Max	Min	Max	
$t_{RC}$	Read Cycle Time	1000		650		500		500		400		300		250		ns
$t_A$	Access Time		1000		650		500		500		400		300		250	ns
$t_{CO}$	Chip Enable to Output ON Delay (Note 1)		800		400		350		200		175		150		125	ns
$t_{OD}$	Output Disable to Output ON Delay		700		350		300		175		150		125		100	ns
$t_{OH}$	Previous Read Data Valid with Respect to Address Change	0		0		0		40		40		40		30		ns
$t_{DF1}$	Output Disable to Output OFF Delay	0	200	0	150	0	150	5.0	125	5.0	100	5.0	100	5.0	75	ns
$t_{DF2}$	Chip Enable to Output OFF Delay	0	200	0	150	0	150	10	125	10	125	10	100	10	100	ns
$t_{WC}$	Write Cycle Time	1000		650		500		500		400		300		250		ns
$t_{AW}$	Address Set-up Time	150		150		100		0		0		0		0		ns
$t_{WP}$	Write Pulse Width	750		400		300		175		150		125		100		ns
$t_{CW}$	Chip Enable Set-up Time (Note 1)	900		550		400		175		150		125		100		ns
$t_{WR}$	Address Hold Time	50		50		50		0		0		0		0		ns
$t_{DW}$	Input Data Set-up Time	700		400		280		150		125		100		85		ns
$t_{DH}$	Input Data Hold Time	100		100		100		0		0		0		0		ns

Note: 1. Both CE1 and CE2 must be true to enable the chip.

2

**SWITCHING WAVEFORMS**

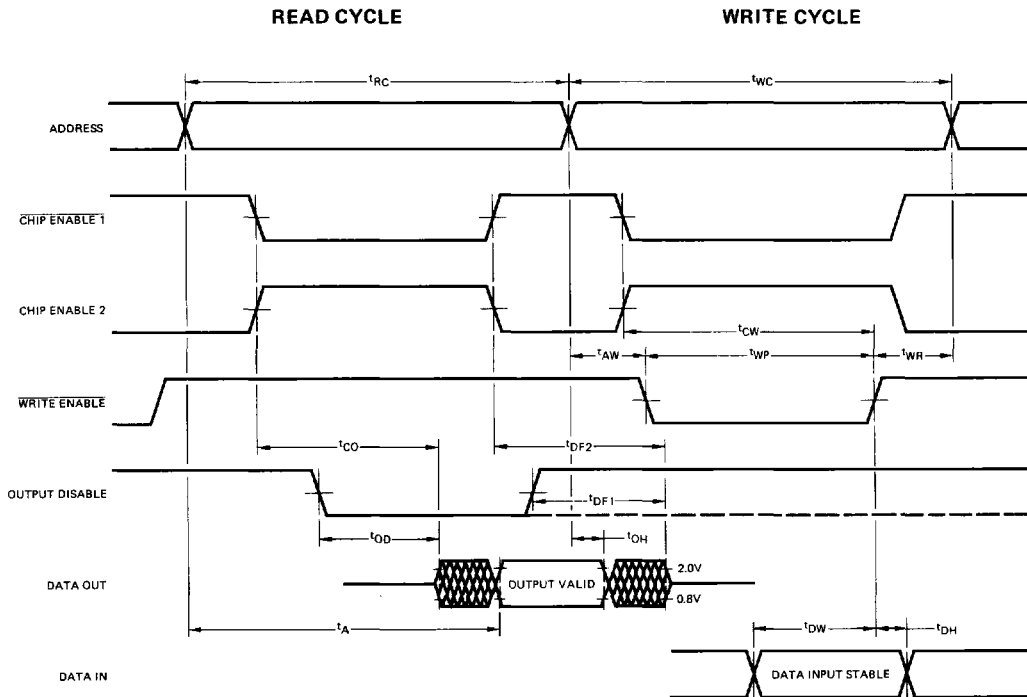

MOS-345

## CONNECTION DIAGRAM

Top View

Flat Package

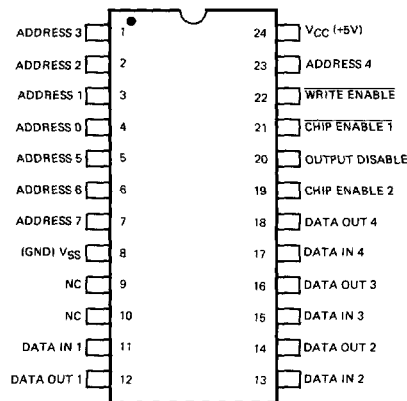

Pin 1 is marked for orientation.

MOS-346

## DEFINITION OF TERMS

## FUNCTIONAL TERMS

**$\overline{CE1}$ ,  $CE2$**  Chip Enable Signals. Read and Write cycles can be executed only when both  $\overline{CE1}$  is low and  $CE2$  is high.

**$\overline{WE}$**  Active LOW Write Enable. Data is written into the memory if  $\overline{WE}$  is LOW and read from the memory if  $\overline{WE}$  is HIGH.

**Static RAM** A random access memory in which data is stored in bistable latch circuits. A static memory will store data as long as power is supplied to the chip without requiring any special clocking or refreshing operations.

**N-Channel** An insulated gate field effect transistor technology in which the transistor source and drain are made of N-type material, and electrons serve as the carriers between the two regions. N-Channel transistors exhibit lower thresholds and faster switching speeds than P-Channel transistors.

## SWITCHING TERMS

**$t_{OD}$**  Output enable time. Delay time from falling edge of OD to output on.

**$t_{RC}$**  Read Cycle Time. The minimum time required between successive address changes while reading.

**$t_A$**  Access Time. The time delay between application of an address and stable data on the output when the chip is enabled.

**$t_{CO}$**  Access Time from Chip Enable. The minimum time during which the chip enable must be LOW prior to reading data on the output.

**$t_{OH}$**  Minimum time which will elapse between change of address and any change of the data output.

**$t_{DF1}$**  Time delay between output disable HIGH and output data float.

**$t_{DF2}$**  Time delay between chip enable OFF and output data float.

**$t_{WC}$**  Write Cycle Time. The minimum time required between successive address changes while writing.

**$t_{AW}$**  Address Set-up Time. The minimum time prior to the falling edge of the write enable during which the address inputs must be correct and stable.

**$t_{WP}$**  The minimum duration of a LOW level on the write enable guaranteed to write data.

**$t_{WR}$**  Address Hold Time. The minimum time after the rising edge of the write enable during which the address must remain steady.

**$t_{DW}$**  Data Set-up Time. The minimum time that the data input must be steady prior to the rising edge of the write enable.

**$t_{DH}$**  Data Hold Time. The minimum time that the data input must remain steady after the rising edge of the write enable.

**$t_{CW}$**  Chip Enable Time during Write. The minimum duration of a LOW level on the Chip Select prior to the rising edge of  $\overline{WE}$  to guarantee writing.

**POWER DOWN STANDBY OPERATION**

The Am9101/Am91L01 Family is designed to maintain storage in a standby mode. The standby mode is entered by lowering  $V_{CC}$  to around 1.5–2.0 volts (see table and graph below). When the voltage to the device is reduced, the storage cells are isolated from the data lines, so their contents will not change. The standby mode may be used by a battery operated backup power supply system, or, in a

large system, memory pages not being accessed can be placed in standby to save power. A standby recovery time must elapse following restoration of normal power before the memory may be accessed.

To ensure that the output of the device is in a high impedance OFF state during standby, the chip select should be held at  $V_{IH}$  or  $V_{CES}$  during the entire standby cycle.

**STANDBY OPERATING CONDITIONS OVER TEMPERATURE RANGE**

Parameters	Description	Test Conditions	Min.	Typ.	Max.	Units	
$V_{PD}$	$V_{CC}$ in Standby Mode		1.5				
$I_{PD}$	$I_{CC}$ in Standby Mode	$T_A = 0^\circ\text{C}$ All Inputs = $V_{PD}$	$V_{PD} = 1.5\text{V}$	Am91L01	11	25	mA
				Am9101	13	31	
		$V_{PD} = 2.0\text{V}$	Am91L01	13	31	mA	
			Am9101	17	41		
		$T_A = -55^\circ\text{C}$ All Inputs = $V_{PD}$	$V_{PD} = 1.5\text{V}$	Am91L01	11	28	mA
				Am9101	13	34	
$V_{PD} = 2.0\text{V}$	Am91L01	13	34	mA			
	Am9101	17	46				
$dv/dt$	Rate of Change of $V_{CC}$				1.0	V/ $\mu\text{s}$	
$t_R$	Standby Recovery Time		$t_{RC}$			ns	
$t_{CP}$	Chip Deselect Time		0			ns	
$V_{CES}$	$\overline{CE}$ Bias in Standby		$V_{PD}$			Volts	

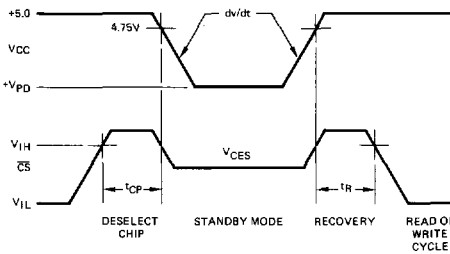

Typical Power Supply Current Versus Voltage

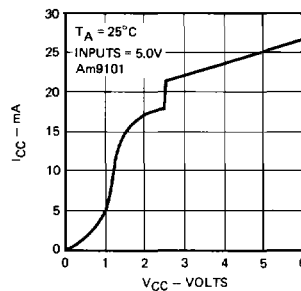

Typical Output Current Versus Voltage

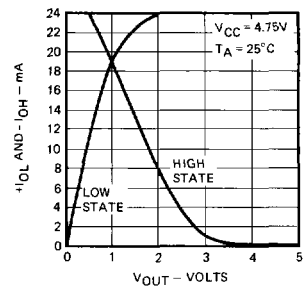

Metallization and Pad Layout

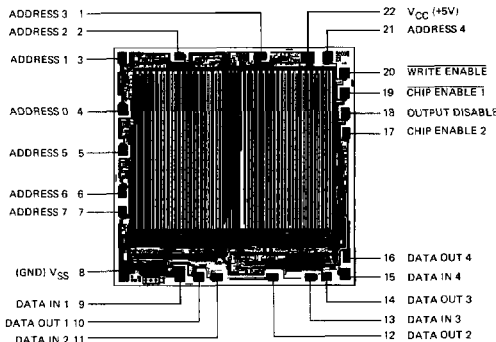

DIE SIZE 0.132" X 0.131"  
(Pin numbers are for DIP configurations only)

Access Time Versus  $V_{CC}$  Normalized to  $V_{CC} = +5.0$  Volts

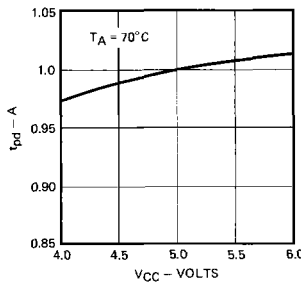

Typical Power Supply Current Versus Ambient Temperature

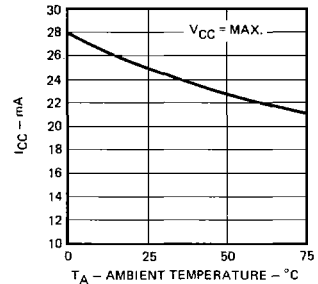

APPLICATIONS

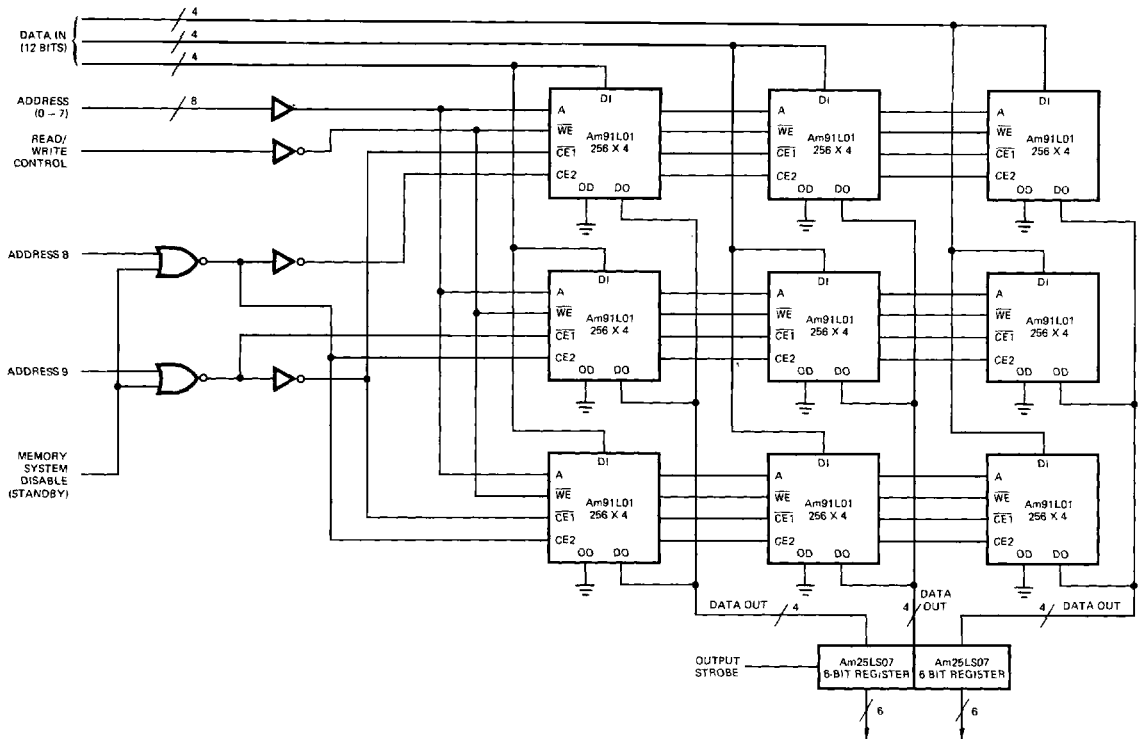

MEMORY SYSTEM  
768 WORDS BY 12 BITS PER WORD

MOS-348

Typical  $V_{IN}$  Limits  
Versus Ambient Temperature

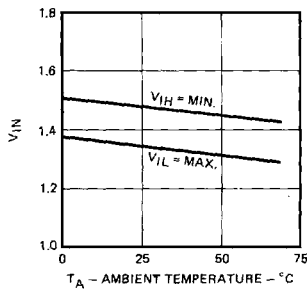

Typical  $t_A$  Versus  
Ambient Temperature

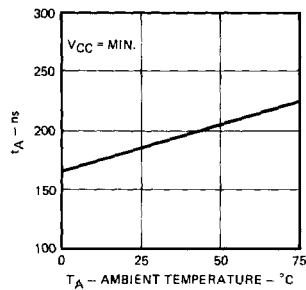

Typical  $t_A$  Versus  $C_L$

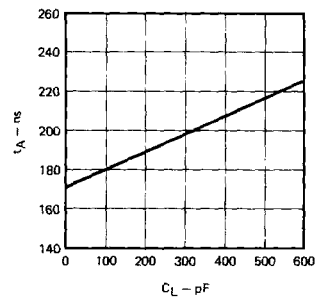

MOS-349