



DESCRIPTION

The AM9435 is the P-Channel logic enhancement mode power field effect transistor is produced using high cell density, advanced trench technology to provide excellent $R_{DS(ON)}$.

This device is suitable for use as a load switch or in PWM and gate charge for most of the synchronous buck converter applications.

The AM9435 is available in SOP8 Package

ORDERING INFORMATION

Package Type	Part Number	
SOP8	M8	AM9435M8R
		AM9435M8VR
Note	R: Tape & Reel V: Halogen free Package	
AiT provides all RoHS products Suffix " V " means Halogen free Package		

FEATURES

- -30V/-5.8A, $R_{DS(ON)}=38m\Omega(\text{typ.})@V_{GS}=-10V$
-30V/-4.0A, $R_{DS(ON)}=60m\Omega(\text{typ.})@V_{GS}=-4.5V$
- Super high density cell design for extremely low $R_{DS(ON)}$
- Exceptional on-resistance and maximum DC current capability
- Available in SOP8 Package

APPLICATION

- Power Management in Note book
- Portable Equipment
- DSC
- LCD Display inverter
- Battery Powered System
- DC/DC Converter
- Load Switch

P-CHANNEL MOSFET

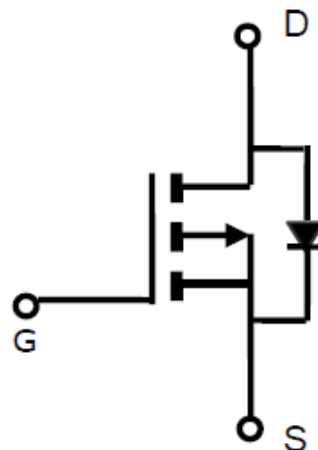



PIN DESCRIPTION

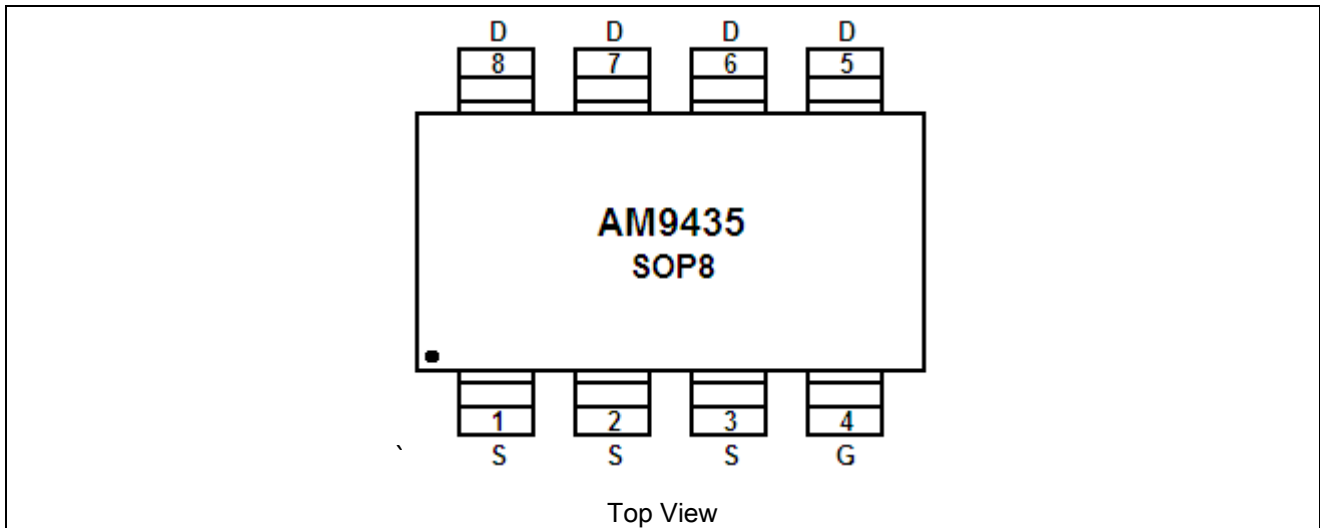

Top View

Pin #	Symbol	Function
1	S	Source
2	S	Source
3	S	Source
4	G	Gate
5	D	Drain
6	D	Drain
7	D	Drain
8	D	Drain



ABSOLUTE MAXIMUM RATINGS

T_A = 25°C Unless otherwise noted

V _{DSS} , Drain-Source Voltage		-30V
V _{GSS} , Gate-Source Voltage		±20V
I _D , Continuous Drain Current, V _{GS} =10V ^{NOTE1}	T _A =25°C	-5.8A
	T _A =70°C	-4.2A
I _{DM} , Pulsed Drain Current ^{NOTE2}		-12A
E _{AS} , Single Pulse Avalanche energy L=0.1mH ^{NOTE3}		60mJ
P _D , Power Dissipation	T _A =25°C	2.05W
	T _A =70°C	1.5W
T _J , Operation Junction Temperature		-55°C~150°C
T _{STG} , Storage Temperature Range		-55°C~150°C

Stresses above may cause permanent damage to the device. These are stress ratings only and functional operation of the device at these or any other conditions beyond those indicated in the Electrical Characteristics are not implied. Exposure to absolute maximum rating conditions for extended periods may affect device reliability.

NOTE1: The value of R_{θJA} is measured with the device mounted on 1in 2 FR-4 board with 2oz. copper, in a still air environment with T_A=25°C.

NOTE2: The data tested by pulsed, pulse width ≤ 300uS, duty cycle ≤ 2 %.

NOTE3: The EAS data shows Max. rating. The test condition is V_{DD}=-25V, V_{GS}=-10V, L=0.1mH.

THERMAL INFORMATION

Parameter	Symbol	Min	Typ	Max	Unit
Thermal Resistance-Junction to Ambient	R _{θJA}			85	°C/W
Thermal Resistance-Junction to Case	R _{θJC}			58	°C/W



ELECTRICAL CHARACTERISTICS

T_A = 25°C Unless otherwise noted

Parameter	Symbol	Conditions	Min	Typ	Max	Unit
Static Parameters						
Drain-Source Breakdown Voltage	V _{(BR)DSS}	V _{GS} = 0V, I _D = -250μA	-30	-	-	V
Gate Threshold Voltage	V _{GS(th)}	V _{DS} = V _{GS} , I _D = -250μA	-1.0	-	-2.5	V
Gate Leakage Current	I _{GSS}	V _{DS} = 0V, V _{GS} = ±20V	-	-	±100	nA
Zero Gate Voltage Drain Current	I _{DSS}	V _{DS} = -24V, V _{GS} = 0V	-	-	-1	μA
		V _{DS} = -24V, V _{GS} = 0V	-	-	-5	
		T _J = 55°C	-	-	-	
Drain-source On-Resistance ^{NOTE2}	R _{DS(ON)}	V _{GS} = -10V, I _D = -5.8A	-	38	48	mΩ
		V _{GS} = -4.5V, I _D = -4.0A	-	60	78	
Forward Transconductance	G _{FS}	V _{DS} = -10V, I _D = -5.8A	-	6	-	S
Source-Drain Diode						
Diode Forward Voltage	V _{SD}	I _S = -2.0A, V _{GS} = 0V	-	-0.7	-1.2	V
Continuous Source Current ^{NOTE1,4}	I _S				-6	A
Dynamic Parameters						
Total Gate Charge	Q _G	V _{DS} = -20V, V _{GS} = -10V I _D = -5.8A	-	6.2	-	nC
Gate-Source Charge	Q _{GS}		-	2.5	-	
Gate-Drain Charge	Q _{GD}		-	3.3	-	
Input Capacitance	C _{ISS}	V _{DS} = -15V, V _{GS} = 0V f = 1MHz	-	640	-	pF
Output Capacitance	C _{OSS}		-	270	-	
Reverse Transfer Capacitance	C _{RSS}		-	103	-	
Turn-On Time	t _{D(ON)}	V _{DD} = 15V, V _{GS} = -10V, I _D = -5A, R _G = 3.3Ω	-	9.2	-	nS
	t _R		-	16.5	-	
Turn-Off Time	t _{D(OFF)}		-	21.3	-	
	t _F		-	21.5	-	

NOTE4: The data is theoretically the same as I_D and I_{DM}, in real applications, should be limited by total power dissipation.



TYPICAL CHARACTERISTICS

1. Output Characteristics

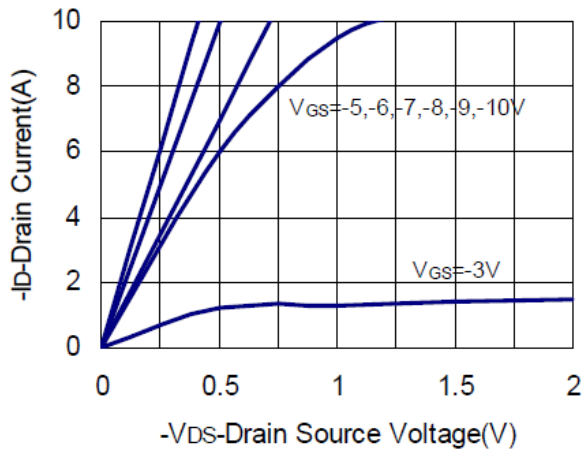

2. Transfer Characteristics

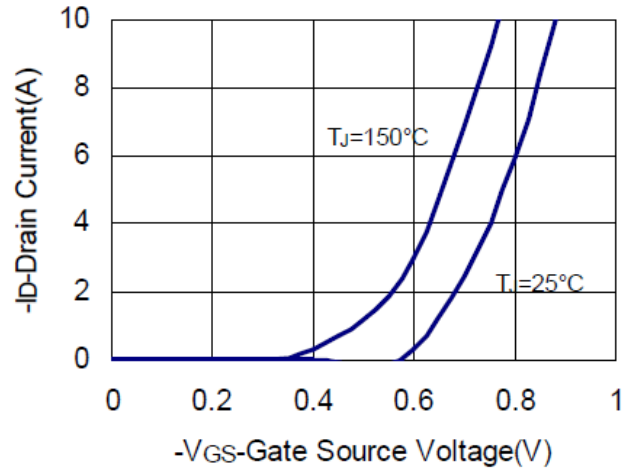

3. Drain Source On Resistance

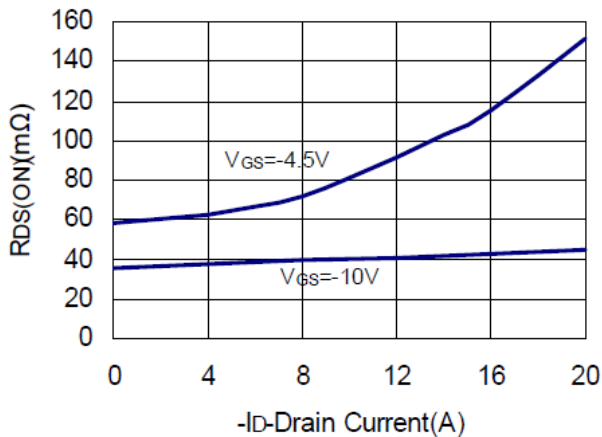

4. Gate Threshold Voltage

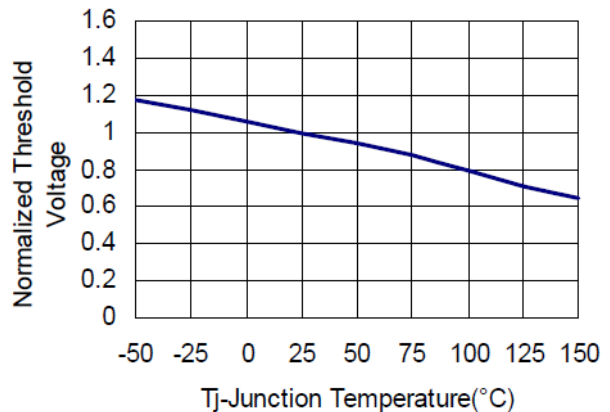

5. Gate Charge

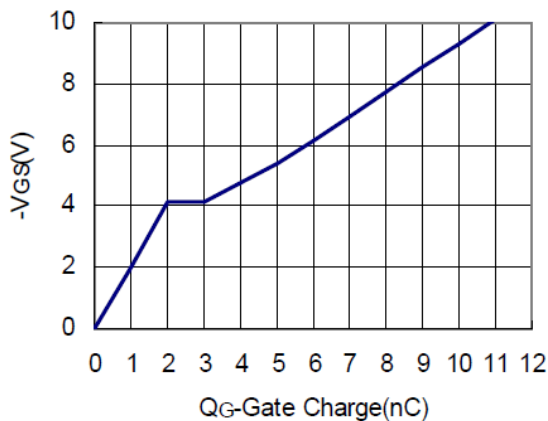

6. Drain Source On Resistance

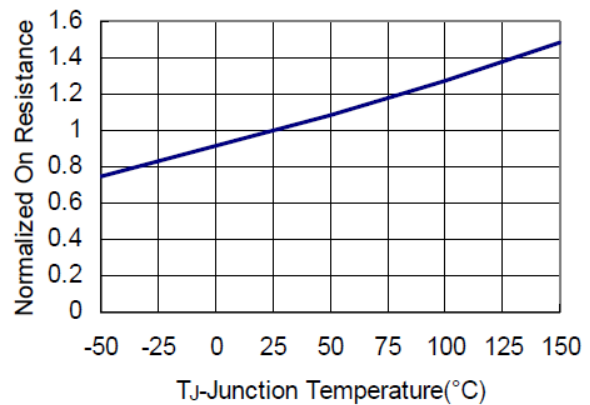



7. Source Drain Diode Forward

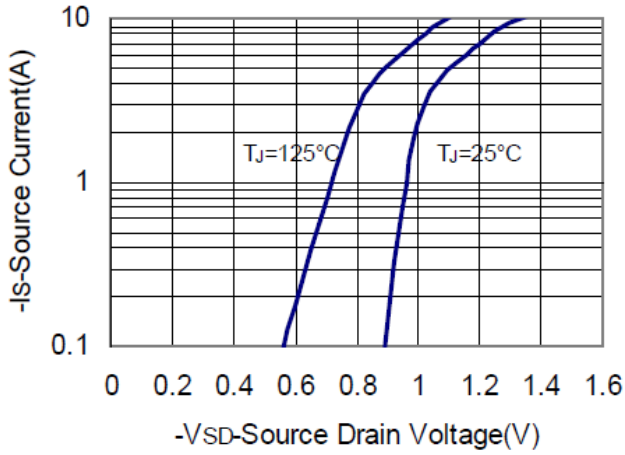

8. Capacitance

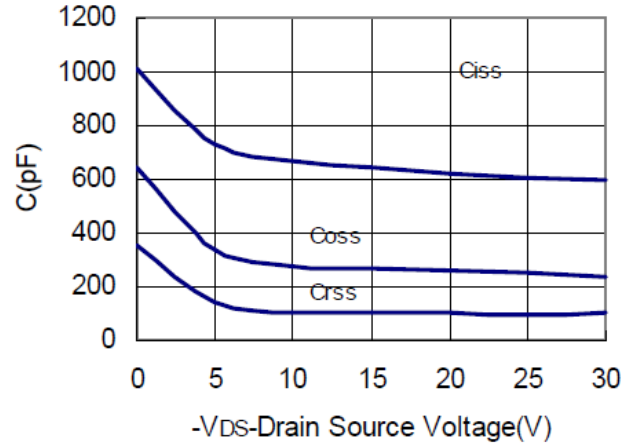

9. Power Dissipation

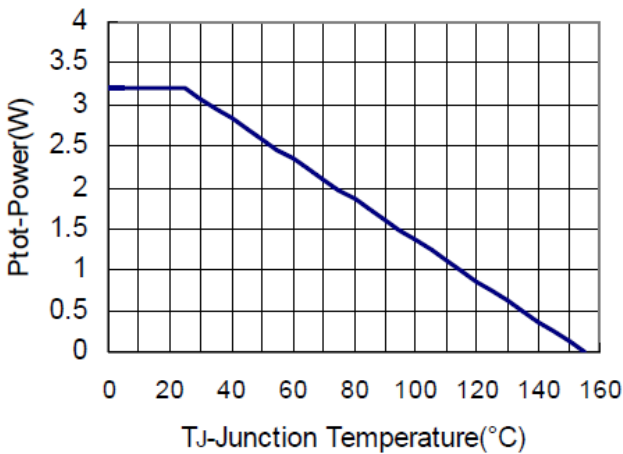

10. Drain Current

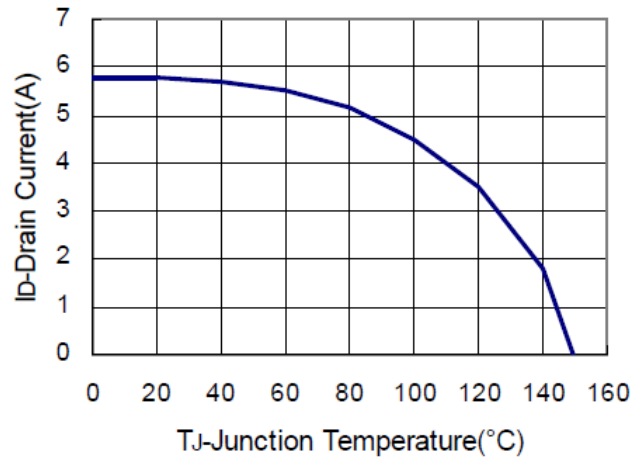

11. Thermal Transient Impedance

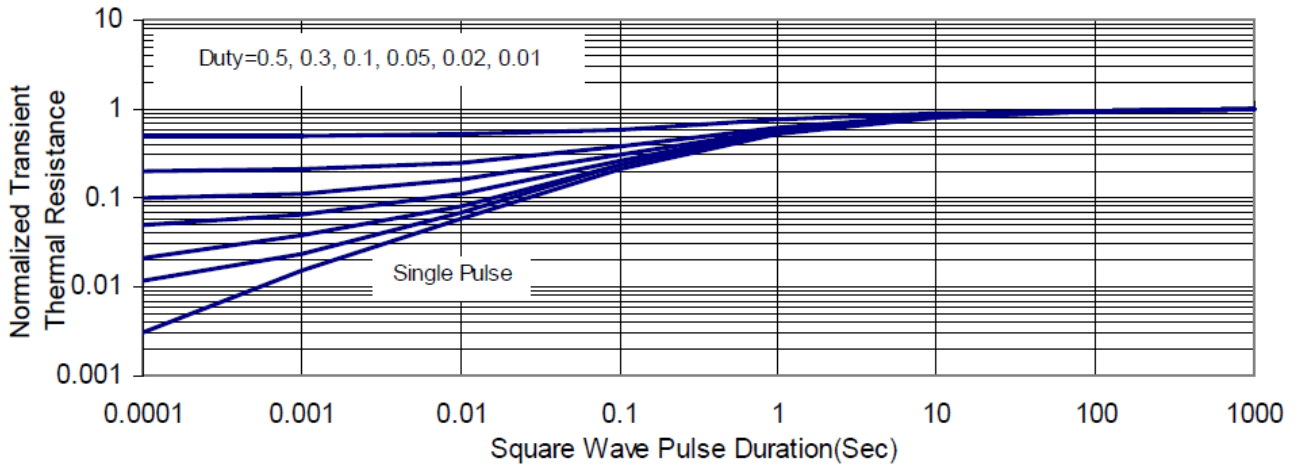



PACKAGE INFORMATION

Dimension in SOP8 (Unit: mm)

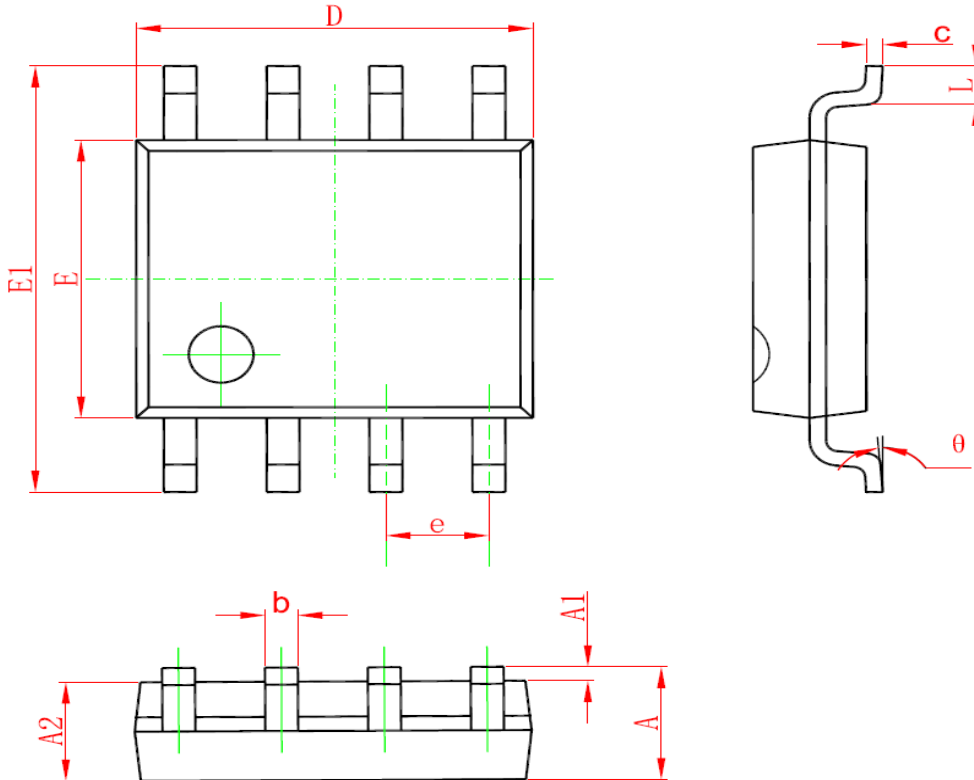

Symbol	Min	Max
A	1.400	1.750
A1	0.100	0.250
A2	1.300	1.500
b	0.330	0.510
c	0.190	0.250
D	4.800	5.300
E	3.700	4.100
E1	5.790	6.200
e	1.270(BSC)	
L	0.380	1.270
θ	0°	8°



IMPORTANT NOTICE

AiT Semiconductor Inc. (AiT) reserves the right to make changes to any its product, specifications, to discontinue any integrated circuit product or service without notice, and advises its customers to obtain the latest version of relevant information to verify, before placing orders, that the information being relied on is current.

AiT Semiconductor Inc.'s integrated circuit products are not designed, intended, authorized, or warranted to be suitable for use in life support applications, devices or systems or other critical applications. Use of AiT products in such applications is understood to be fully at the risk of the customer. As used herein may involve potential risks of death, personal injury, or severe property, or environmental damage. In order to minimize risks associated with the customer's applications, the customer should provide adequate design and operating safeguards.

AiT Semiconductor Inc. assumes to no liability to customer product design or application support. AiT warrants the performance of its products of the specifications applicable at the time of sale.