



AMC1117

1A LOW DROPOUT POSITIVE REGULATOR

DESCRIPTION
<p>The AMC1117 series of positive adjustable and fixed regulators is designed to provide 1A for applications requiring high efficiency. All internal circuitry is designed to operated down to 800mV input to output differential and the dropout voltage is fully specified as a function of load current.</p> <p>The AMC1117 offers current limiting and thermal protection. The on chip trimming adjusts the reference voltage accuracy to 1%.</p>

FEATURES
<ul style="list-style-type: none"> ■ Output current of 1A typical ■ Three-terminal adjustable or fixed 1.8V, 2.5V, 2.85V, 3.3V, 5.0V outputs ■ Low dropout of typical 800mV ■ Thermal protection built in ■ Typical 0.015% line regulation ■ Typical 0.01% load regulation □ Fast transient response □ Available in SOT-223 and TO-252 packages □ Pin assignment identical to earlier LT1117 series

APPLICATIONS
<ul style="list-style-type: none"> ■ 2.85V Model for SCSI-2 Active Termination ■ Battery Charger ■ High Efficiency Linear Regulators ■ Battery Powered Instrumentation ■ Post Regulator for Switching DC/DC Converter <p>◆ Voltage Options</p> <p>AMC1117-1.8 – 1.8V Fixed AMC1117-2.5 – 2.5V Fixed AMC1117-2.85 – 2.85V Fixed AMC1117-3.3 – 3.3V Fixed AMC1117-5.0 – 5.0V Fixed AMC1117 – Adjustable Output</p>

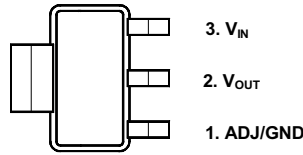
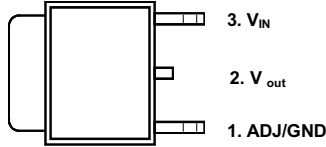
PACKAGE PIN OUT
 <p>3-Pin Plastic SOT-223 Surface Mount (Top View)</p>
 <p>3-Pin Plastic TO-252 Surface Mount (Top View)</p>

ORDER INFORMATION			
T _A (°C)	SK	SOT223	SJ
		3-pin	
0 to 70	AMC1117-X.XSK		AMC1117-X.XSJ
	AMC1117SK		AMC1117SJ
Note: All surface-mount packages are available in Tape & Reel. Append the letter "T" to part number (i.e. AMC1117-X.XSJT).			

AMC1117
1A LOW DROPOUT
POSITIVE REGULATOR

BLOCK DIAGRAM

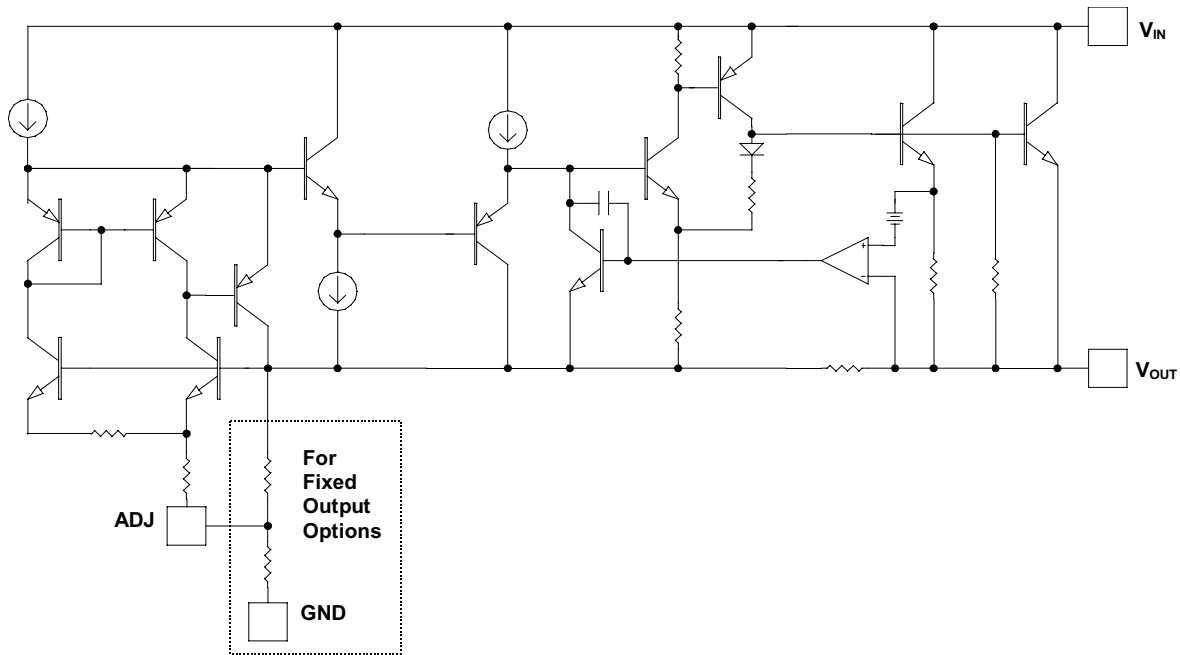

AMC1117
1A LOW DROPOUT
POSITIVE REGULATOR

ABSOLUTE MAXIMUM RATINGS (Note 1)	
Input Voltage	13V
Operating Junction Temperature Range, T _J	0°C to 150°C
Storage Temperature Range	-65°C to 150°C
Lead Temperature (soldering, 10 seconds)	260°C
Note 1: Exceeding these ratings could cause damage to the device. All voltages are with respect to Ground. Currents are positive into, negative out of the specified terminal.	

POWER DISSIPATION TABLE					
Package	θ _{JA} (°C/W)	Derating factor (mW/°C) T _A ≥ 25°C	T _A ≤ 25°C	T _A = 70°C	T _A = 85°C
			Power rating(mW)	Power rating(mW)	Power rating (mW)
SK	136	7.35	919	588	478
SJ	80	12.5	1562	1000	812
Note : 1. θ _{JA} : Thermal Resistance-Junction to Ambient, D _F : Derating factor, Po: Power consumption. Junction Temperature Calculation: T _J = T _A + (P _D x θ _{JA}), Po = D _F x (T _J - T _A) The θ _{JA} numbers are guidelines for the thermal performance of the device/PC-board system. All of the above assume no ambient airflow. 2. θ _{JT} : Thermal Resistance-Junction to Ambient, T _C : case(Tab) temperature, T _J = T _C + (P _D x θ _{JT}) For SK package, θ _{JT} = 15.0°C/W. For SJ package, θ _{JT} = 7.0°C/W.					

RECOMMENDED OPERATING CONDITIONS					
Parameter	Symbol	Recommended Operating Conditions			Units
		Min.	Typ.	Max.	
Input Voltage	V _{IN}	2.7		12	V
Load Current (with adequate heatsinking)	I _O	5			mA
Input Capacitor (V _{IN} to GND)		1.0			µF
Output Capacitor with ESR of 10Ω max., (V _{OUT} to GND)		4.7			µF
Junction temperature	T _J			125	°C

ELECTRICAL CHARACTERISTICS							
Unless otherwise specified, $V_{IN} = V_{OUT} + 2V$, $I_O = 10mA$, and $T_J = 25^\circ C$.							
Parameter	Symbol	Test Conditions	AMC1117			Units	
			Min	Typ	Max		
Reference Voltage	AMC1117	V_{REF}	$I_O = 10mA, V_{IN} - V_{OUT} = 2V$	1.238	1.250	1.262	V
			$10mA \leq I_O \leq 1A, V_{OUT} + 1.5V \leq V_{IN} \leq 12V$	1.230	1.250	1.270	
Output Voltage	AMC1117-1.8	V_{OUT}	$I_O = 10mA, V_{IN} = 3.8V$	1.782	1.8	1.818	V
			$10mA \leq I_O \leq 1A, 3.2V \leq V_{IN} \leq 12V$	1.764	1.8	1.836	
	AMC1117-2.5		$I_O = 10mA, V_{IN} = 4.5V$	2.475	2.500	2.525	
			$10mA \leq I_O \leq 1A, 4.25V \leq V_{IN} \leq 12V$	2.450	2.500	2.550	
	AMC1117-2.85		$I_O = 10mA, V_{IN} = 4.85V$	2.821	2.850	2.879	
			$10mA \leq I_O \leq 1A, 4.25V \leq V_{IN} \leq 12V$	2.805	2.850	2.895	
	AMC1117-3.3		$I_O = 10mA, V_{IN} = 5.0V$	3.267	3.300	3.333	
			$10mA \leq I_O \leq 1A, 4.75V \leq V_{IN} \leq 12V$	3.235	3.300	3.365	
AMC1117-5.0	$I_O = 10mA, V_{IN} = 7.0V$	4.950	5.000	5.050			
	$10mA \leq I_O \leq 1A, 6.5V \leq V_{IN} \leq 12V$	4.900	5.000	5.100			
Line Regulation	AMC1117	ΔV_{OI}	$I_O = 10mA, V_{OUT} + 1.5V \leq V_{IN} \leq 12V$		0.04	0.20	%
	AMC1117-X.X		$I_O = 10mA, V_{OUT} + 1.5V \leq V_{IN} \leq 12V$		1.0	6.0	mV
Load Regulation	AMC1117	ΔV_{OL}	$10mA \leq I_O \leq 1A, V_{IN} - V_{OUT} = 3V$		0.10	0.40	%
	AMC1117-X.X		$10mA \leq I_O \leq 1A, V_{IN} = V_{OUT} + 1.5V$		1.0	10.0	mV
Dropout Voltage		ΔV	$I_O = 10mA$		0.8	1.15	V
			$I_O = 1A$		0.8	1.30	
Minimum Load Current (Note 1)			$V_{IN} \leq 12V$		1.7	5	mA
Quiescent Current	AMC1117-X.X	I_Q	$V_{IN} \leq 12V$		6	10	mA
Current Limit		I_{CL}	$V_{IN} - V_{OUT} = 3V$	1	1.2		A
Adjust Pin Current			$I_O = 10mA, V_{IN} - V_{OUT} = 2V$		50	120	μA
Thermal Regulation (Note 2)			$T_A = 25^\circ C, 30 \text{ ms pulse}$		0.01	0.1	%/W
Ripple rejection (Note 2)		R_R	$f_O = 120Hz, 1V_{RMS}, I_O = 400mA, V_{IN} - V_{OUT} = 3V$	60	75		dB

Note 1: For the adjustable device, the minimum load current is the minimum current required to maintain regulation. Normally the current in the resistor divider used to set the output voltage is selected to meet the minimum load current requirement.

Note 2: These parameters, although guaranteed, are not tested in production.

Characterization Curves

Unless otherwise specified, $V_{IN} = V_{OUT} + 2V$, $C_{IN} = 1\mu F$, $C_{OUT} = 4.7\mu F$, $T_A = 25^\circ C$

Load Regulation

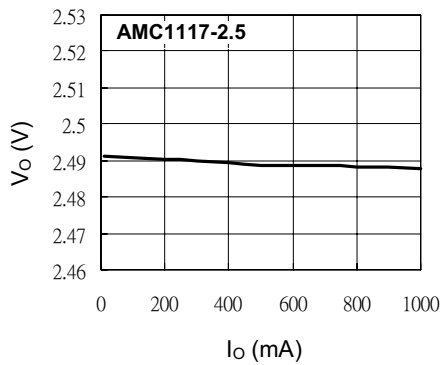

Load Regulation

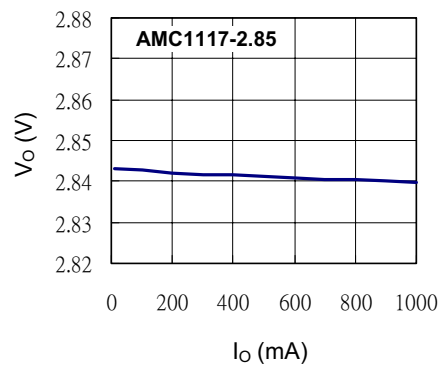

Load Regulation

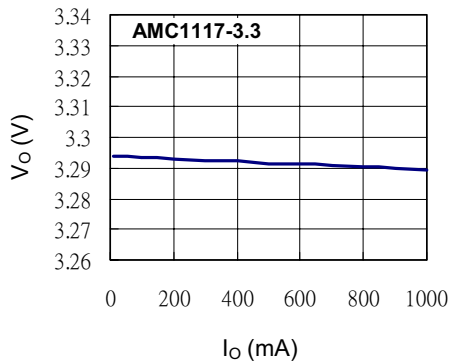

Load Regulation

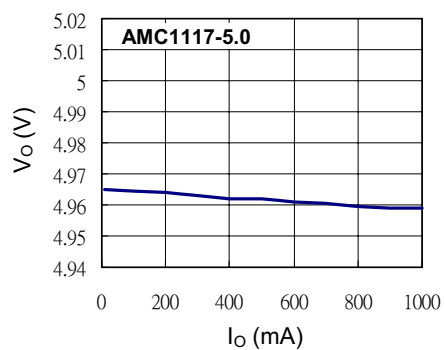

Temperature Stability

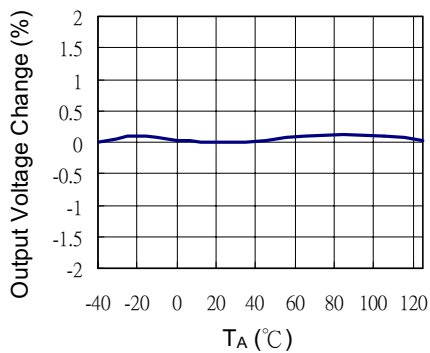

Quiescent Current vs. Temperature

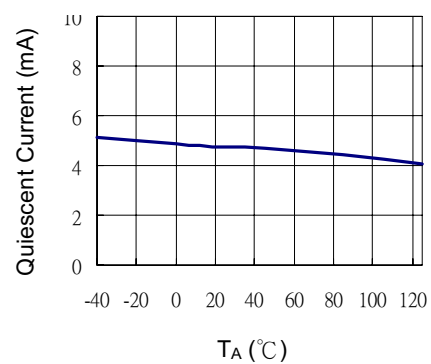

APPLICATION INFORMATION

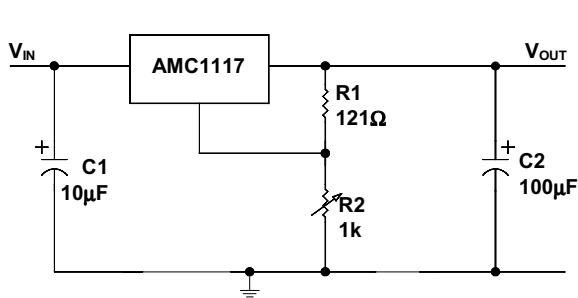

Adjustable Regulator

$$V_{OUT} = 1.25V \left(1 + \frac{R2}{R1} \right)$$

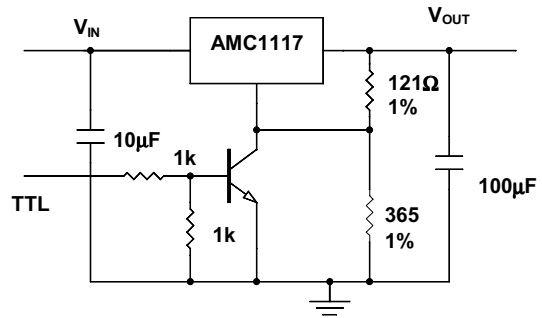

5V Regulator with Shutdown

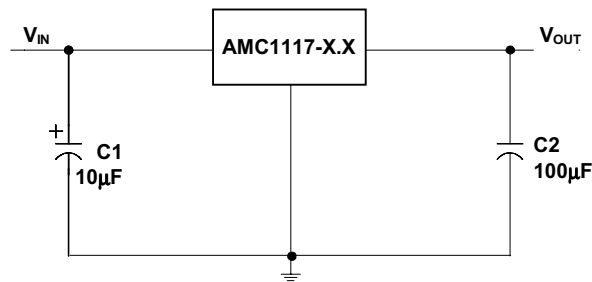

Fixed Voltage Regulator

Application Note:

Maximum Power Calculation:

$$P_{D(MAX)} = \frac{T_{J(MAX)} - T_{A(MAX)}}{\theta_{JA}}$$

$T_J(^{\circ}C)$: Maximum recommended junction temperature

$T_A(^{\circ}C)$: Ambient temperature of the application

$\theta_{JA}(^{\circ}C/W)$: Junction-to-junction temperature thermal resistance of the package, and other heat dissipating materials.

The maximum power dissipation of a single-output regulator :

$$P_{D(MAX)} = [(V_{IN(MAX)} - V_{OUT(NOM)}) \times I_{OUT(NOM)} + V_{IN(MAX)} \times I_Q]$$

Where: $V_{OUT(NOM)}$ = the nominal output voltage

$I_{OUT(NOM)}$ = the nominal output current, and

I_Q = the quiescent current the regulator consumes at $I_{OUT(MAX)}$

$V_{IN(MAX)}$ = the maximum input voltage

Then $\theta_{JA} = (150^{\circ}C - T_A) / P_D$

Thermal consideration:

When power consumption is over about 404 mW (for SOT-223 package, 687mW for TO-252 package, at $T_A=70^{\circ}C$), additional heat sink is required to control the junction temperature below $125^{\circ}C$.

The junction temperature is: $T_J = P_D (\theta_{JT} + \theta_{CS} + \theta_{SA}) + T_A$

$P_D \equiv$ Dissipated power.

$\theta_{JT} \equiv$ Thermal resistance from the junction to the mounting tab of the package.

$\theta_{CS} \equiv$ Thermal resistance through the interface between the IC and the surface on which it is mounted.
 (typically, $\theta_{CS} < 1.0^{\circ}C/W$)

$\theta_{SA} \equiv$ Thermal resistance from the mounting surface to ambient (thermal resistance of the heat sink).

If PC Board copper is going to be used as a heat sink, below table can be used to determine the appropriate size of copper foil required. For multi-layered PCB, these layers can also be used as a heat sink. They can be connected with several through hole vias.

PCB $\theta_{SA} (^{\circ}C/W)$	59	45	38	33	27	24	21
PCB heat sink size (mm ²)	500	1000	1500	2000	3000	4000	5000

Recommended figure of PCB area used as a heat sink.

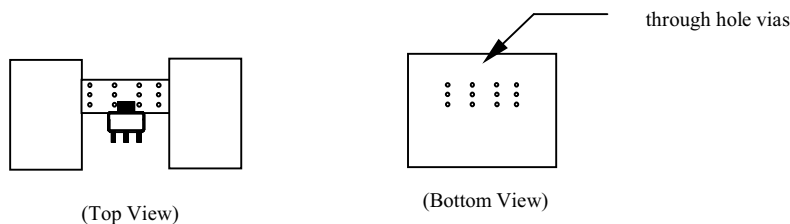

AMC1117
1A LOW DROPOUT
POSITIVE REGULATOR

3-Pin Surface Mount SOT-223 (SK)

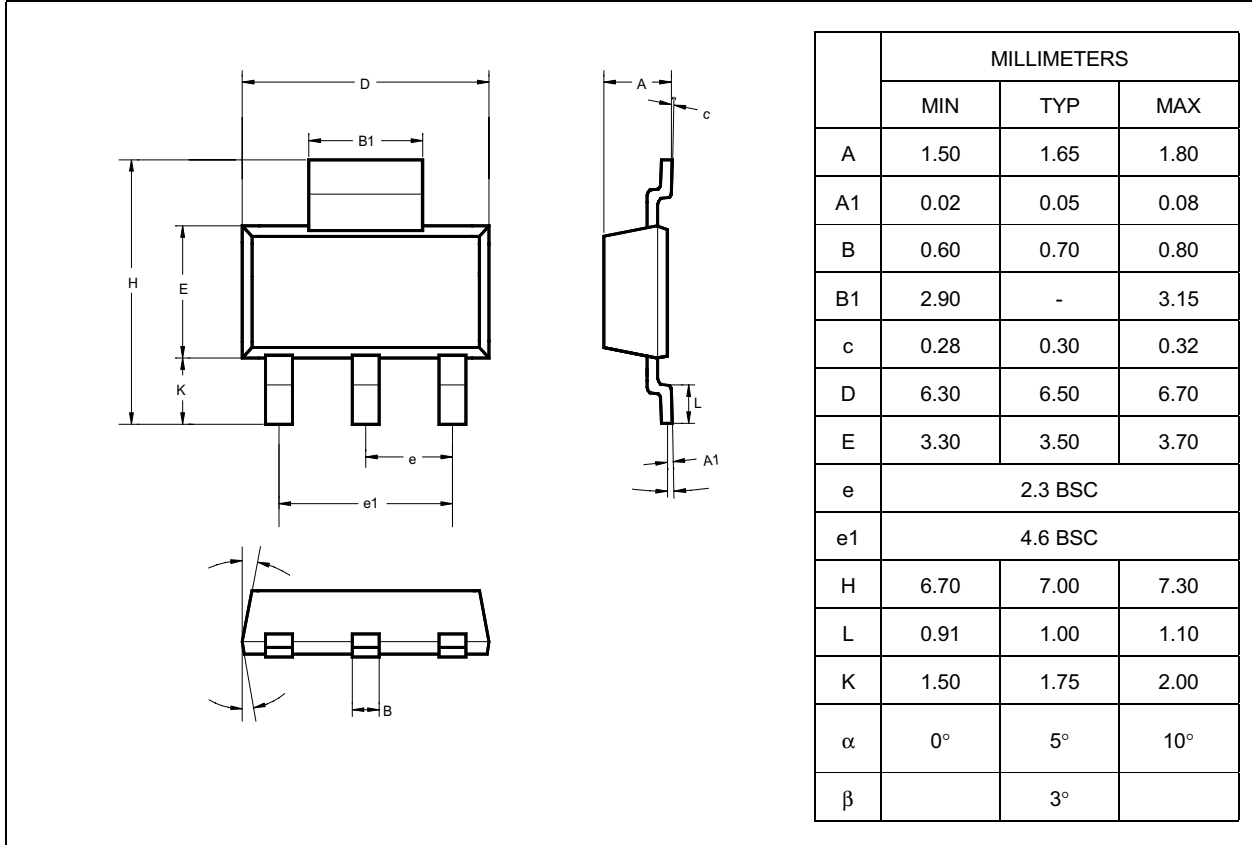

3-Pin Surface Mount TO-252 (SJ)

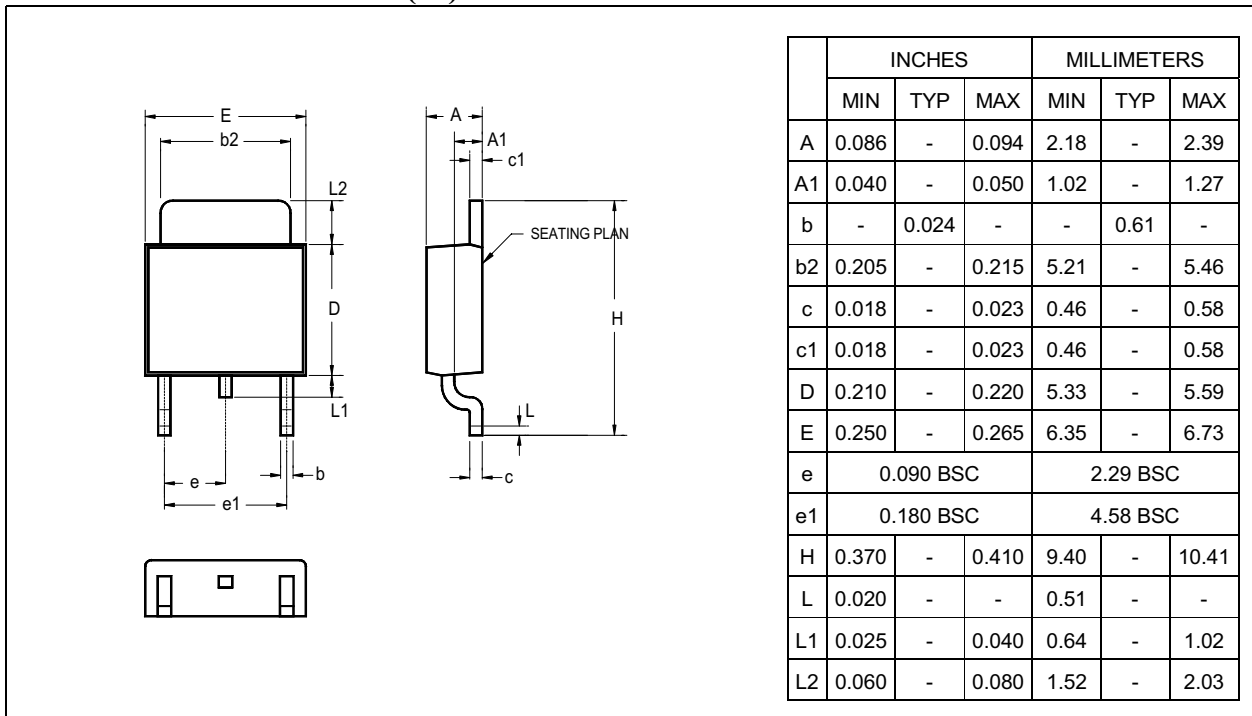

IMPORTANT NOTICE

ADD Microtech (ADDM) reserves the right to make changes to its products or to discontinue any integrated circuit product or service without notice, and advises its customers to obtain the latest version of relevant information to verify, before placing orders, that the information being relied on is current.

A few applications using integrated circuit products may involve potential risks of death, personal injury, or severe property or environmental damage. ADDM integrated circuit products are not designed, intended, authorized, or warranted to be suitable for use in life-support applications, devices or systems or other critical applications. Use of ADDM products in such applications is understood to be fully at the risk of the customer. In order to minimize risks associated with the customer's applications, the customer should provide adequate design and operating safeguards.

ADDM assumes no liability to customer product design or application support. ADDM warrants the performance of its products to the specifications applicable at the time of sale.

U.S.

ADD Microtech Inc.

492 Altamont Drive
Milpitas, CA 95035

TEL: (408) 9410420
FAX: (408) 9410864

Asia Pacific region

ADD Microtech Corp

3F, 132, Sec. 4, Chung Hsiao E. Rd.,
Taipei, Taiwan

TEL: 2-27760166
FAX: 2-27764208
