



AMC2576

3A STEP DOWN VOLTAGE REGULATOR

DESCRIPTION	FEATURES
<p>The AMC2576 series is a step-down switching regulator with all the required active functions. It is capable of driving 3A load with excellent line and load regulations. These devices are available in fixed output voltages of 3.3V, 5V, and an adjustable output version.</p> <p>The AMC2576 series offers a high-efficiency replacement for popular three-terminal linear regulators. It requires only a minimum number of external components. Substantially, it reduces not only the area of board size but also the size of the heat sink. In some cases, no heat sink is required.</p> <p>The $\pm 4\%$ tolerance on output voltage within specified input voltages and output load conditions is guaranteed. The oscillator frequency accuracy is within $\pm 10\%$. External shutdown is included, featuring 70μA (typical) standby current. The output switch includes cycle-by-cycle current limitation, as well as thermal shutdown for full protection under fault conditions.</p>	<ul style="list-style-type: none"> ■ Guaranteed 3A output current ■ 3.3V, 5V and adjustable output versions ■ Wide input voltage range, up to 40V ■ Internal oscillator of 52 KHz fixed frequency ■ Wide adjustable version output voltage range, from 1.23V to 37V $\pm 4\%$ max over line and load conditions □ Low standby current, typ. 70μA, at shutdown mode □ Requires only 4 external components □ Thermal shut down and current limit protection □ P+ Product enhancement tested

APPLICATIONS
<ul style="list-style-type: none"> ■ LCD Monitors ■ ADD-ON Cards Switching Regulators ■ High Efficiency Step-Down Regulators ■ Efficient Pre-regulator for Linear Regulators ● Voltage Options: <ul style="list-style-type: none"> AMC2576-3.3 – 3.3V Fixed AMC2576-5.0 – 5.0V Fixed AMC2576-ADJ – Adjustable Output

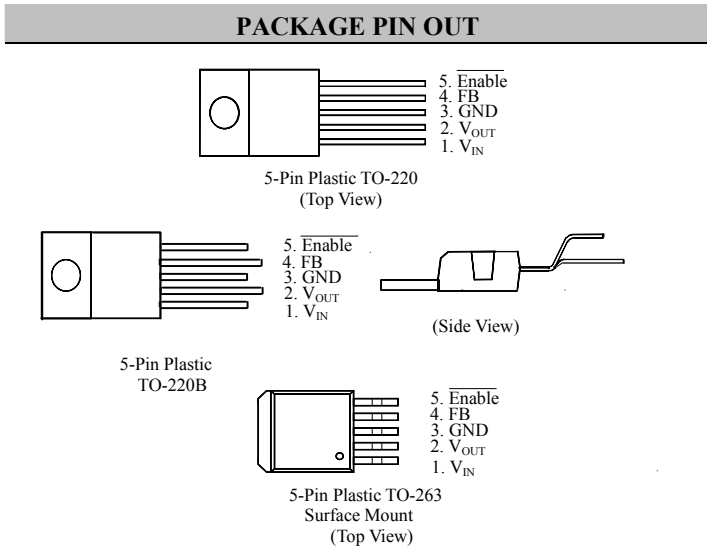

ORDER INFORMATION						
Temperature Range	P	Plastic TO-220	PB	Plastic TO-220B	DD	Plastic TO-263
		5-pin		5-pin		5-pin
-40°C ≤ T _J ≤ 125°C		AMC2576-ADJP		AMC2576-ADJPB		AMC2576-ADJDD
		AMC2576-ADFPF		AMC2576-ADJPBF		AMC2576-ADJDDF
		AMC2576-X.XP		AMC2576-X.XPB		AMC2576-X.XDD
		AMC2576-X.XPF		AMC2576-X.XPBF		AMC2576-X.XDDF
<p>Note: All surface-mount packages are available in Tape & Reel. Append the letter "T" to part number (i.e. AMC2576-X.XDDT). The letter "F" is marked for Lead Free process.</p>						

TYPICAL APPLICATION

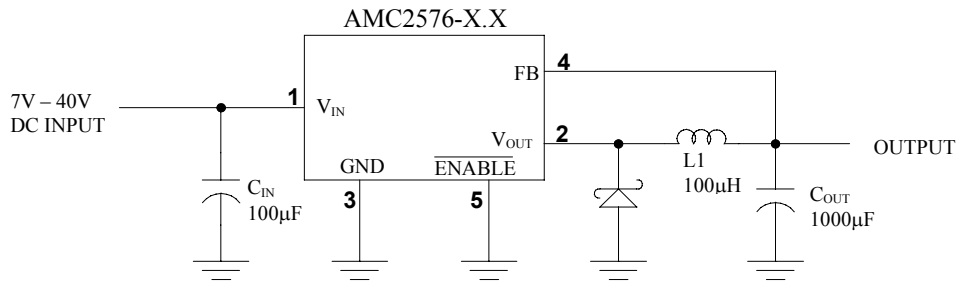

Figure 1. Fixed Output Voltage Versions

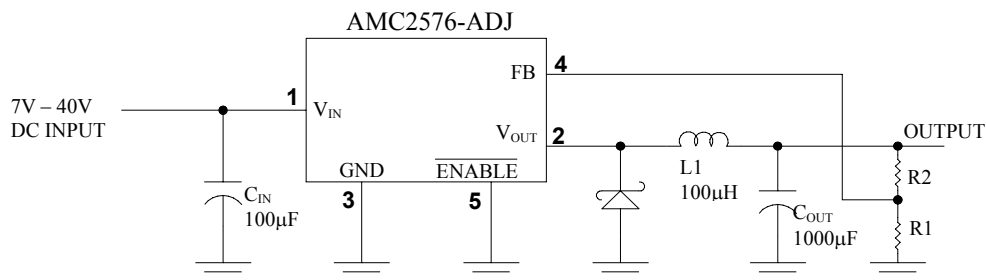

Figure 2. Adjustable Output Voltage Versions

$$V_{OUT} = V_{REF} \left(1 + \frac{R2}{R1} \right)$$

$$R2 = R1 \left(\frac{V_{OUT}}{V_{REF}} - 1 \right)$$

Where $V_{REF} = 1.23V$, $R1$ between 1K and 5K

3A STEP-DOWN VOLTAGE REGULATOR

ABSOLUTE MAXIMUM RATINGS (Note 1)	
Input Voltage, V_{IN}	45V
ENABLE Pin Input Voltage	$-0.3V \leq V \leq V_{IN}$
Operating Junction Temperature, T_J	150°C
Storage Temperature Range	-65°C to 150°C
Lead Temperature (soldering, 10 seconds)	260°C

Note 1: Exceeding these ratings could cause damage to the device. All voltages are with respect to Ground. Currents are positive into, negative out of the specified terminal.

RECOMMENDED OPERATING RATINGS	
Temperature Range	$-40^\circ C \leq T_J \leq 125^\circ C$
Input Voltage, V_{IN}	40V(Max.)

THERMAL DATA	
P,PB, DD PACKAGE:	
Thermal Resistance-Junction to Tab, θ_{JT}	3.0°C /W
Thermal Resistance-Junction to Ambient, θ_{JA}	45°C /W

Junction Temperature Calculation: $T_J = T_A + (P_D \times \theta_{JA})$.
 The θ_{JA} numbers are guidelines for the thermal performance of the device/pc-board system.
 All of the above assume no ambient airflow.

BLOCK DIAGRAM

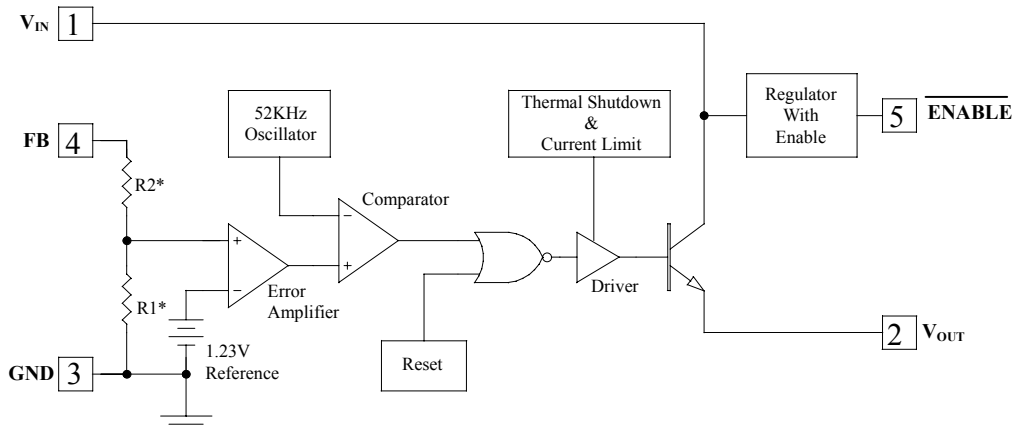

$V_{OUT} = 3.3V$: $R2/R1 = 1.7$
 $V_{OUT} = 5.0V$: $R2/R1 = 3.1$
 $V_{OUT} = \text{Adjustable}$: $R2 = 0$
 R1 = Open

3A STEP-DOWN VOLTAGE REGULATOR

DC ELECTRICAL CHARACTERISTICS								
Unless otherwise specified, these specifications apply $V_{IN} = 12V$, $I_{LOAD} = 0.5A$ and the operating ambient temperatures $T_J = 25^\circ C$.								
Parameter	Symbol	Test Conditions	AMC2576			Units		
			Min	Typ	Max			
Output Voltage (Note 1)	AMC2576-3.3	V_{OUT} Test circuit of Figure 1				V		
	AMC2576-5.0		3.234	3.300	3.366			
Output Voltage (Note 1)	AMC2576-3.3	V_{OUT} Test circuit of Figure 1	$0.5A \leq I_{LOAD} \leq 3A$ $6V \leq V_{IN} \leq 40V$	3.168	3.300	3.432	V	
	AMC2576-5.0		$8V \leq V_{IN} \leq 40V$	4.800	5.000	5.200		
Output Voltage (Note 1)	AMC2576-3.3	V_{OUT} Test circuit of Figure 1	$0.5A \leq I_{LOAD} \leq 3A$, $-40^\circ C \leq T_J \leq 125^\circ C$ $6V \leq V_{IN} \leq 40V$	3.135	3.300	3.482	V	
	AMC2576-5.0		$8V \leq V_{IN} \leq 40V$	4.750	5.000	5.250		
Feedback Voltage (Note 1)	AMC2576-ADJ	V_{OUTFB} Test circuit of Figure 2	$V_{OUT} = 5V$	1.217	1.230	1.243	V	
Feedback Voltage (Note 1)	AMC2576-ADJ	V_{OUTFB} Test circuit of Figure 2	$8V \leq V_{IN} \leq 40V$, $V_{OUT} = 5V$, $0.5A \leq I_{LOAD} \leq 3A$	1.193	1.230	1.267	V	
Feedback Voltage (Note 1)	AMC2576-ADJ	V_{OUTFB} Test circuit of Figure 2	$8V \leq V_{IN} \leq 40V$, $V_{OUT} = 5V$, $0.5A \leq I_{LOAD} \leq 3A$, $-40^\circ C \leq T_J \leq 125^\circ C$	1.180	1.230	1.286	V	
Efficiency	AMC2576-3.3		$I_{LOAD} = 3A$		75		%	
	AMC2576-5.0				77			
	AMC2576-ADJ			$I_{LOAD} = 3A$, $V_{OUT} = 5V$		77		
Oscillator Frequency	f_{OSC}	(Note 2)	$T_J = 25^\circ C$	47	52	58	kHz	
			$-40^\circ C \leq T_J \leq 125^\circ C$	42	52	63		
Quiescent Current	I_Q	(Note 3)			5	10	mA	
Standby Current	I_{STBY}	$\overline{ENABLE} = 5V$				70	200	μA
Saturation Voltage	V_{SAT}	$I_{LOAD} = 3A$ (Note 4)	$T_J = 25^\circ C$		1.4	1.8	V	
			$-40^\circ C \leq T_J \leq 125^\circ C$			2.0		
Feedback Bias Current	I_{FB}	$V_{OUT} = 5V$ (ADJ version only)	$T_J = 25^\circ C$		50	100	nA	
			$-40^\circ C \leq T_J \leq 125^\circ C$			500		
Duty Cycle (ON)	DC	(Note 5)		93	98		%	
Current Limit	I_{LIMIT}	(Note 2, 4)	$T_J = 25^\circ C$	4.2	7	8.8	A	
			$-40^\circ C \leq T_J \leq 125^\circ C$	3.5	7.2	9		
Output Leakage Current	I_{LEAK}	(Note 3)	$V_{OUT} = 0V$		0.3	2	mA	
			$V_{OUT} = -1V$		9	20		
ENABLE Threshold Voltage	V_{IH}	$V_{OUT} = 0V$	$T_J = 25^\circ C$	2.2	1.4		V	
			$-40^\circ C \leq T_J \leq 125^\circ C$	2.4				
	V_{IL}	$V_{OUT} = \text{Normal Output Voltage}$	$T_J = 25^\circ C$		1.2	1.0		
			$-40^\circ C \leq T_J \leq 125^\circ C$			0.8		
ENABLE Input Current	I_{IH}	$\overline{ENABLE} = 5V$				12	30	μA
	I_{IL}	$\overline{ENABLE} = 0V$				0	10	

- Note 1: External components such as the catch diode, inductor, input and output capacitors can affect switching regulator system performance. Refer to Application Information for details.
- Note 2: The oscillator frequency reduces to approximately 11kHz in the event of fault conditions, such as output short or overload. And the regulated output voltage will drop approximately 40% from the nominal output voltage. This self-protection feature lowers the average power dissipation by lowering the minimum duty cycle from 5% down to approximately 2%.
- Note 3: For these parameters, FB is removed from V_{OUT} and connected to +12V to force the output transistor OFF.
- Note 4: V_{OUT} pin sourcing current. No diode, inductor or capacitor connect to V_{OUT} .
- Note 5: FB is removed from V_{OUT} and connected to 0V.

CHARACTERIZATION CURVES

Test circuits of Figure 1 and 2, $T_J=25^\circ\text{C}$, unless otherwise specified.

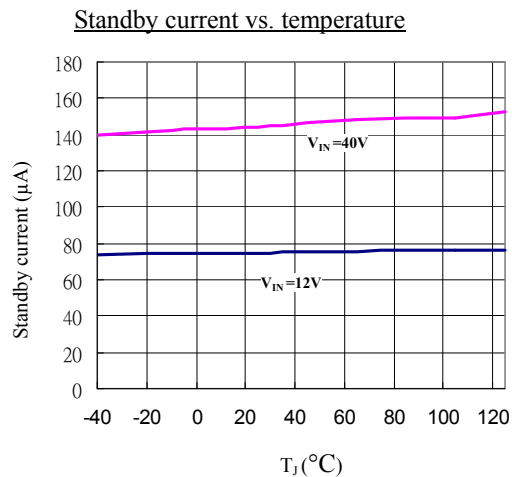
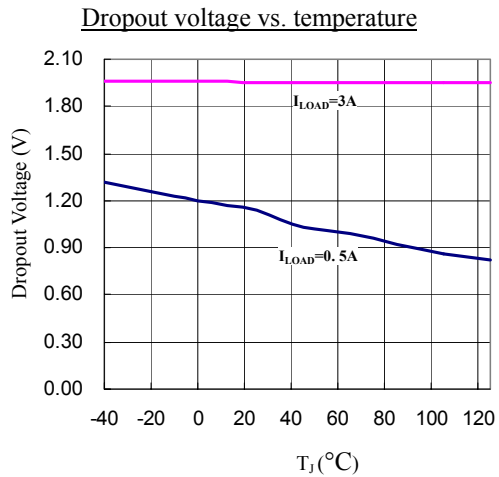
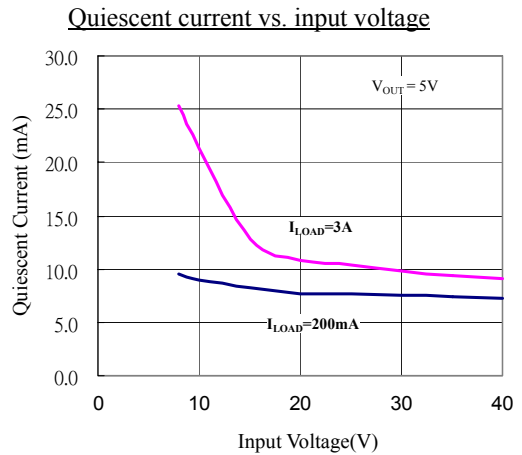
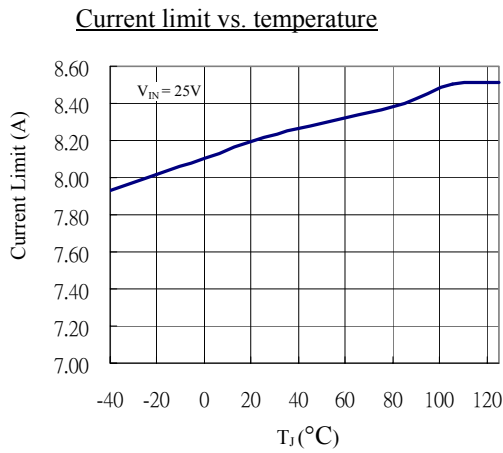
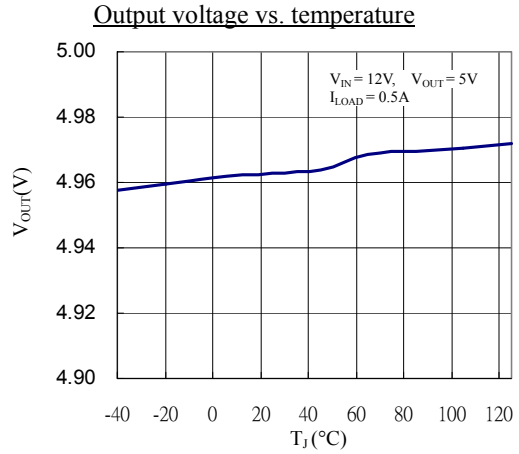
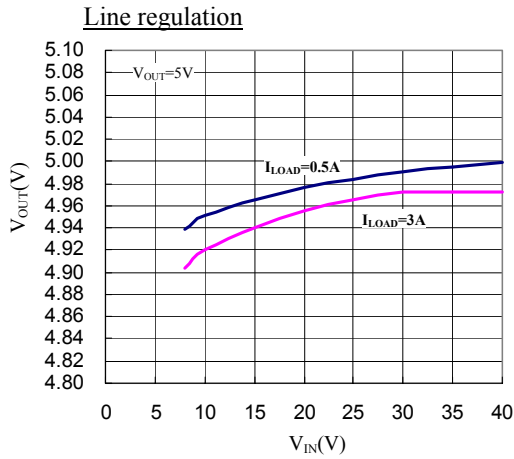

CHARACTERIZATION CURVES (continued)

Test circuits of Figure 1 and 2, $T_J=25^{\circ}\text{C}$, unless otherwise specified.

Saturation voltage vs. load current

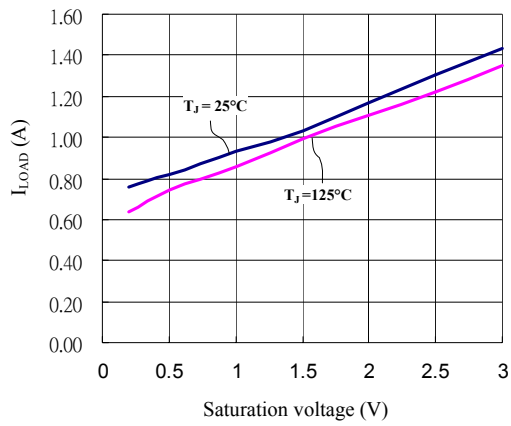

Load transient response

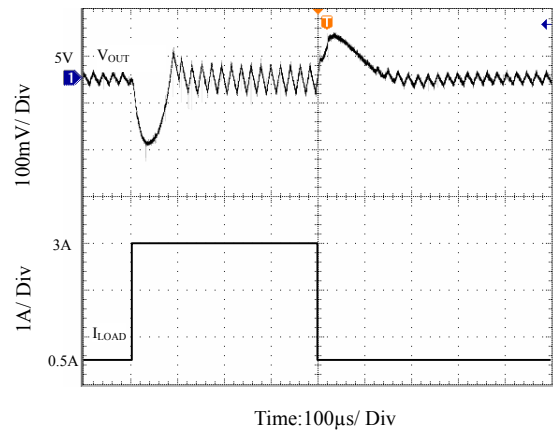

Application Information

Input Capacitors (C_{IN})

It is required that V_{IN} must be bypassed with at least a 100 μ F electrolytic capacitor for stability. Also, it is strongly recommended the capacitor's leads must be kept short, and located near the regulator as possible.

For low operating temperature range, for example, below -25°C, the input capacitor value may need to be larger. This is due to the reason that the capacitance value of electrolytic capacitors decreases and the ESR increases with lower temperatures and age. Paralleling a ceramic or solid tantalum capacitor will increase the regulator stability at cold temperatures.

Output Capacitors (C_{OUT})

An output capacitor is also required to filter the output voltage and is needed for loop stability. The capacitor should be located near the AMC2576 using short PC board traces. Low ESR types capacitors are recommended for low output ripple voltage and good stability. Generally, low value or low voltage (less than 12V) electrolytic capacitors usually have higher ESR numbers. For example, the lower capacitor values (220 μ F–1000 μ F) will yield typically 50 mV to 150 mV of output ripple voltage, while larger-value capacitors will reduce the ripple to approximately 20 mV to 50 mV.

The amount of output ripple voltage is primarily a function of the ESR (Equivalent Series Resistance) of the output capacitor and the amplitude of the inductor ripple current (ΔI_{IND}).

$$\text{Output Ripple Voltage} = (\Delta I_{IND}) \times (\text{ESR of } C_{OUT})$$

Some capacitors called “high-frequency,” “low-inductance,” or “low-ESR.” are recommended to use to further reduce the output ripple voltage to 10 mV or 20 mV. However, very low ESR capacitors, such as Tantalum capacitors, should be carefully evaluated.

Catch Diode

This diode is required to provide a return path for the inductor current when the switch is off. It should be located close to the AMC2576 using short leads and short printed circuit traces as possible.

To satisfy the need of fast switching speed and low forward voltage drop, Schottky diodes are widely used to provide the best efficiency, especially in low output voltage switching regulators (less than 5V). Besides, fast-Recovery, high-efficiency, or ultra-fast recovery diodes are also suitable. But some types with an abrupt turn-off characteristic may cause instability and EMI problems. A fast-recovery diode with soft recovery characteristics is a better choice.

Application Information (contd.)

Output Voltage Ripple and Transients

The output ripple voltage is due mainly to the inductor sawtooth ripple current multiplied by the ESR of the output capacitor.

The output voltage of a switching power supply will contain a sawtooth ripple voltage at the switcher frequency, typically about 1% of the output voltage, and may also contain short voltage spikes at the peaks of the sawtooth waveform.

Due to the fast switching action, and the parasitic inductance of the output filter capacitor, there is voltage spikes presenting at the peaks of the sawtooth waveform. Cautions must be taken for stray capacitance, wiring inductance, and even the scope probes used for transients evaluation. To minimize these voltage spikes, shortening the lead length and PCB traces is always the first thought. Further more, an additional small LC filter (20 μ H & 100 μ F) (as shown in Figure 3) will possibly provide a 10X reduction in output ripple voltage and transients.

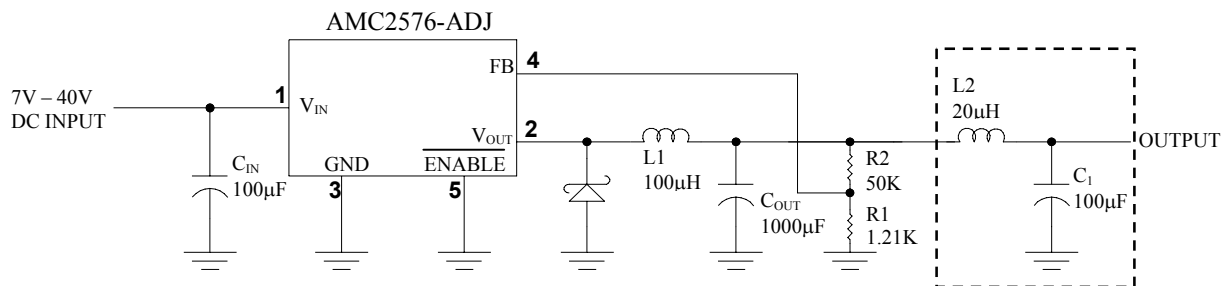

Figure 3. LC Filter for Low Output Ripple

Inductor Selection

The AMC2576 can be used for either continuous or discontinuous modes of operation. Each mode has distinctively different operating characteristics, which can affect the regulator performance and requirements.

With relatively heavy load currents, the circuit operates in the continuous mode (inductor current always flowing), but under light load conditions, the circuit will be forced to the discontinuous mode (inductor current falls to zero for a period of time). For light loads (less than approximately 300 mA) it may be desirable to operate the regulator in the discontinuous mode, primarily because of the lower inductor values required for the discontinuous mode.

Inductors are available in different styles such as pot core, toroid, E-frame, bobbin core, et., as well as different core materials, such as ferrites and powdered iron. The least expensive, the bobbin core type, consists of wire wrapped on a ferrite rod core. This type of construction makes for an inexpensive inductor, but since the magnetic flux is not completely contained within the core, it generates more electromagnetic interference (EMI). This EMI can cause problems in sensitive circuits, or can give incorrect scope readings because of induced voltages in the scope probe.

An inductor should not be operated beyond its maximum rated current because it may saturate. When an inductor begins to saturate, the inductance decreases rapidly and the inductor begins to look mainly resistive (the DC resistance of the winding). This will cause the switch current to rise very rapidly. Different inductor types have different saturation characteristics, and this should be well considered when selecting an inductor.

Application Information (contd.)

Feedback Connection

For fixed output voltage version, the FB (feedback) pin must be connected to V_{OUT} . For the adjustable version, it is important to place the output voltage ratio resistors near AMC2576 as possible in order to minimize the noise introduction.

ENABLE

It is required that the \overline{ENABLE} must **not** be left open. For normal operation, connect this pin to a “LOW” voltage (typically, below 1.6V). On the other hand, for standby mode, connect this pin with a “HIGH” voltage. This pin can be safely pulled up to $+V_{IN}$ without a resistor in series with it.

Grounding

To maintain output voltage stability, the power ground connections must be low-impedance. For the 5-lead TO-220 and TO-263 style package, both the tab and pin 3 are ground and either connection may be used.

Heat Sink and Thermal Consideration

Although the AMC2576 requires only a small heat sink for most cases, the following thermal consideration is important for all operation. With the package thermal resistances θ_{JA} and θ_{JC} , total power dissipation can be estimated as follows:

$$P_D = (V_{IN} \times I_Q) + (V_{OUT} / V_{IN})(I_{LOAD} \times V_{SAT});$$

When no heat sink is used, the junction temperature rise can be determined by the following:

$$\Delta T_J = P_D \times \theta_{JA};$$

With the ambient temperature, the actual junction temperature will be:

$$T_J = \Delta T_J + T_A ;$$

If the actual operating junction temperature is out of the safe operating junction temperature (typically 125°C), then a heat sink is required. When using a heat sink, the junction temperature rise will be reduced by the following:

$$\Delta T_J = P_D \times (\theta_{JC} + \theta_{interface} + \theta_{Heat\ sink});$$

As one can see from the above, it is important to choose an heat sink with adequate size and thermal resistance, such that to maintain the regulator's junction temperature below the maximum operating temperature.

3A STEP-DOWN VOLTAGE REGULATOR

5-Pin Plastic TO-220 (P)

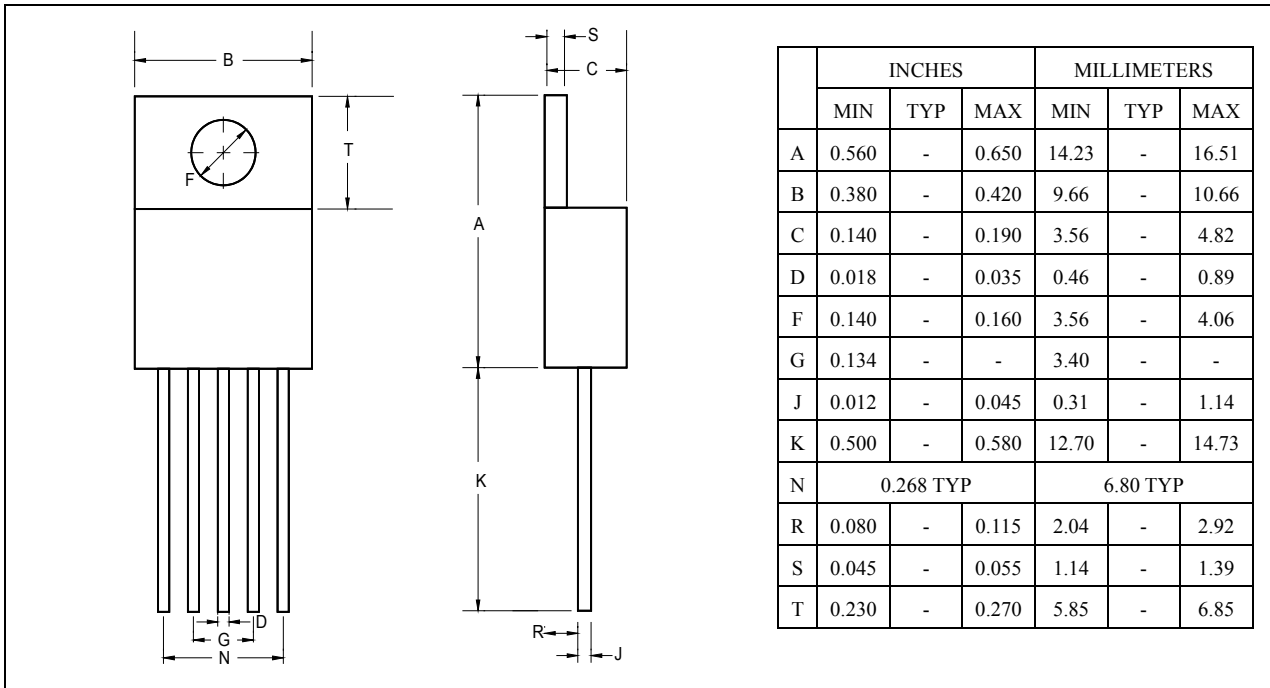

5-Pin Surface Mount TO-263 (DD)

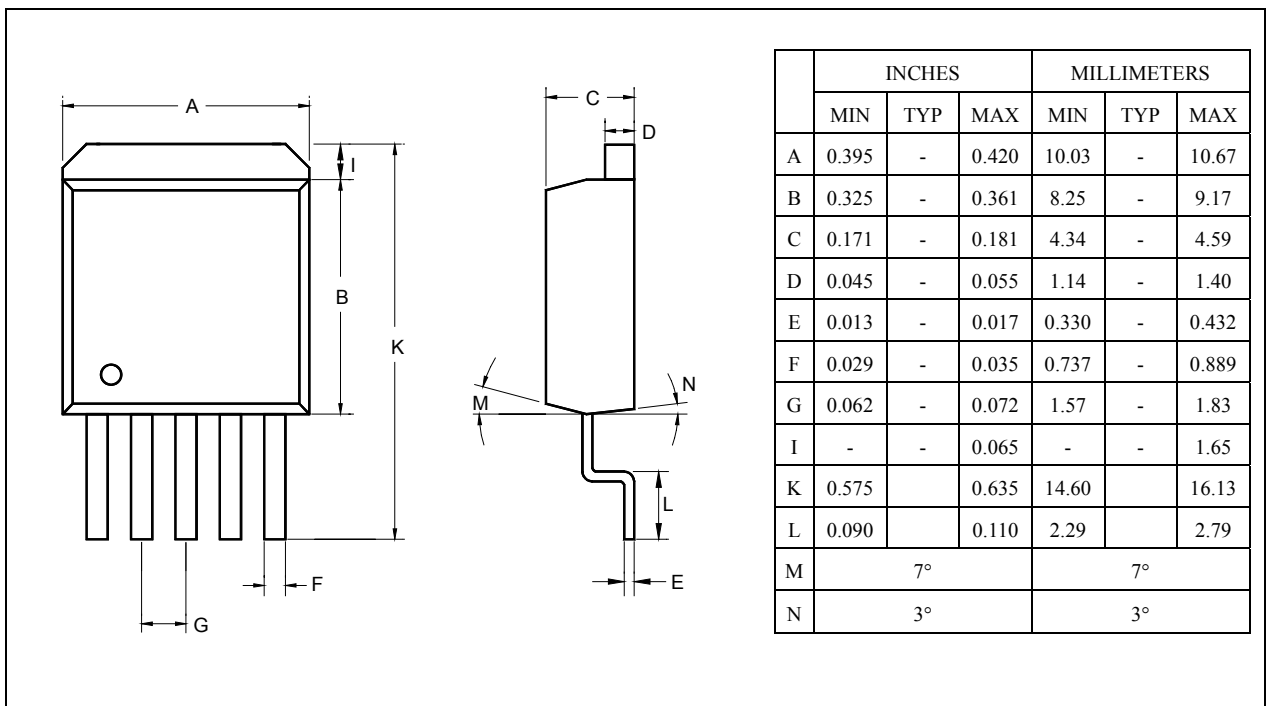

3A STEP-DOWN VOLTAGE REGULATOR

5-Pin Plastic TO-220B (PB)

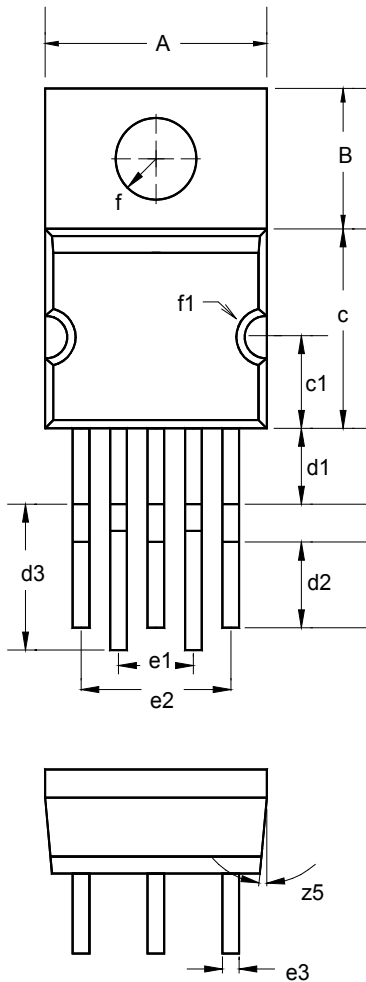

	INCHES			MILLIMETERS		
	MIN	TYP	MAX	MIN	TYP	MAX
A	0.380	0.401	0.420	9.65	10.20	10.65
B		0.248			6.30	
c	0.348	0.358	0.368	8.85	9.10	9.35
c1		0.167			4.25	
d1		0.138			3.50	
d2		0.154			3.90	
d3		0.213			5.40	
e1		0.134			3.40	
e2		0.268			6.80	
e3		0.032			0.81	
f		0.151			3.84	
f1		0.039			1.00	
G	0.048	0.05	0.052	1.22	1.27	1.32
H		0.996			25.30	
I	0.175	0.180	0.185	4.44	4.57	4.70
J		0.965			24.50	
K		0.105			2.67	
L	0.164	0.173	0.182	4.17	4.40	4.63
M		0.05			1.27	
N	0.013	0.015	0.025	0.33	0.381	0.63
O	0.322	0.331	0.340	8.17	8.40	8.63
z1		7°			7°	
z2		7°			7°	
z3		7°			7°	
z4		5°			5°	
Z5		5°			5°	

IMPORTANT NOTICE

ADD Microtech (ADDM) reserves the right to make changes to its products or to discontinue any integrated circuit product or service without notice, and advises its customers to obtain the latest version of relevant information to verify, before placing orders, that the information being relied on is current.

A few applications using integrated circuit products may involve potential risks of death, personal injury, or severe property or environmental damage. ADDM integrated circuit products are not designed, intended, authorized, or warranted to be suitable for use in life-support applications, devices or systems or other critical applications. Use of ADDM products in such applications is understood to be fully at the risk of the customer. In order to minimize risks associated with the customer's applications, the customer should provide adequate design and operating safeguards.

ADDM assumes to no liability to customer product design or application support. ADDM warrants the performance of its products to the specifications applicable at the time of sale.

U.S.

ADD Microtech Inc.
492 Altamont Drive
Milpitas, CA 95035

TEL : (408) 9410420
FAX : (408) 9410864

Asia Pacific region

ADD Microtech Corp
13F, 287, Sec. 3, Nan Jin E. Rd.,
Taipei, Taiwan

TEL : 2-27132800
FAX : 2-27132805