

AMC DOC. #:AMC8878_A (LF)
Jun 2004



AMC8877

LOW NOISE 300mA LOW DROP OUT REGULATOR

DESCRIPTION	FEATURES
<p>The AMC8877 product is a low noise, low dropout linear regulator operating from 2.5V to 6.5V input. An external capacitor can be connected to the bypass pin to lower the output noise level to $30\mu\text{V}_{\text{RMS}}$.</p> <p>Designed with a P-channel MOSFET output transistor, the AMC8877 consume a low supply current, independent of the load current and dropout voltage. The internal thermal shut down circuit will limits the junction temperature to below 150°C. Other features include thermal protection, reverse battery protection and output current limit. The AMC8877 come in a miniature 5-pin SOT-23 package.</p>	<ul style="list-style-type: none"> ■ Low output noise: $30\mu\text{V}_{\text{RMS}}$ ■ Industry standard'2982 pin assignment (AMC8877) ■ Output voltage precision of $\pm 1.4\%$ accuracy ■ Very low dropout voltage: $50\text{mV}/50\text{mA}$, $165\text{mV}/150\text{mA}$ & $450\text{mV}/300\text{mA}$ ■ On/Off control ■ Low I_{Q}: $1.6\mu\text{A}$ ■ Short circuit protection ■ Internal thermal overload protection ■ Available in surface mount 5-pin SOT-23 package. ■ Enhanced pin-to-pin Compatible to the MAX8878 (AMC8877).

APPLICATIONS	PACKAGE PIN OUT
<ul style="list-style-type: none"> ◆ Cellular Telephones ◆ Battery Powered Systems ◆ Hand-Held Instruments ◆ Pagers ◆ Personal Data Assistance (PDA) ◆ PCMCIA Cards 	<p>AMC8877</p> <p>5-Pin Plastic SOT-23 Surface Mount (Top View)</p>

ORDER INFORMATION		
Temperature Range	DBT	Plastic SOT-23 5-pin
$0^{\circ}\text{C} \leq T_{\text{A}} \leq 70^{\circ}\text{C}$	AMC8877-X.XDBT	
$0^{\circ}\text{C} \leq T_{\text{A}} \leq 70^{\circ}\text{C}$	AMC8877-X.XDBTF(Lead Free)	

EXPANDED ORDER INFORMATION		
Device Name	Output Voltage	Symbolization
		AMC8877
AMC887□-1.8DBT	1.8V	CG18
AMC887□-2.0DBT	2.0V	CG20
AMC887□-2.5DBT	2.5V	CG25
AMC887□-2.8DBT	2.8V	CG28
AMC887□-2.85DBT	2.85V	CG2U
AMC887□-3.0DBT	3.0V	CG30
AMC887□-3.2DBT	3.2V	CG32
AMC887□-3.3DBT	3.3V	CG33
AMC887□-5.0DBT	5.0V	CG50

TYPICAL APPLICATION

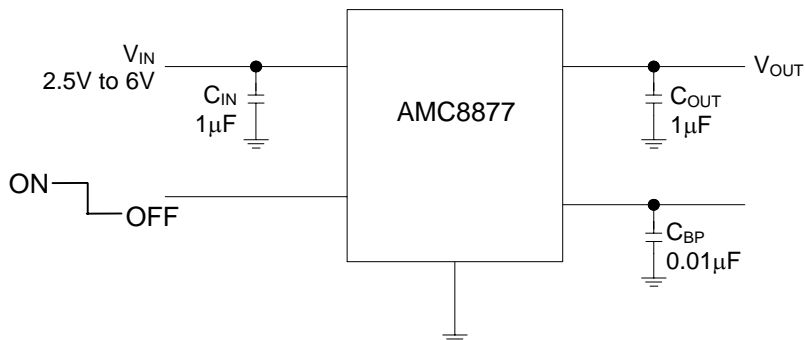

ABSOLUTE MAXIMUM RATINGS (Note)

Input Voltage, V_{IN}	12V
Operating Junction Temperature, T_J	150 °C
Storage Temperature Range	-65 °C to +150 °C
Lead Temperature (soldering, 10 seconds)	+260 °C
Power Dissipation, P_D @ $T_A = 70$ °C	150 mW
Note: Exceeding these ratings could cause damage to the device. All voltages are with respect to Ground. Currents are positive into, negative out of the specified terminal.	

THERMAL DATA

DB PACKAGE:

Thermal Resistance from Junction to Ambient, θ_{JA}	220 °C /W
--	-----------

Junction Temperature Calculation: $T_J = T_A + (P_D \times \theta_{JA})$.
 The θ_{JA} numbers are guidelines for the thermal performance of the device/pc-board system.
 Connect the ground pin to ground using a large pad or ground plane for better heat dissipation.
 All of the above assume no ambient airflow.

Maximum Power Calculation:

$$P_{D(MAX)} = \frac{T_{J(MAX)} - T_{A(MAX)}}{\theta_{JA}}$$

T_J (°C): Maximum recommended junction temperature

T_A (°C): Ambient temperature of the application

θ_{JA} (°C /W): Junction-to-junction temperature thermal resistance of the package, and other heat dissipating materials.

The maximum power dissipation for a single-output regulator is :

$$P_{D(MAX)} = [(V_{IN(MAX)} - V_{OUT(NOM)}) \times I_{OUT(NOM)} + V_{IN(MAX)} \times I_Q]$$

Where: $V_{OUT(NOM)}$ = the nominal output voltage

$I_{OUT(NOM)}$ = the nominal output current, and

I_Q = the quiescent current the regulator consumes at $I_{OUT(MAX)}$

$V_{IN(MAX)}$ = the maximum input voltage

Then $\theta_{JA} = (+150 \text{ °C} - T_A) / P_D$

AMC8877
Low Noise 300mA
Low Dropout Regulator

BLOCK DIAGRAM

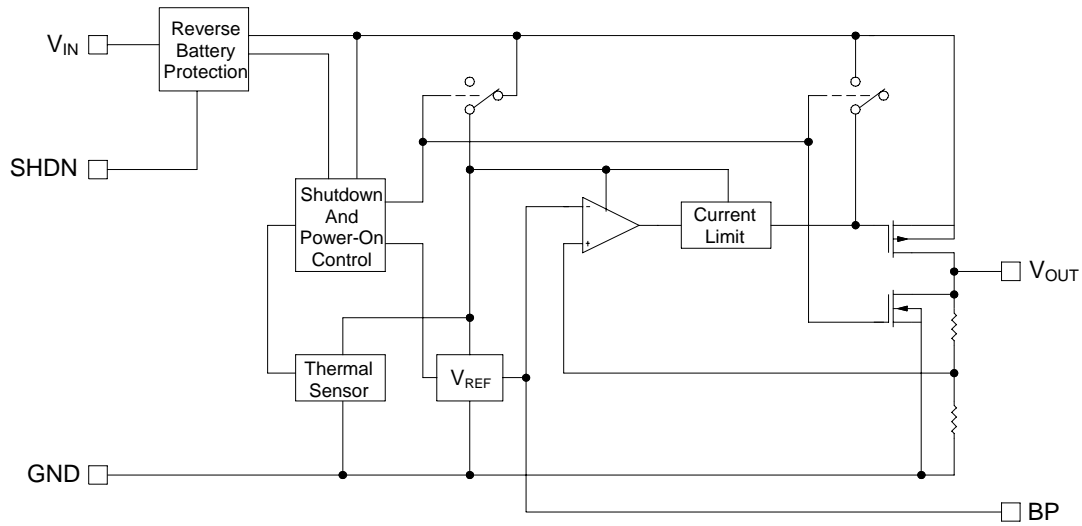

PIN DESCRIPTION			
Pin Number		Pin Name	Pin Function
AMC8878	AMC8879		
1	5	V_{IN}	Input
2	2	GND	Ground
3	1	\overline{SHDN}	Logic control shutdown pin; HI: Device is ON, LO: Device is OFF
4	3	BP	Noise bypass pin; The output noise level can be reduced to $30\mu V_{RMS}$ by connecting external capacitors
5	4	V_{OUT}	Output

AMC8877
Low NOISE 300mA
Low DROPOUT REGULATOR

RECOMMENDED OPERATING CONDITIONS

Parameter	Symbol	Recommended Operating Conditions			Units
		Min.	Typ.	Max.	
Input Voltage	V_{IN}	2.5		6.5	V
Load Current	I_o	5		300	mA
Input Capacitor (V_{IN} to GND)		1.0			μ F
Output Capacitor with ESR of 10 Ω max., (V_{OUT} to GND)		1.0			μ F

Note:

1. C_{IN} : A 1.0 μ F capacitor (or larger) should be placed between V_{IN} to GND.
2. C_{OUT} : A 1.0 μ F (or larger) capacitor is recommended between V_{OUT} and GND for stability and improving the regulator's transient response. The ESR (Effective Series Resistance.) of this capacitor has no effect on regulator stability, but low ESR capacitors improve high frequency transient response. The value of this capacitor may be increased without limit, but values larger than 10 μ F tend to increase the settling time after a step change in input voltage or output current. The part may oscillate without the capacitor. Any type of capacitor can be used, but not Aluminum electrolytics when operating below -25 $^{\circ}$ C. The capacitance may be increased without limit.

ELECTRICAL CHARACTERISTICS

Unless otherwise specified, these specifications apply over the operating ambient temperature of 0 $^{\circ}$ C to +70 $^{\circ}$ C with $V_{IN} = V_{OUT(NOMIAL)} + 0.5V$, and are for DC characteristics only. (Low duty cycle pulse testing techniques are used which maintains junction and case temperatures equal to the ambient temperature.)

Parameter	Symbol	Test Conditions	AMC8877			Units	
			Min	Typ.	Max		
Output Voltage Accuracy	ΔV_{OUT}	$I_{OUT} = 10mA, T_A = +25^{\circ}C$	-1.4		+1.4	%	
		$I_{OUT} = 10$ to 300mA	-3		+2		
Maximum Output Current	I_{OUT}			300		mA	
Current Limit	I_{LIMIT}		330			mA	
Ground Pin Current	I_Q	$I_{OUT} = 10mA$		1.6	9	μ A	
		$I_{OUT} = 300mA$		1.7	9		
Dropout Voltage	V_{DROP}	$I_{OUT} = 50mA$		50	120	mV	
		$I_{OUT} = 150mA$		165	300		
		$I_{OUT} = 300mA$		450	650		
Line Regulation	ΔV_{OI}	$V_{IN} = (V_{OUT} + 0.1V)$ to 6.5V, $I_{OUT} = 1mA$	-0.15	0	0.15	%/V	
Load Regulation	ΔV_{OL}	$I_{OUT} = 10$ to 300mA, $C_{OUT} = 10\mu F$		40	80	mV	
Ripple Rejection	PSRR	$f=100Hz, I_L=100uA$		50		dB	
Output Voltage Noise	e_n	$f = 10Hz - 100KHz,$ $C_{BP} = 0.01\mu F$	$C_{OUT} = 10\mu F$		30	μV_{RMS}	
			$C_{OUT} = 100\mu F$		20		
Shutdown Input Threshold High	V_{SIH}	$V_{IN} = 2.5V$ to 5.5V	2.0			V	
Shutdown Input Threshold Low	V_{SIL}	$V_{IN} = 2.5V$ to 5.5V			0.4	V	
Shutdown Supply Current	$I_{Q(SHDN)}$	$V_{OUT} = 0V$	$T_A = +25^{\circ}C$		0.01	1	μ A
			$T_A = +85^{\circ}C$		0.2		
Shutdown Input Bias Current	I_{SHDN}	$V_{SHDN} = V_{IN}$	$T_A = +25^{\circ}C$		0.01	100	nA
			$T_A = +85^{\circ}C$		0.5		
Shutdown Exit Delay	t_{delay}	$C_{BP} = 0.1\mu F,$ $C_{OUT} = 1\mu F, No load$	$T_A = +25^{\circ}C$		6	ms	
			$T_A = +85^{\circ}C$		6		
Thermal Shutdown Temperature	T_{SHDN}			+150		$^{\circ}$ C	

Note:

1. Current limit is measured at constant junction temperature, using pulse ON time.
2. Dropout is measured at constant junction temperature, using pulse ON time, and criterion is V_{OUT} inside target value $\pm 2\%$.
3. Regulation is measured at constant junction temperature, using pulsed ON time.

Characterization Curves

$V_{IN} = V_{OUT(NOMINAL)} + 0.5V$ or $2.5V$ (whichever is greater), $C_{IN} = 1\mu F$, $C_{OUT} = 1\mu F$, $C_{BP} = 0.01\mu F$, $T_A = +25^\circ C$, Using plused ON time, unless otherwise noted.

Output Voltage v.s. Output Current

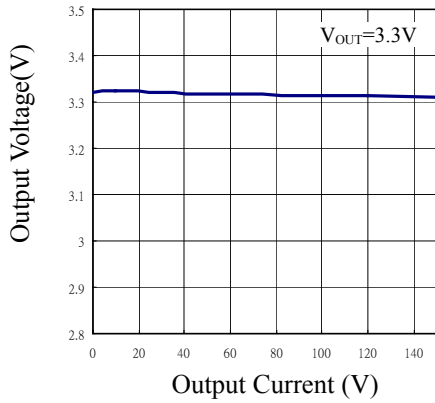

Quiescent Current v.s. Output Current

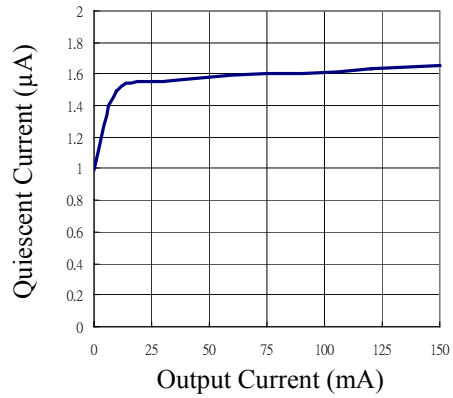

Output Voltage v.s. Input Voltage

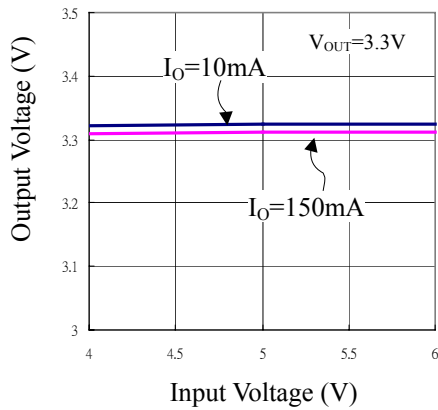

Quiescent Current v.s. Input Voltage

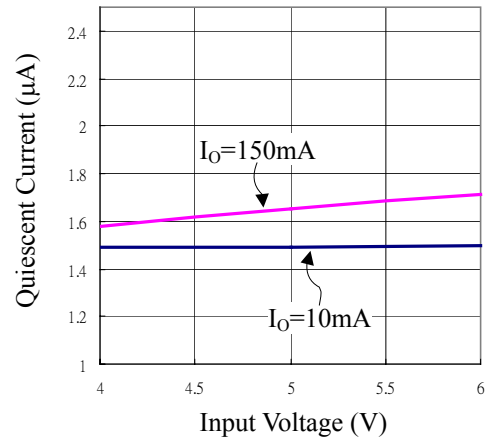

Output Voltage v.s. Temperature

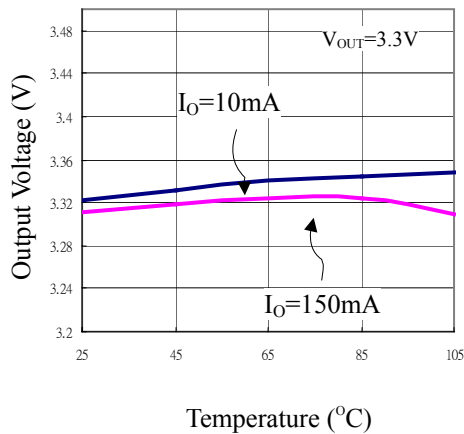

Quiescent Current v.s. Temperature

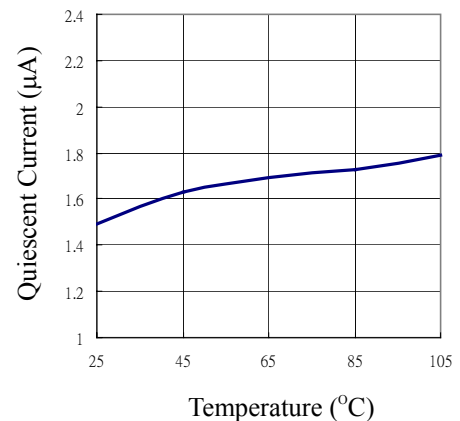

Characterization Curves (Continued)

$V_{IN}=V_{OUT(NOMINAL)} + 0.5V$ or $2.5V$ (whichever is greater), $C_{IN}=1\mu F$, $C_{OUT}=1\mu F$, $C_{BP}=0.01\mu F$, $T_A=+25^\circ C$, Using plused ON time, unless otherwise noted.

Dropout Voltage v.s. Output Current

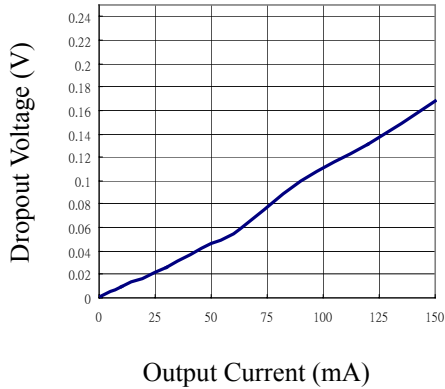

Dropout Voltage v.s. Temperature

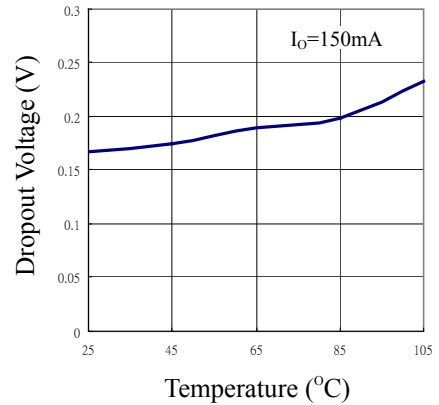

Load Transient Response with I_O=50mA

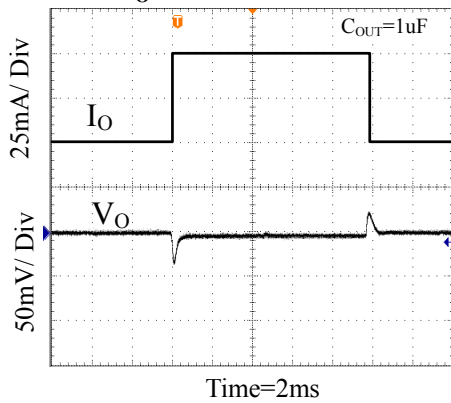

Load Transient Response with I_O=150mA

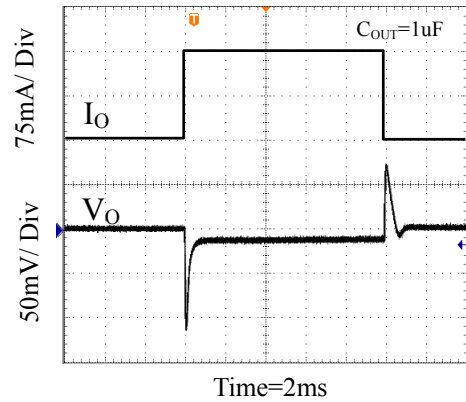

I_{LOAD} = 300mA V_{IN} = 3V

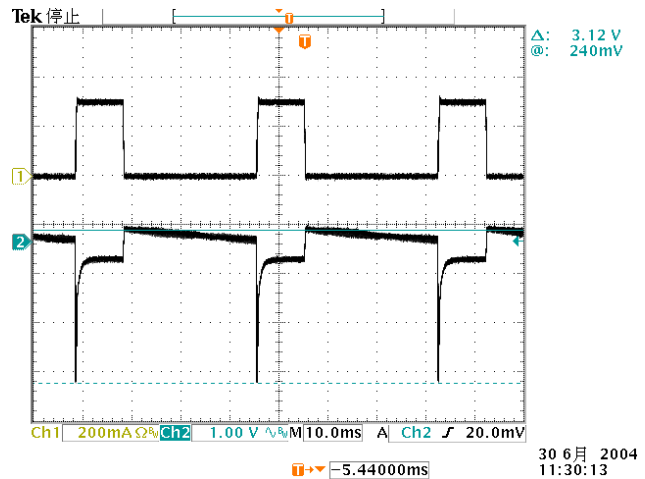
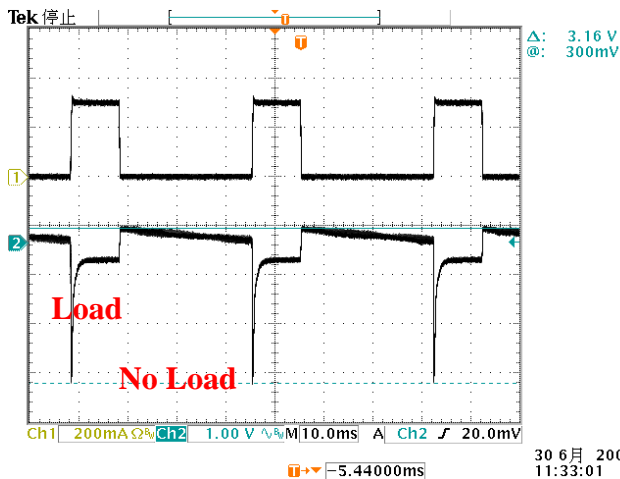

AMC8877

LOW NOISE 300mA LOW DROPOUT REGULATOR

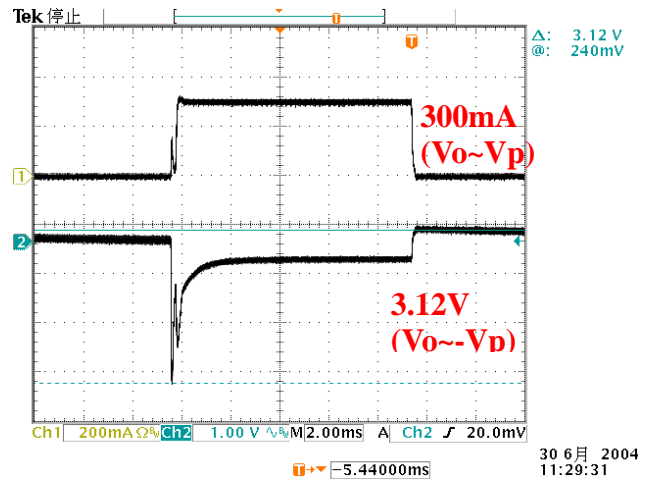
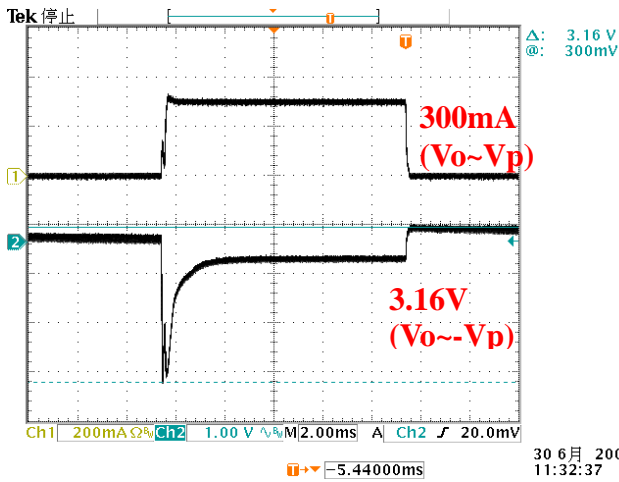

**Line Transient Response,
 With $I_O=50mA$**

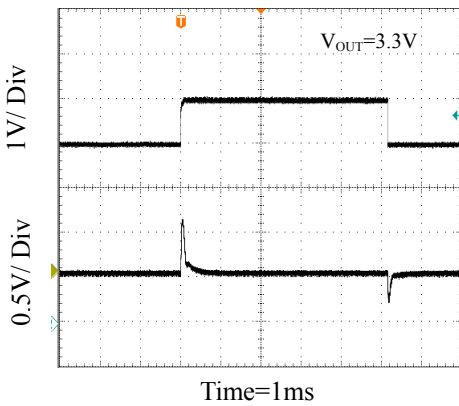

**Entering Shutdown,
 No Load**

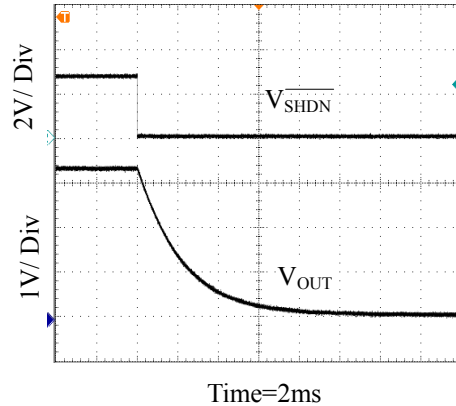

**Shutdown Exit Delay,
 $C_{BP}=0.1\mu F$**

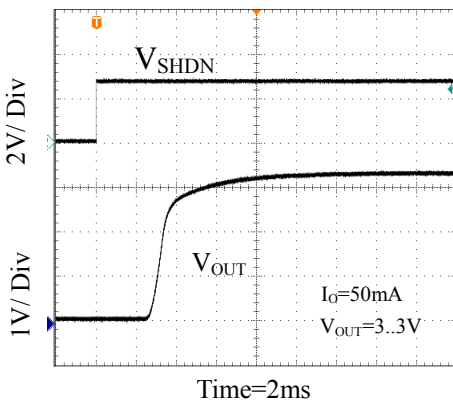

**Shutdown Exit Delay,
 $C_{BP}=2pF$**

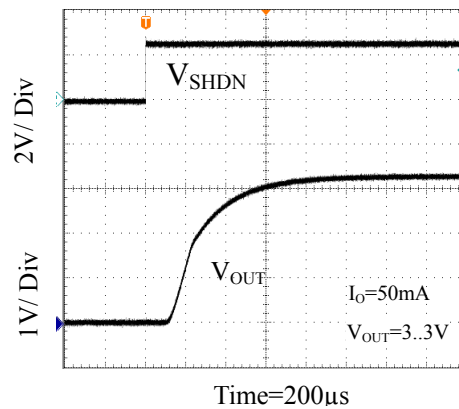

AMC8877
Low NOISE 300mA
Low DROP OUT REGULATOR

5-Pin SOT-23

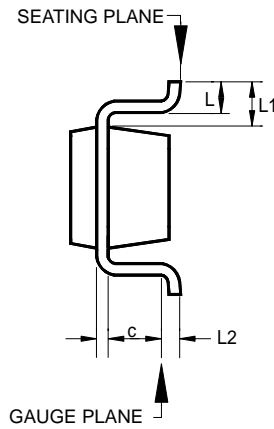
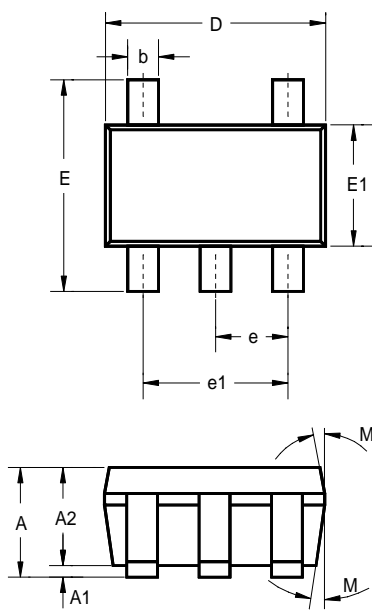

	INCHES			MILLIMETERS		
	MIN	TYP	MAX	MIN	TYP	MAX
A	-	-	0.057	-	-	1.45
A1	-	-	0.006	-	-	0.15
A2	0.035	0.045	0.051	0.90	1.15	1.30
b	0.012	-	0.020	0.30	-	0.50
c	0.003	-	0.009	0.08	-	0.22
D	0.114 BSC			2.90 BSC		
E	0.110 BSC			2.80 BSC		
E1	0.063 BSC			1.60 BSC		
e	0.037 BSC			0.95 BSC		
e1	0.075 BSC			1.90 BSC		
L	0.012	0.018	0.024	0.30	0.45	0.60
L1	0.024 REF			0.60 REF		
L2	0.010 BSC			0.25 BSC		
°M	5°	10°	15°	5°	10°	15°

IMPORTANT NOTICE

ADD Microtech (ADDM) reserves the right to make changes to its products or to discontinue any integrated circuit product or service without notice, and advises its customers to obtain the latest version of relevant information to verify, before placing orders, that the information being relied on is current.

A few applications using integrated circuit products may involve potential risks of death, personal injury, or severe property or environmental damage. ADDM integrated circuit products are not designed, intended, authorized, or warranted to be suitable for use in life-support applications, devices or systems or other critical applications. Use of ADDM products in such applications is understood to be fully at the risk of the customer. In order to minimize risks associated with the customer's applications, the customer should provide adequate design and operating safeguards.

ADDM assumes no liability to customer product design or application support. ADDM warrants the performance of its products to the specifications applicable at the time of sale.

U.S.

ADD Microtech Inc.
492 Altamont Drive
Milpitas, CA 95035

TEL: (408) 9410420
FAX: (408) 9410864

Asia Pacific region

ADD Microtech Corp
13F, NO. 287, Sec. 3, Nan Jing E. Rd.,
Taipei, Taiwan 105

TEL: 2-27132800
FAX: 2-27132805