

■ General Description

The AME8855 family of positive, CMOS linear regulators provide low dropout voltage(420mV@600mA), low quiescent current, and low noise CMOS LDO. These rugged devices have both Thermal Shutdown, and Current limit to prevent device failure under the "Worst" of operating conditions.

■ Features

- Low Dropout Voltage: 420mV@600mA
- Guaranteed Current: 600mA
- Quiescent Current: 60μA (typ.)
- Over-Temperature Shutdown
- Current Limiting protection
- PSRR:60dB@10KHz
- Ultra-Low-Noise: 100μV_{RMS} at 1Hz to 100KHz
- Low Temperature Coefficient
- Input Voltage Range 2.8V~5.5V
- Output Voltage Range: 0.8V ~ 4.3V
- Green Products Meet RoHS Standards

■ Applications

- Instrumentation
- Portable Electronics
- Wireless Devices
- Cordless Phones
- PC Peripherals
- Battery Powered Widgets

■ Typical Application

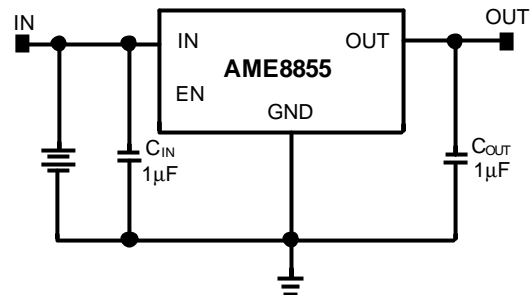

■ Functional Block Diagram

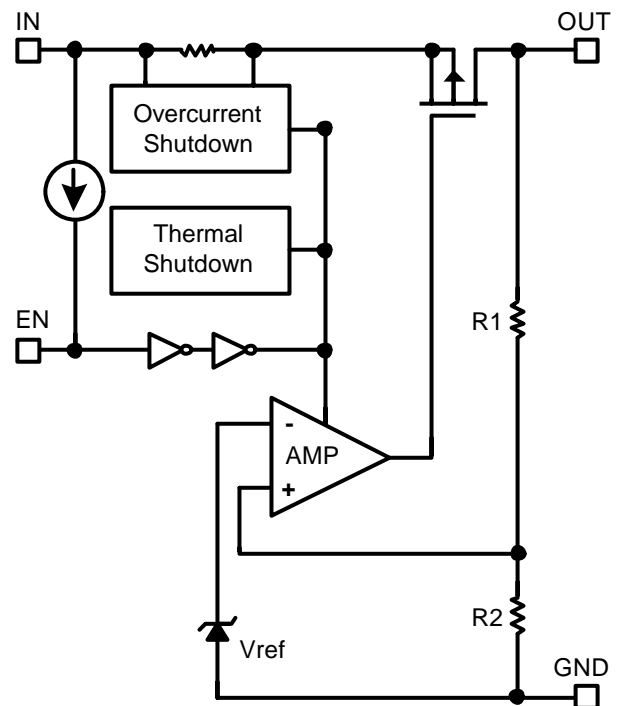

AME8855

■ Pin Configuration

3 Pin



AME8855-AGTxxx

1. IN
2. GND (TAB)
3. OUT

* **Die Attach:**
Conductive Epoxy



AME8855-BGTxxx

1. GND
2. OUT (TAB)
3. IN

* **Die Attach:**
Non-Conductive Epoxy



AME8855-AFTxxx

1. IN
2. GND (TAB)
3. OUT

* **Die Attach:**
Conductive Epoxy



AME8855-BFTxxx

1. GND
2. OUT (TAB)
3. IN

* **Die Attach:**
Non-Conductive Epoxy

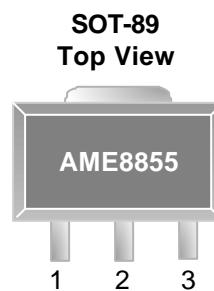

AME8855-CFTxxx

1. GND
2. IN (TAB)
3. OUT

* **Die Attach:**
Non-Conductive Epoxy

AME8855

■ Pin Configuration (Contd.)

3 Pin

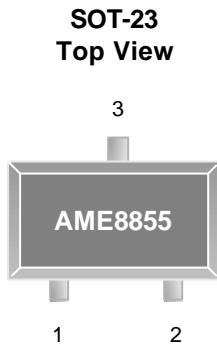

AME8855-AETxxx

1. IN
2. GND
3. OUT

* Die Attach:
Non-Conductive Epoxy

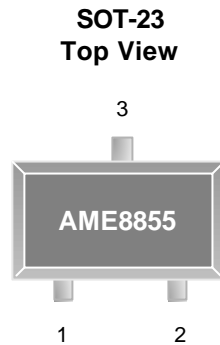

AME8855-BETxxx

1. GND
2. OUT
3. IN

* Die Attach:
Non-Conductive Epoxy

5 Pin

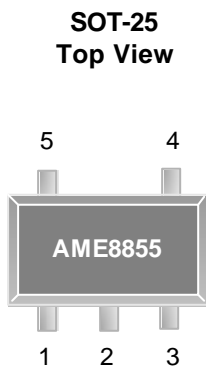

AME8855-AEVxxx

1. IN
2. GND
3. EN
4. NC
5. OUT

* Die Attach:
Conductive Epoxy

8 Pin

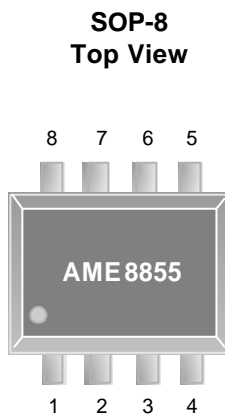

AME8855-AHAxxx

1. IN
2. GND
3. GND
4. OUT
5. NC
6. GND
7. GND
8. EN

* Die Attach:
Conductive Epoxy

AME8855
■ Pin Description
SOT-223

Pin Number		Pin Name	Pin Description
A	B		
1	3	IN	Input voltage pin; should be decoupled with 1 μ F or greater capacitor.
2	1	GND	Ground connection pin.
3	2	OUT	LDO voltage regulator output pin; should be decoupled with a 1.0 μ F or greater value low ESR ceramic capacitor.

SOT-89

Pin Number			Pin Name	Pin Description
A	B	C		
1	3	2	IN	Input voltage pin; should be decoupled with 1 μ F or greater capacitor.
2	1	1	GND	Ground connection pin.
3	2	3	OUT	LDO voltage regulator output pin; should be decoupled with a 1.0 μ F or greater value low ESR ceramic capacitor.

AME8855**■ Pin Configuration**

SOP-8

Pin Number	Pin Name	Pin Description
1	IN	Input voltage pin; should be decoupled with 1 μ F or greater capacitor.
2	GND	Ground connection pin.
3	GND	Ground connection pin.
4	OUT	LDO voltage regulator output pin; should be decoupled with a 1.0 μ F or greater value low ESR ceramic capacitor.
5	NC	No connection.
6	GND	Ground connection pin.
7	GND	Ground connection pin.
8	EN	Enable pin, Active "high". When pulled "low", the PMOS pass transistor turns off, current consuming less than 1 μ A. When EN pin floating outside, it's weakly pulled high from internal MOS.

AME8855
■ Pin Configuration
SOT-23

Pin Number		Pin Name	Pin Description
A	B		
1	3	IN	Input voltage pin; should be decoupled with 1 μ F or greater capacitor.
2	1	GND	Ground connection pin.
3	2	OUT	LDO voltage regulator output pin; should be decoupled with a 1.0 μ F or greater value low ESR ceramic capacitor.

SOT-25

Pin Number	Pin Name	Pin Description
1	IN	Input voltage pin; should be decoupled with 1 μ F or greater capacitor.
2	GND	Ground connection pin.
3	EN	Enable pin, Active "high". When pulled "low", the PMOS pass transistor turns off, current consuming less than 1 μ A. When EN pin floating outside, it' s weakly pulled high from internal MOS .
4	NC	No connection.
5	OUT	LDO voltage regulator output pin; should be decoupled with a 1.0 μ F or greater value low ESR ceramic capacitor.

AME8855

■ Ordering Information

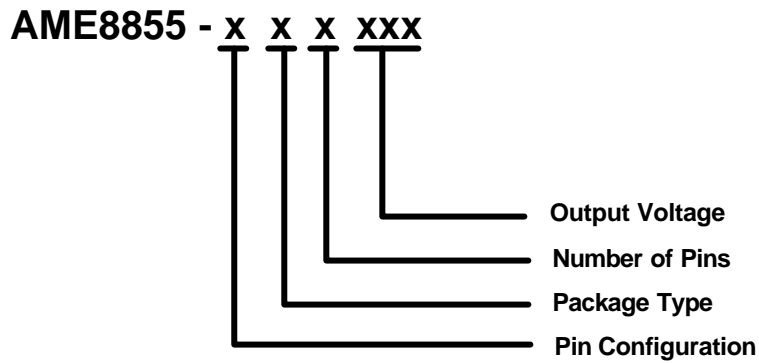

Pin Configuration	Package Type	Number of Pins	Output Voltage
A 1. IN <small>(SOT-223)</small> 2. GND <small>(SOT-23)</small> 3. OUT <small>(SOT-89)</small>	E: SOT-2X F: SOT-89 G: SOT-223 H: SOP	A: 8 T: 3 V: 5	080: 0.8V
B 1. GND <small>(SOT-223)</small> 2. OUT <small>(SOT-23)</small> 3. IN <small>(SOT-89)</small>			090: 0.9V
			100: 1.0V
			110: 1.1V
			120: 1.2V
C 1. GND <small>(SOT-89)</small> 2. IN 3. OUT	130: 1.3V		
	140: 1.4V		
	150: 1.5V		
A 1. IN <small>(SOT-25)</small> 2. GND 3. EN 4. BYP 5. OUT	:	:	
	:	:	
A 1. IN <small>(SOP-8)</small> 2. GND 3. GND 4. OUT 5. NC 6. GND 7. GND 8. EN	420: 4.2V		
	430: 4.3V		

AME8855
■ Absolute Maximum Ratings

Parameter		Maximum	Unit
Input Voltage		-0.3 to 6	V
EN Voltage		-0.3 to 6	V
Output Current		$P_D/(V_{IN}-V_{OUT})$	mA
Output Voltage		GND-0.3 to $V_{IN}+0.3$	V
ESD Classification	HBM	2	kV
	MM	200	V

Caution: Stress above the listed in absolute maximum ratings may cause permanent damage to the device.

■ Recommended Operating Conditions

Parameter	Symbol	Rating	Unit
Ambient Temperature Range	T_A	- 40 to +85	°C
Junction Temperature Range	T_J	- 40 to +125	°C
Storage Temperature Range	T_{STG}	- 65 to +150	°C

■ Thermal Information

Parameter	Package	Die Attach	Symbol	Maximum	Unit
Thermal Resistance* (Junction to Case)	SOT-89	Conductive Epoxy	θ_{JC}	40	°C / W
		Non-Conductive Epoxy		46	
	SOT-223	Conductive Epoxy		25	
		Non-Conductive Epoxy		31	
	SOT-23	Non-Conductive Epoxy		140	
	SOT-25	Conductive Epoxy		81	
	SOP-8	Conductive Epoxy		60	
Thermal Resistance (Junction to Ambient)	SOT-89	Conductive Epoxy	θ_{JA}	180	°C / W
		Non-Conductive Epoxy		180	
	SOT-223	Conductive Epoxy		120	
		Non-Conductive Epoxy		135	
	SOT-23	Non-Conductive Epoxy		280	
	SOT-25	Conductive Epoxy		260	
	SOP-8	Conductive Epoxy		150	
Internal Power Dissipation	SOT-89	Conductive Epoxy	P_D	550	mW
		Non-Conductive Epoxy		550	
	SOT-223	Conductive Epoxy		900	
		Non-Conductive Epoxy		800	
	SOT-23	Non-Conductive Epoxy		400	
	SOT-25	Conductive Epoxy		400	
	SOP-8	Conductive Epoxy		810	
Maximum Junction Temperature				150	°C
Lead Temperature (Soldering, 10Sec.)**				260	°C

* Measure θ_{JC} on backside center of molding compound if IC has no tab.

** MIL-STD-202G 210F

AME8855

■ Electrical Specifications

$V_{IN} = V_{OUT(NOM)} + 1V$, (for $V_{OUT} < 2V$, $V_{IN} = 2.8V$), $I_{OUT} = 1mA$, and $C_{OUT} = 1\mu F$, $C_{IN} = 1\mu F$ unless otherwise noted.
Typical values are at $T_A = 25^\circ C$.

Parameter	Symbol	Test Condition	Min	Typ	Max	Units
Input Voltage	V_{IN}		2.8		5.5	V
Output Accuracy	$V_{OUT,ACC}$	$I_{OUT} = 1mA$	-2.0		2.0	%
Output Voltage Range	V_{OUT}		0.8		4.3	V
Dropout Voltage (Note 1)	V_{DROP}	$I_{OUT} = 600mA$, $0.8V < V_{OUT(NOM)} < 2.0V$			Note2	mV
		$I_{OUT} = 600mA$, $2.0V < V_{OUT(NOM)} < 2.8V$			850	
		$I_{OUT} = 600mA$, $2.8V < V_{OUT(NOM)}$		420	650	
Output Current	I_{OUT}		600			mA
Quiescent Current	I_Q	$I_{OUT} = 0mA$		60	90	μA
Line Regulation $\frac{\Delta V_{OUT}}{\Delta V_{IN}} \times 100\%$ $\frac{\Delta V_{OUT}}{V_{OUT}}$	REG _{LINE}	$I_{OUT} = 1mA$, $0.8V < V_{OUT} < 1.2V$, $2.8V < V_{IN} < 3.5V$		0.125	0.25	% / V
		$I_{OUT} = 1mA$, $1.2V < V_{OUT} < 2.0V$, $2.8V < V_{IN} < 3.5V$		0.1	0.2	
		$I_{OUT} = 1mA$, $2.0V < V_{OUT} < 4.2V$, $V_{IN(MIN)} < V_{IN} < V_{IN(MIN)} + 1V$		0.05	0.1	
		$I_{OUT} = 1mA$, $4.2V < V_{OUT} < 4.5V$, $V_{IN(MIN)} < V_{IN} < 5.5V$ (Note2)		0.05	0.1	
Load Regulation $\frac{\Delta V_{OUT}}{V_{OUT}} \times 100\%$ $\frac{\Delta V_{OUT}}{\Delta I_{OUT}}$	REG _{LOAD}	$1mA < I_{OUT} < 600mA$ $0.8V < V_{OUT(NOM)} < 1.2V$		1.5	3	% / A
		$1mA < I_{OUT} < 600mA$ $1.2V < V_{OUT(NOM)} < 2.0V$		1.25	2.5	
		$1mA < I_{OUT} < 600mA$ $2.0V < V_{OUT(NOM)}$		1.0	2.0	

AME8855
■ Electrical Specifications (Contd.)

Parameter	Symbol	Test Condition	Min	Typ	Max	Units	
Power Supply Rejection Ratio	PSRR	$C_{OUT}=1\mu F, V_{OUT}=0.8V$ $I_{OUT}=10mA$ $V_{IN}=2.8V$	F=100Hz		60		dB
			F=1KHz		60		
			F=10KHz		60		
Output Voltage Noise	eN	$I_{OUT}=10mA, V_{OUT}=0.8V,$ f=1Hz to 100KHz		100		μV_{RMS}	
Enable High (Enabled)	$V_{EN,HI}$	$V_{IN(MIN)} V_{IN} 5.5V$	1.4		V_{IN}	V	
Enable Low (Shutdown)	$V_{EN,LO}$	$V_{IN(MIN)} V_{IN} 5.5V$	0		0.4		
Enable Input Bias Current	$I_{EN,HI}$	$V_{EN}=V_{IN}$			1	μA	
	$I_{EN,LO}$	$V_{EN}=0V$			2		
Shutdown Current	I_{SHDN}	$V_{IN}=5.0V, V_{EN}=0V$		0.1	1	μA	
Shutdown Output Voltage	$V_{OUT,SD}$	$I_{OUT}=0.4mA, V_{EN}=0V$			0.4	V	
Protection							
Output Current Limit	I_{LIM}	$V_{OUT}=0.9 \times V_{OUT(NOM)}$	750			mA	
Short-Circuit Current	I_{SC}	$V_{OUT} 0.6V$		300			
Thermal Shutdown Temperature	T_{SHDN}	Shutdown, temperature increasing		150		$^{\circ}C$	
Thermal Shutdown Hysteresis	$T_{SHDN(HYS)}$			20			

Note1: Dropout Voltage is measured at $V_{OUT}=V_{OUT(NOM)} \times 98\%$

Note2: For V_{OUT} below 2.0V, Dropout Voltage is the Input(MIN) Voltage to Output Voltage differential.

AME8855

■ Detailed Description

The AME8855 family of CMOS regulators contain a PMOS pass transistor, voltage reference, error amplifier, over-current protection thermal shutdown, and Power Good detection circuitry.

The P-channel pass transistor receives data from the error amplifier, over-current shutdown, and thermal protection circuits. During normal operation, the error amplifier compares the output voltage to a precision reference. Over-current and Thermal shutdown circuits become active when the junction temperature exceeds 150°C, or the current exceeds 600mA. During thermal shutdown, the output voltage remains low. Normal operation is restored when the junction temperature drops more 20°C.

Capacitor Selection and Regulator Stability

The AME8855 is stable with an output capacitor to ground of 1μF or greater. Ceramic capacitors have the lowest ESR, and will offer the best AC performance. Conversely, Aluminum Electrolytic capacitors exhibit the highest ESR, resulting in the poorest AC response. Unfortunately, large value ceramic capacitors are comparatively expensive. One option is to parallel a 0.1μF ceramic capacitor with a 10μF Aluminum Electrolytic. The benefit is low ESR, high capacitance, and low overall cost.

A second capacitor is recommended between the input and ground to stabilize V_{IN} . The input capacitor should be at least 0.1μF to have a beneficial effect.

Enable Pin

The Enable Pin is normally pull-high. When activated pulled low, the MOS pass transistor shuts off, and all internal circuits are powered down. In this state, the stand by current is than 1μA.

Capacitor Selection and Regulator Stability

The maximum output power of the AME8855 is limited by the maximum power dissipation of the package. By calculation the power dissipation of the package as a function of the input voltage, output voltage and output current, the maximum input voltage can be obtained. The maximum power dissipation should not exceed the package' s maximum power rating.

$$P_{MAX} = (V_{IN(MAX)} - V_{OUT}) \times I_{OUT}$$

Where:

$V_{IN(MAX)}$ = maximum input voltage

P_{MAX} = maximum power dissipation of the package

AME8855

■ Characterization Curve

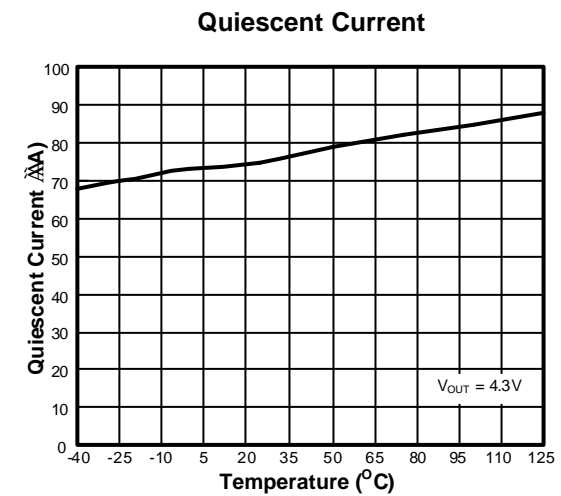
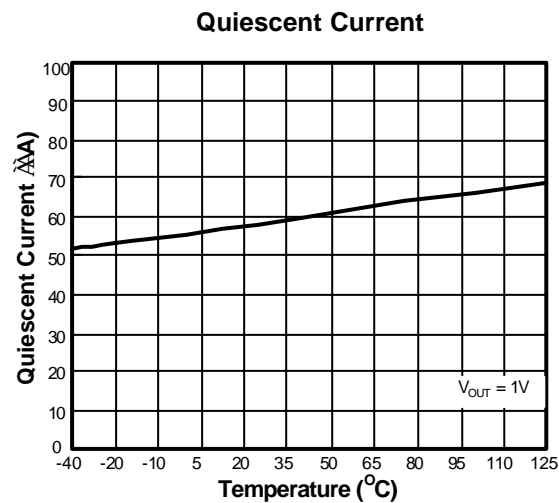
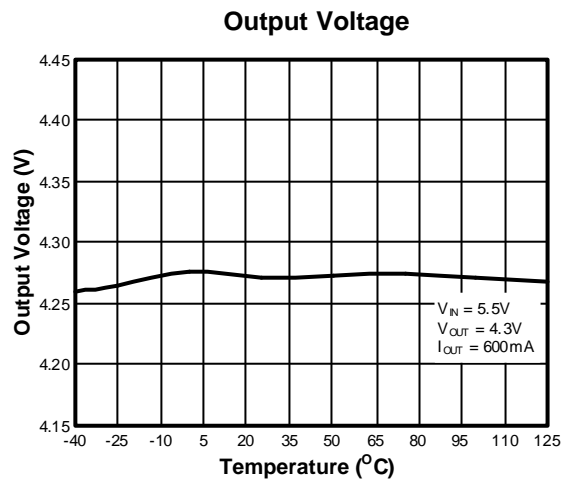
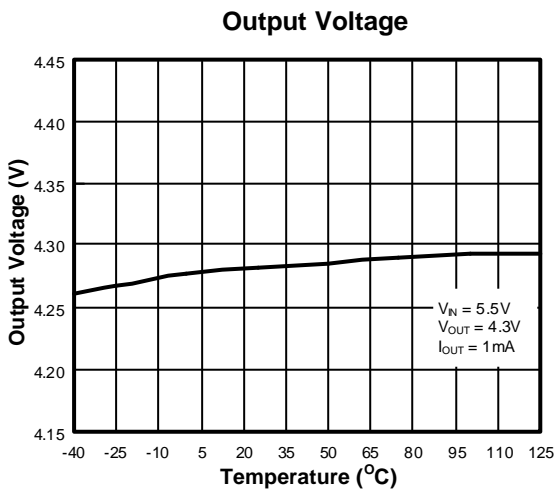
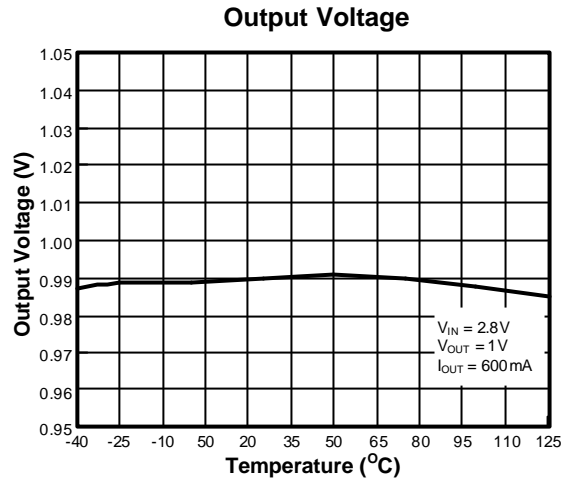
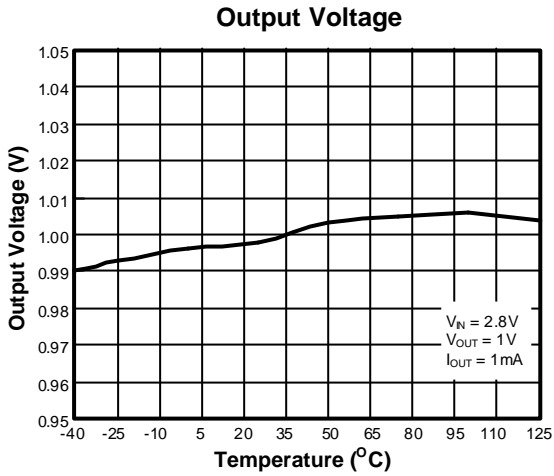

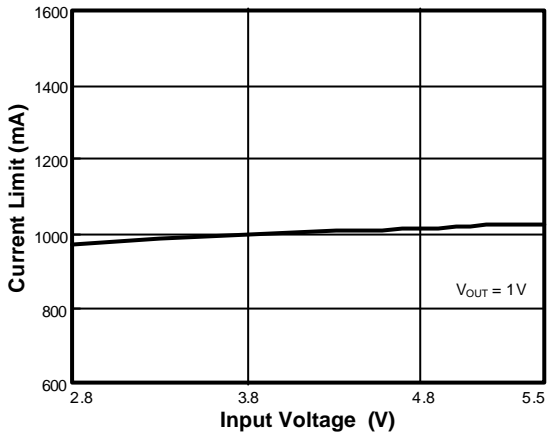
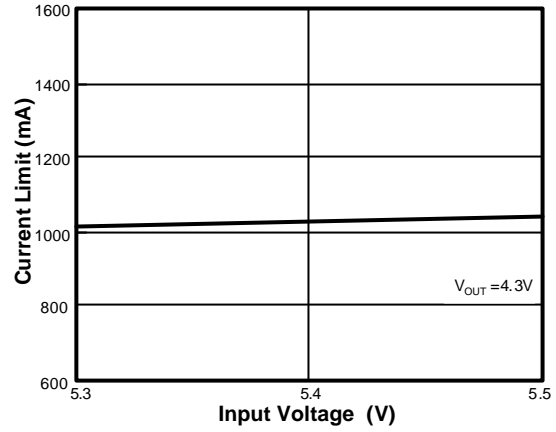
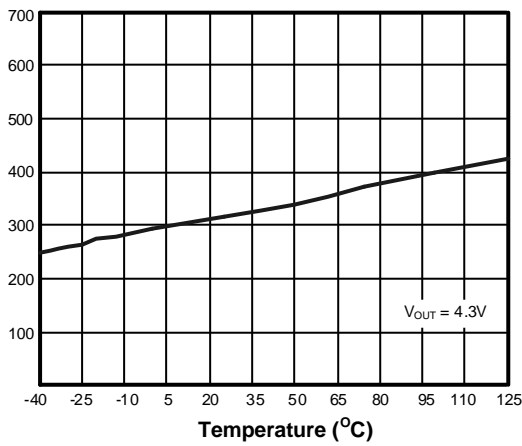
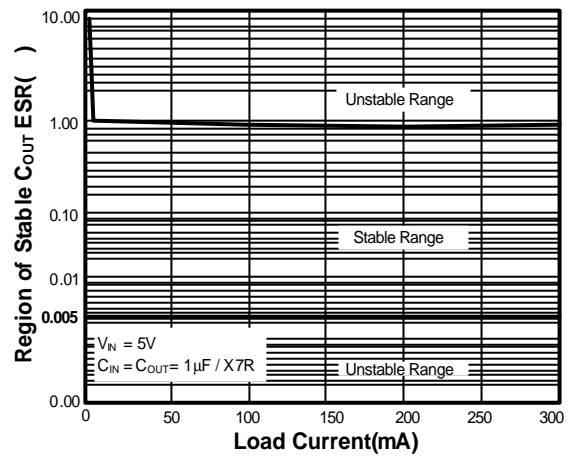
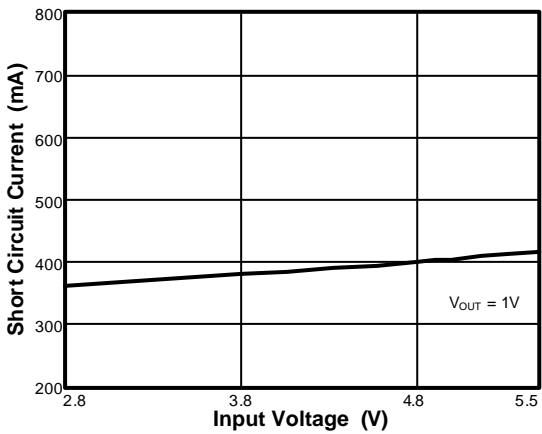
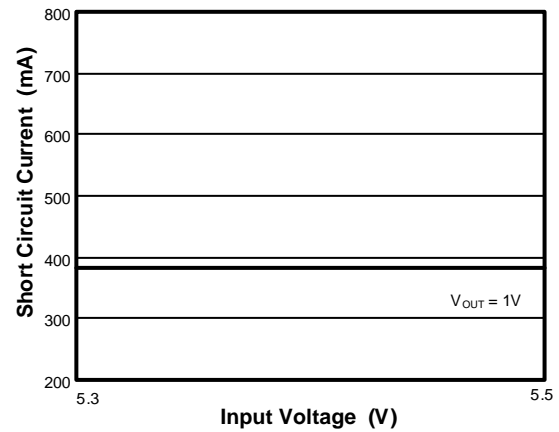
■ Characterization Curve (Contd.)
Current Limit vs Input Voltage

Current Limit vs Input Voltage

Dropout Voltage

Stability vs. ESR vs. Load Current

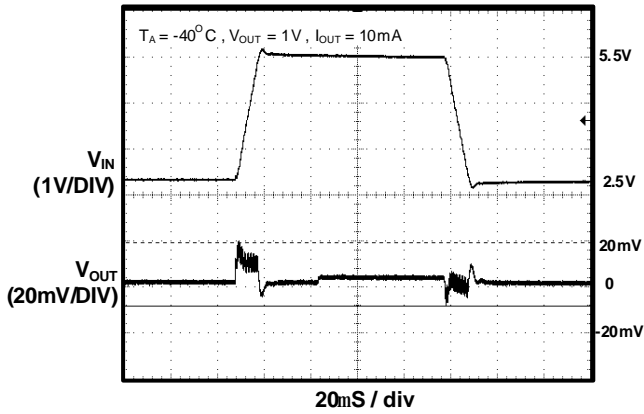
Short Circuit Current Protection

Short Circuit Current Protection

AME8855

■ Characterization Curve (Contd.)

Line Transient Response



Line Transient Response

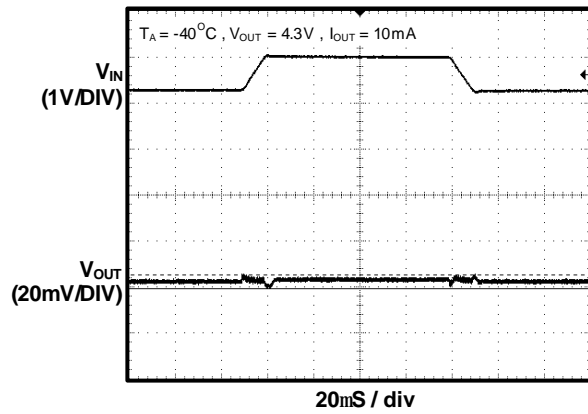

Line Transient Response

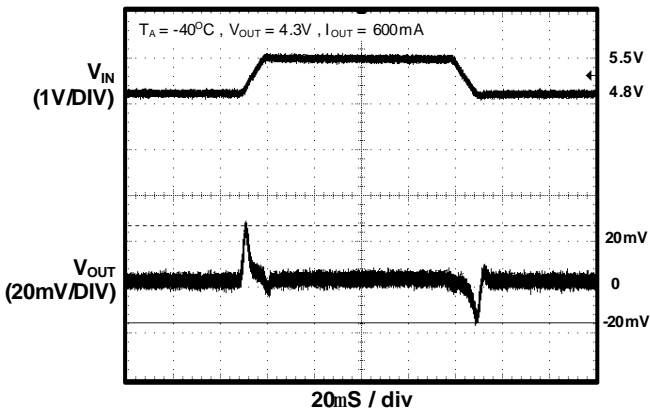

Line Transient Response

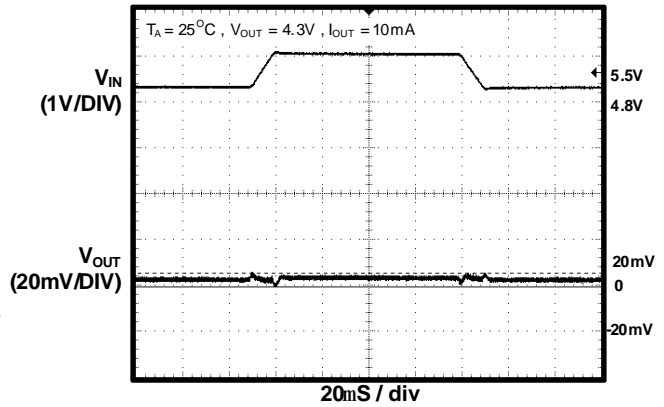

Line Transient Response

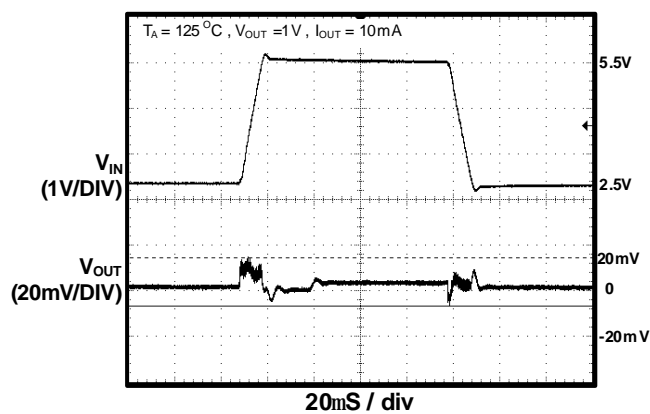

Line Transient Response

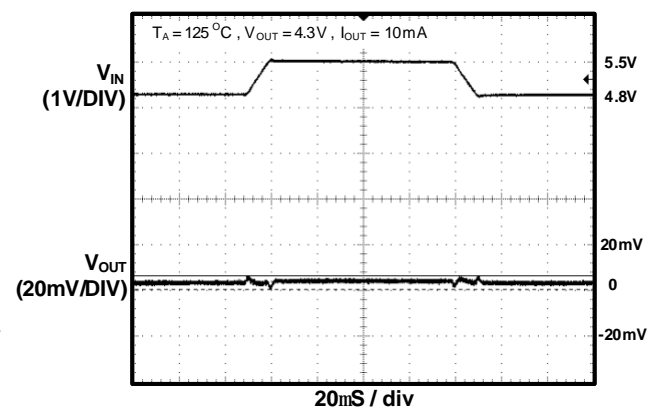

AME8855

■ Characterization Curve (Contd.)

Line Transient Response

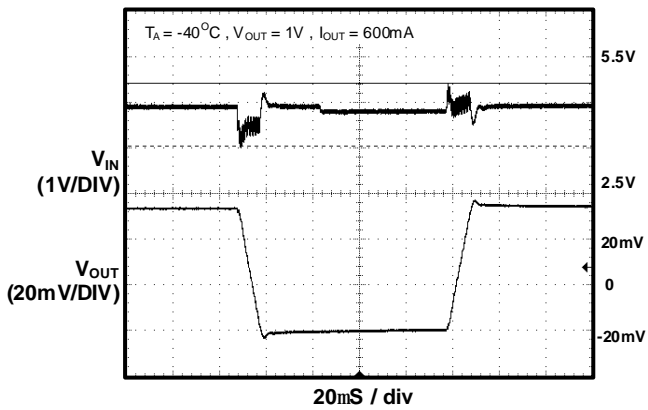

Line Transient Response

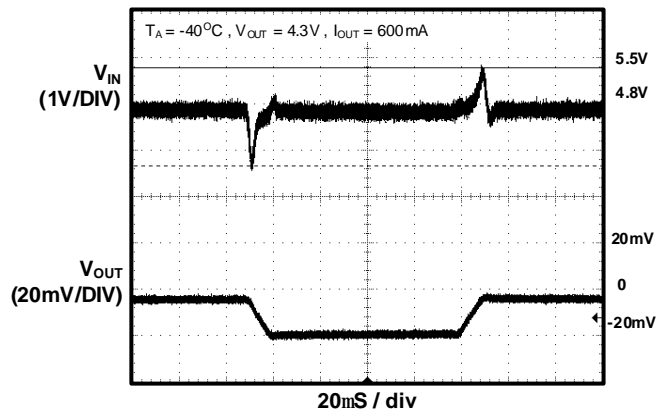

Line Transient Response

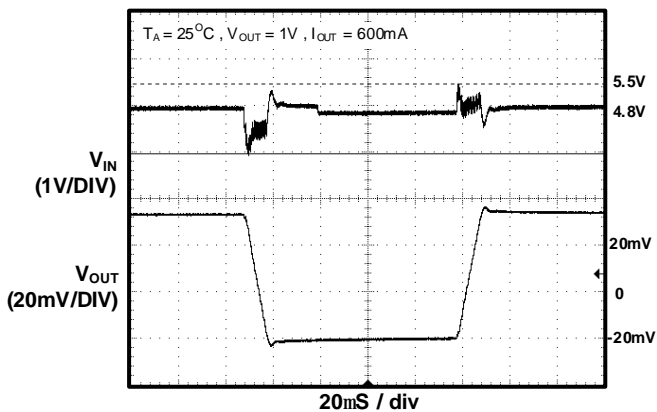

Line Transient Response

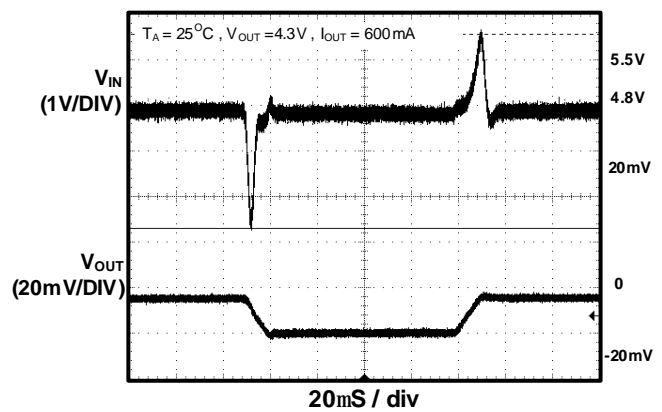

Line Transient Response

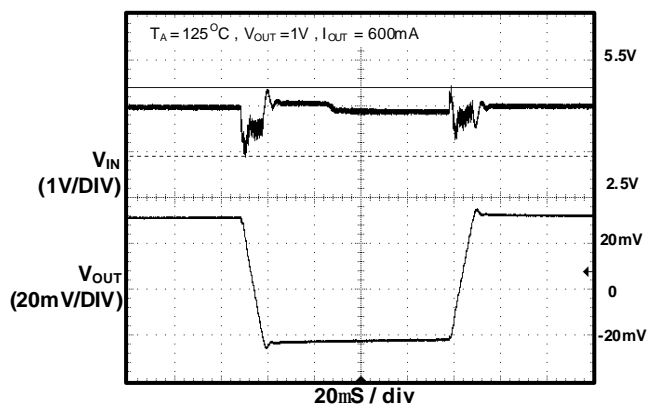

Line Transient Response

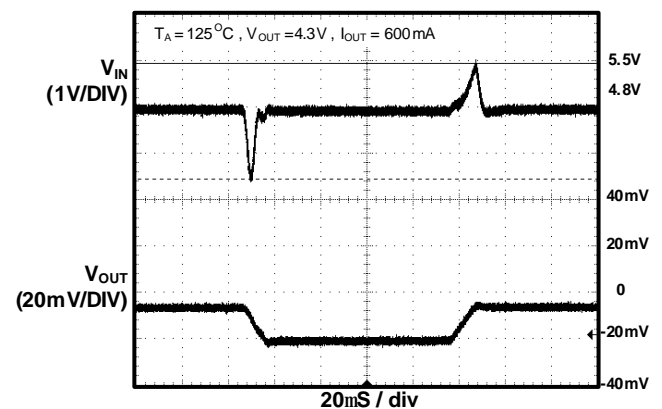

AME8855

■ Characterization Curve (Contd.)

Load Transient Response

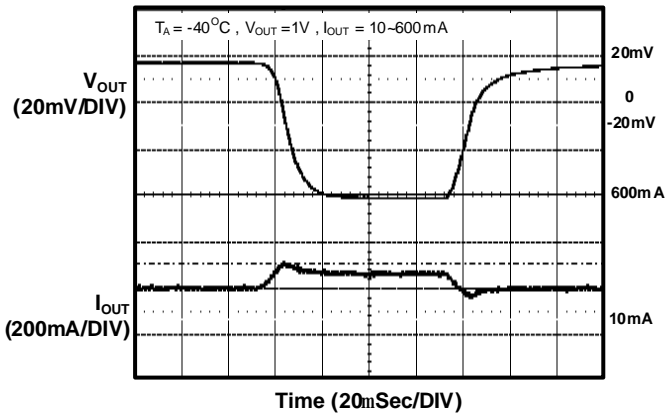

Load Transient Response

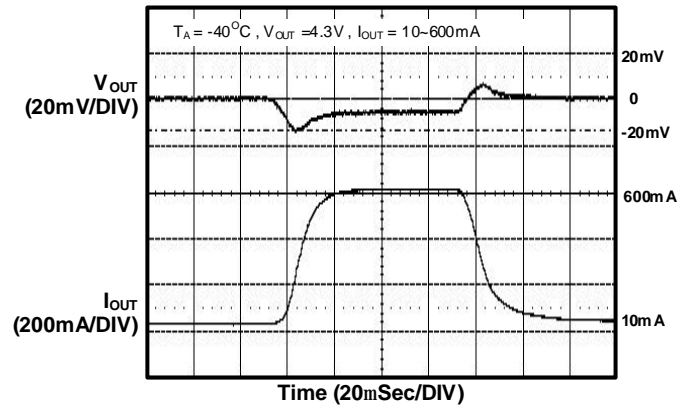

Load Transient Response

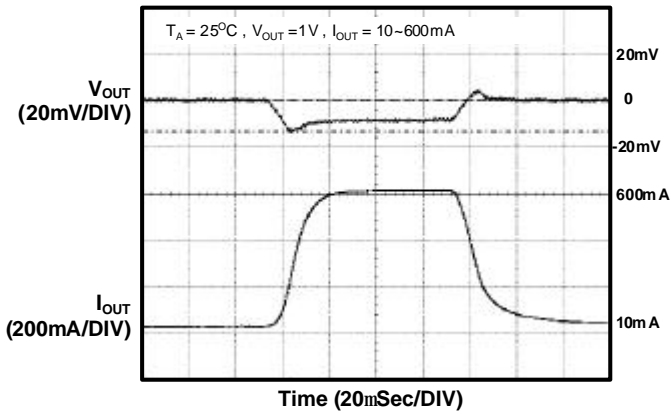

Load Transient Response

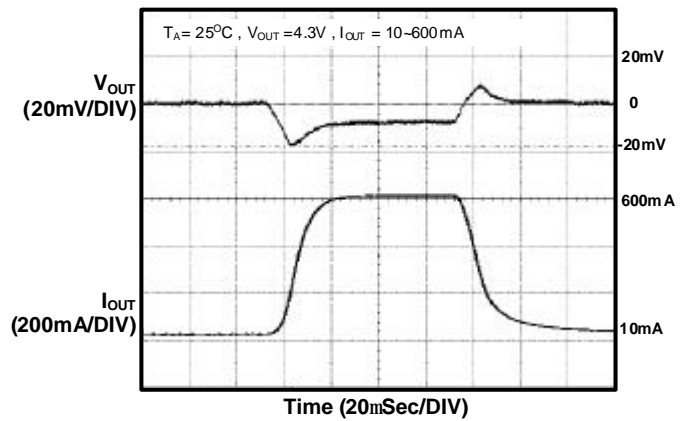

Load Transient Response

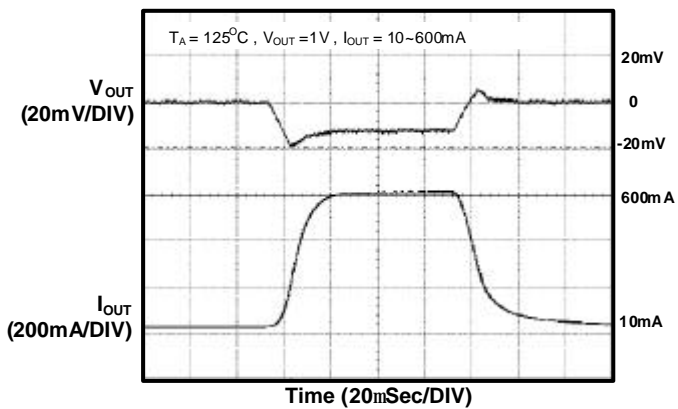

Load Transient Response

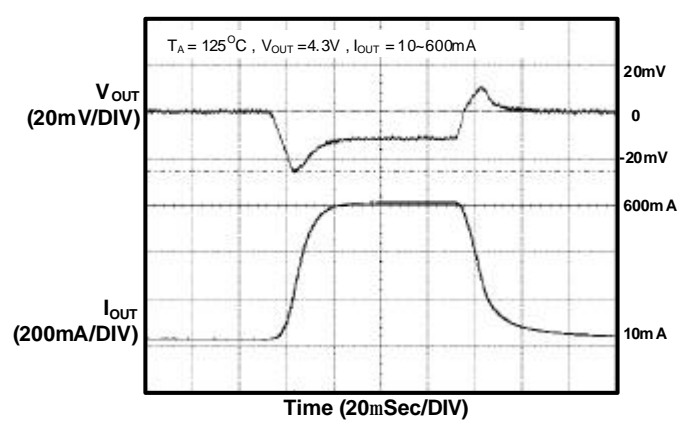

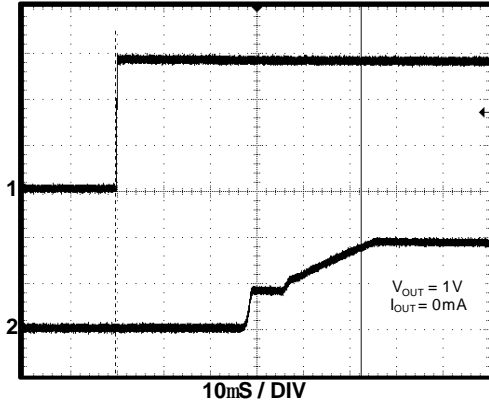
AME8855
■ Characterization Curve (Contd.)
Chip Enable Transient Response

- 1) EN= 2V/div
- 2) V_{OUT} = 500mV/div

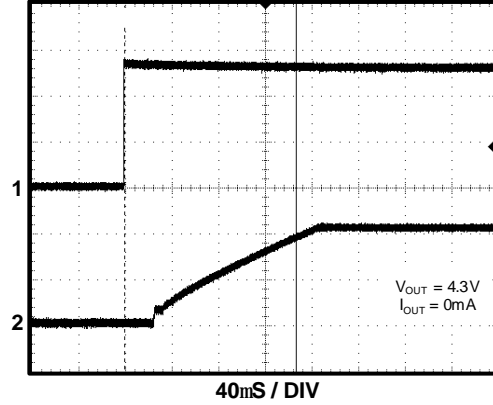
Chip Enable Transient Response

- 1) EN= 2V/div
- 2) V_{OUT} = 2V/div

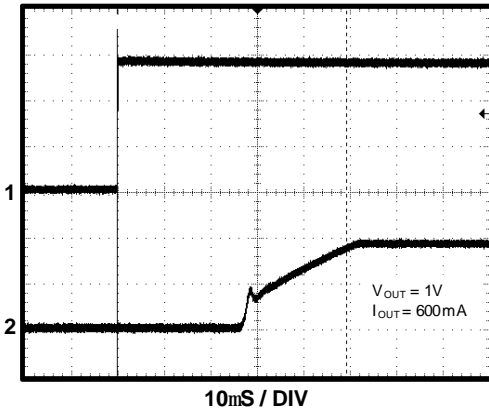
Chip Enable Transient Response

- 1) EN= 1V/div
- 2) V_{OUT} = 500mV/div

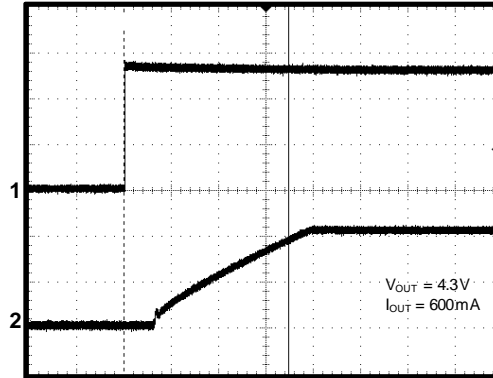
Chip Enable Transient Response

- 1) EN= 2V/div
- 2) V_{OUT} = 2V/div

■ Characterization Curve (Contd.)

Shut down curve Output Voltage

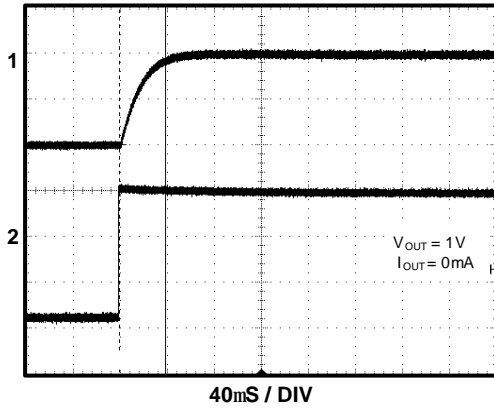

- 1) EN= 1V/div
- 2) V_{OUT} = 500mV/div

Shut down curve Output Voltage

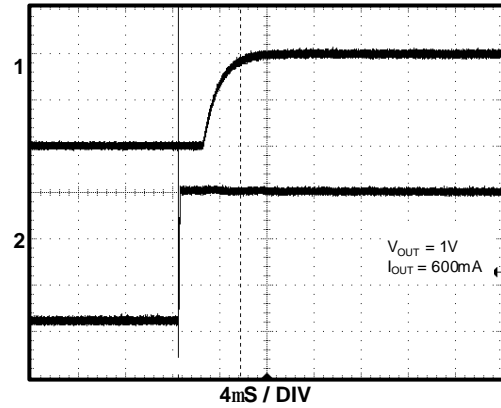

- 1) EN= 1V/div
- 2) V_{OUT} = 500mV/div

Shut down curve Output Voltage

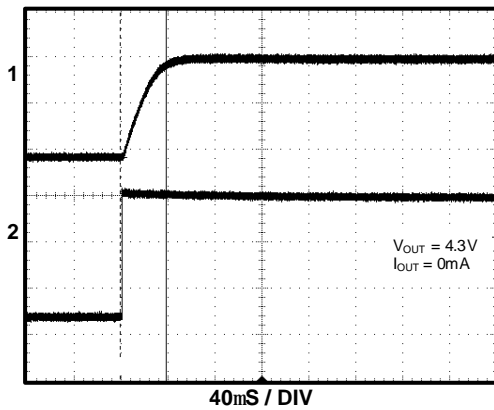

- 1) EN= 2V/div
- 2) V_{OUT} = 2V/div

Shut down curve Output Voltage

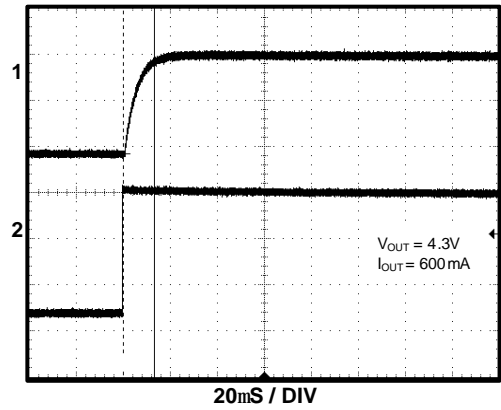

- 1) EN= 2V/div
- 2) V_{OUT} = 2V/div

AME8855**■ Characterization Curve (Contd.)**

PSRR vs Frequency

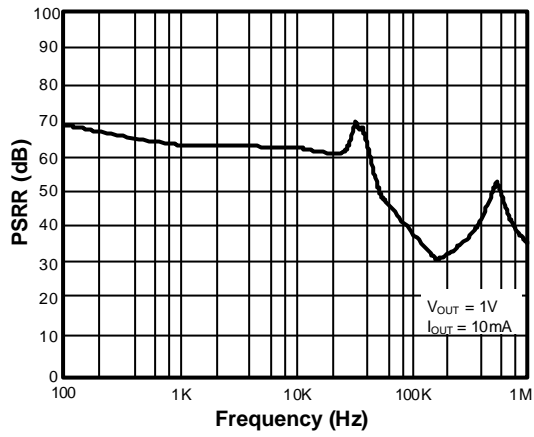

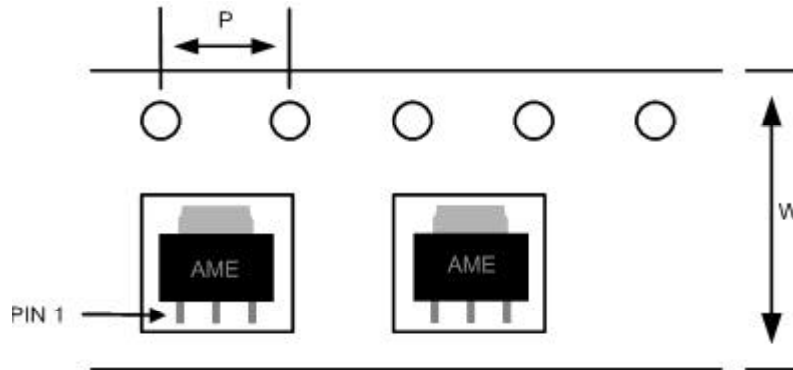
AME8855
■ Tape and Reel Dimension
SOT-223

Carrier Tape, Number of Components Per Reel and Reel Size

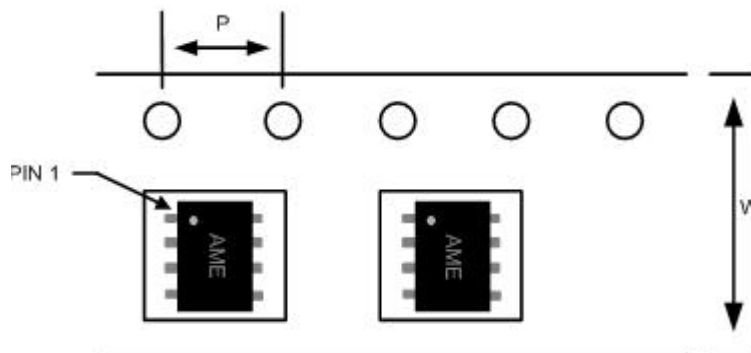
Package	Carrier Width (W)	Pitch (P)	Part Per Full Reel	Reel Size
SOT-223	12.0±0.1 mm	4.0±0.1 mm	2500pcs	330±1 mm

SOP-8

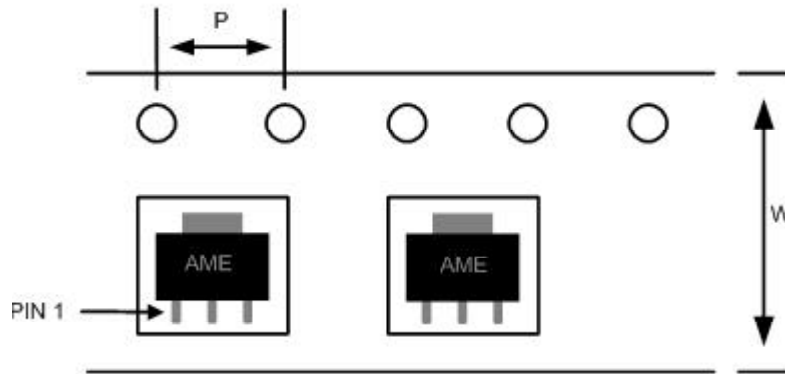
Carrier Tape, Number of Components Per Reel and Reel Size

Package	Carrier Width (W)	Pitch (P)	Part Per Full Reel	Reel Size
SOP-8	12.0±0.1 mm	4.0±0.1 mm	2500pcs	330±1 mm

AME8855
■ Tape and Reel Dimension (Contd.)
SOT-89

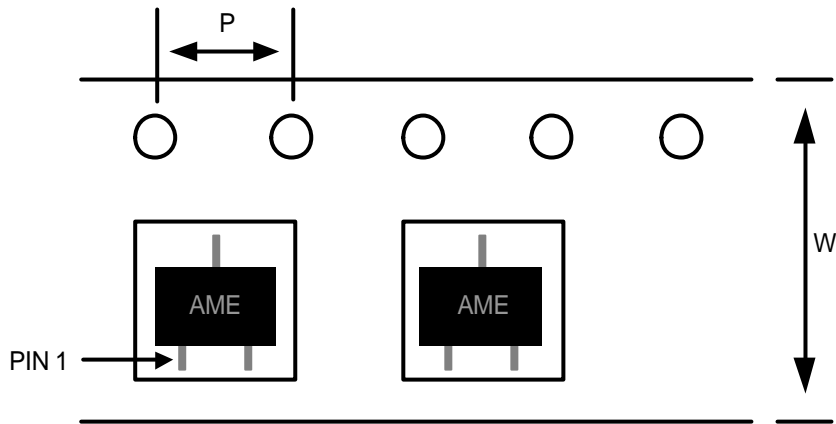
Carrier Tape, Number of Components Per Reel and Reel Size

Package	Carrier Width (W)	Pitch (P)	Part Per Full Reel	Reel Size
SOT-89	12.0±0.1 mm	4.0±0.1 mm	1000pcs	180±1 mm

AME8855
■ Tape and Reel Dimension (Contd.)
SOT-23

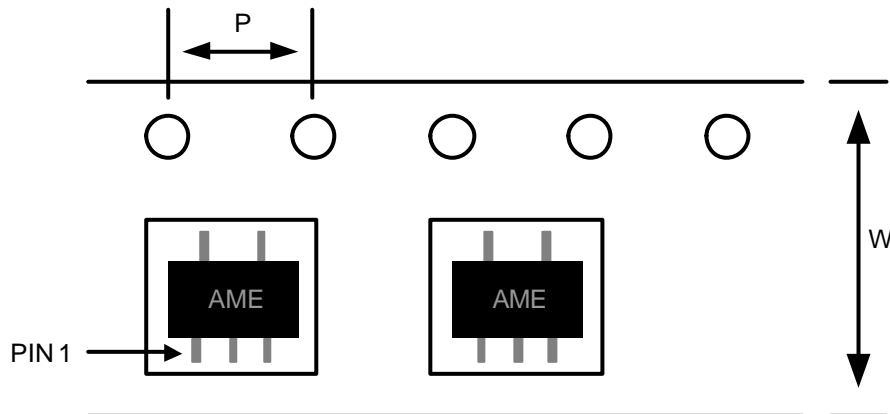
Carrier Tape, Number of Components Per Reel and Reel Size

Package	Carrier Width (W)	Pitch (P)	Part Per Full Reel	Reel Size
SOT-23	8.0±0.1 mm	4.0±0.1 mm	3000pcs	180±1 mm

SOT-25

Carrier Tape, Number of Components Per Reel and Reel Size

Package	Carrier Width (W)	Pitch (P)	Part Per Full Reel	Reel Size
SOT-25	8.0±0.1 mm	4.0±0.1 mm	3000pcs	180±1 mm

AME8855

■ Package Dimension

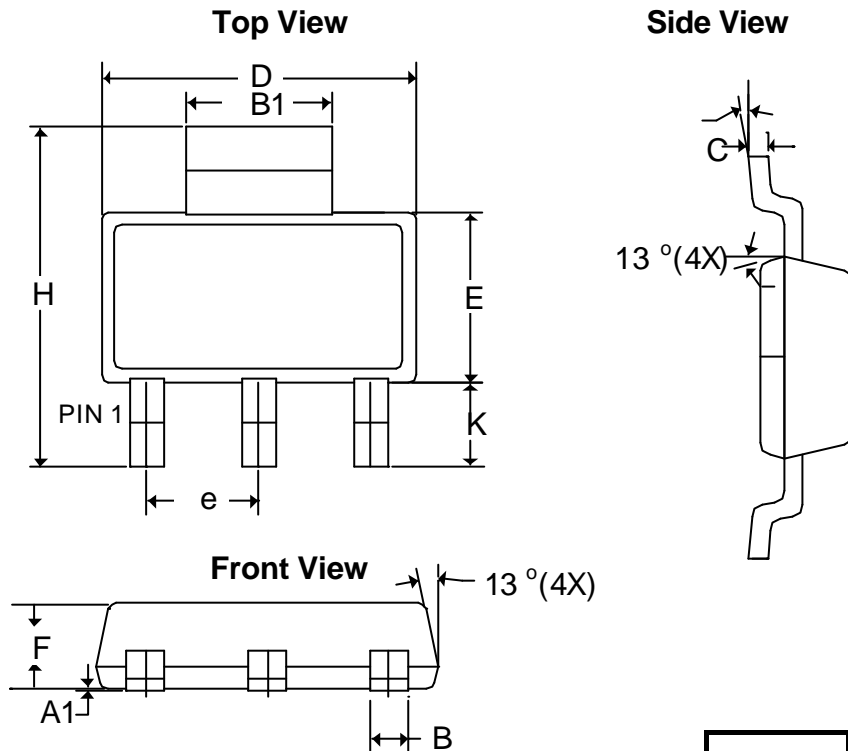
SOT-223



SYMBOLS	MILLIMETERS		INCHES	
	MIN	MAX	MIN	MAX
A ₁	0.01	0.10	0.0004	0.0039
B	0.60	0.84	0.0236	0.0330
B ₁	2.90	3.15	0.1140	0.1240
C	0.23	0.38	0.0091	0.0150
D	6.20	6.71	0.2441	0.2640
E	3.30	3.71	0.1299	0.1460
e	2.30 BSC		0.0906 BSC	
F	1.40	1.80	0.0551	0.0709
H	6.70	7.30	0.2638	0.2874
K	1.665	1.669	0.0656	0.0657
q	0°	10°	0°	10°

AME8855

■ Package Dimension (Contd.)

SOP-8

Top View

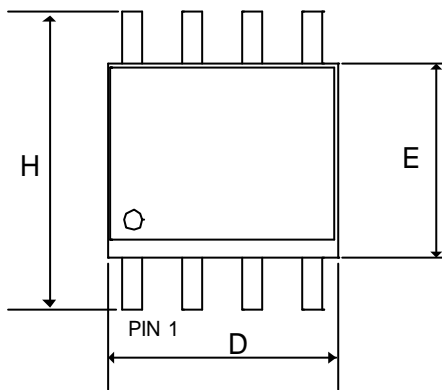

Side View

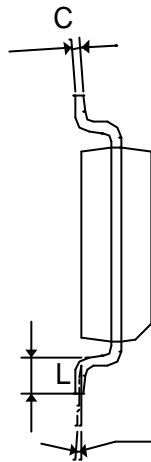

Front View

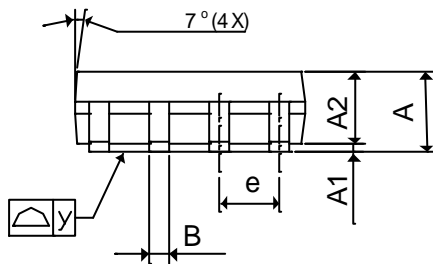

SYMBOLS	MILLIMETERS		INCHES	
	MIN	MAX	MIN	MAX
A	1.35	1.75	0.0531	0.0689
A ₁	0.10	0.30	0.0039	0.0118
A ₂	1.473 REF		0.0580 REF	
B	0.33	0.51	0.0130	0.0201
C	0.17	0.25	0.0067	0.0098
D	4.70	5.33	0.1850	0.2098
E	3.80	4.00	0.1496	0.1575
e	1.27 BSC		0.0500 BSC	
L	0.40	1.27	0.0157	0.0500
H	5.80	6.30	0.2283	0.2480
y	-	0.10	-	0.0039
q	0°	8°	0°	8°

AME8855

■ Package Dimension (Contd.)

SOT-89

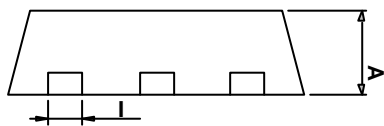
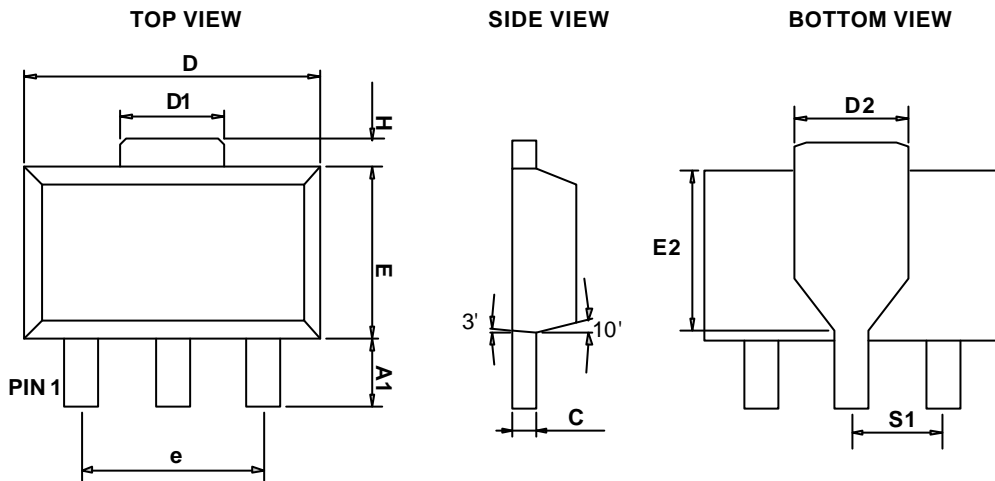

FRONT VIEW

SYMBOLS	MILLIMETERS		INCHES	
	MIN	MAX	MIN	MAX
A	1.39	1.60	0.0547	0.0630
A ₁	0.8 REF		0.0315 REF	
C	0.35	0.44	0.0138	0.0173
D	4.39	4.60	0.1728	0.1811
D ₁	1.35	1.83	0.0531	0.0720
E	2.28	2.60	0.0898	0.1024
I	0.32	0.56	0.0126	0.0220
e	3.00 REF		0.1181 REF	
H	0.70 REF		0.0276 REF	
S ₁	1.50 REF		0.0591 REF	
E ₂	2.05	2.60	0.0807	0.1024
D ₂	1.50	1.85	0.0591	0.0728

AME8855

■ Package Dimension (Contd.)

SOT-25

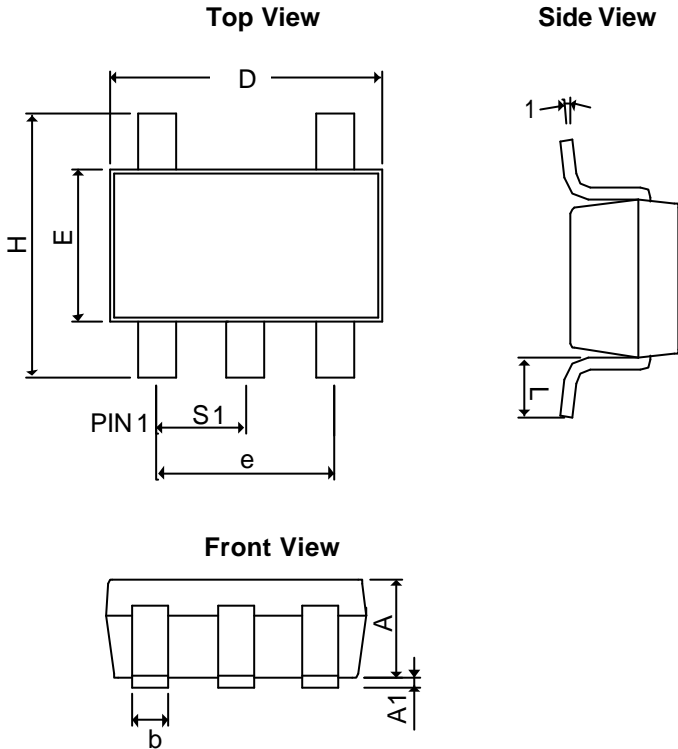

SYMBOLS	MILLIMETERS		INCHES	
	MIN	MAX	MIN	MAX
A	0.90	1.30	0.0354	0.0512
A ₁	0.00	0.15	0.0000	0.0059
b	0.30	0.55	0.0118	0.0217
D	2.70	3.10	0.1063	0.1220
E	1.40	1.80	0.0551	0.0709
e	1.90 BSC		0.0748 BSC	
H	2.60	3.00	0.1024	0.1181
L	0.37 BSC		0.0146 BSC	
q1	0°	10°	0°	10°
S ₁	0.95 BSC		0.0374 BSC	

AME8855

■ Package Dimension (Contd.)

SOT-23

Top View

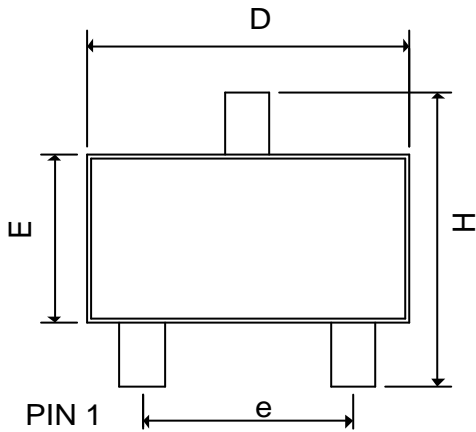

Side View

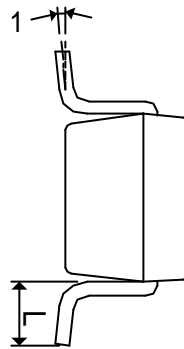

Front View

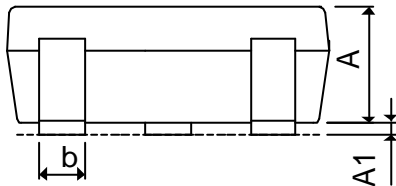

SYMBOLS	MILLIMETERS		INCHES	
	MIN	MAX	MIN	MAX
A	0.90	1.40	0.0354	0.0551
A₁	0.00	0.15	0.0000	0.0059
b	0.30	0.50	0.0118	0.0197
D	2.70	3.10	0.1063	0.1220
E	1.40	1.80	0.0551	0.0709
e	1.90 BSC		0.0748 BSC	
H	2.40	3.00	0.0945	0.1181
L	0.35BSC		0.0138 BSC	
q1	0°	10°	0°	10°

AME8855

■ Lead Pattern

SOT-223

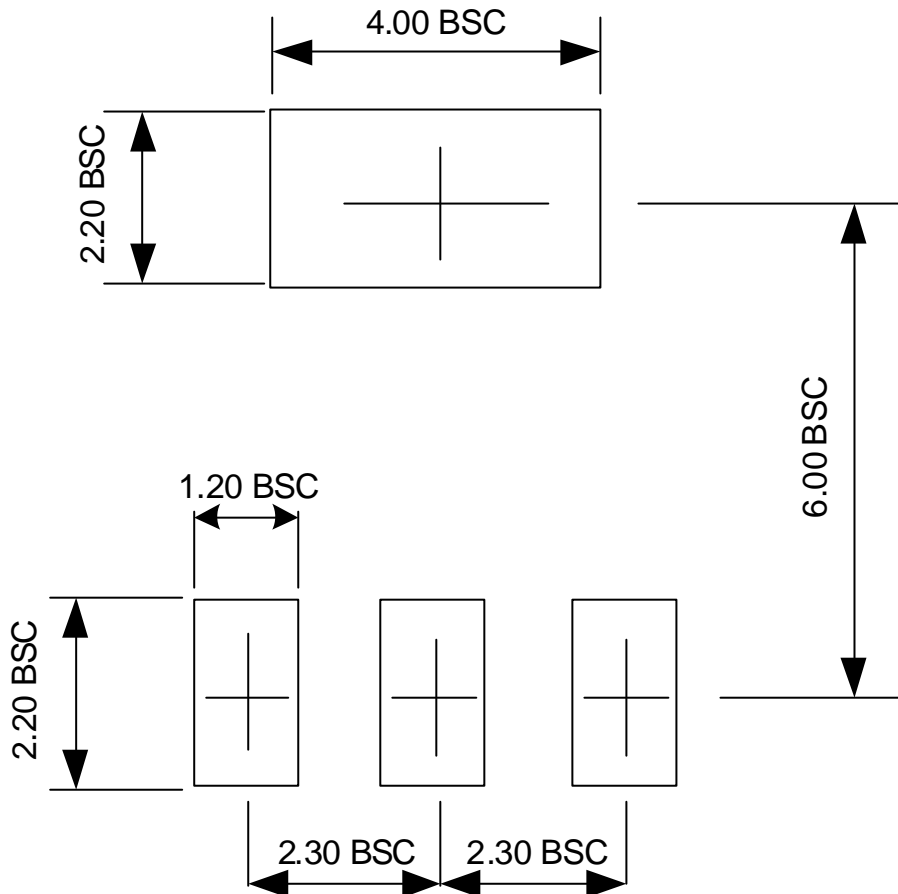

Note:

1. Lead pattern unit description:

BSC: Basic. Represents theoretical exact dimension or dimension target.

2. Dimensions in Millimeters.

3. General tolerance $\pm 0.05\text{mm}$ unless otherwise specified.

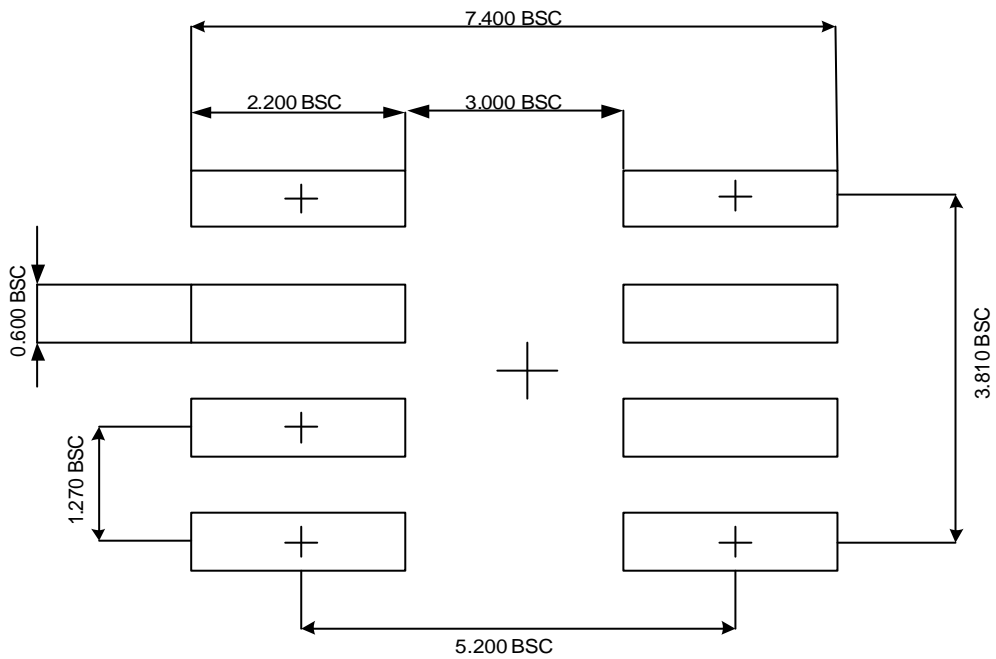
AME8855
Lead Pattern
SOP-8

Note:

1. Lead pattern unit description:

BSC: Basic. Represents theoretical exact dimension or dimension target.

2. Dimensions in Millimeters.

3. General tolerance $\pm 0.05\text{mm}$ unless otherwise specified.

AME8855

■ Lead Pattern

SOT-89

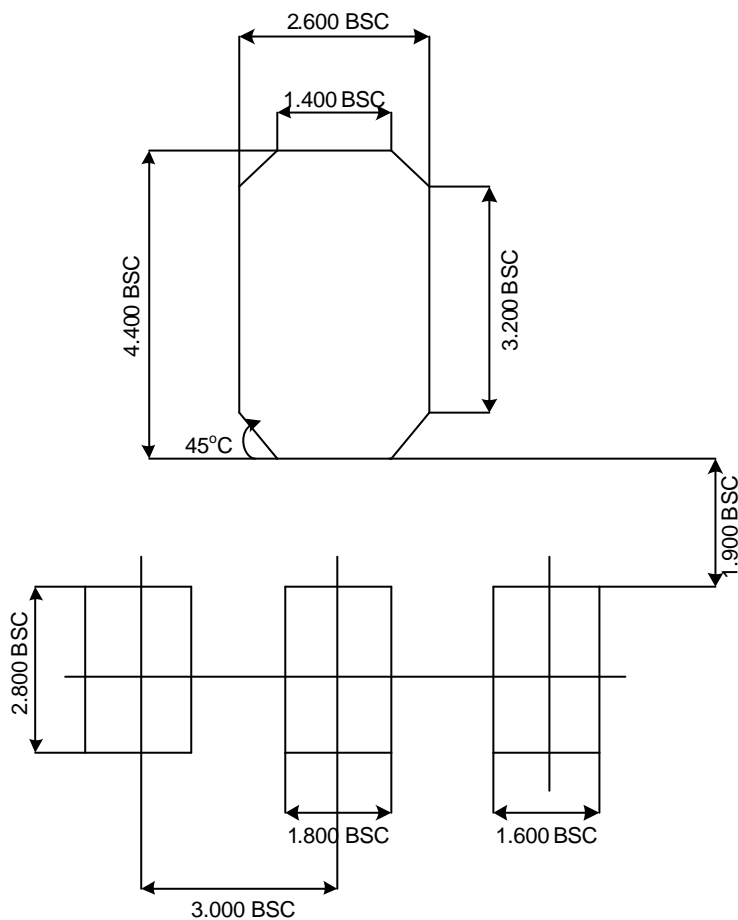

Note:

1. Lead pattern unit description:

BSC: Basic. Represents theoretical exact dimension or dimension target.

2. Dimensions in Millimeters.

3. General tolerance $\pm 0.05\text{mm}$ unless otherwise specified.

AME8855

■ Lead Pattern

SOT-25

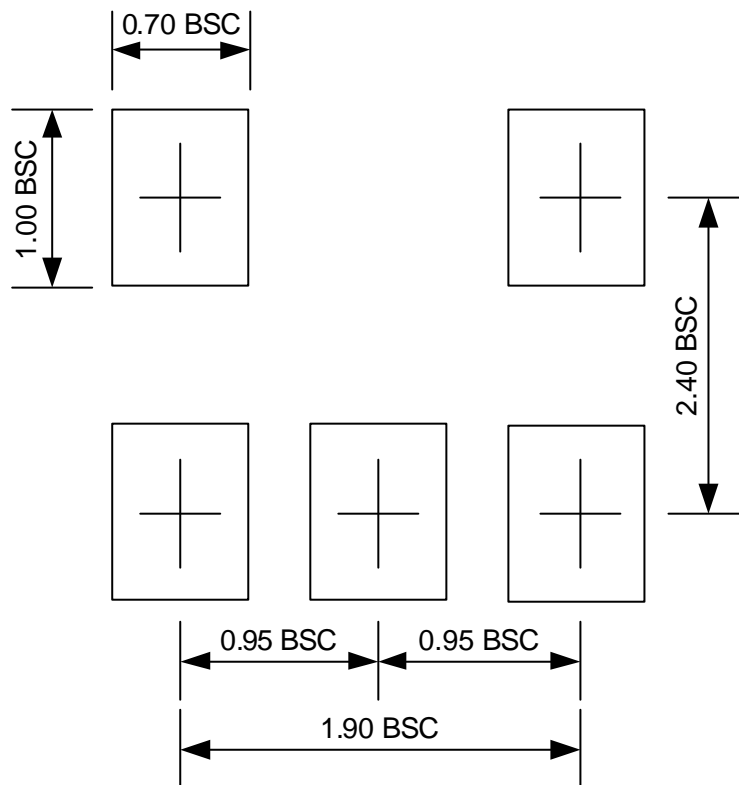

Note:

1. Lead pattern unit description:

BSC: Basic. Represents theoretical exact dimension or dimension target.

2. Dimensions in Millimeters.

3. General tolerance $\pm 0.05\text{mm}$ unless otherwise specified.

AME8855**■ Lead Pattern**

SOT-23

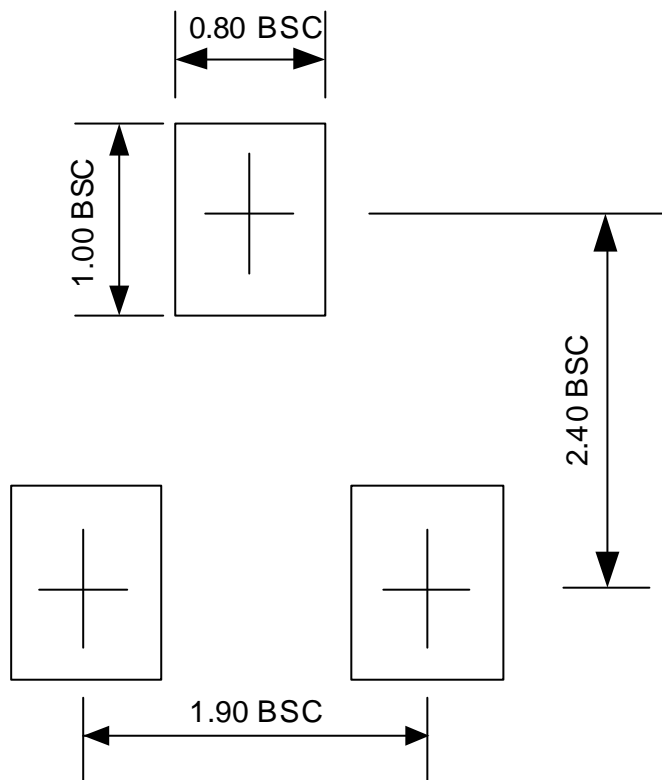

Note:

1. Lead pattern unit description:

BSC: Basic. Represents theoretical exact dimension or dimension target.

2. Dimensions in Millimeters.

3. General tolerance $\pm 0.05\text{mm}$ unless otherwise specified.



www.ame.com.tw
E-Mail: sales@ame.com.tw

Life Support Policy:

These products of AME, Inc. are not authorized for use as critical components in life-support devices or systems, without the express written approval of the president of AME, Inc.

AME, Inc. reserves the right to make changes in the circuitry and specifications of its devices and advises its customers to obtain the latest version of relevant information.

© AME, Inc. , January 2013

Document: TM001-DS8855-C.02

Corporate Headquarter
AME, Inc.

8F, 12, WenHu St., Nei Hu

Taipei, Taiwan. 114

Tel: 886 2 2627-8687

Fax: 886 2 2659-2989